



the ARLES

星凱·堤岸

| SALES BROCHURE 售樓說明書 |



You are advised to take the following steps before purchasing first-hand residential properties.

For all first-hand residential properties

1. Important information

- Make reference to the materials available on the Sales of First-hand Residential Properties Electronic Platform (SRPE) (www.srpe.gov.hk) on the first-hand residential property market.
- Study the information on the website designated by the vendor for the development, including the sales brochure, price lists, documents containing the sales arrangements, and the register of transactions of a development.
- Sales brochure for a development will be made available to the general public at least 7 days immediately before a date of sale while price list and sales arrangements will be made available at least 3 days immediately before the date of sale.
- Information on transactions can be found on the register of transactions on the website designated by the vendor for the development and the SRPE.

2. Fees, mortgage loan and property price

- Calculate the total expenses of the purchase, such as solicitors' fees, mortgage charges, insurance fees and stamp duties.
- Check with banks to find out if you will be able to obtain the needed mortgage loan, select the appropriate payment method and calculate the amount of the mortgage loan to ensure it is within your repayment ability.
- Check recent transaction prices of comparable properties for comparison.
- Check with the vendor or the estate agent the estimated management fee, the amount of management fee payable in advance (if any), special fund payable (if any), the amount of reimbursement of the deposits for water, electricity and gas (if any), and/or the amount of debris removal fee (if any) you have to pay to the vendor or the manager of the development.

3. Price list, payment terms and other financial incentives

- Vendors may not offer to sell all the residential properties that are covered in a price list. To know which residential properties the vendors may offer to sell, pay attention to the sales arrangements which will be announced by the vendors at least 3 days before the relevant residential properties are offered to be sold.
- Pay attention to the terms of payment as set out in a price list. If there are discounts on the price, gift, or any financial advantage or benefit to be made available in connection with the purchase of the residential properties, such information will also be set out in the price list.
- If you intend to opt for any mortgage loan plans offered by financial institutions specified by the vendor, before entering

into a preliminary agreement for sale and purchase (PASP), you must study the details of various mortgage loan plans¹ as set out in the price list concerned. If you have any questions about these mortgage loan plans, you should check with the financial institutions concerned direct before entering into a PASP.

4. Property area and its surroundings

- Pay attention to the area information in the sales brochure and price list, and price per square foot/metre in the price list. According to the Residential Properties (First-hand Sales) Ordinance (Cap. 621) (the Ordinance), vendors can only present the area and price per square foot and per square metre of a residential property using saleable area. Saleable area, in relation to a residential property, means the floor area of the residential property, and includes the floor area of every one of the following to the extent that it forms part of the residential property - (i) a balcony; (ii) a utility platform; and (iii) a verandah. The saleable area excludes the area of the following which forms part of the residential property - air-conditioning plant room; bay window; cockloft; flat roof; garden; parking space; roof; stairhood; terrace and yard.
- Floor plans of all residential properties in the development have to be shown in the sales brochure. In a sales brochure, floor plans of residential properties in the development must state the external and internal dimensions of each residential property². The external and internal dimensions of residential properties as provided in the sales brochure exclude plaster and finishes. You are advised to note this if you want to buy furniture before handing over of the residential property.
- Visit the development site and get to know the surroundings of the property (including transportation and community facilities). Check town planning proposals and decisions which may affect the property. Take a look at the location plan, aerial photograph, outline zoning plan and cross-section plan that are provided in the sales brochure.

5. Sales brochure

- Ensure that the sales brochure obtained is the latest version. According to the Ordinance, the sales brochure made available to the public should be printed or examined, or examined and revised within the previous 3 months.
- In respect of an uncompleted development, the vendor may alter the building plans (if any) whenever the vendor considers necessary. To know the latest information of an uncompleted development, keep paying attention to any revised sales brochures made available by the vendor.
- Read through the sales brochure and in particular, check the following information in the sales brochure –
 - whether there is a section on “relevant information” in the sales brochure, under which information on any matter that is known to the vendor but is not known to the general public, and is likely to materially affect the enjoyment of a residential

property will be set out. Please note that information contained in a document that has been registered with the Land Registry will not be regarded as “relevant information”;

- the cross-section plan showing a cross-section of the building in relation to every street adjacent to the building, and the level of every such street in relation to a known datum and to the level of the lowest residential floor of the building. This will help you visualize the difference in height between the lowest residential floor of a building and the street level, regardless of how that lowest residential floor is named;
- interior and exterior fittings and finishes and appliances;
- the basis on which management fees are shared;
- whether individual owners have obligations or need to share the expenses for managing, operating and maintaining the public open space or public facilities inside or outside the development, and the location of the public open space or public facilities; and
- whether individual owners have responsibility to maintain slopes.

6. Government land grant and deed of mutual covenant (DMC)

- Read the Government land grant and the DMC (or the draft DMC). Information such as ownership of the rooftop and external walls can be found in the DMC. The vendor will provide copies of the Government land grant and the DMC (or the draft DMC) at the place where the sale is to take place for free inspection by prospective purchasers.
- Check the Government land grant on whether individual owners are liable to pay Government rent.
- Check the DMC on whether animals can be kept in the residential property.

7. Information on Availability of Residential Properties for Selection at Sales Office

- Check with the vendor which residential properties are available for selection. If a “consumption table” is displayed by the vendor at the sales office, you may check from the table information on the progress of sale on a date of sale, including which residential properties are offered for sale at the beginning of that date of sale and which of them have been selected and sold during that date of sale.
- Do not believe in rumours about the sales condition of the development and enter into a PASP rashly.

8. Register of Transactions

- Pay attention to the register of transactions for a development. A vendor must, within 24 hours after entering into a PASP with a purchaser, enter transaction information of the PASP in the register of transactions. The vendor must, within 1 working day after entering into an agreement for sale and purchase (ASP), enter

transaction information of the ASP in the register of transactions. Check the register of transactions for the concerned development to learn more about the sales condition of the development.

- Never take the number of registrations of intent or cashier orders a vendor has received for the purpose of registration as an indicator of the sales volume of a development. The register of transactions for a development is the most reliable source of information from which members of the public can grasp the daily sales condition of the development.

9. Agreement for sale and purchase

- Ensure that the PASP and ASP include the mandatory provisions as required by the Ordinance.
- Pay attention that fittings, finishes and appliances to be included in the sale and purchase of the property are inserted in the PASP and ASP.
- Pay attention to the area plan annexed to the ASP which shows the total area which the vendor is selling to you. The total area which the vendor is selling to you is normally greater than the saleable area of the property.
- Pay attention to the vendor's right to alter the building plans (if any) for an uncompleted development. The mandatory provisions to be incorporated in an ASP for uncompleted development as required by the Ordinance include a provision requiring the vendor to notify the purchaser in writing of such alteration if the same affects in any way the property within 14 days after its having been approved by the Building Authority.
- A preliminary deposit of **5%** of the purchase price is payable by you to the owner (i.e. the seller) on entering into a PASP.
- If you do not execute the ASP within **5 working days** (working day means a day that is not a general holiday or a Saturday or a black rainstorm warning day or gale warning day) after entering into the PASP, the PASP is terminated, the preliminary deposit (i.e. 5 % of the purchase price) is forfeited, and the owner (i.e. the seller) does not have any further claim against you for not executing the ASP.
- If you execute the ASP within 5 working days after the signing of the PASP, the owner (i.e. the seller) must execute the ASP within 8 working days after entering into the PASP.
- The deposit should be made payable to the solicitors' firm responsible for stakeholding purchasers' payments for the property.

10. Expression of intent of purchasing a residential property

- Note that vendors (including their authorized representative(s)) should not seek or accept any specific or general expression of intent of purchasing any residential property before the relevant price lists for such properties are made available to the public. You therefore should not make such an offer to the vendors or their authorized representative(s).

- Note that vendors (including their authorized representative(s)) should not seek or accept any specific expression of intent of purchasing a particular residential property before the sale of the property has commenced. You therefore should not make such an offer to the vendors or their authorized representative(s).

11. Appointment of estate agent

- Note that if the vendor has appointed one or more than one estate agents to act in the sale of any specified residential property in the development, the price list for the development must set out the name of all the estate agents so appointed as at the date of printing of the price list.
- You may appoint any estate agent (not necessarily from those estate agency companies appointed by the vendor) to act in the purchase of any specified residential property in the development, and may also not appoint any estate agent to act on your behalf.
- Before you appoint an estate agent to look for a property, you should -
 - find out whether the agent will act on your behalf only. If the agent also acts for the vendor, he/she may not be able to protect your best interests in the event of a conflict of interest;
 - find out whether any commission is payable by you to the estate agent and, if so, its amount and the time of payment; and
 - note that only licensed estate agents or salespersons may accept your appointment. If in doubt, you should request the estate agent or salesperson to produce his/her Estate Agent Card, or check the Licence List on the Estate Agents Authority website: www.eaa.org.hk.

12. Appointment of solicitor

- Consider appointing your own solicitor to protect your interests. If the solicitor also acts for the vendor, he/she may not be able to protect your best interests in the event of a conflict of interest.
- Compare the charges of different solicitors.

For first-hand uncompleted residential properties

13. Pre-sale Consent

- For uncompleted residential property under the Lands Department Consent Scheme, seek confirmation from the vendor whether the "Pre-sale Consent" has been issued by the Lands Department for the development.

14. Show flats

- While the vendor is not required to make any show flat available for viewing by prospective purchasers or the general public, if the vendor wishes to make available show flats of a specified residential property, the vendor must first of all make available an unmodified show flat of that residential property and that, having made available such unmodified show flat, the vendor may then make available a modified show flat of that residential property.

In this connection, the vendor is allowed to make available more than one modified show flat of that residential property.

- If you visit the show flats, you should always look at the unmodified show flats for comparison with the modified show flats. That said, the Ordinance does not restrict the discretion of the vendor in arranging the sequence of the viewing of unmodified and modified show flats.
- Sales brochure of the development should have been made available to the public when the show flat is made available for viewing. You are advised to get a copy of the sales brochure and make reference to it when viewing the show flats.
- You may take measurements in modified and unmodified show flats, and take photographs or make video recordings of unmodified show flats, subject to reasonable restriction(s) which may be set by the vendor for ensuring safety of the persons viewing the show flat.

For first-hand uncompleted residential properties and completed residential properties pending compliance

15. Estimated material date and handing over date

- Check the estimated material date³ for the development in the sales brochure.
 - The estimated material date for a development in the sales brochure is not the same as the date on which a residential property is handed over to purchaser. The latter is normally later than the former. However, the handing over date may be earlier than the estimated material date set out in the sales brochure in case of earlier completion of the development.
- Handing over date
 - The mandatory provisions to be incorporated in an ASP as required by the Ordinance include a provision requiring the vendor to apply in writing for an Occupation Document / a Certificate of Compliance or the Director of Lands' Consent to Assign (as the case may be) in respect of the development within 14 days after the estimated material date as stipulated in the ASP.
 - For development subject to the Lands Department Consent Scheme, the vendor is required to notify the purchaser in writing that the vendor is in a position validly to assign the property within one month after the issue of the Certificate of Compliance or the Consent to Assign, whichever first happens; or
 - For development not subject to the Lands Department Consent Scheme, the vendor is required to notify the purchaser in writing that the vendor is in a position validly to assign the property within 6 months after the issue of the Occupation Document including Occupation Permit.
 - The mandatory provisions to be incorporated in an ASP as required by the Ordinance include a provision requiring

completion of the sale and purchase within 14 days after the date of the notification aforesaid. Upon completion, the vendor shall arrange handover of the property to the purchaser.

- Authorized Person (AP) may grant extension(s) of time for completion of the development beyond the estimated material date.
 - The mandatory provisions to be incorporated in an ASP as required by the Ordinance include a provision that the AP of a development may grant an extension of time for completion of the development beyond the estimated material date having regard to delays caused exclusively by any one or more of the following reasons:
 - strike or lock-out of workmen;
 - riots or civil commotion;
 - force majeure or Act of God;
 - fire or other accident beyond the vendor's control;
 - war; or
 - inclement weather.
 - The AP may grant more than once such an extension of time depending on the circumstances. That means handover of the property may be delayed.
 - The mandatory provisions to be incorporated in an ASP as required by the Ordinance also include a provision requiring the vendor to, within 14 days after the issue of an extension of time granted by the AP, furnish the purchaser with a copy of the relevant certificate of extension.
- Ask the vendor if there are any questions on handing over date.

For first-hand completed residential properties

16. Vendor's information form

- Ensure that you obtain the "vendor's information form(s)" printed within the previous 3 months in relation to the residential property/properties you intend to purchase.

17. Viewing of property

- Ensure that, before you purchase a residential property, you are arranged to view the residential property that you would like to purchase or, if it is not reasonably practicable to view the property in question, a comparable property in the development, unless you agree in writing that the vendor is not required to arrange such a comparable property for viewing for you. You are advised to think carefully before signing any waiver.
- You may take measurements, take photographs or make video recordings of the property, unless the property is held under a tenancy or reasonable restriction(s) is/are needed to ensure safety of the persons viewing the property.

For complaints and enquiries relating to the sales of first-hand residential properties by the vendors which the Ordinance applies, please contact the Sales of First-hand Residential Properties Authority -

Website : www.srpa.gov.hk
 Telephone : 2817 3313
 Email : enquiry_srpa@hd.gov.hk
 Fax : 2219 2220

Other useful contacts:

Consumer Council
 Website : www.consumer.org.hk
 Telephone : 2929 2222
 Email : cc@consumer.org.hk
 Fax : 2856 3611

Estate Agents Authority
 Website : www.eaa.org.hk
 Telephone : 2111 2777
 Email : enquiry@eaa.org.hk
 Fax : 2598 9596

Real Estate Developers Association of Hong Kong
 Telephone : 2826 0111
 Fax : 2845 2521

Sales of First-hand Residential Properties Authority
 Transport and Housing Bureau
 July 2021

Notes:

1. The details of various mortgage loan plans include the requirements for mortgagors on minimum income level, the loan limit under the first mortgage and second mortgage, the maximum loan repayment period, the change of mortgage interest rate throughout the entire repayment period, and the payment of administrative fees.
2. According to section 10(2)(d) in Part 1 of Schedule 1 to the Ordinance, each of the floor plans of the residential properties in the development in the sales brochure must state the following—
 - (i) the external dimensions of each residential property;
 - (ii) the internal dimensions of each residential property;
 - (iii) the thickness of the internal partitions of each residential property;
 - (iv) the external dimensions of individual compartments in each residential property.
 According to section 10(3) in Part 1 of Schedule 1 to the Ordinance, if any information required by section 10(2)(d) in Part 1 of Schedule 1 to the Ordinance is provided in the approved building plans for the development, a floor plan must state the information as so provided.

3. Generally speaking, "material date" means the date on which the conditions of the land grant are complied with in respect of the development, or the date on which the development is completed in all respects in compliance with the approved building plans or the conditions subject to which the certificate of exemption is issued. For details, please refer to section 2 of the Ordinance.

您在購置一手住宅物業之前，應留意下列事項：

適用於所有一手住宅物業

1. 重要資訊

- 瀏覽一手住宅物業銷售資訊網（下稱「銷售資訊網」）（網址：www.srpe.gov.hk），參考「銷售資訊網」內有關一手住宅物業的市場資料。
- 閱覽賣方就該發展項目所指定的互聯網網站內的有關資訊，包括售樓說明書、價單、載有銷售安排的文件，及成交紀錄冊。
- 發展項目的售樓說明書，會在該項目的出售日期前最少七日向公眾發布，而有關價單和銷售安排，亦會在該項目的出售日期前最少三日公布。
- 在賣方就有關發展項目所指定的互聯網網站，以及「銷售資訊網」內，均載有有關物業成交資料的成交紀錄冊，以供查閱。

2. 費用、按揭貸款和樓價

- 計算置業總開支，包括律師費、按揭費用、保險費，以及印花稅。
- 向銀行查詢可否取得所需的按揭貸款，然後選擇合適的還款方式，並小心計算按揭貸款金額，以確保貸款額沒有超出本身的負擔能力。
- 查閱同類物業最近的成交價格，以作比較。
- 向賣方或地產代理瞭解，您須付予賣方或該發展項目的管理人的預計的管理費、管理費上期金額（如有）、特別基金金額（如有）、補還的水、電力及氣體按金（如有），以及/或清理廢料的費用（如有）。

3. 價單、支付條款，以及其他財務優惠

- 賣方未必會把價單所涵蓋的住宅物業悉數推售，因此應留意有關的銷售安排，以了解賣方會推售的住宅物業為何。賣方會在有關住宅物業推售日期前最少三日公布銷售安排。
- 留意價單所載列的支付條款。倘買家可就購置有關住宅物業而連帶獲得價格折扣、贈品，或任何財務優惠或利益，上述資訊亦會在價單內列明。
- 如您擬選用由賣方指定的財務機構提供的各類按揭貸款計劃，在簽訂臨時買賣合約前，應先細閱有關價單內列出的按揭貸款計劃資料¹。如就該些按揭貸款計劃的詳情有任何疑問，應在簽訂臨時買賣合約前，直接向有關財務機構查詢。

4. 物業的面積及四周環境

- 留意載於售樓說明書和價單內的物業面積資料，以及載於價單內的每平方呎/每平方米售價。根據《一手住宅物業銷售條例》（第621章）（下稱「條例」），賣方只可以實用面積表達住宅物業的面積和每平方呎及平方米的售價。就住宅物業而言，實用面積指該住宅物業的樓面面積，包括在構成該物業的一部分的範圍內的以下每一項目的樓面面積：(i) 露台；(ii) 工作平台；以及 (iii) 陽台。實用面積並不包括空調機房、窗台、閣樓、平台、花園、停車位、天台、梯

屋、前庭及庭院的每一項目的面積，即使該些項目構成該物業的一部分的範圍。

- 售樓說明書必須顯示發展項目中所有住宅物業的樓面平面圖。在售樓說明書所載有關發展項目中住宅物業的每一份樓面平面圖，均須述明每個住宅物業的外部及內部尺寸²。售樓說明書所提供有關住宅物業外部及內部的尺寸，不會把批盪和裝飾物料包括在內。買家收樓前如欲購置家具，應留意這點。
- 親臨發展項目的所在地實地視察，以了解有關物業的四周環境（包括交通和社區設施）；亦應查詢有否任何城市規劃方案和議決，會對有關的物業造成影響；參閱載於售樓說明書內的位置圖、鳥瞰照片、分區計劃大綱圖，以及橫截面圖。

5. 售樓說明書

- 確保所取得的售樓說明書屬最新版本。根據條例，提供予公眾的售樓說明書必須是在之前的三個月之內印製或檢視、或檢視及修改。
- 如屬未落成發展項目，賣方在認為有需要時可改動建築圖則（如有的話），因此應留意由賣方提供的任何經修改的售樓說明書，以了解有關未落成發展項目的最新資料。
- 閱覽售樓說明書，並須特別留意以下資訊：
 - 售樓說明書內有否關於「有關資料」的部分，列出賣方知悉但並非為一般公眾人士所知悉，關於相當可能對享有有關住宅物業造成重大影響的事宜的資料。請注意，已在土地註冊處註冊的文件，其內容不會被視為「有關資料」；
 - 橫截面圖會顯示有關建築物相對毗連該建築物的每條街道的橫截面，以及每條上述街道與已知基準面和該建築物最低的一層住宅樓層的水平相對的水平。橫截面圖能以圖解形式，顯示出建築物最低一層住宅樓層和街道水平的高低差距，不論該最低住宅樓層以何種方式命名；
 - 室內和外部的裝置、裝修物料和設備；
 - 管理費按甚麼基準分擔；
 - 小業主有否責任或需要分擔管理、營運或維持有關發展項目以內或以外的公眾休憩用地或公共設施的開支，以及有關公眾休憩用地或公共設施的位置；以及
 - 小業主是否須要負責維修斜坡。

6. 政府批地文件和公契

- 閱覽政府批地文件和公契（或公契擬稿）。公契內載有天台和外牆業權等相關資料。賣方會在售樓處提供政府批地文件和公契（或公契擬稿）的複本，供準買家免費閱覽。
- 留意政府批地文件內所訂明小業主是否須要負責支付地稅。
- 留意公契內訂明有關物業內可否飼養動物。

7. 售樓處內有關可供揀選住宅物業的資料

- 向賣方查詢清楚有哪些一手住宅物業可供揀選。若賣方在售樓處內展示「消耗表」，您可從該「消耗表」得悉在每個銷售日的銷售進度資料，包括在該個銷售日開始時有哪些住宅物業可供出售，以及在該個銷售日內有哪些住宅物業已獲揀選及售出。
- 切勿隨便相信有關發展項目銷情的傳言，倉卒簽立臨時買賣合約。

8. 成交紀錄冊

- 留意發展項目的成交紀錄冊。賣方須於臨時買賣合約訂立後的24小時內，於紀錄冊披露該臨時買賣合約的資料，以及於買賣合約訂立後一個工作天內，披露該買賣合約的資料。您可透過成交紀錄冊得悉發展項目的銷售情況。
- 切勿將賣方接獲用作登記的購樓意向書或本票的數目視為銷情指標。發展項目的成交紀錄冊才是讓公眾掌握發展項目每日銷售情況的最可靠資料來源。

9. 買賣合約

- 確保臨時買賣合約和買賣合約包含條例所規定的強制性條文。
- 留意有關物業買賣交易所包括的裝置、裝修物料和設備，須在臨時買賣合約和買賣合約上列明。
- 留意夾附於買賣合約的圖則。該圖則會顯示所有賣方售予您的物業面積，而該面積通常較該物業的實用面積為大。
- 留意賣方有權改動未落成發展項目的建築圖則（如有的話）。如屬未落成發展項目，條例規定物業的買賣合約須載有強制性條文，列明如有關改動在任何方面對該物業造成影響，賣方須在改動獲建築事務監督批准後的14日內，將該項改動以書面通知買家。
- 訂立臨時買賣合約時，您須向擁有人（即賣方）支付樓價**5%**的臨時訂金。
- 如您在訂立臨時買賣合約後**五個工作日**（工作日指並非公眾假日、星期六、黑色暴雨警告日或烈風警告日的日子）之內，沒有簽立買賣合約，該臨時買賣合約即告終止，有關臨時訂金（即樓價的5%）會被沒收，而擁有人（即賣方）不得因您沒有簽立買賣合約而對您提出進一步申索。
- 在訂立臨時買賣合約後的五個工作日之內，倘您簽立買賣合約，則擁有人（即賣方）必須在訂立該臨時買賣合約後的八個工作日之內簽立買賣合約。

- 有關的訂金，應付予負責為所涉物業擔任保證金保存人的律師事務所。

10. 表達購樓意向

- 留意在賣方（包括其獲授權代表）就有關住宅物業向公眾提供價單前，賣方不得尋求或接納任何對有關住宅物業的購樓意向（不論是否屬明確選擇購樓意向）。因此您不應向賣方或其授權代表提出有關意向。

- 留意在有關住宅物業的銷售開始前，賣方（包括其獲授權代表）不得尋求或接納任何對該物業的有明確選擇購樓意向。因此您不應向賣方或其授權代表提出有關意向。

11. 委託地產代理

- 留意倘賣方委任一個或多於一個地產代理，以協助銷售其發展項目內任何指明住宅物業，該發展項目的價單必須列明在價單印刷日期當日所有獲委任為地產代理的姓名/名稱。
- 您可委託任何地產代理（不一定是賣方所指定的地產代理），以協助您購置發展項目內任何指明住宅物業；您亦可不委託任何地產代理。
- 委託地產代理以物色物業前，您應該 —
 - 了解該地產代理是否只代表您行事。該地產代理若同時代表賣方行事，倘發生利益衝突，未必能夠保障您的最大利益；
 - 了解您須否支付佣金予該地產代理。若須支付，有關的佣金金額和支付日期為何；以及
 - 留意只有持牌地產代理或營業員才可以接受您的委託。如有疑問，應要求該地產代理或營業員出示其「地產代理證」，或瀏覽地產代理監管局的網頁（網址：www.eaa.org.hk），查閱牌照目錄。

12. 委聘律師

- 考慮自行委聘律師，以保障您的利益。該律師若同時代表賣方行事，倘發生利益衝突，未必能夠保障您的最大利益。
- 比較不同律師的收費。

適用於一手未落成住宅物業

13. 預售樓花同意書

- 洽購地政總署「預售樓花同意方案」下的未落成住宅物業時，應向賣方確認地政總署是否已就該發展項目批出「預售樓花同意書」。

14. 示範單位

- 賣方不一定須設置示範單位供準買家或公眾參觀，但賣方如為某指明住宅物業設置示範單位，必須首先設置該住宅物業的無改動示範單位，才可設置該住宅物業的經改動示範單位，並可以就該住宅物業設置多於一個經改動示範單位。
- 參觀示範單位時，務必視察無改動示範單位，以便與經改動示範單位作出比較。然而，條例並沒有限制賣方安排參觀無改動示範單位及經改動示範單位的先後次序。
- 賣方設置示範單位供公眾參觀時，應已提供有關發展項目的售樓說明書。因此，緊記先行索取售樓說明書，以便在參觀示範單位時參閱相關資料。
- 您可以在無改動示範單位及經改動示範單位中進行量度，並在無改動示範單位內拍照或拍攝影片，惟在確保示範單位參觀者人身安全

的前提下，賣方可能會設定合理的限制。

適用於一手未落成住宅物業及尚待符合條件的已落成住宅物業

15. 預計關鍵日期及收樓日期

- 查閱售樓說明書中有關發展項目的預計關鍵日期³。
 - 售樓說明書中有關發展項目的預計關鍵日期並不同買家的「收樓日期」。買家的「收樓日期」一般會較發展項目的預計關鍵日期遲。然而，假若發展項目比預期早落成，「收樓日期」可能會較售樓說明書列出的預計關鍵日期為早。
- 收樓日期
 - 條例規定買賣合約須載有強制性條文，列明賣方須於買賣合約內列出的預計關鍵日期後的14日內，以書面為發展項目申請佔用文件、合格證明書，或地政總署署長的轉讓同意（視屬何種情況而定）。
 - 如發展項目屬地政總署預售樓花同意方案所規管，賣方須在合格證明書或地政總署署長的轉讓同意發出後的一個月內（以較早者為準），就賣方有能力有效地轉讓有關物業一事，以書面通知買家；或
 - 如發展項目並非屬地政總署預售樓花同意方案所規管，賣方須在佔用文件（包括佔用許可證）發出後的六個月內，就賣方有能力有效地轉讓有關物業一事，以書面通知買家。
 - 條例規定買賣合約須載有強制性條文，列明有關物業的買賣須於賣方發出上述通知的日期的14日內完成。有關物業的買賣完成後，賣方將安排買家收樓事宜。
- 認可人士可批予在預計關鍵日期之後完成發展項目
 - 條例規定買賣合約須載有強制性條文，列明發展項目的認可人士可以在顧及純粹由以下一個或多於一個原因所導致的延遲後，批予在預計關鍵日期之後，完成發展項目：
 - 工人罷工或封閉工地；
 - 暴動或內亂；
 - 不可抗力或天災；
 - 火警或其他賣方所不能控制的意外；
 - 戰爭；或
 - 惡劣天氣。
 - 發展項目的認可人士可以按情況，多於一次批予延後預計關鍵日期以完成發展項目，即收樓日期可能延遲。
 - 條例規定買賣合約須載有強制性條文，列明賣方須於認可人士批予延期後的14日內，向買家提供有關延期證明書的文本。
- 如對收樓日期有任何疑問，可向賣方查詢。

適用於一手已落成住宅物業

16. 賣方資料表格

- 確保取得最近三個月內印製有關您擬購買的一手已落成住宅物業的「賣方資料表格」。

17. 參觀物業

- 購置住宅物業前，確保已獲安排參觀您打算購置的住宅物業。倘參觀有關物業並非合理地切實可行，則應參觀與有關物業相若的物業，除非您以書面同意賣方無須開放與有關物業相若的物業供您參觀。您應仔細考慮，然後才決定是否簽署豁免上述規定的書面同意。
- 除非有關物業根據租約持有，或為確保物業參觀者的人身安全而須設定合理限制，您可以對該物業進行量度、拍照或拍攝影片。

任何與賣方銷售受條例所規管的一手住宅物業有關的投訴和查詢，請與一手住宅物業銷售監管局聯絡。

網址：www.srpa.gov.hk
電話：2817 3313
電郵：enquiry_srpa@hd.gov.hk
傳真：2219 2220

其他相關聯絡資料：

消費者委員會 網址： www.consumer.org.hk 電話：2929 2222 電郵： cc@consumer.org.hk 傳真：2856 3611	地產代理監管局 網址： www.eaa.org.hk 電話：2111 2777 電郵： enquiry@eaa.org.hk 傳真：2598 9596
---	--

香港地產建設商會 電話：2826 0111 傳真：2845 2521	運輸及房屋局 一手住宅物業銷售監管局 2021年7月
---	---

備註：

- 按揭貸款計劃的資料包括有關按揭貸款計劃對借款人的最低收入的要求、就第一按揭連同第二按揭可獲得的按揭貸款金額上限、最長還款年期、整個還款期內的按揭利率變化，以及申請人須繳付的手續費。
- 根據條例附表 1 第 1 部第 10(2)(d)條述明，售樓說明書內顯示的發展項目中的住宅物業的每一份樓面平面圖須述明以下各項—
 - 每個住宅物業的外部尺寸；
 - 每個住宅物業的內部尺寸；
 - 每個住宅物業的內部間隔的厚度；
 - 每個住宅物業內個別分隔室的外部尺寸。
 根據條例附表 1 第 1 部第 10(3)條，如有關發展項目的經批准的建築圖則，提供條例附表 1 第 1 部第 10(2)(d)條所規定的資料，樓面平面圖須述明如此規定的該資料。
- 一般而言，「關鍵日期」指該項目符合批地文件的條件的日期，或該項目在遵照經批准的建築圖則的情況下或按照豁免證明書的發出的條件在各方面均屬完成的日期。有關詳情請參閱條例第2條。

Name of the Development

The Arles

Name of the street at which the Development is situated and the street number

1 Au Pui Wan Street

(Note: this provisional street number is subject to confirmation when the Development is completed.)

Total number of storeys of each multi-unit building

Tower 1 : 39 storeys

Tower 2 : 39 storeys

Tower 3 : 41 storeys

Tower 5 : 41 storeys

The above number of storeys excludes basement floor (B/F), G/F, 1/F, 2/F, podium floor, transfer plate, refuge floor, roof and top roof.

Floor numbering in each multi-unit building as provided in the approved building plans

Tower 1 : 5/F-12/F, 15/F-23/F, 26/F-33/F, 35/F-43/F, 45/F-49/F

Tower 2 : 5/F-12/F, 15/F-23/F, 26/F-33/F, 35/F-43/F, 45/F-49/F

Tower 3 : 5/F-12/F, 15/F-23/F, 26/F-33/F, 35/F-43/F, 45/F-51/F

Tower 5 : 5/F-12/F, 15/F-23/F, 26/F-33/F, 35/F-43/F, 45/F-51/F

Omitted floor numbers in each multi-unit building in which the floor numbering is not in consecutive order

4/F, 13/F, 14/F, 24/F, 34/F and 44/F are omitted.

Refuge floor (if any) of each multi-unit building

25/F

The Development is an uncompleted development

Estimated material date for the Development as provided by the authorized person for the Development: 31 March 2023.

The estimated material date is subject to any extension of time that is permitted under the Agreement for Sale and Purchase. For the purpose of the Agreement for Sale and Purchase, without limiting any other means by which the completion of the Development may be proved, the issue of a certificate of compliance or consent to assign by the Director of Lands is conclusive evidence that the Development has been completed or is deemed to be completed (as the case may be).

發展項目名稱

星凱·堤岸

發展項目所位於的街道名稱及門牌號數

坳背灣街1號

(備註：此臨時門牌號數有待發展項目建成時確認。)

每幢多單位建築物的樓層總數

第1座：39層

第2座：39層

第3座：41層

第5座：41層

以上樓層數目不包括地庫樓層（地庫）、地下、1樓、2樓、基座平台、轉換層、庇護層、天台及上層天台。

經批准的建築圖則所規定的每幢多單位建築物內的樓層號數

第1座：5樓至12樓、15樓至23樓、26樓至33樓、35樓至43樓、45樓至49樓

第2座：5樓至12樓、15樓至23樓、26樓至33樓、35樓至43樓、45樓至49樓

第3座：5樓至12樓、15樓至23樓、26樓至33樓、35樓至43樓、45樓至51樓

第5座：5樓至12樓、15樓至23樓、26樓至33樓、35樓至43樓、45樓至51樓

每幢有不依連續次序的樓層號數的多單位建築物內被略去的樓層號數

不設4樓、13樓、14樓、24樓、34樓及44樓。

每幢多單位建築物內的庇護層（如有的話）

25樓

發展項目屬未落成發展項目

由發展項目的認可人士提供的發展項目的預計關鍵日期：2023年3月31日。

預計關鍵日期是受到買賣合約所允許的任何延期所規限的。為買賣合約的目的，在不局限任何其他可用以證明該項目落成的方法的原則下，地政總署署長發出的合格證明書或轉讓同意，即為發展項目已落成或當作已落成（視屬何情況而定）的確證。

Vendor

Centralcon (Fo Tan) Company Limited

Holding Companies of the Vendor

Centralcon Properties Company Limited
Angel River Holdings Limited
Ever Reality Limited

Authorized Person for the Development

Mr. Wong Ming-Yim of DLN Architects Limited
(Mr. Wong Ming-Yim is a director of DLN Architects Limited)

Building Contractor for the Development

China Overseas Building Construction Limited

The firm of solicitors acting for the owner in relation to the sale of residential properties in the Development

Lo & Lo
Lu Lai & Li
Zhong Lun Law Firm LLP

Authorized institution that has made a loan, or has undertaken to provide finance, for the construction of the Development

China Construction Bank (Asia) Corporation Limited
China Minsheng Banking Corp., Ltd. Hong Kong Branch
Chiyu Banking Corporation Limited
CMB Wing Lung Bank Limited
Chong Hing Bank Limited
Dah Sing Bank, Limited
Hang Seng Bank Limited
Industrial and Commercial Bank of China (Asia) Limited
Nanyang Commercial Bank, Limited
The Bank of East Asia, Limited

Other person who has made a loan for the construction of the Development

Centralcon Properties Company Limited

賣方

中洲（火炭）有限公司

賣方的控權公司

中洲置業有限公司
Angel River Holdings Limited
Ever Reality Limited

發展項目的認可人士

劉榮廣伍振民建築師有限公司的王明炎先生
(王明炎先生為劉榮廣伍振民建築師有限公司的董事)

發展項目的承建商

中國海外房屋工程有限公司

就發展項目中的住宅物業的出售而代表擁有人行事的律師事務所的名稱

羅文錦律師樓
姚黎李律師行
中倫律師事務所有限法律責任合夥

已為發展項目的建造提供貸款或已承諾為該項建造提供融資的認可機構

中國建設銀行（亞洲）股份有限公司
中國民生銀行股份有限公司香港分行
集友銀行有限公司
招商永隆銀行有限公司
創興銀行有限公司
大新銀行有限公司
恒生銀行有限公司
中國工商銀行（亞洲）有限公司
南洋商業銀行有限公司
東亞銀行有限公司

已為發展項目的建造提供貸款的其他人

中洲置業有限公司

(a) The vendor or a building contractor for the Development is an individual, and that vendor or contractor is an immediate family member of an authorized person for the Development. 賣方或有關發展項目的承建商屬個人，並屬該發展項目的認可人士的家人。	Not Applicable 不適用
(b) The vendor or a building contractor for the Development is a partnership, and a partner of that vendor or contractor is an immediate family member of such an authorized person. 賣方或該發展項目的承建商屬合夥，而該賣方或承建商的合夥人屬上述認可人士的家人。	Not Applicable 不適用
(c) The vendor or a building contractor for the Development is a corporation, and a director or the secretary of that vendor or contractor (or a holding company of that vendor) is an immediate family member of such an authorized person. 賣方或該發展項目的承建商屬法團，而該賣方或承建商（或該賣方的控權公司）的董事或秘書屬上述認可人士的家人。	NO 否
(d) The vendor or a building contractor for the Development is an individual, and that vendor or contractor is an immediate family member of an associate of such an authorized person. 賣方或該發展項目的承建商屬個人，並屬上述認可人士的有聯繫人士的家人。	Not Applicable 不適用
(e) The vendor or a building contractor for the Development is a partnership, and a partner of that vendor or contractor is an immediate family member of an associate of such an authorized person. 賣方或該發展項目的承建商屬合夥，而該賣方或承建商的合夥人屬上述認可人士的有聯繫人士的家人。	Not Applicable 不適用
(f) The vendor or a building contractor for the Development is a corporation, and a director or the secretary of that vendor or contractor (or a holding company of that vendor) is an immediate family member of an associate of such an authorized person. 賣方或該發展項目的承建商屬法團，而該賣方或承建商（或該賣方的控權公司）的董事或秘書屬上述認可人士的有聯繫人士的家人。	NO 否
(g) The vendor or a building contractor for the Development is an individual, and that vendor or contractor is an immediate family member of a proprietor of a firm of solicitors acting for the owner in relation to the sale of residential properties in the Development. 賣方或該發展項目的承建商屬個人，並屬就該發展項目內的住宅物業的出售代表擁有人行事的律師事務所行事的經營人的家人。	Not Applicable 不適用
(h) The vendor or a building contractor for the Development is a partnership, and a partner of that vendor or contractor is an immediate family member of a proprietor of a firm of solicitors acting for the owner in relation to the sale of residential properties in the Development. 賣方或該發展項目的承建商屬合夥，而該賣方或承建商的合夥人屬就該發展項目內的住宅物業的出售代表擁有人行事的律師事務所行事的經營人的家人。	Not Applicable 不適用
(i) The vendor or a building contractor for the Development is a corporation, and a director or the secretary of that vendor or contractor (or a holding company of that vendor) is an immediate family member of a proprietor of such a firm of solicitors. 賣方或該發展項目的承建商屬法團，而該賣方或承建商（或該賣方的控權公司）的董事或秘書屬上述律師事務所的經營人的家人。	NO 否

(j) The vendor, a holding company of the vendor, or a building contractor for the Development, is a private company, and an authorized person for the Development, or an associate of such an authorized person, holds at least 10% of the issued shares in that vendor, holding company or contractor. 賣方、賣方的控權公司或有關發展項目的承建商屬私人公司，而該發展項目的認可人士或該認可人士的有聯繫人士持有該賣方、控權公司或承建商最少10%的已發行股份。	NO 否
(k) The vendor, a holding company of the vendor, or a building contractor for the Development, is a listed company, and such an authorized person, or such an associate, holds at least 1% of the issued shares in that vendor, holding company or contractor. 賣方、賣方的控權公司或該發展項目的承建商屬上市公司，而上述認可人士或上述有聯繫人士持有該賣方、控權公司或承建商最少1%的已發行股份。	Not Applicable 不適用
(l) The vendor or a building contractor for the Development is a corporation, and such an authorized person, or such an associate, is an employee, director or secretary of that vendor or contractor or of a holding company of that vendor. 賣方或該發展項目的承建商屬法團，而上述認可人士或上述有聯繫人士屬該賣方、承建商或該賣方的控權公司的僱員、董事或秘書。	NO 否
(m) The vendor or a building contractor for the Development is a partnership, and such an authorized person, or such an associate, is an employee of that vendor or contractor. 賣方或該發展項目的承建商屬合夥，而上述認可人士或上述有聯繫人士屬該賣方或承建商的僱員。	Not Applicable 不適用
(n) The vendor, a holding company of the vendor, or a building contractor for the Development, is a private company, and a proprietor of a firm of solicitors acting for the owner in relation to the sale of residential properties in the Development holds at least 10% of the issued shares in that vendor, holding company or contractor. 賣方、賣方的控權公司或該發展項目的承建商屬私人公司，而就該發展項目中的住宅物業的出售而代表擁有人行事的律師事務所的經營人持有該賣方、控權公司或承建商最少10%的已發行股份。	NO 否
(o) The vendor, a holding company of the vendor, or a building contractor for the Development, is a listed company, and a proprietor of such a firm of solicitors holds at least 1% of the issued shares in that vendor, holding company or contractor. 賣方、賣方的控權公司或該發展項目的承建商屬上市公司，而上述律師事務所的經營人持有該賣方、控權公司或承建商最少1%的已發行股份。	Not Applicable 不適用
(p) The vendor or a building contractor for the Development is a corporation, and a proprietor of such a firm of solicitors is an employee, director or secretary of that vendor or contractor or of a holding company of that vendor. 賣方或該發展項目的承建商屬法團，而上述律師事務所的經營人屬該賣方或承建商或該賣方的控權公司的僱員、董事或秘書。	NO 否
(q) The vendor or a building contractor for the Development is a partnership, and a proprietor of such a firm of solicitors is an employee of that vendor or contractor. 賣方或該發展項目的承建商屬合夥，而上述律師事務所的經營人屬該賣方或承建商的僱員。	Not Applicable 不適用

<p>(r) The vendor or a building contractor for the Development is a corporation, and the corporation of which an authorized person for the Development is a director or employee in his or her professional capacity is an associate corporation of that vendor or contractor or of a holding company of that vendor. 賣方或該發展項目的承建商屬法團，而該發展項目的認可人士以其專業身分擔任董事或僱員的法團為該賣方或承建商或該賣方的控股公司的有聯繫法團。</p>	<p>NO 否</p>
<p>(s) The vendor or a building contractor for the Development is a corporation, and that contractor is an associate corporation of that vendor or of a holding company of that vendor. 賣方或該發展項目的承建商屬法團，而該承建商屬該賣方或該賣方的控股公司的有聯繫法團。</p>	<p>NO 否</p>

There will be non-structural prefabricated external walls forming part of the enclosing walls of the Development.
發展項目將有非結構的預製外牆構成圍封牆的一部份。

THICKNESS OF THE NON-STRUCTURAL PREFABRICATED EXTERNAL WALLS OF EACH BLOCK:

每幢建築物的非結構的預製外牆的厚度：

Thickness of the Non-Structural Prefabricated External Walls (mm) 非結構的預製外牆的厚度 (毫米)
150mm 150毫米

Tower 座	Floor 樓層	Unit 單位	Total Area of the non-structural prefabricated external walls of each residential property (sq.m) 每個住宅物業的非結構的預裝外牆總面積 (平方米)
Tower 1 第1座	5/F - 48/F (omitted 13/F, 14/F, 24/F, 34/F & 44/F) 5樓 - 48樓 (不設13樓, 14樓, 24樓, 34樓及44樓)	A	0.881
		B	0.000
		C	0.000
		D	0.000
		E	0.383
		F	0.000
		G	0.439
		H	0.401
	49/F 49樓	A	0.390
		B	0.000
		C	0.248

Tower 座	Floor 樓層	Unit 單位	Total Area of the non-structural prefabricated external walls of each residential property (sq.m) 每個住宅物業的非結構的預裝外牆總面積 (平方米)
Tower 2 第2座	5/F - 48/F (omitted 13/F, 14/F, 24/F, 34/F & 44/F) 5樓 - 48樓 (不設13樓, 14樓, 24樓, 34樓及44樓)	A	0.000
		B	0.199
		C	0.891
		D	1.165
		E	0.626
		F	0.836
		G	0.994
		H	0.000
	49/F 49樓	A	0.625
		B	1.174

Note: 13/F, 14/F, 24/F, 34/F and 44/F are omitted. 25/F is refuge floor.

備註：不設13樓、14樓、24樓、34樓及44樓。25樓為庇護層。

Tower 座	Floor 樓層	Unit 單位	Total Area of the non-structural prefabricated external walls of each residential property (sq.m) 每個住宅物業的非結構的預裝外牆總面積 (平方米)
Tower 3 第3座	5/F - 49/F (omitted 13/F, 14/F, 24/F, 34/F & 44/F) 5樓 - 49樓 (不設13樓, 14樓, 24樓, 34樓及44樓)	A	0.754
		B	0.475
		C	1.287
		D	0.522
		E	0.000
		F	0.000
		G	0.000
		H	0.537
		J	0.521
		50/F 50樓	C
	D		0.000
	E		0.537
	F		0.521
	51/F 51樓	C	0.522
		D	0.000
		E	0.537
		F	0.521
	50/F & 51/F 50樓及51樓	A (Duplex Unit 複式單位)	2.218
B (Duplex Unit 複式單位)		1.227	

Tower 座	Floor 樓層	Unit 單位	Total Area of the non-structural prefabricated external walls of each residential property (sq.m) 每個住宅物業的非結構的預裝外牆總面積 (平方米)
Tower 5 第5座	5/F 5樓	A	0.754
		B	0.475
		C	1.118
		D	0.522
		E	0.000
		F	0.000
		G	0.000
		H	0.567
		J	0.506
		6/F - 49/F (omitted 13/F, 14/F, 24/F, 34/F & 44/F) 6樓 - 49樓 (不設13樓, 14樓, 24樓, 34樓及44樓)	A
	B		0.475
	C		1.264
	D		0.522
	E		0.000
	F		0.000
	G		0.000
	H		0.567
	J		0.506
	50/F 50樓		C
		D	0.000
		E	0.566
		F	0.506
	51/F 51樓	C	0.522
		D	0.000
		E	0.567
		F	0.506
	50/F & 51/F 50樓及51樓	A (Duplex Unit 複式單位)	2.204
		B (Duplex Unit 複式單位)	0.795

Note: 13/F, 14/F, 24/F, 34/F and 44/F are omitted. 25/F is refuge floor.

備註：不設13樓、14樓、24樓、34樓及44樓。25樓為庇護層。

There will be curtain walls forming part of the enclosing walls of the Development.
發展項目將有幕牆構成圍封牆的一部分。

THICKNESS OF THE CURTAIN WALLS OF EACH BUILDING:

每幢建築物的幕牆的厚度：

Thickness of the Curtain Walls (mm) 幕牆的厚度 (毫米)
200 mm 200 毫米

Tower 座	Floor 樓層	Unit 單位	Total Area of the curtain walls of each residential property (sq.m) 每個住宅物業的幕牆的總面積 (平方米)
Tower 1 第1座	5/F 5樓	A	2.162
		B	0.542
		C	0.315
		D	0.953
		E	1.109
		F	0.553
		G	0.974
		H	1.621
	6/F - 48/F (omitted 13/F, 14/F, 24/F, 34/F & 44/F) 6樓 - 48樓 (不設13樓, 14樓, 24樓, 34樓及44樓)	A	2.346
		B	0.542
		C	0.315
		D	0.953
		E	1.109
		F	0.553
		G	0.766
		H	1.621
	49/F 49樓	A	3.432
		B	2.573
		C	2.936

Tower 座	Floor 樓層	Unit 單位	Total Area of the curtain walls of each residential property (sq.m) 每個住宅物業的幕牆的總面積 (平方米)
Tower 2 第2座	5/F 5樓	A	0.315
		B	0.386
		C	2.425
		D	1.445
		E	0.303
		F	1.898
		G	1.049
		H	0.170
	6/F - 48/F (omitted 13/F, 14/F, 24/F, 34/F & 44/F) 6樓 - 48樓 (不設13樓, 14樓, 24樓, 34樓及44樓)	A	0.315
		B	0.386
		C	2.425
		D	1.445
		E	0.303
		F	2.230
		G	1.039
		H	0.170
	49/F 49樓	A	4.888
B		4.445	

Note: 13/F, 14/F, 24/F, 34/F and 44/F are omitted. 25/F is refuge floor.

備註：不設13樓、14樓、24樓、34樓及44樓。25樓為庇護層。

Tower 座	Floor 樓層	Unit 單位	Total Area of the curtain walls of each residential property (sq.m) 每個住宅物業的幕牆的總面積 (平方米)
Tower 3 第3座	5/F 5樓	A	2.143
		B	1.338
		C	1.187
		D	0.984
		E	0.404
		F	0.399
		G	0.410
		H	1.556
		J	0.784
	6/F - 49/F (omitted 13/F, 14/F, 24/F, 34/F & 44/F) 6樓 - 49樓 (不設13樓, 14樓, 24樓, 34樓及44樓)	A	2.143
		B	0.999
		C	1.187
		D	0.984
		E	0.404
		F	0.399
		G	0.410
		H	1.556
		J	0.684
	50/F 50樓	C	1.398
		D	0.399
		E	2.418
		F	0.684
	51/F 51樓	C	2.024
		D	0.399
		E	2.418
		F	0.684
50/F & 51/F 50樓及51樓	A (Duplex Unit 複式單位)	6.951	
	B (Duplex Unit 複式單位)	3.588	

Tower 座	Floor 樓層	Unit 單位	Total Area of the curtain walls of each residential property (sq.m) 每個住宅物業的幕牆的總面積 (平方米)
Tower 5 第5座	5/F 5樓	A	2.143
		B	1.448
		C	1.187
		D	0.984
		E	0.404
		F	0.398
		G	0.410
		H	0.954
		J	0.684
	6/F - 49/F (omitted 13/F, 14/F, 24/F, 34/F & 44/F) 6樓 - 49樓 (不設13樓, 14樓, 24樓, 34樓及44樓)	A	2.143
		B	1.448
		C	1.187
		D	0.984
		E	0.404
		F	0.398
		G	0.410
		H	0.954
		J	0.684
	50/F 50樓	C	0.914
		D	0.404
		E	2.829
		F	0.684
	51/F 51樓	C	0.914
		D	0.404
		E	2.829
		F	0.684
50/F & 51/F 50樓及51樓	A (Duplex Unit 複式單位)	6.629	
	B (Duplex Unit 複式單位)	3.588	

Note: 13/F, 14/F, 24/F, 34/F and 44/F are omitted. 25/F is refuge floor.

備註：不設13樓、14樓、24樓、34樓及44樓。25樓為庇護層。

The Manager appointed under the latest draft deed of mutual covenant is:
Jones Lang LaSalle Management Services Limited

根據公契的最新擬稿獲委任的管理人是：
仲量聯行物業管理有限公司

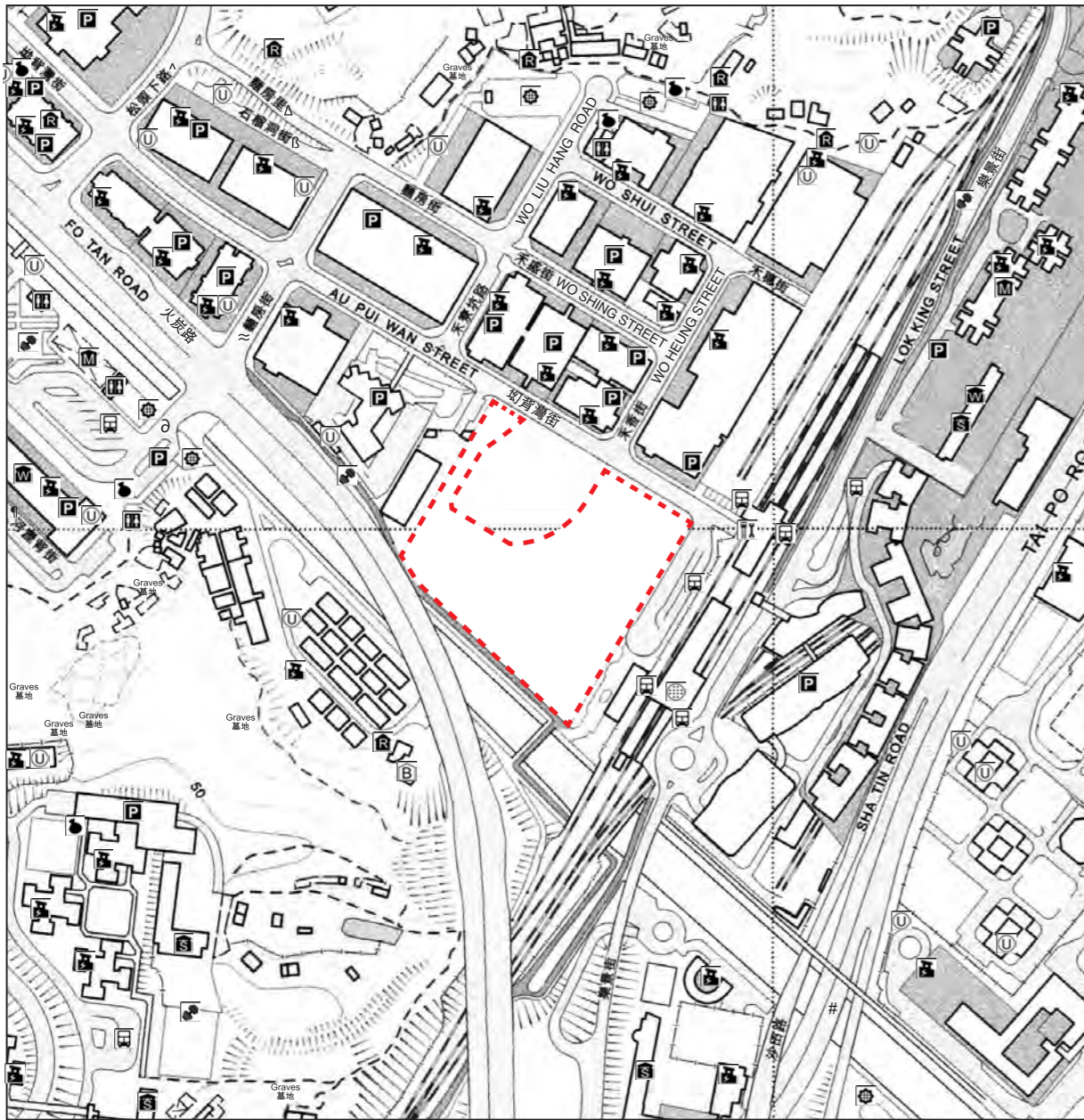

This Location Plan is prepared by the Vendor with reference to the Survey Sheet (Series HP5C), Sheet No. 7-SE-A dated 6 September 2021 from Survey and Mapping Office of the Lands Department, with adjustments where necessary.

此位置圖是參考日期為2021年9月6日之地政總署測繪處之測繪圖（組別編號HP5C），圖幅編號7-SE-A，並由賣方擬備，有需要處經修正處理。

NOTATION 圖例

- | | |
|---|---|
| Power Plant (including Electricity Sub-station)
發電廠（包括電力分站） | Columbarium
骨灰龕 |
| Public Utility Installation
分用事業設施裝置 | Religious Institution
(including Church, Temple and Tze Tong)
宗教場所（包括教堂、廟宇及祠堂） |
| Public Car Park (including Lorry Park)
公眾停車場（包括貨車停泊處） | Public Convenience
公廁 |
| Public Transport Terminal (including Rail Station)
公共交通總站（包括鐵路車站） | School (including Kindergarten)
學校（包括幼稚園） |
| Railway Depot
鐵路車廠 | Public Park
公園 |
| Ventilation Shaft for the Mass Transit Railway
香港鐵路通風井 | Refuse Collection Point
垃圾收集站 |
| Market (including Wet Market and Wholesale Market)
市場（包括濕貨市場及批發市場） | Social Welfare Facilities (including Elderly Centre and Home for the Mentally Disabled)
社會福利設施（包括老人中心及弱智人士護理院） |
| Sports Facilities
(including Sports Ground and Swimming Pool)
體育設施（包括運動場及游泳池） | |

The map reproduced with permission of the Director of Lands. © The Government of Hong Kong SAR Licence No. 39/2021.

地圖版權屬香港特別行政區政府，經地政總署准許複印，版權特許編號39/2021。

Notes:

- The Vendor advises prospective purchasers to conduct an on-site visit for a better understanding of the Development site, its surrounding environment and the public facilities nearby.
- The plan may show more than the area required under the Residential Properties (First-hand Sales) Ordinance due to technical reason that the boundary of the Development is irregular.

備註：

- 賣方建議準買家到發展項目地盤作實地考察，以對該發展項目地盤、其周邊地區環境及附近的公共設施有較佳了解。
- 由於發展項目的邊界不規則的技術原因，此圖所顯示的範圍可能超過《一手住宅物業銷售條例》所規定的範圍。

Location of the Development
發展項目的位置

Scale 0 250M/米
比例

Street name(s) not shown in full in the Location Plan of the Development:

於發展項目的所在位置圖未能顯示之街道全名：

Tai Po Road - Sha Tin 1 Ho Lek Pui Street ^ Tsung Tau Hai Road B Shek Lau Tung Street
大埔公路 - 沙田段 河瀝背街 松頭下路

Δ Min Fong Lane 9 Shan Mei Street * Min Fong Street
山尾街

This blank area
falls outside the
coverage of
the relevant
Aerial
Photograph
鳥瞰照片並不覆
蓋本空白範圍



Location of the Development
發展項目的位置

Adopted from part of the aerial photograph taken by the Survey and Mapping Office, Lands Department at a flying height of 6,900 feet, photo No. E104402C, date of flight: 24 November 2020.

摘錄自地政總署測繪處在6,900呎的飛行高度拍攝之鳥瞰照片，照片編號E104402C，飛行日期：2020年11月24日。

Survey and Mapping Office, Lands Department, The Government of Hong Kong SAR © Copyright reserved - reproduction by permission only.

香港特別行政區政府地政總署測繪處©版權所有，未經許可，不得複製。

Notes:

1. Copy of the aerial photograph of the Development is available for free inspection at the sales office during opening hours.
2. The aerial photograph may show more than the area required under the Residential Properties (First-hand Sales) Ordinance due to technical reason that the boundary of the Development is irregular.

備註：

1. 發展項目的鳥瞰照片之副本可於售樓處開放時間內免費查閱。
2. 由於發展項目的邊界不規則的技術原因，此照片所顯示的範圍可能超過《一手住宅物業銷售條例》所規定的範圍。



This blank area falls outside the coverage of the relevant Aerial Photograph
鳥瞰照片並不覆蓋本空白範圍

 Location of the Development
發展項目的位置

Adopted from part of the aerial photograph taken by the Survey and Mapping Office, Lands Department at a flying height of 6,900 feet, photo No. E104403C, date of flight: 24 November 2020.

摘錄自地政總署測繪處在6,900呎的飛行高度拍攝之鳥瞰照片，照片編號E104403C，飛行日期：2020年11月24日。

Survey and Mapping Office, Lands Department, The Government of Hong Kong SAR © Copyright reserved - reproduction by permission only.

香港特別行政區政府地政總署測繪處©版權所有，未經許可，不得複製。

Notes:

1. Copy of the aerial photograph of the Development is available for free inspection at the sales office during opening hours.
2. The aerial photograph may show more than the area required under the Residential Properties (First-hand Sales) Ordinance due to technical reason that the boundary of the Development is irregular.

備註：

1. 發展項目的鳥瞰照片之副本可於售樓處開放時間內免費查閱。
2. 由於發展項目的邊界不規則的技術原因，此照片所顯示的範圍可能超過《一手住宅物業銷售條例》所規定的範圍。



This blank area falls outside the coverage of the relevant Aerial Photograph
鳥瞰照片並不覆蓋本空白範圍

Location of the Development
發展項目的位置

Adopted from part of the aerial photograph taken by the Survey and Mapping Office, Lands Department at a flying height of 6,900 feet, photo No. E109758C, date of flight: 1 December 2020.

摘錄自地政總署測繪處在6,900呎的飛行高度拍攝之鳥瞰照片，照片編號E109758C，飛行日期：2020年12月1日。

Survey and Mapping Office, Lands Department, The Government of Hong Kong SAR © Copyright reserved - reproduction by permission only.

香港特別行政區政府地政總署測繪處©版權所有，未經許可，不得複製。

Notes:

1. Copy of the aerial photograph of the Development is available for free inspection at the sales office during opening hours.
2. The aerial photograph may show more than the area required under the Residential Properties (First-hand Sales) Ordinance due to technical reason that the boundary of the Development is irregular.

備註：

1. 發展項目的鳥瞰照片之副本可於售樓處開放時間內免費查閱。
2. 由於發展項目的邊界不規則的技術原因，此照片所顯示的範圍可能超過《一手住宅物業銷售條例》所規定的範圍。



Location of the Development
發展項目的位置

This blank area falls outside the coverage of
the relevant Aerial Photograph
鳥瞰照片並不覆蓋本空白範圍

Adopted from part of the aerial photograph taken by the Survey and Mapping Office, Lands Department at a flying height of 6,900 feet, photo No. E109759C, date of flight: 1 December 2020.

摘錄自地政總署測繪處在6,900呎的飛行高度拍攝之鳥瞰照片，照片編號E109759C，飛行日期：2020年12月1日。

Survey and Mapping Office, Lands Department, The Government of Hong Kong SAR © Copyright reserved - reproduction by permission only.

香港特別行政區政府地政總署測繪處©版權所有，未經許可，不得複製。

Notes:

1. Copy of the aerial photograph of the Development is available for free inspection at the sales office during opening hours.
2. The aerial photograph may show more than the area required under the Residential Properties (First-hand Sales) Ordinance due to technical reason that the boundary of the Development is irregular.

備註：

1. 發展項目的鳥瞰照片之副本可於售樓處開放時間內免費查閱。
2. 由於發展項目的邊界不規則的技術原因，此照片所顯示的範圍可能超過《一手住宅物業銷售條例》所規定的範圍。



Adopted from Part of the Approved Shatin Outline Zoning Plan, Plan No. S/ST/35, gazetted on 3rd December 2021, with adjustment where necessary as shown in red.

摘錄自2021年12月3日刊憲之沙田分區計劃大綱核准圖，圖則編號為S/ST/35，有需要處經修正處理，以紅色顯示。

NOTATION 圖例

ZONES

- COMMERCIAL
- COMPREHENSIVE DEVELOPMENT AREA
- COMMERCIAL/RESIDENTIAL
- RESIDENTIAL (GROUP A)
- RESIDENTIAL (GROUP B)
- RESIDENTIAL (GROUP C)
- VILLAGE TYPE DEVELOPMENT
- INDUSTRIAL
- GOVERNMENT, INSTITUTION OR COMMUNITY
- OPEN SPACE
- OTHER SPECIFIED USES
- GREEN BELT

Code	地帶
C	商業
CDA	綜合發展區
C/R	商業/住宅
R(A)	住宅 (甲類)
R(B)	住宅 (乙類)
R(C)	住宅 (丙類)
V	鄉村式發展
I	工業
G/C	政府、機構或社區
O	休憩用地
OU	其他指定用途
GB	綠化地帶

COMMUNICATIONS

- RAILWAY AND STATION
- RAILWAY AND STATION (UNDERGROUND)
- RAILWAY AND STATION (ELEVATED)
- MAJOR ROAD AND JUNCTION
- ELEVATED ROAD

Symbol	交通
[Railway Station Symbol]	鐵路及車站
[Underground Station Symbol]	鐵路及車站 (地下)
[Elevated Station Symbol]	鐵路及車站 (高架)
[Major Road Symbol]	主要道路及路口
[Elevated Road Symbol]	高架道路

MISCELLANEOUS

- BOUNDARY OF PLANNING SCHEME
- PLANNING AREA NUMBER
- BUILDING HEIGHT CONTROL ZONE BOUNDARY
- MAXIMUM BUILDING HEIGHT (IN METRES ABOVE PRINCIPAL DATUM)
- MAXIMUM BUILDING HEIGHT (IN NUMBER OF STOREYS)
- PETROL FILLING STATION

Symbol	其他
[Boundary Line Symbol]	規劃範圍界線
[Planning Area Number Symbol]	規劃區編號
[Height Control Boundary Symbol]	建築物高度管制區界線
[Height Symbol 160]	最高建築物高度 (在主水平基準上若干米)
[Height Symbol 3]	最高建築物高度 (樓層數目)
[Petrol Filling Station Symbol]	加油站

Location of the Development
 發展項目的位置



Notes:

- The last updated Outline Zoning Plan and the attached schedule as at the date of printing of the sales brochure are available for free inspection at the sales office during opening hours.
- The Vendor advises prospective purchasers to conduct an on-site visit for a better understanding of the Development site, its surrounding environment and the public facilities nearby.
- The plan may show more than the area required under the Residential Properties (First-hand Sales) Ordinance due to technical reason that the boundary of the Development is irregular.
- The plan, prepared by the Planning Department under the direction of the Town Planning Board, is reproduced with the permission of the Director of Lands. © The Government of Hong Kong SAR.

備註：

- 在印刷售樓說明書當日適用的最近期分區計劃大綱圖及其附表，可於售樓處開放時間內免費查閱。
- 賣方建議準買家到發展項目地盤作實地考察，以對該發展項目地盤、其周邊地區環境及附近的公共設施有較佳了解。
- 由於發展項目的邊界不規則的技術原因，此圖所顯示的範圍可能超過《一手住宅物業銷售條例》所規定的範圍。
- 此圖為規劃署遵照城市規劃委員會指示擬備，版權屬香港特別行政區政府，經地政總署准許複印。

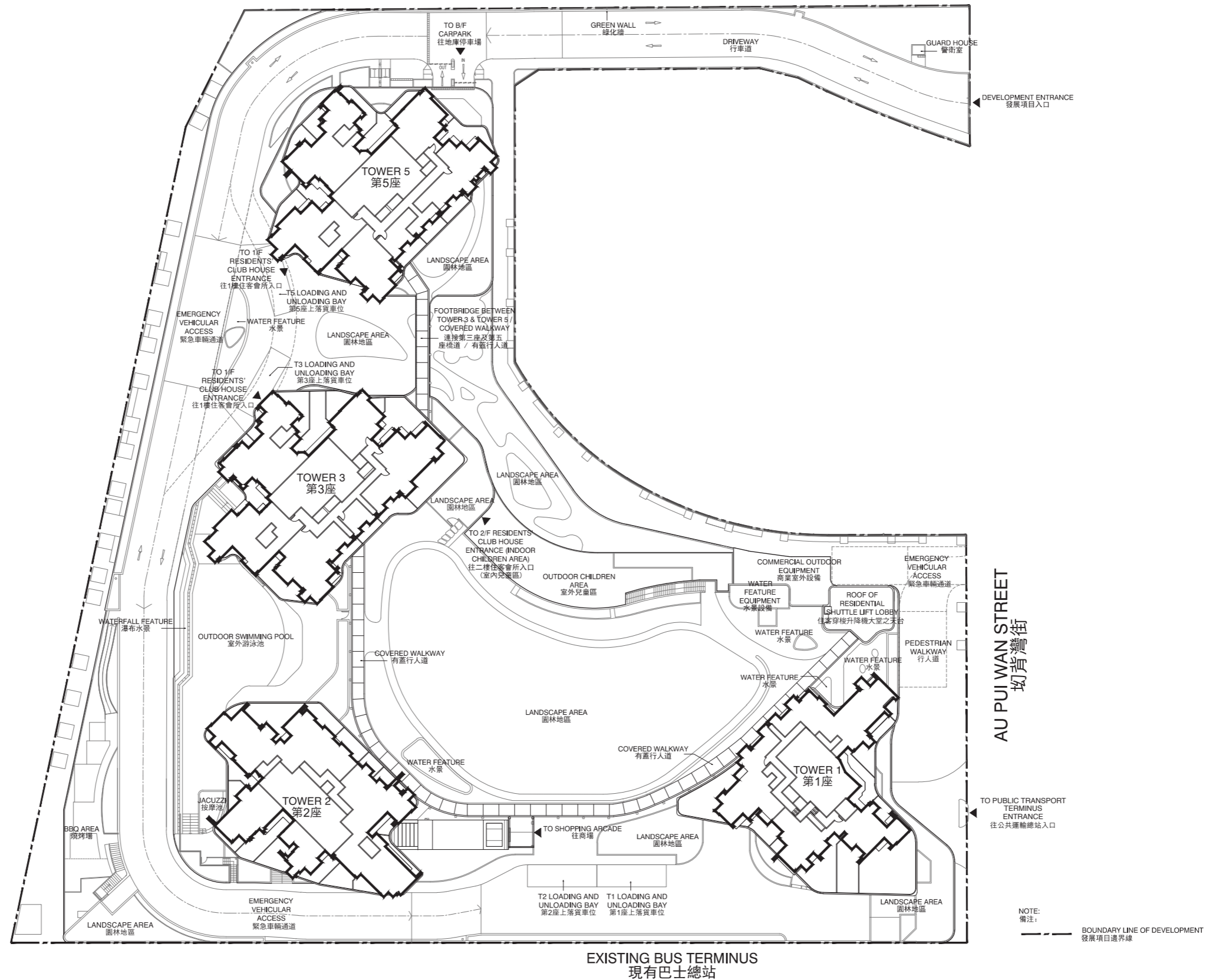

The estimated date of completion of the buildings and facilities in the Development, as provided by the Authorized Person for the Development is 30 September 2022

由發展項目的認可人士提供發展項目內的建築物及設施的預計落成日期為：2022年9月30日

Scale 0 25M/米
比例

The note and legends on this page apply to all pages of "Floor plans of residential properties in the Development".

在本頁上之備註和圖例適用於全部的「發展項目的住宅物業的樓面平面圖」的頁數。

Legend For Floor Plans 平面圖圖例

1.2M HIGH SOLID GLASS BALUSTRADE FOR NOISE MITIGATION = 1.2米高降音實心玻璃欄杆

1.5M HIGH SOLID GLASS BALUSTRADE = 1.5米高實心玻璃欄杆

ACCESS AND WORKING PLACE FOR DRAINAGE PIPE = 排水管道維修空間

A/C P. = Air-Conditioner Platform = 空調機平台

A/C PLINTH = Air-Conditioner Plinth = 空調機底座

A.D. = Air Duct = 風管槽

A.F. = Architectural Feature = 建築裝飾

BAL. = Balcony = 露台

BATH = Bathroom = 浴室

BATH 1 = Bathroom 1 = 浴室 1

BATH 2 = Bathroom 2 = 浴室 2

BATH 3 = Bathroom 3 = 浴室 3

BATH 4 = Bathroom 4 = 浴室 4

BED 1 = Bedroom 1 = 睡房 1

BED 2 = Bedroom 2 = 睡房 2

BED 3 = Bedroom 3 = 睡房 3

B.T.A.D. = Baffle Type Acoustic Door (With Fixed Glazing) = 擋音式減音門 (設有固定玻璃)

B.T.A.W. = Baffle Type Acoustic Window = 擋音式減音窗

BUILDING LINE ABOVE = 上層建築輪廓線

COMMON FLAT ROOF = 公用平台

DIN. = Dining Room = 飯廳

DN = Down = 落

DOG HOUSE (CONCRETE ENCLOSURE FOR COMMON DRAINAGE PIPE) = 喉管過路箱 (公共排水管道的混凝土圍封)

DOG HOUSE = DOG HOUSE (CONCRETE ENCLOSURE FOR COMMON DRAINAGE PIPE) 喉管過路箱 (公共排水管道的混凝土圍封)

DOG HOUSE# = DOG HOUSE (CONCRETE ENCLOSURE FOR E&M INSTALLATION SERVING THE UNIT)
喉管過路箱 (單位機電設備的混凝土圍封)

ELECT. METER ROOM = Electrical Meter Room = 電錶房

ELECT. ROOM = Electrical Room = 電掣房

ELECT. = Electrical Duct = 電線槽

ELV. = Extra-Low Voltage Duct = 特低壓電線槽

ELV. ROOM = Extra-low Voltage Room = 特低壓電力房

E.M.C. = Electrical Meter Cabinet = 電錶櫃

FAMILY ROOM = 家庭室

FAN ROOM (For R.S.M.R.R) = 風機房 (供垃圾及物料回收室)

---- Fixed Glazing (With Or Without Maintenance Window) = 固定窗戶 (設有或不設維修窗戶)

FLAT ROOF = 平台

FLUSHING WATER PUMP ROOM = 沖廁泵房

H.R. = Fire Hose Reel = 消防喉轆

JACUZZI = 按摩池

KIT. = Kitchen = 廚房

LAV. = Lavatory = 洗手間

LAV. 1 = Lavatory 1 = 洗手間 1

LAV. 2 = Lavatory 2 = 洗手間 2

LIFT = 升降機

LIFT LOBBY = 升降機大堂

LIFT OVERRUN = 升降機槽頂部

LIV. = Living Room = 客廳

M. BATH = Master Bathroom = 主人浴室

M. BED = Master Bedroom = 主人睡房

OPEN KIT. = Open Kitchen = 開放式廚房

OPEN WELL = 無遮天井

PANTRY = 備餐間

P.D. = Pipe Duct = 管道槽

PIPE WELL = 管道井

POTABLE WATER PUMP ROOM = 食水泵房

PRIVATE ROOF = 私人天台

PRIVATE ROOF FOR 48/F = 48樓私人天台

R.S.M.R.R. = Refuse Storage And Material Recovery Room = 垃圾及物料回收室

S.A. = Sound Absorption (Material At Ceiling) = 天花設有吸音物料

--- S.A.M. = Sound Absorption Material (Note 6) = 吸音物料 (備註6)

S.A.M. BAL. = Solid Parapet Balcony (With Sound Absorption Material At Ceiling) = 設有玻璃矮牆及吸音天花物料的露台

S.A.M. UP. = Utility Platform (With Sound Absorption Material At Ceiling) = 設有吸音天花物料的工作平台

SC.D. = Self-Closing Door = 自動閉合門

STO. = Store = 儲物室

STONE CLADDING BELOW = 石材飾板在下面

TOP OF STAIRHOOD = 梯屋上蓋

TOP SLAB OF BAL. = Top Slab of Balcony = 露台樓板上蓋

TOP SLAB OF U.P. = Top Slab of Utility Platform = 工作平台樓板上蓋

UP = Up = 上

U.P. = Utility Platform = 工作平台

UT. = Utility Room = 工作間

V.A.F = Vertical Acoustic Fin = 垂直隔音鱗

W.M.C. = Water Meter Cabinet = 水錶櫃

★ = -/30/30 Frr Wall = -/30/30隔火牆

Notes applicable to the floor plans of this section:

1. There may be architectural features and/or exposed common pipes on external walls of some floors. For details, please refer to the latest approved building plans.
2. There may be communal pipes and/or mechanical and electrical services within balconies, utility platforms, flat roofs and roofs of some residential units.
3. Some residential units have ceiling bulkheads and/or sunken slab at living room, bedrooms, bathrooms, utility rooms, store, internal staircase, corridor and kitchen for air-conditioning system and/or other mechanical and electrical services.
4. Symbols of fittings and fitments shown on the floor plans, such as bathtubs, sink, water closets, sink counter, etc. are architectural symbols retrieved from the latest approved general building plans and for general indication only.
5. Balconies and utility platforms and non-enclosed areas.
6. Location of sound absorption material for general indication only, the detailed extend is subject to EPD's comment and approval of NIA report.
7. Common pipes exposed or enclosed in cladding may be located at Balcony, Utility platform, Flat roof, Roof or external wall of some residential units.

適用於本節各樓面平面圖之備註：

1. 部分樓層外牆或設有建築裝飾及/或外露喉管。詳情請參考最新批准之建築圖則。
2. 部分住宅單位之露台、工作平台、平台及天台內或裝有公用喉管及/或機電設備。
3. 部分住宅單位的客廳、睡房、浴室、工作間、儲物房、室內樓梯、走廊及廚房之天花有假天花及/或跌級樓板，用以安裝空調及/或其他機電設備。
4. 平面圖上所顯示的形象裝置符號，例如浴缸、洗滌盆、坐廁、洗滌盆櫃等乃摘自最新的經批准的建築圖則，只作一般性標誌。
5. 露台和工作平台為不可封閉的地方。
6. 吸音物料的位置僅作示意用途，有關詳情請以環境保護署的意見及環境影響評估報告書之批核為準。
7. 部分住宅單位的露台、工作平台、天台或外牆或設有外露之公用喉管、或外牆裝飾板內藏之公用喉管。

TOWER 1
第1座

5/F
5樓

FLOOR PLAN
樓面平面圖

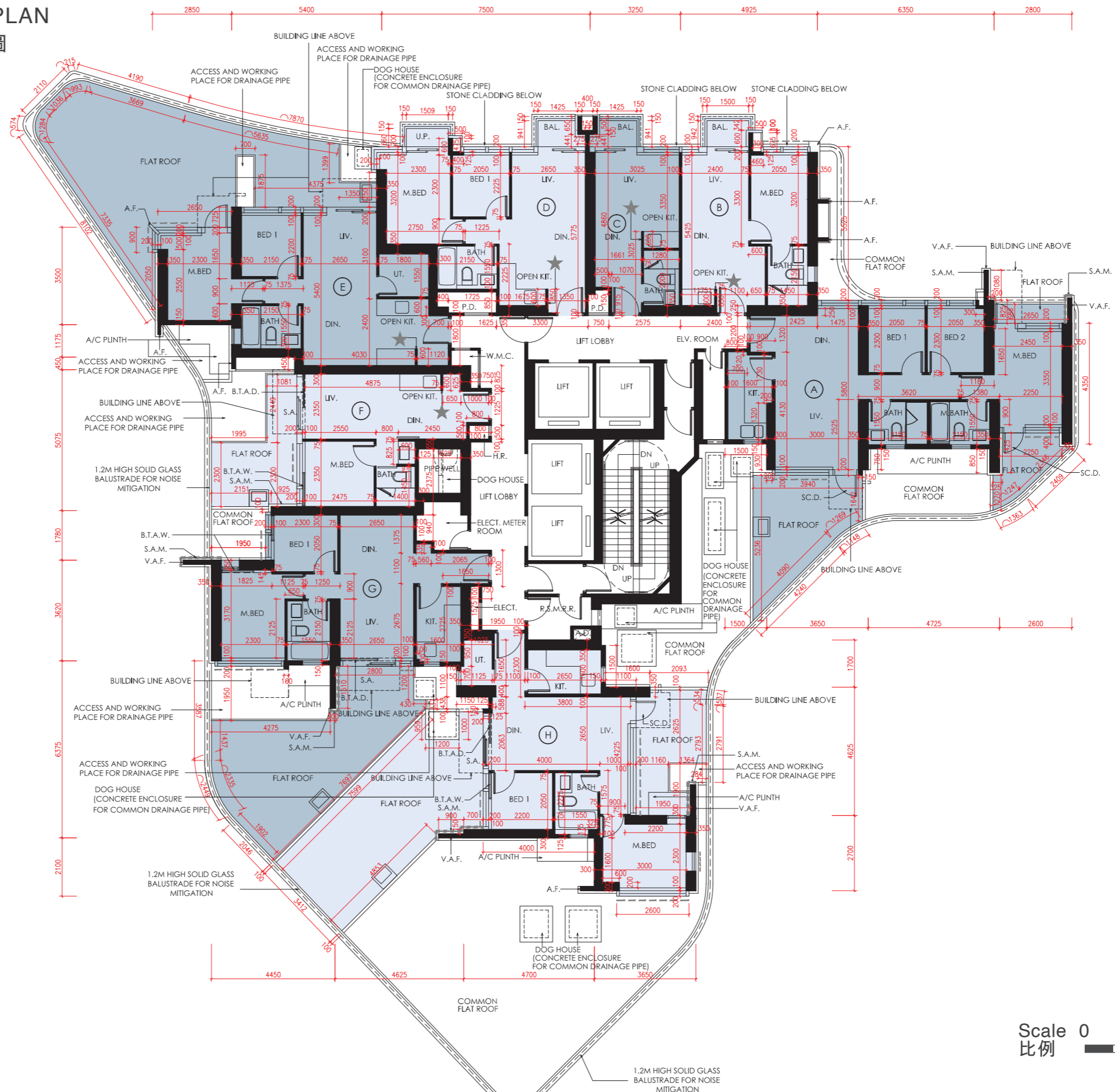

Scale 0
比例 5M/米

Description 描述	Tower 座	Floor 樓層	Unit 單位							
			A	B	C	D	E	F	G	H
The thickness of the floor slabs (excluding plaster) of each residential property (mm) 每個住宅物業的樓板（不包括灰泥）的厚度（毫米）	Tower 1 第1座	5/F 5樓	150, 175 & 300	150	150	150	150	150	150	150
The floor-to-floor height (refers to the height between the top surface of the structural slab of a floor and the top surface of the structural slab of its immediate upper floor) of each residential property (mm) 每個住宅物業的層與層之間的高度(指該樓層之石屎地台面與上一層石屎地台面之高度距離)（毫米）			2800, 3100, 3150 & 3575	2800 & 3150			2800, 3150 & 3575	2800, 3100, 3150 & 3575	2800, 3150 & 3575	

The internal areas of the residential properties on the upper floors will generally be slightly larger than those on the lower floors because of the reducing thickness of the structural walls on the upper floors.

因住宅物業的較高樓層的結構牆的厚度遞減，較高樓層的內部面積，一般比較低樓層的內部面積稍大。

Notes:

- The dimensions in the floor plans are all structural dimensions in millimetre and rounded off to the nearest integer.
- Please refer to Page 22-23 of this sales brochure for legend of the terms and abbreviations shown in the floor plan.
- Blank areas on the Flat roof are common areas that only the Manager shall have access in performance of its duty and exercise of its power.
- In relation to the Flat roofs of Units E, F, G & H of Tower 1, there are certain Residential Common Areas marked "Access and Working Place for Drainage Pipe" and "Concrete Enclosure for Common Drainage Pipe" which have to be accessed through certain Residential Units on the 5th Floor of the Tower.

備註：

- 樓面平面圖之尺規所列數字為以毫米標示之建築結構尺寸，並以四捨五入至整數。
- 平面圖中顯示之名詞及簡稱之圖例請參閱本售樓說明書第22-23頁。
- 平台空白位置只供管理人為履行其職責及行使權力而進入。
- 有關發展項目第1座5樓E、F、G及H單位平台存在某些住宅公用地方並以「排水管道維修空間」及「公共排水管道的混凝土圍封」標記，並且需經由某些於該座5樓住宅單位而進入。

TOWER 1
第1座

6/F - 12/F & 15/F - 23/F (13/F & 14/F ARE OMITTED)
6樓至12樓及15樓至23樓 (不設13樓及14樓)

FLOOR PLAN
樓面平面圖

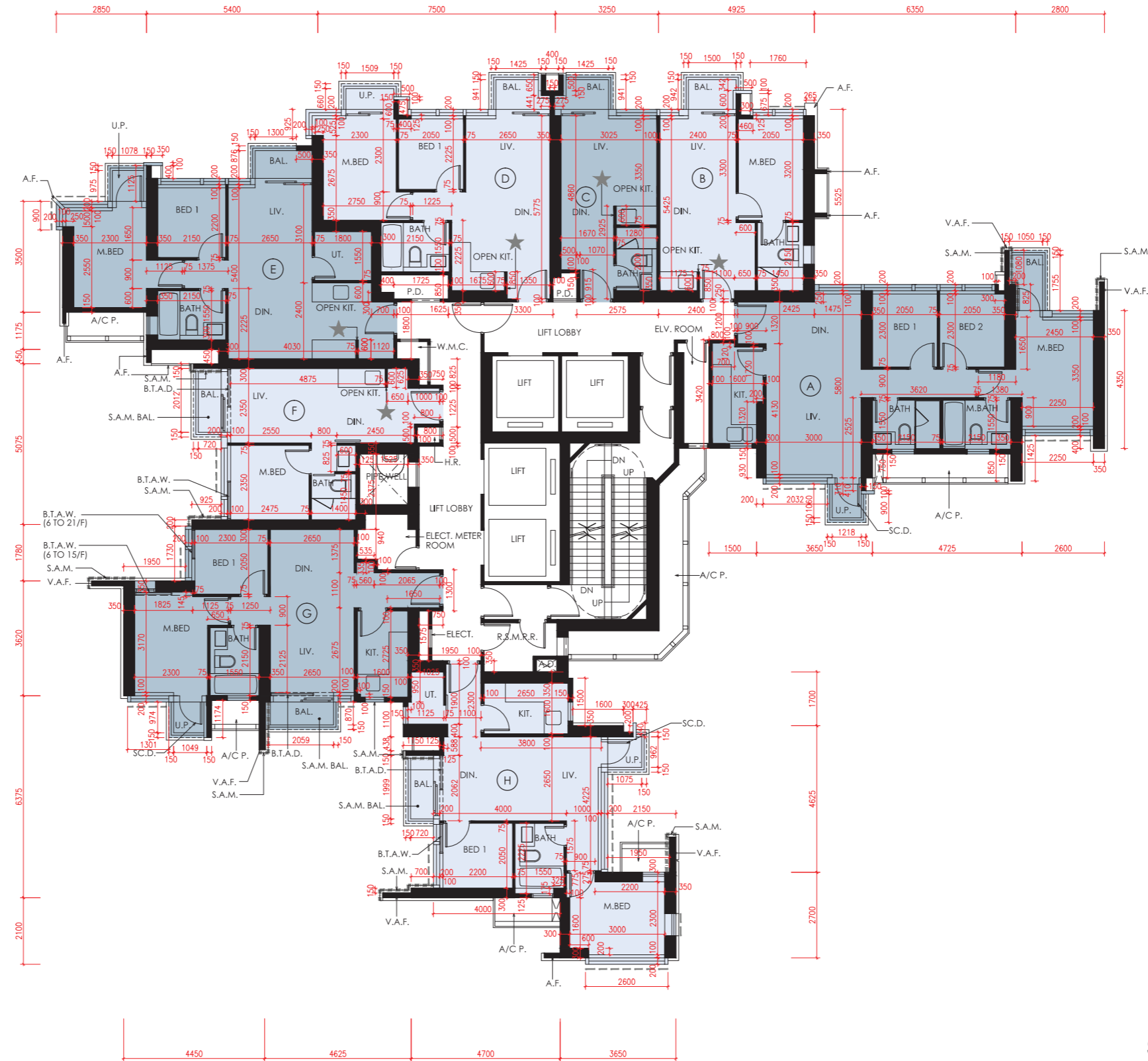

Scale 0 5M/米
比例

Description 描述	Tower 座	Floor 樓層	Unit 單位							
			A	B	C	D	E	F	G	H
The thickness of the floor slabs (excluding plaster) of each residential property (mm) 每個住宅物業的樓板（不包括灰泥）的厚度（毫米）	Tower 1 第1座	6/F - 12/F & 15/F - 22/F (13/F & 14/F are omitted) 6樓 - 12樓 及 15樓 - 22樓 (不設13樓及14樓)	150, 175 & 300	150	150	150	150	150	150	150
The floor-to-floor height (refers to the height between the top surface of the structural slab of a floor and the top surface of the structural slab of its immediate upper floor) of each residential property (mm) 每個住宅物業的層與層之間的高度(指該樓層之石屎地台面與上一層石屎地台面之高度距離)（毫米）			3150							
The thickness of the floor slabs (excluding plaster) of each residential property (mm) 每個住宅物業的樓板（不包括灰泥）的厚度（毫米）		150, 175 & 300	150							
The floor-to-floor height (refers to the height between the top surface of the structural slab of a floor and the top surface of the structural slab of its immediate upper floor) of each residential property (mm) 每個住宅物業的層與層之間的高度(指該樓層之石屎地台面與上一層石屎地台面之高度距離)（毫米）		23/F 23樓	3150, 3200 & 3500	3150 & 3500				3150, 3200 & 3500	3150 & 3500	

The internal areas of the residential properties on the upper floors will generally be slightly larger than those on the lower floors because of the reducing thickness of the structural walls on the upper floors.

因住宅物業的較高樓層的結構牆的厚度遞減，較高樓層的內部面積，一般比較低樓層的內部面積稍大。

- The dimensions in the floor plans are all structural dimensions in millimetre and rounded off to the nearest integer.
- Please refer to Page 22-23 of this sales brochure for legend of the terms and abbreviations shown in the floor plan.

- 樓面平面圖之尺規所列數字為以毫米標示之建築結構尺寸，並以四捨五入至整數。
- 平面圖中顯示之名詞及簡稱之圖例請參閱本售樓說明書第22-23頁。

TOWER 1
第1座

26/F
26樓

FLOOR PLAN
樓面平面圖

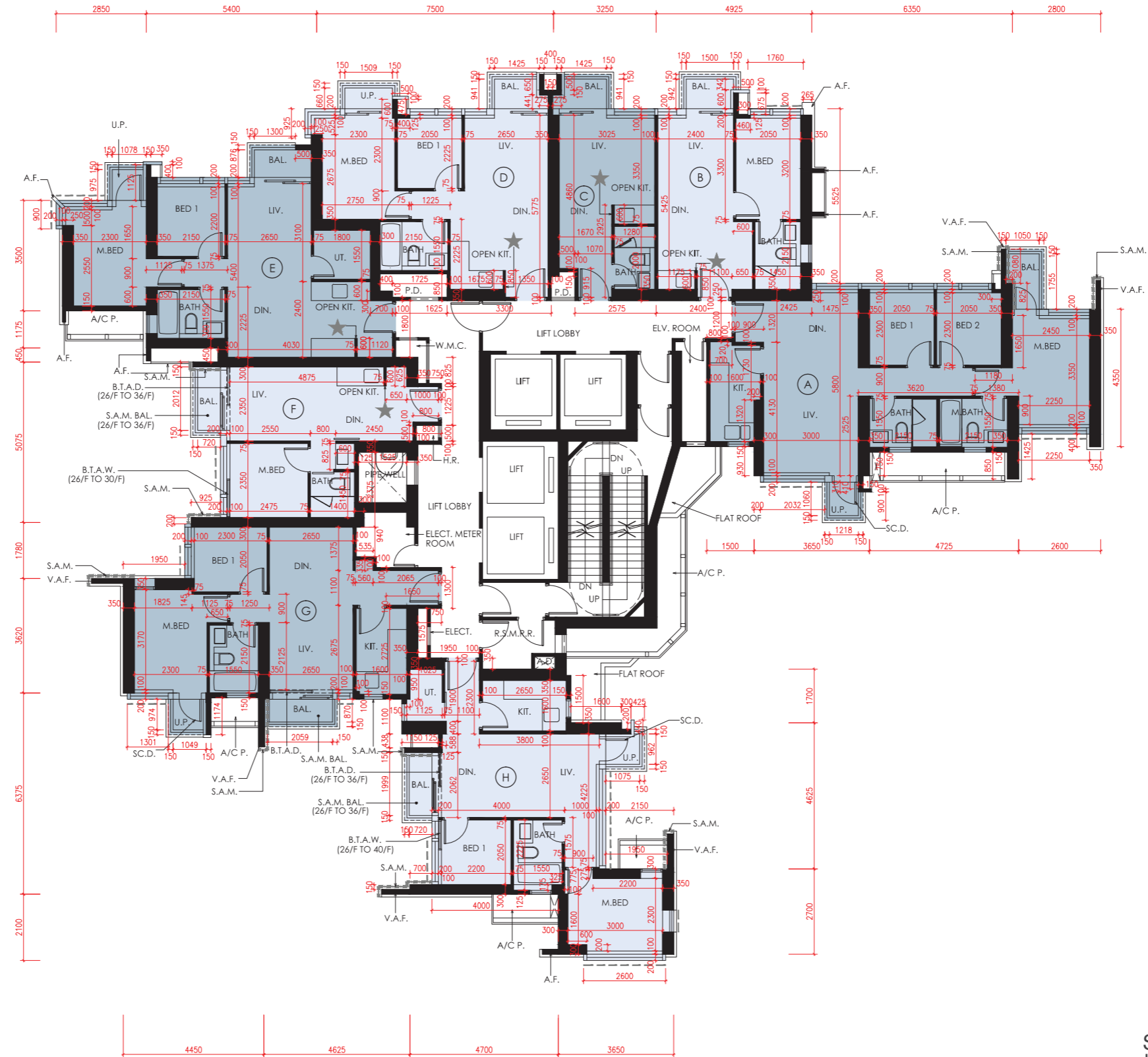

Scale 0 5M/米
比例

Description 描述	Tower 座	Floor 樓層	Unit 單位							
			A	B	C	D	E	F	G	H
The thickness of the floor slabs (excluding plaster) of each residential property (mm) 每個住宅物業的樓板（不包括灰泥）的厚度（毫米）	Tower 1 第1座	26/F 26樓	150, 175 & 300	150	150	150	150	150	150	150
The floor-to-floor height (refers to the height between the top surface of the structural slab of a floor and the top surface of the structural slab of its immediate upper floor) of each residential property (mm) 每個住宅物業的層與層之間的高度(指該樓層之石屎地台面與上一層石屎地台面之高度距離)（毫米）			3150							

The internal areas of the residential properties on the upper floors will generally be slightly larger than those on the lower floors because of the reducing thickness of the structural walls on the upper floors.

因住宅物業的較高樓層的結構牆的厚度遞減，較高樓層的內部面積，一般比較低樓層的內部面積稍大。

1. The dimensions in the floor plans are all structural dimensions in millimetre and rounded off to the nearest integer.
2. Please refer to Page 22-23 of this sales brochure for legend of the terms and abbreviations shown in the floor plan.

1. 樓面平面圖之尺規所列數字為以毫米標示之建築結構尺寸，並以四捨五入至整數。
2. 平面圖中顯示之名詞及簡稱之圖例請參閱本售樓說明書第22-23頁。

TOWER 1
第1座

27/F - 33/F, 35/F - 43/F & 45/F - 48/F (34/F & 44/F ARE OMITTED)
27樓至33樓、35樓至43樓及45樓至48樓 (不設34樓及44樓)

FLOOR PLAN
樓面平面圖

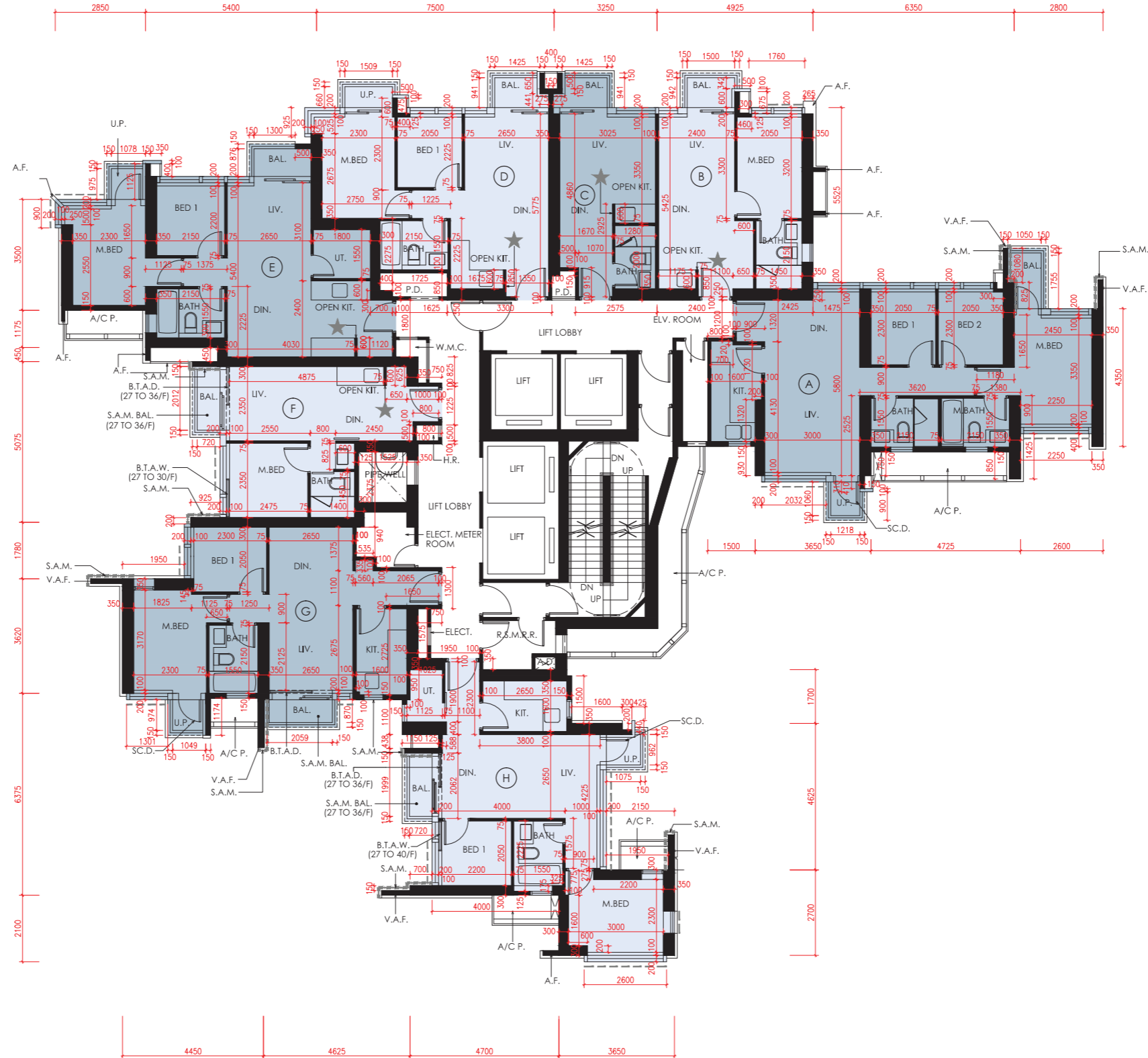

Scale 0 5M/米
比例

Description 描述	Tower 座	Floor 樓層	Unit 單位							
			A	B	C	D	E	F	G	H
The thickness of the floor slabs (excluding plaster) of each residential property (mm) 每個住宅物業的樓板（不包括灰泥）的厚度（毫米）	Tower 1 第1座	27/F - 33/F, 35/F - 43/F & 45/F - 47/F (34/F & 44/F are omitted) 27樓 - 33樓、35樓 - 43樓 及 45樓 - 47樓 (不設34樓及44樓)	150, 175 & 300	150	150	150	150	150	150	150
The floor-to-floor height (refers to the height between the top surface of the structural slab of a floor and the top surface of the structural slab of its immediate upper floor) of each residential property (mm) 每個住宅物業的層與層之間的高度(指該樓層之石屎地台面與上一層石屎地台面之高度距離)（毫米）			3150							
The thickness of the floor slabs (excluding plaster) of each residential property (mm) 每個住宅物業的樓板（不包括灰泥）的厚度（毫米）		48/F 48樓	150, 175 & 300	150	150	150 & 175	150	150	150	150
The floor-to-floor height (refers to the height between the top surface of the structural slab of a floor and the top surface of the structural slab of its immediate upper floor) of each residential property (mm) 每個住宅物業的層與層之間的高度(指該樓層之石屎地台面與上一層石屎地台面之高度距離)（毫米）			3150, 3200, 3500, 3550 & 3850	3150, 3500 & 3850		3200, 3500 & 3850	3150, 3200, 3500 & 3850	3050, 3150, 3400, 3500 & 3850	3150, 3200, 3500 & 3850	

The internal areas of the residential properties on the upper floors will generally be slightly larger than those on the lower floors because of the reducing thickness of the structural walls on the upper floors.

因住宅物業的較高樓層的結構牆的厚度遞減，較高樓層的內部面積，一般比較低樓層的內部面積稍大。

- The dimensions in the floor plans are all structural dimensions in millimetre and rounded off to the nearest integer.
- Please refer to Page 22-23 of this sales brochure for legend of the terms and abbreviations shown in the floor plan.

- 樓面平面圖之尺規所列數字為以毫米標示之建築結構尺寸，並以四捨五入至整數。
- 平面圖中顯示之名詞及簡稱之圖例請參閱本售樓說明書第22-23頁。

Description 描述	Tower 座	Floor 樓層	Unit 單位		
			A	B	C
The thickness of the floor slabs (excluding plaster) of each residential property (mm) 每個住宅物業的樓板（不包括灰泥）的厚度（毫米）	Tower 1 第1座	49/F 49樓	150 & 175	150, 200 & 600	150 & 200
The floor-to-floor height (refers to the height between the top surface of the structural slab of a floor and the top surface of the structural slab of its immediate upper floor) of each residential property (mm) 每個住宅物業的層與層之間的高度(指該樓層之石屎地台面與上一層石屎地台面之高度距離)（毫米）			3500, 3850 & 3900	3500, 3750, 3850, 3900, 3950 & 4250	

The internal areas of the residential properties on the upper floors will generally be slightly larger than those on the lower floors because of the reducing thickness of the structural walls on the upper floors.

因住宅物業的較高樓層的結構牆的厚度遞減，較高樓層的內部面積，一般比較低樓層的內部面積稍大。

1. The dimensions in the floor plans are all structural dimensions in millimetre and rounded off to the nearest integer.
2. Please refer to Page 22-23 of this sales brochure for legend of the terms and abbreviations shown in the floor plan.

1. 樓面平面圖之尺規所列數字為以毫米標示之建築結構尺寸，並以四捨五入至整數。
2. 平面圖中顯示之名詞及簡稱之圖例請參閱本售樓說明書第22-23頁。

TOWER 1
第1座

ROOF FLOOR PLAN
天台平面圖

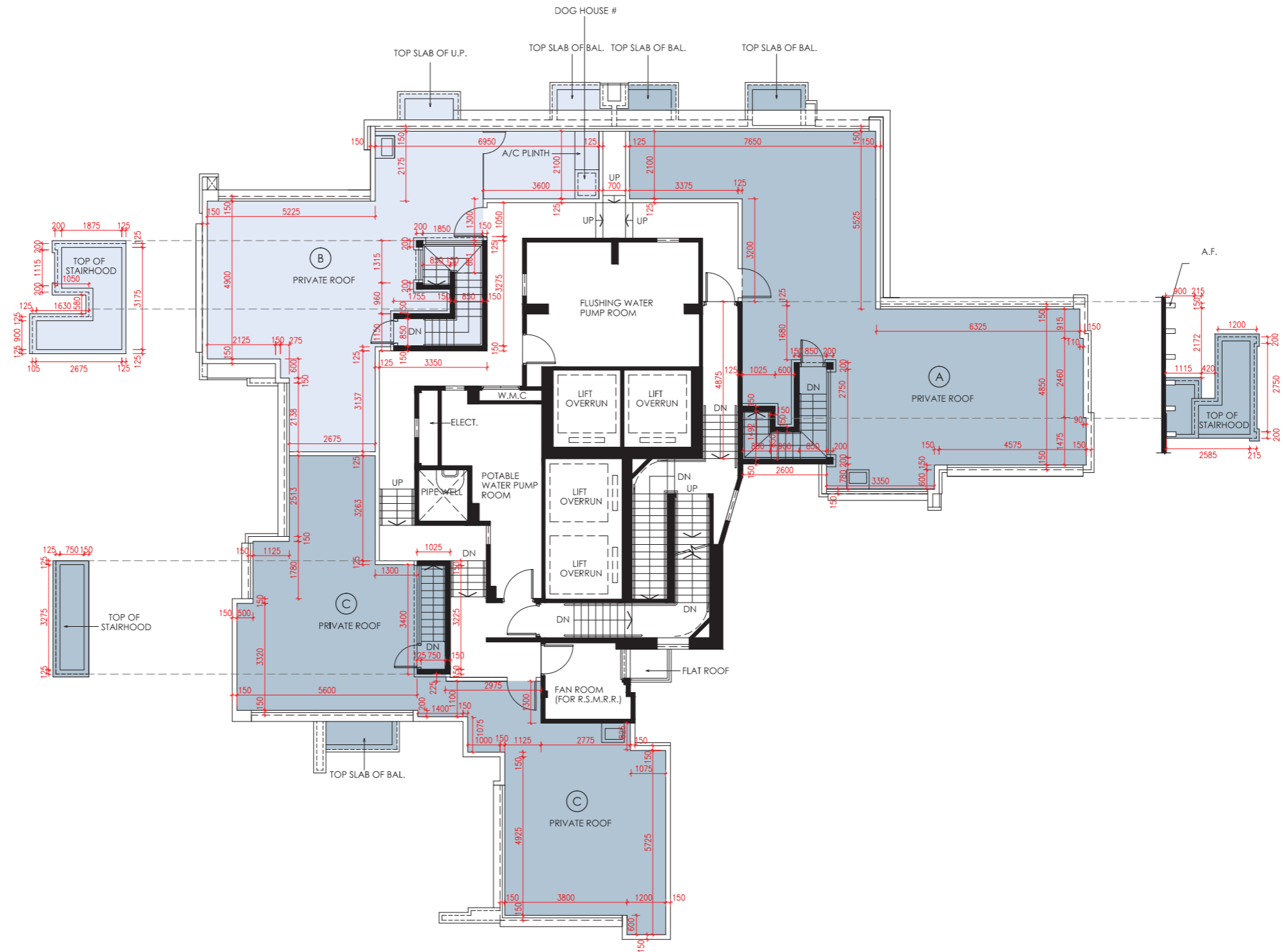

Scale 0 5M/米
比例

Description 描述	Tower 座	Floor 樓層	Unit 單位		
			A	B	C
The thickness of the floor slabs (excluding plaster) of each residential property (mm) 每個住宅物業的樓板（不包括灰泥）的厚度（毫米）	Tower 1 第1座	Roof 天台	150		
The floor-to-floor height (refers to the height between the top surface of the structural slab of a floor and the top surface of the structural slab of its immediate upper floor) of each residential property (mm) 每個住宅物業的層與層之間的高度(指該樓層之石屎地台面與上一層石屎地台面之高度距離)（毫米）			2700		

The internal areas of the residential properties on the upper floors will generally be slightly larger than those on the lower floors because of the reducing thickness of the structural walls on the upper floors.

因住宅物業的較高樓層的結構牆的厚度遞減，較高樓層的內部面積，一般比較低樓層的內部面積稍大。

1. The dimensions in the floor plans are all structural dimensions in millimetre and rounded off to the nearest integer.
2. Please refer to Page 22-23 of this sales brochure for legend of the terms and abbreviations shown in the floor plan.

1. 樓面平面圖之尺規所列數字為以毫米標示之建築結構尺寸，並以四捨五入至整數。
2. 平面圖中顯示之名詞及簡稱之圖例請參閱本售樓說明書第22-23頁。

Description 描述	Tower 座	Floor 樓層	Unit 單位							
			A	B	C	D	E	F	G	H
The thickness of the floor slabs (excluding plaster) of each residential property (mm) 每個住宅物業的樓板（不包括灰泥）的厚度（毫米）	Tower 2 第2座	5/F 5樓	150	150 & 175	150			150 & 175		150
The floor-to-floor height (refers to the height between the top surface of the structural slab of a floor and the top surface of the structural slab of its immediate upper floor) of each residential property (mm) 每個住宅物業的層與層之間的高度（指該樓層之石屎地台面與上一層石屎地台面之高度距離）（毫米）			2800, 3100, 3150 & 3575	2800, 3150 & 3575	2800, 3100, 3150 & 3575	2800, 3150 & 3575			2800, 3100, 3150 & 3575	2800, 3150 & 3575

The internal areas of the residential properties on the upper floors will generally be slightly larger than those on the lower floors because of the reducing thickness of the structural walls on the upper floors.

因住宅物業的較高樓層的結構牆的厚度遞減，較高樓層的內部面積，一般比較低樓層的內部面積稍大。

Notes:

- The dimensions in the floor plans are all structural dimensions in millimetre and rounded off to the nearest integer.
- Please refer to Page 22-23 of this sales brochure for legend of the terms and abbreviations shown in the floor plan.
- Blank areas on the Flat roof are common areas that only the Manager shall have access in performance of its duty and exercise of its power.
- In relation to the Flat roofs of Units A, B, C, D, E, F, G & H of Tower 2, there are certain Residential Common Areas marked "Access and Working Place for Drainage Pipe" and "Concrete Enclosure for Common Drainage Pipe" which have to be accessed through certain Residential Units on the 5th Floor of the Tower.

備註：

- 樓面平面圖之尺規所列數字為以毫米標示之建築結構尺寸，並以四捨五入至整數。
- 平面圖中顯示之名詞及簡稱之圖例請參閱本售樓說明書第22-23頁。
- 平台空白位置只供管理人為履行其職責及行使權力而進入。
- 有關發展項目第2座5樓A、B、C、D、E、F、G及H單位平台存在某些住宅公用地方並以「排水管道維修空間」及「公共排水管道的混凝土圍封」標記，並且需經由某些於該座5樓住宅單位而進入。

TOWER 2
第2座

6/F - 12/F & 15/F - 23/F (13/F & 14/F ARE OMITTED)
6樓至12樓及15樓至23樓 (不設13樓及14樓)

FLOOR PLAN
樓面平面圖

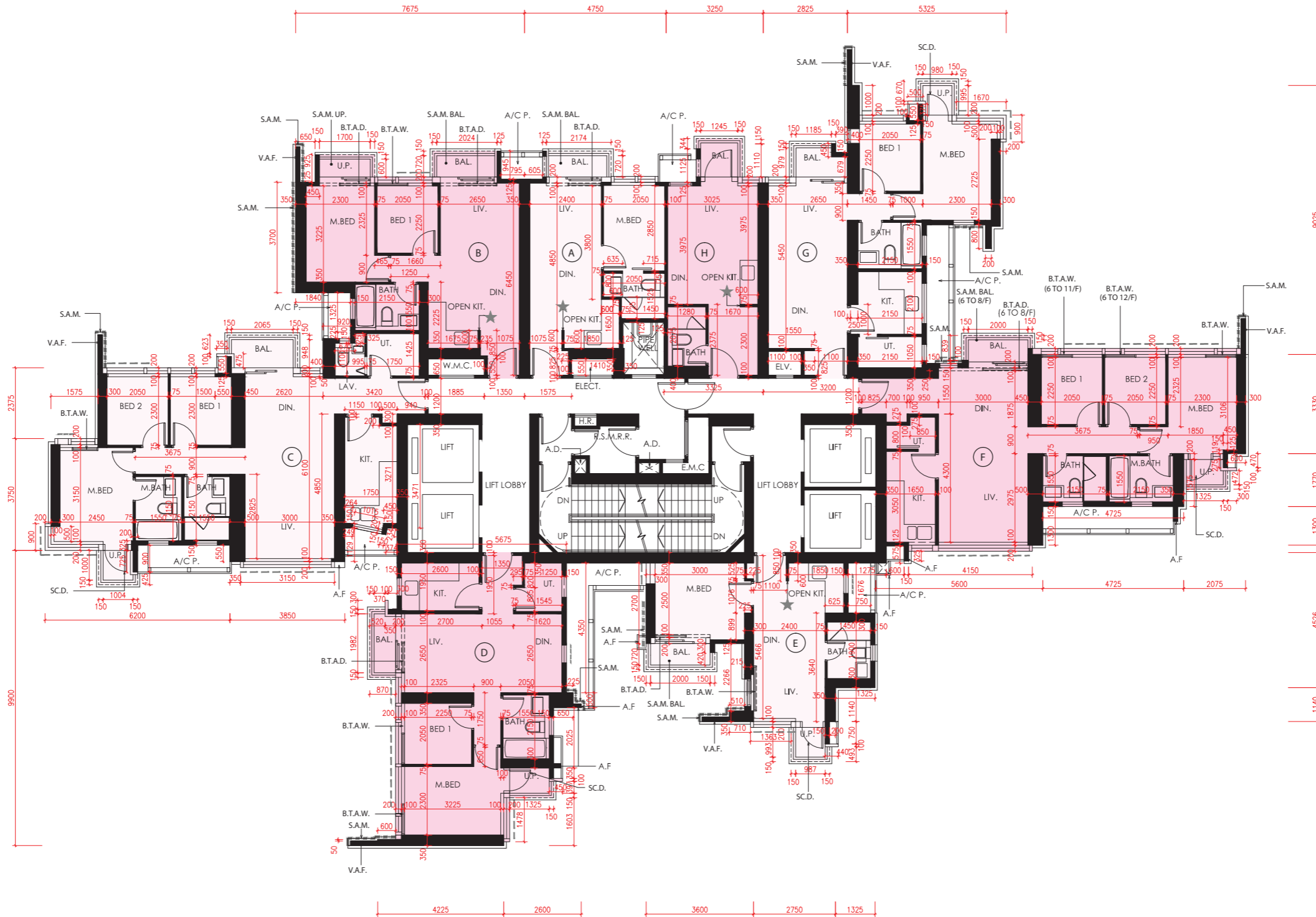

Scale 0 5M/米
比例

Description 描述	Tower 座	Floor 樓層	Unit 單位							
			A	B	C	D	E	F	G	H
The thickness of the floor slabs (excluding plaster) of each residential property (mm) 每個住宅物業的樓板（不包括灰泥）的厚度（毫米）	Tower 2 第2座	6/F - 12/F & 15/F - 22/F (13/F & 14/F are omitted) 6樓 - 12樓 及 15樓 - 22樓 (不設13樓及14樓)	150	150 & 175	150	150	150	150 & 175	150 & 175	150
The floor-to-floor height (refers to the height between the top surface of the structural slab of a floor and the top surface of the structural slab of its immediate upper floor) of each residential property (mm) 每個住宅物業的層與層之間的高度(指該樓層之石屎地台面與上一層石屎地台面之高度距離)（毫米）			3150							
The thickness of the floor slabs (excluding plaster) of each residential property (mm) 每個住宅物業的樓板（不包括灰泥）的厚度（毫米）		150	150 & 175	150 & 200	150		150 & 175		150	
The floor-to-floor height (refers to the height between the top surface of the structural slab of a floor and the top surface of the structural slab of its immediate upper floor) of each residential property (mm) 每個住宅物業的層與層之間的高度(指該樓層之石屎地台面與上一層石屎地台面之高度距離)（毫米）		23/F 23樓	3150, 3200 & 3500	3150 & 3500	3150, 3200 & 3500	3150 & 3500		3150, 3200 & 3500	3150 & 3500	

The internal areas of the residential properties on the upper floors will generally be slightly larger than those on the lower floors because of the reducing thickness of the structural walls on the upper floors.

因住宅物業的較高樓層的結構牆的厚度遞減，較高樓層的內部面積，一般比較低樓層的內部面積稍大。

- The dimensions in the floor plans are all structural dimensions in millimetre and rounded off to the nearest integer.
- Please refer to Page 22-23 of this sales brochure for legend of the terms and abbreviations shown in the floor plan.

- 樓面平面圖之尺規所列數字為以毫米標示之建築結構尺寸，並以四捨五入至整數。
- 平面圖中顯示之名詞及簡稱之圖例請參閱本售樓說明書第22-23頁。

TOWER 2
第2座

26/F - 33/F, 35/F - 43/F & 45/F - 47/F (34/F & 44/F ARE OMITTED)
26樓至33樓、35樓至43樓及45樓至47樓 (不設34樓及44樓)

FLOOR PLAN
樓面平面圖



Scale 0 5M/米
比例

Description 描述	Tower 座	Floor 樓層	Unit 單位							
			A	B	C	D	E	F	G	H
The thickness of the floor slabs (excluding plaster) of each residential property (mm) 每個住宅物業的樓板（不包括灰泥）的厚度（毫米）	Tower 2 第2座	26/F - 33/F, 35/F - 43/F & 45/F - 47/F (34/F & 44/F are omitted) 26樓 - 33樓、35樓 - 43樓 及 45樓 - 47樓 (不設34樓及44樓)	150	150 & 175	150	150	150	150 & 175	150 & 175	150
The floor-to-floor height (refers to the height between the top surface of the structural slab of a floor and the top surface of the structural slab of its immediate upper floor) of each residential property (mm) 每個住宅物業的層與層之間的高度（指該樓層之石屎地台面與上一層石屎地台面之高度距離）（毫米）			3150							

The internal areas of the residential properties on the upper floors will generally be slightly larger than those on the lower floors because of the reducing thickness of the structural walls on the upper floors.

因住宅物業的較高樓層的結構牆的厚度遞減，較高樓層的內部面積，一般比較低樓層的內部面積稍大。

- The dimensions in the floor plans are all structural dimensions in millimetre and rounded off to the nearest integer.
- Please refer to Page 22-23 of this sales brochure for legend of the terms and abbreviations shown in the floor plan.

- 樓面平面圖之尺規所列數字為以毫米標示之建築結構尺寸，並以四捨五入至整數。
- 平面圖中顯示之名詞及簡稱之圖例請參閱本售樓說明書第22-23頁。

TOWER 2
第2座

48/F
48樓

FLOOR PLAN
樓面平面圖



Scale 0 5M/米
比例

Description 描述	Tower 座	Floor 樓層	Unit 單位						
			A	B	C	D	E	F	G
The thickness of the floor slabs (excluding plaster) of each residential property (mm) 每個住宅物業的樓板（不包括灰泥）的厚度（毫米）	Tower 2 第2座	48/F 48樓	150	150 & 175	150	150	150	150 & 175	150
The floor-to-floor height (refers to the height between the top surface of the structural slab of a floor and the top surface of the structural slab of its immediate upper floor) of each residential property (mm) 每個住宅物業的層與層之間的高度（指該樓層之石屎地台面與上一層石屎地台面之高度距離）（毫米）			3150, 3500, 3550 & 3850	3150, 3500 & 3850	3050, 3150, 3200, 3500, 3550 & 3850	3200, 3375 & 3550		3200, 3500, 3550 & 3850	3150, 3500 & 3850

The internal areas of the residential properties on the upper floors will generally be slightly larger than those on the lower floors because of the reducing thickness of the structural walls on the upper floors.

因住宅物業的較高樓層的結構牆的厚度遞減，較高樓層的內部面積，一般比較低樓層的內部面積稍大。

1. The dimensions in the floor plans are all structural dimensions in millimetre and rounded off to the nearest integer.
2. Please refer to Page 22-23 of this sales brochure for legend of the terms and abbreviations shown in the floor plan.

1. 樓面平面圖之尺規所列數字為以毫米標示之建築結構尺寸，並以四捨五入至整數。
2. 平面圖中顯示之名詞及簡稱之圖例請參閱本售樓說明書第22-23頁。

TOWER 2
第2座

49/F
49樓

FLOOR PLAN
樓面平面圖

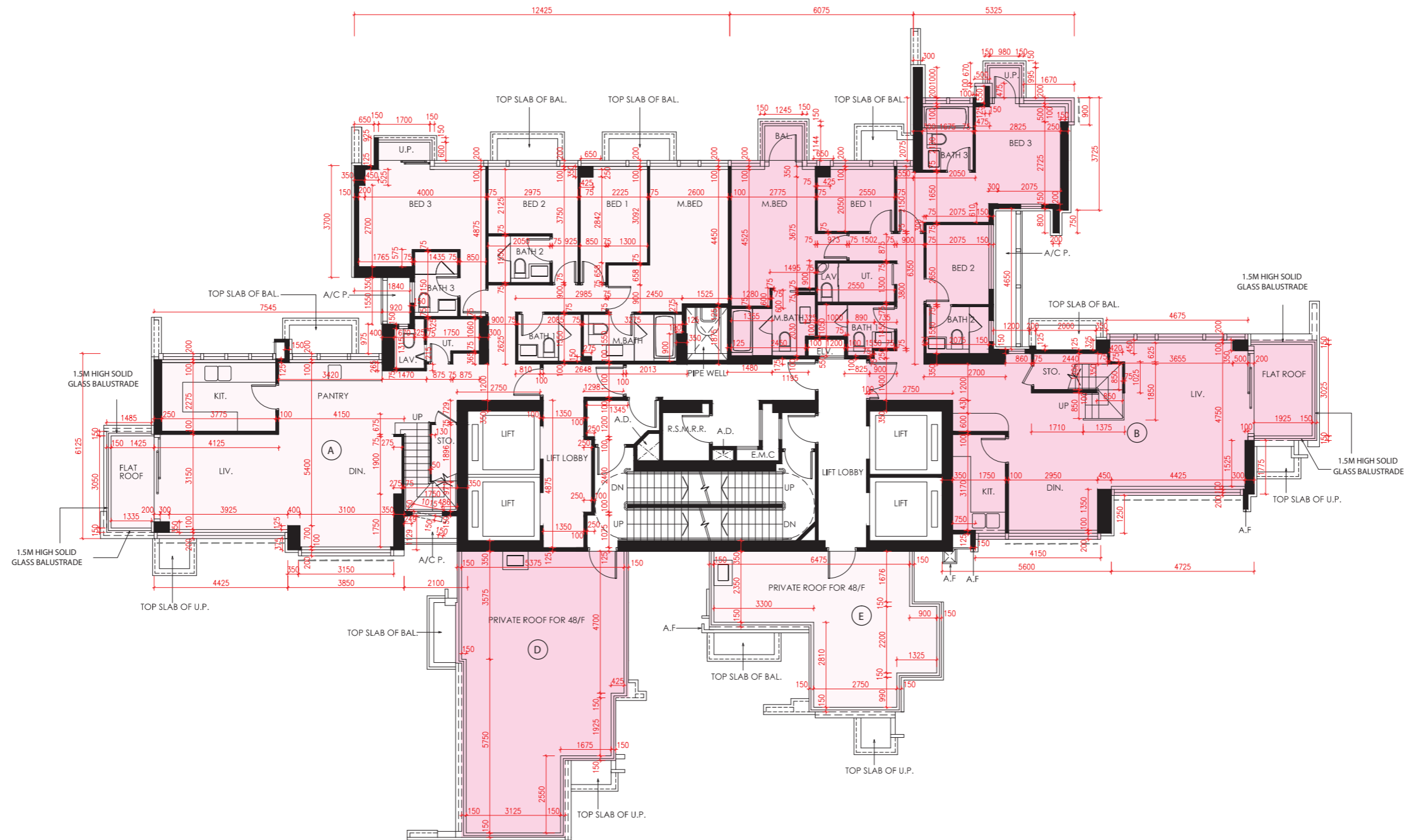

Scale 0 5M/米
比例

Description 描述	Tower 座	Floor 樓層	Unit 單位			
			A	B	D	E
The thickness of the floor slabs (excluding plaster) of each residential property (mm) 每個住宅物業的樓板（不包括灰泥）的厚度（毫米）	Tower 2 第2座	49/F 49樓	150, 175 & 200		Not Applicable 不適用	
The floor-to-floor height (refers to the height between the top surface of the structural slab of a floor and the top surface of the structural slab of its immediate upper floor) of each residential property (mm) 每個住宅物業的層與層之間的高度（指該樓層之石屎地台面與上一層石屎地台面之高度距離）（毫米）			3050, 3500, 3750, 3850 & 3950	3050, 3500, 3525 & 3850	Not Applicable 不適用	

The internal areas of the residential properties on the upper floors will generally be slightly larger than those on the lower floors because of the reducing thickness of the structural walls on the upper floors.

因住宅物業的較高樓層的結構牆的厚度遞減，較高樓層的內部面積，一般比較低樓層的內部面積稍大。

1. The dimensions in the floor plans are all structural dimensions in millimetre and rounded off to the nearest integer.
2. Please refer to Page 22-23 of this sales brochure for legend of the terms and abbreviations shown in the floor plan.

1. 樓面平面圖之尺規所列數字為以毫米標示之建築結構尺寸，並以四捨五入至整數。
2. 平面圖中顯示之名詞及簡稱之圖例請參閱本售樓說明書第22-23頁。

TOWER 2
第2座

ROOF FLOOR PLAN
天台平面圖

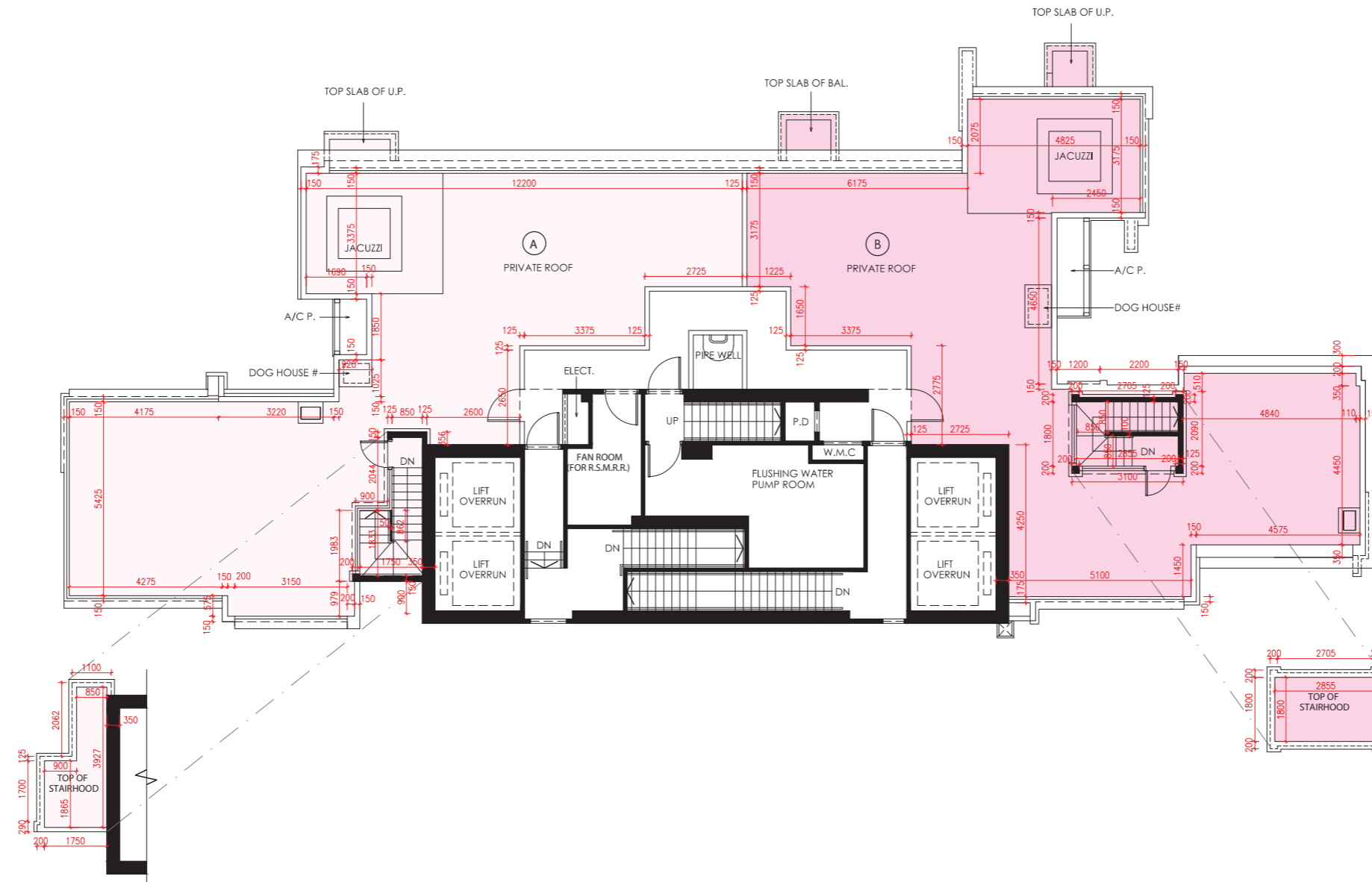

Scale 0 5M/米
比例

Description 描述	Tower 座	Floor 樓層	Unit 單位	
			A	B
The thickness of the floor slabs (excluding plaster) of each residential property (mm) 每個住宅物業的樓板（不包括灰泥）的厚度（毫米）	Tower 2 第2座	Roof 天台	150	
The floor-to-floor height (refers to the height between the top surface of the structural slab of a floor and the top surface of the structural slab of its immediate upper floor) of each residential property (mm) 每個住宅物業的層與層之間的高度（指該樓層之石屎地台面與上一層石屎地台面之高度距離）（毫米）			2700	

The internal areas of the residential properties on the upper floors will generally be slightly larger than those on the lower floors because of the reducing thickness of the structural walls on the upper floors.

因住宅物業的較高樓層的結構牆的厚度遞減，較高樓層的內部面積，一般比較低樓層的內部面積稍大。

1. The dimensions in the floor plans are all structural dimensions in millimetre and rounded off to the nearest integer.
2. Please refer to Page 22-23 of this sales brochure for legend of the terms and abbreviations shown in the floor plan.

1. 樓面平面圖之尺規所列數字為以毫米標示之建築結構尺寸，並以四捨五入至整數。
2. 平面圖中顯示之名詞及簡稱之圖例請參閱本售樓說明書第22-23頁。

TOWER 3
第3座

5/F
5樓

FLOOR PLAN
樓面平面圖

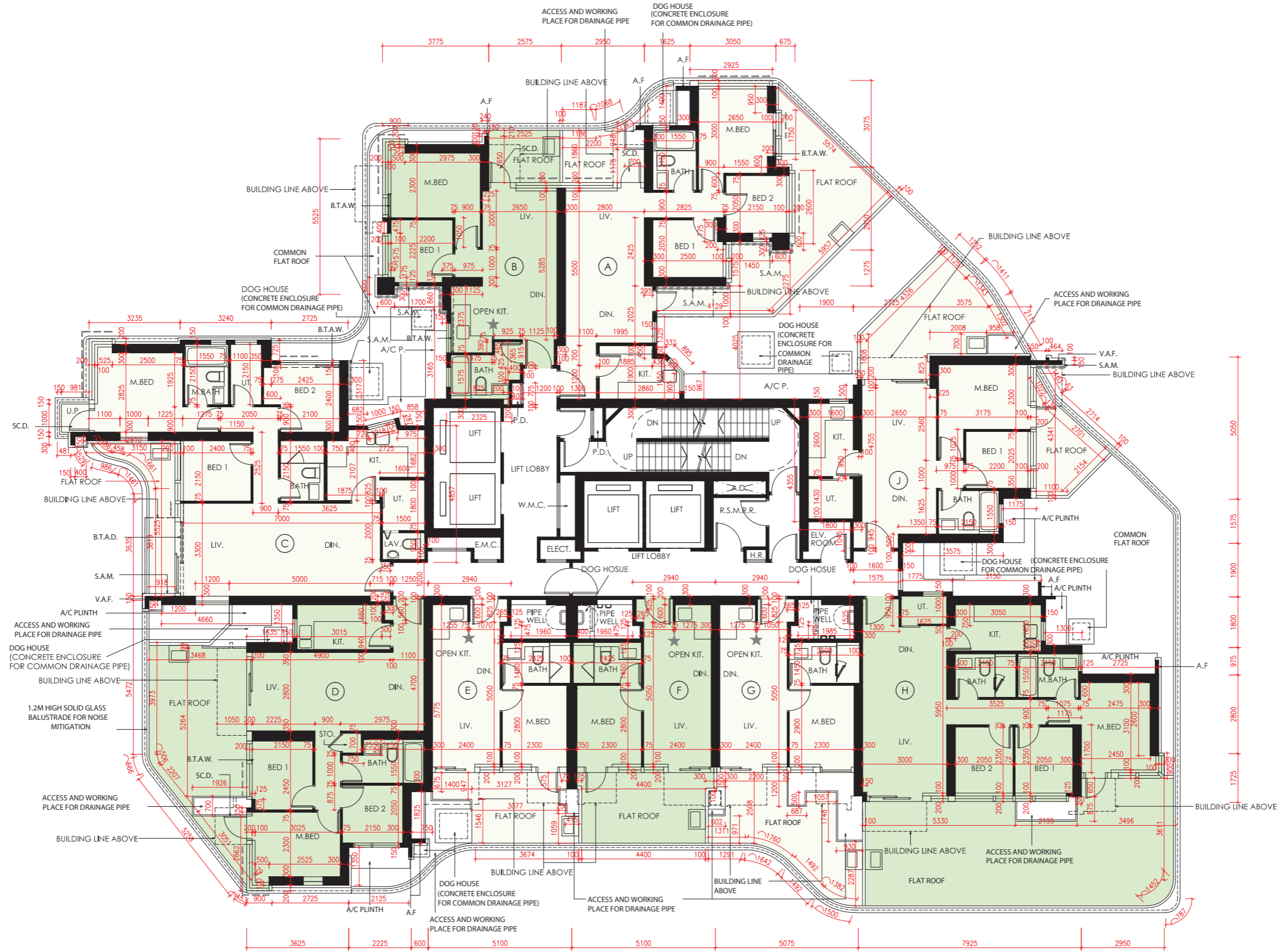

Scale 0 5M/米
比例

Description 描述	Tower 座	Floor 樓層	Unit 單位								
			A	B	C	D	E	F	G	H	J
The thickness of the floor slabs (excluding plaster) of each residential property (mm) 每個住宅物業的樓板（不包括灰泥）的厚度（毫米）	Tower 3 第3座	5/F 5樓	150	150 & 175		150	150 & 200			150	150 & 175
The floor-to-floor height (refers to the height between the top surface of the structural slab of a floor and the top surface of the structural slab of its immediate upper floor) of each residential property (mm) 每個住宅物業的層與層之間的高度（指該樓層之石屎地台面與上一層石屎地台面之高度距離）（毫米）			2800, 3150 & 3475		2800, 3100, 3150 & 3475	2800, 3150 & 3475	2800, 3100, 3150 & 3475			2800, 3150 & 3475	

The internal areas of the residential properties on the upper floors will generally be slightly larger than those on the lower floors because of the reducing thickness of the structural walls on the upper floors.

因住宅物業的較高樓層的結構牆的厚度遞減，較高樓層的內部面積，一般比較低樓層的內部面積稍大。

Notes:

- The dimensions in the floor plans are all structural dimensions in millimetre and rounded off to the nearest integer.
- Please refer to Page 22-23 of this sales brochure for legend of the terms and abbreviations shown in the floor plan.
- Blank areas on the Flat roof are common areas that only the Manager shall have access in performance of its duty and exercise of its power.
- In relation to the Flat roofs of Units A, D, E, G, H & J of Tower 3, there are certain Residential Common Areas marked "Access and Working Place for Drainage Pipe" and "Concrete Enclosure for Common Drainage Pipe" which have to be accessed through certain Residential Units on the 5th Floor of the Tower.

備註：

- 樓面平面圖之尺規所列數字為以毫米標示之建築結構尺寸，並以四捨五入至整數。
- 平面圖中顯示之名詞及簡稱之圖例請參閱本售樓說明書第22-23頁。
- 平台空白位置只供管理人為履行其職責及行使權力而進入。
- 有關發展項目第3座5樓A、D、E、G、H及J單位平台存在某些住宅公用地方並以「排水管道維修空間」及「公共排水管道的混凝土圍封」標記，並且需經由某些於該座5樓住宅單位而進入。

TOWER 3
第3座

6/F - 12/F & 15/F - 23/F (13/F & 14/F ARE OMITTED)
6樓至12樓及15樓至23樓 (不設13樓及14樓)

FLOOR PLAN
樓面平面圖



Scale 0 5M/米
比例

Description 描述	Tower 座	Floor 樓層	Unit 單位							
			A	B	C	D	E	F	G	H
The thickness of the floor slabs (excluding plaster) of each residential property (mm) 每個住宅物業的樓板（不包括灰泥）的厚度（毫米）	Tower 3 第3座	6/F - 12/F & 15/F - 22/F (13/F & 14/F are omitted) 6樓 - 12樓 及 15樓 - 22樓 (不設13樓及14樓)	150	150 & 175	150 & 175	150	150 & 200		150	150 & 175
The floor-to-floor height (refers to the height between the top surface of the structural slab of a floor and the top surface of the structural slab of its immediate upper floor) of each residential property (mm) 每個住宅物業的層與層之間的高度（指該樓層之石屎地台面與上一層石屎地台面之高度距離）（毫米）			3150							
The thickness of the floor slabs (excluding plaster) of each residential property (mm) 每個住宅物業的樓板（不包括灰泥）的厚度（毫米）		150	150 & 200	150 & 175	150	150 & 200		150	150 & 175	
The floor-to-floor height (refers to the height between the top surface of the structural slab of a floor and the top surface of the structural slab of its immediate upper floor) of each residential property (mm) 每個住宅物業的層與層之間的高度（指該樓層之石屎地台面與上一層石屎地台面之高度距離）（毫米）		23/F 23樓	3150 & 3500	3150	3150, 3200 & 3500	3150 & 3500	3150, 3200 & 3500		3150 & 3500	

The internal areas of the residential properties on the upper floors will generally be slightly larger than those on the lower floors because of the reducing thickness of the structural walls on the upper floors.

因住宅物業的較高樓層的結構牆的厚度遞減，較高樓層的內部面積，一般比較低樓層的內部面積稍大。

- The dimensions in the floor plans are all structural dimensions in millimetre and rounded off to the nearest integer.
- Please refer to Page 22-23 of this sales brochure for legend of the terms and abbreviations shown in the floor plan.

- 樓面平面圖之尺規所列數字為以毫米標示之建築結構尺寸，並以四捨五入至整數。
- 平面圖中顯示之名詞及簡稱之圖例請參閱本售樓說明書第22-23頁。

TOWER 3
第3座

26/F - 33/F, 35/F - 43/F & 45/F - 49/F (34/F & 44/F ARE OMITTED)
26樓至33樓、35樓至43樓及45樓至49樓 (不設34樓及44樓)

FLOOR PLAN
樓面平面圖



Scale 0 5M/米
比例

Description 描述	Tower 座	Floor 樓層	Unit 單位							
			A	B	C	D	E	F	G	H
The thickness of the floor slabs (excluding plaster) of each residential property (mm) 每個住宅物業的樓板（不包括灰泥）的厚度（毫米）	Tower 3 第3座	26/F - 33/F, 35/F - 43/F & 45/F - 48/F (34/F & 44/F are omitted) 26樓 - 33樓、35樓 - 43樓 及 45樓 - 48樓 (不設34樓及44樓)	150	150 & 175	150 & 175	150	150 & 200		150	150 & 175
The floor-to-floor height (refers to the height between the top surface of the structural slab of a floor and the top surface of the structural slab of its immediate upper floor) of each residential property (mm) 每個住宅物業的層與層之間的高度（指該樓層之石屎地台面與上一層石屎地台面之高度距離）（毫米）			3150							
The thickness of the floor slabs (excluding plaster) of each residential property (mm) 每個住宅物業的樓板（不包括灰泥）的厚度（毫米）		150	150 & 175	150 & 200	150	150 & 200		150	150 & 175	
The floor-to-floor height (refers to the height between the top surface of the structural slab of a floor and the top surface of the structural slab of its immediate upper floor) of each residential property (mm) 每個住宅物業的層與層之間的高度（指該樓層之石屎地台面與上一層石屎地台面之高度距離）（毫米）		49/F 49樓	2800, 3150 & 3500	2800, 2850, 3150, 3200 & 3500	2800, 2850, 3150 & 3500	2800, 3150, 3200 & 3500	3150 & 3200	2800, 3150, 3200 & 3500	2800, 2850, 3150, 3200 & 3500	3150

The internal areas of the residential properties on the upper floors will generally be slightly larger than those on the lower floors because of the reducing thickness of the structural walls on the upper floors.

因住宅物業的較高樓層的結構牆的厚度遞減，較高樓層的內部面積，一般比較低樓層的內部面積稍大。

- The dimensions in the floor plans are all structural dimensions in millimetre and rounded off to the nearest integer.
- Please refer to Page 22-23 of this sales brochure for legend of the terms and abbreviations shown in the floor plan.

- 樓面平面圖之尺規所列數字為以毫米標示之建築結構尺寸，並以四捨五入至整數。
- 平面圖中顯示之名詞及簡稱之圖例請參閱本售樓說明書第22-23頁。

TOWER 3
第3座

50/F
50樓

FLOOR PLAN
樓面平面圖

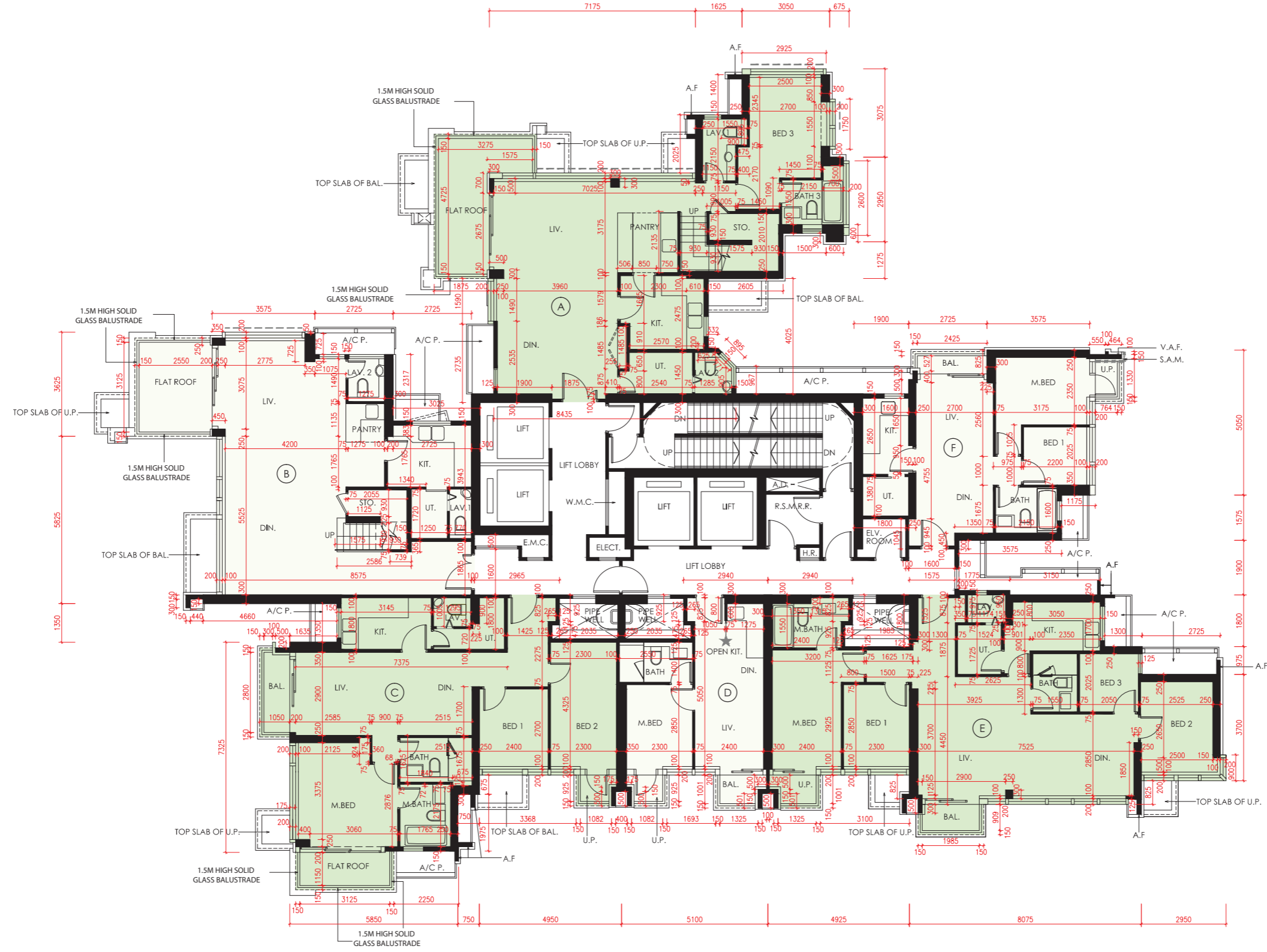

Scale 0 5M/米
比例

Description 描述	Tower 座	Floor 樓層	Unit 單位					
			A	B	C	D	E	F
The thickness of the floor slabs (excluding plaster) of each residential property (mm) 每個住宅物業的樓板（不包括灰泥）的厚度（毫米）	Tower 3 第3座	50/F 50樓	150, 200 & 250	150	150 & 200		150, 200 & 250	150 & 175
The floor-to-floor height (refers to the height between the top surface of the structural slab of a floor and the top surface of the structural slab of its immediate upper floor) of each residential property (mm) 每個住宅物業的層與層之間的高度（指該樓層之石屎地台面與上一層石屎地台面之高度距離）（毫米）			3150, 3500 & 3850			3500		

The internal areas of the residential properties on the upper floors will generally be slightly larger than those on the lower floors because of the reducing thickness of the structural walls on the upper floors.

因住宅物業的較高樓層的結構牆的厚度遞減，較高樓層的內部面積，一般比較低樓層的內部面積稍大。

1. The dimensions in the floor plans are all structural dimensions in millimetre and rounded off to the nearest integer.
2. Please refer to Page 22-23 of this sales brochure for legend of the terms and abbreviations shown in the floor plan.

1. 樓面平面圖之尺規所列數字為以毫米標示之建築結構尺寸，並以四捨五入至整數。
2. 平面圖中顯示之名詞及簡稱之圖例請參閱本售樓說明書第22-23頁。

TOWER 3
第3座

51/F
51樓

FLOOR PLAN
樓面平面圖



Scale 0 5M/米
比例

Description 描述	Tower 座	Floor 樓層	Unit 單位					
			A	B	C	D	E	F
The thickness of the floor slabs (excluding plaster) of each residential property (mm) 每個住宅物業的樓板（不包括灰泥）的厚度（毫米）	Tower 3 第3座	51/F 51樓	150, 175 & 200	150 & 200			150, 200 & 250	150 & 175
The floor-to-floor height (refers to the height between the top surface of the structural slab of a floor and the top surface of the structural slab of its immediate upper floor) of each residential property (mm) 每個住宅物業的層與層之間的高度（指該樓層之石屎地台面與上一層石屎地台面之高度距離）（毫米）			3050, 3400, 3500 & 3850	3050, 3500 & 3850	3500 & 3850	3500, 3850, 3900 & 4250		3500 & 3850

The internal areas of the residential properties on the upper floors will generally be slightly larger than those on the lower floors because of the reducing thickness of the structural walls on the upper floors.

因住宅物業的較高樓層的結構牆的厚度遞減，較高樓層的內部面積，一般比較低樓層的內部面積稍大。

1. The dimensions in the floor plans are all structural dimensions in millimetre and rounded off to the nearest integer.
2. Please refer to Page 22-23 of this sales brochure for legend of the terms and abbreviations shown in the floor plan.

1. 樓面平面圖之尺規所列數字為以毫米標示之建築結構尺寸，並以四捨五入至整數。
2. 平面圖中顯示之名詞及簡稱之圖例請參閱本售樓說明書第22-23頁。

TOWER 3
第3座

ROOF FLOOR PLAN
天台平面圖

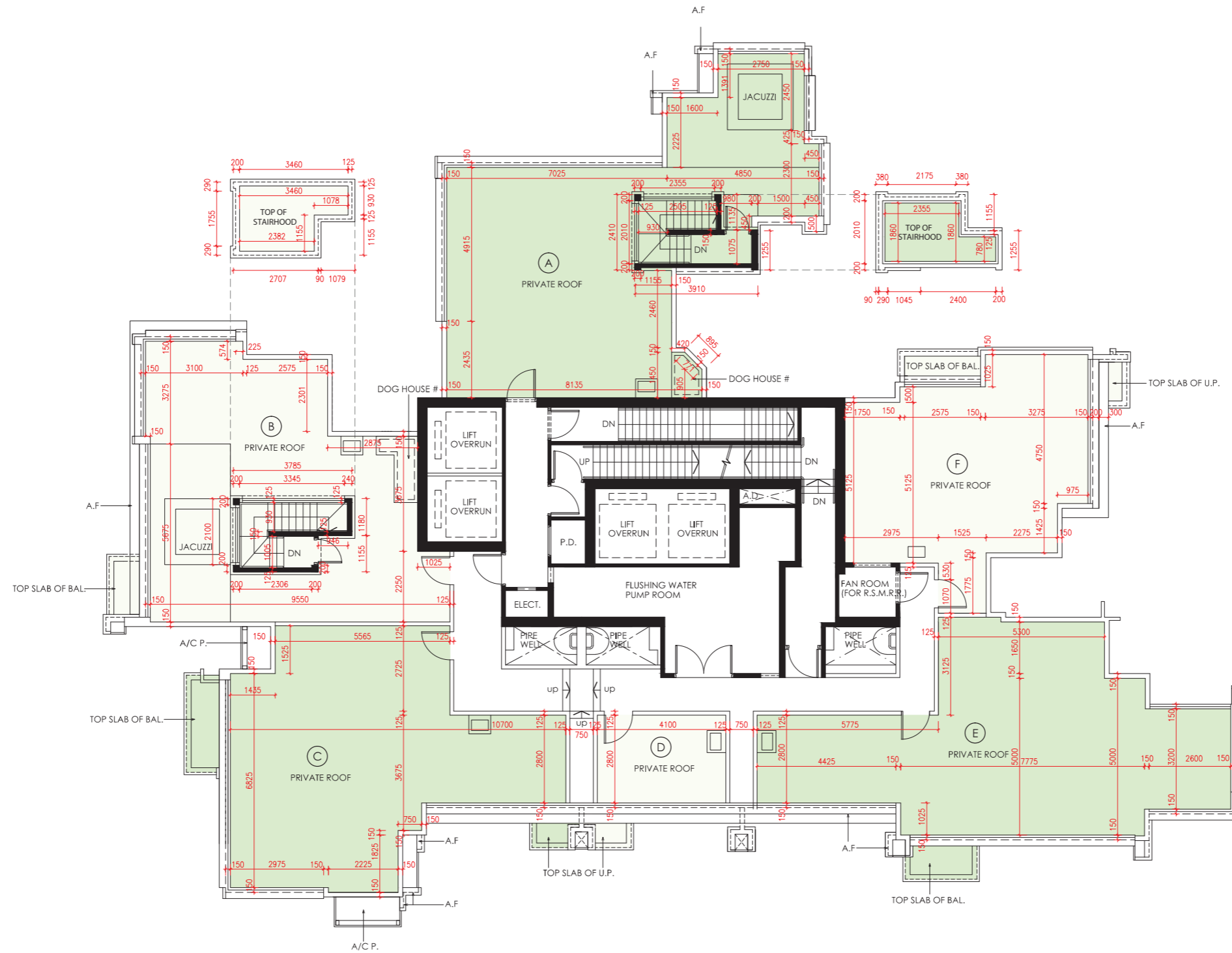

Scale 0 5M/米
比例

Description 描述	Tower 座	Floor 樓層	Unit 單位					
			A	B	C	D	E	F
The thickness of the floor slabs (excluding plaster) of each residential property (mm) 每個住宅物業的樓板（不包括灰泥）的厚度（毫米）	Tower 3 第3座	Roof 天台	150		Not Applicable 不適用			
The floor-to-floor height (refers to the height between the top surface of the structural slab of a floor and the top surface of the structural slab of its immediate upper floor) of each residential property (mm) 每個住宅物業的層與層之間的高度（指該樓層之石屎地台面與上一層石屎地台面之高度距離）（毫米）			2700		Not Applicable 不適用			

The internal areas of the residential properties on the upper floors will generally be slightly larger than those on the lower floors because of the reducing thickness of the structural walls on the upper floors.

因住宅物業的較高樓層的結構牆的厚度遞減，較高樓層的內部面積，一般比較低樓層的內部面積稍大。

1. The dimensions in the floor plans are all structural dimensions in millimetre and rounded off to the nearest integer.
2. Please refer to Page 22-23 of this sales brochure for legend of the terms and abbreviations shown in the floor plan.

1. 樓面平面圖之尺規所列數字為以毫米標示之建築結構尺寸，並以四捨五入至整數。
2. 平面圖中顯示之名詞及簡稱之圖例請參閱本售樓說明書第22-23頁。

TOWER 5
第5座

5/F
5樓

FLOOR PLAN
樓面平面圖

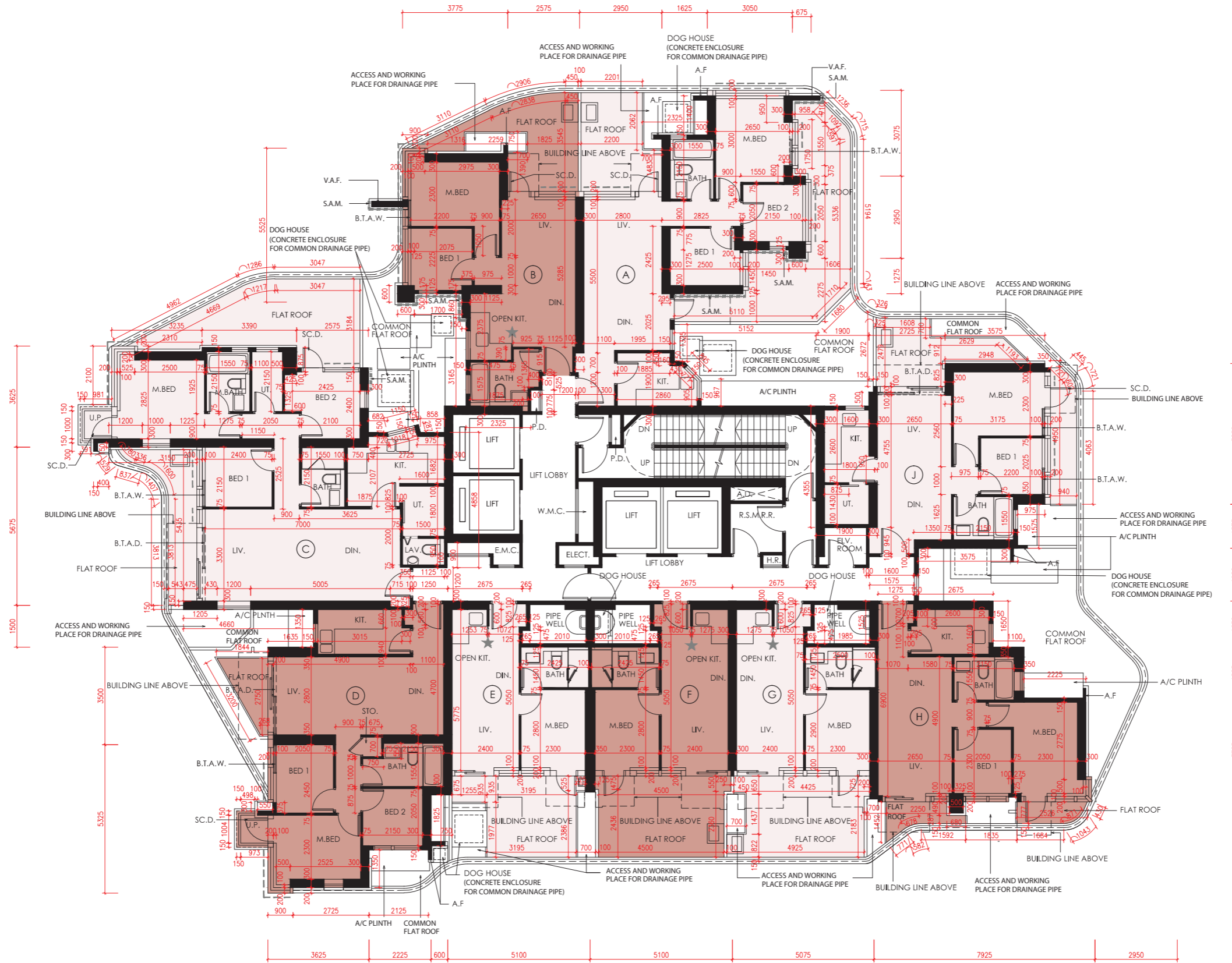

Scale 0 5M/米
比例

Description 描述	Tower 座	Floor 樓層	Unit 單位								
			A	B	C	D	E	F	G	H	J
The thickness of the floor slabs (excluding plaster) of each residential property (mm) 每個住宅物業的樓板（不包括灰泥）的厚度（毫米）	Tower 5 第5座	5/F 5樓	150	150 & 175		150	150 & 200			150	150 & 175
The floor-to-floor height (refers to the height between the top surface of the structural slab of a floor and the top surface of the structural slab of its immediate upper floor) of each residential property (mm) 每個住宅物業的層與層之間的高度（指該樓層之石屎地台面與上一層石屎地台面之高度距離）（毫米）			2800, 3150 & 3475		2800, 3100, 3150 & 3475	2800, 3150 & 3475	2800, 3100, 3150 & 3475			2800, 3150 & 3475	

The internal areas of the residential properties on the upper floors will generally be slightly larger than those on the lower floors because of the reducing thickness of the structural walls on the upper floors.

因住宅物業的較高樓層的結構牆的厚度遞減，較高樓層的內部面積，一般比較低樓層的內部面積稍大。

Notes:

- The dimensions in the floor plans are all structural dimensions in millimetre and rounded off to the nearest integer.
- Please refer to Page 22-23 of this sales brochure for legend of the terms and abbreviations shown in the floor plan.
- Blank areas on the Flat roof are common areas that only the Manager shall have access in performance of its duty and exercise of its power.
- In relation to the Flat roofs of Units A, B, D, E, G, H & J of Tower 5, there are certain Residential Common Areas marked "Access and Working Place for Drainage Pipe" and "Concrete Enclosure for Common Drainage Pipe" which have to be accessed through certain Residential Units on the 5th Floor of the Tower.

備註：

- 樓面平面圖之尺規所列數字為以毫米標示之建築結構尺寸，並以四捨五入至整數。
- 平面圖中顯示之名詞及簡稱之圖例請參閱本售樓說明書第22-23頁。
- 平台空白位置只供管理人為履行其職責及行使權力而進入。
- 有關發展項目第5座5樓A、B、D、E、G、H及J單位平台存在某些住宅公用地方並以「排水管道維修空間」及「公共排水管道的混凝土圍封」標記，並且需經由某些於該座5樓住宅單位而進入。

TOWER 5
第5座

6/F - 12/F & 15/F - 23/F (13/F & 14/F ARE OMITTED)
6樓至12樓及15樓至23樓 (不設13樓及14樓)

FLOOR PLAN
樓面平面圖

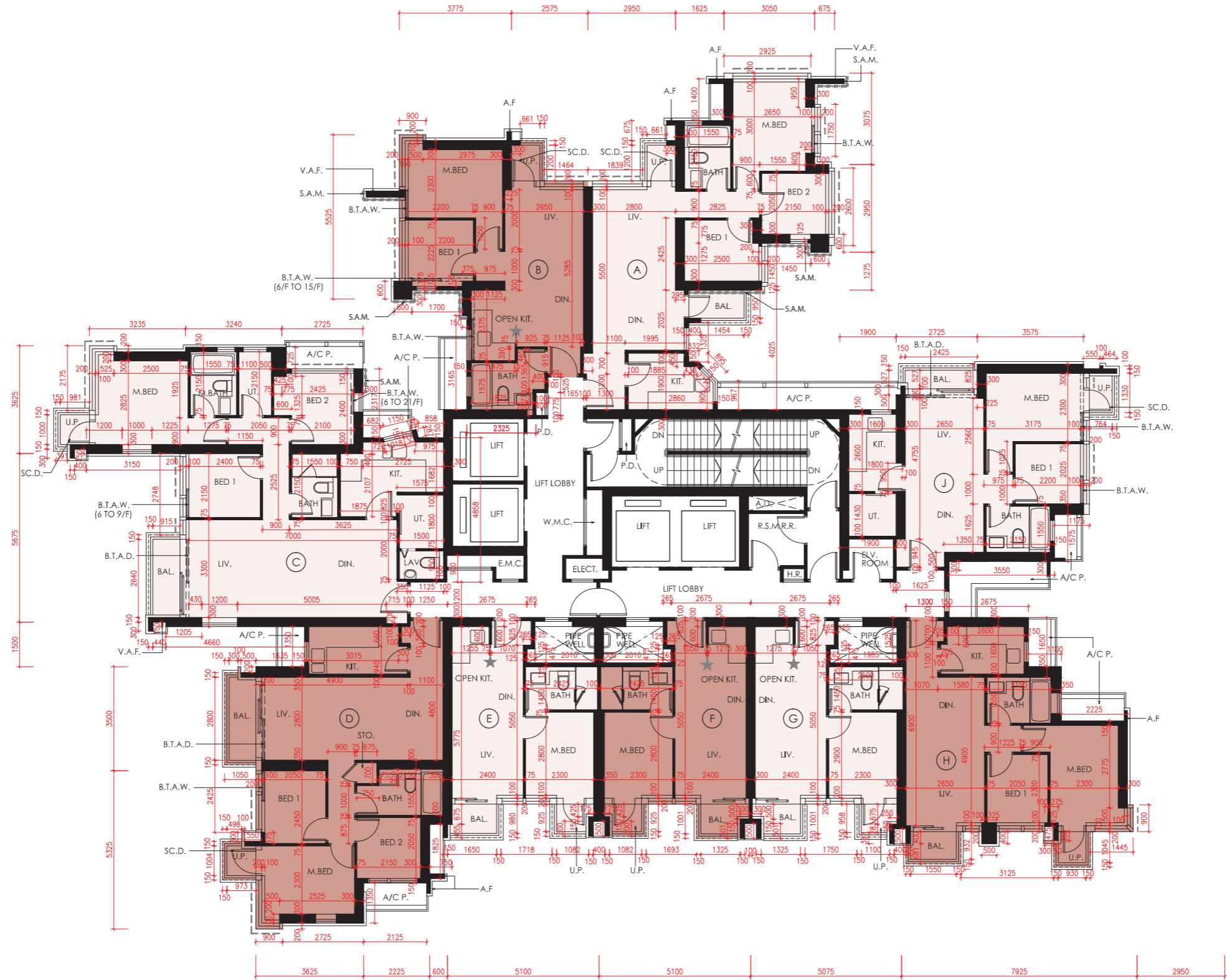

Scale 0 5M/米
比例

Description 描述	Tower 座	Floor 樓層	Unit 單位							
			A	B	C	D	E	F	G	H
The thickness of the floor slabs (excluding plaster) of each residential property (mm) 每個住宅物業的樓板（不包括灰泥）的厚度（毫米）	Tower 5 第5座	6/F - 12/F & 15/F - 22/F (13/F & 14/F are omitted) 6樓 - 12樓 及 15樓 - 22樓 (不設13樓及14樓)	150	150 & 175	150 & 175	150	150 & 200		150	150 & 175
The floor-to-floor height (refers to the height between the top surface of the structural slab of a floor and the top surface of the structural slab of its immediate upper floor) of each residential property (mm) 每個住宅物業的層與層之間的高度（指該樓層之石屎地台面與上一層石屎地台面之高度距離）（毫米）			3150							
The thickness of the floor slabs (excluding plaster) of each residential property (mm) 每個住宅物業的樓板（不包括灰泥）的厚度（毫米）		150	150 & 200	150 & 175	150	150 & 200		150	150 & 175	
The floor-to-floor height (refers to the height between the top surface of the structural slab of a floor and the top surface of the structural slab of its immediate upper floor) of each residential property (mm) 每個住宅物業的層與層之間的高度（指該樓層之石屎地台面與上一層石屎地台面之高度距離）（毫米）		23/F 23樓	3150 & 3500	3150	3150, 3200 & 3500	3150 & 3500	3150, 3200 & 3500		3150 & 3500	

The internal areas of the residential properties on the upper floors will generally be slightly larger than those on the lower floors because of the reducing thickness of the structural walls on the upper floors.

因住宅物業的較高樓層的結構牆的厚度遞減，較高樓層的內部面積，一般比較低樓層的內部面積稍大。

- The dimensions in the floor plans are all structural dimensions in millimetre and rounded off to the nearest integer.
- Please refer to Page 22-23 of this sales brochure for legend of the terms and abbreviations shown in the floor plan.

- 樓面平面圖之尺規所列數字為以毫米標示之建築結構尺寸，並以四捨五入至整數。
- 平面圖中顯示之名詞及簡稱之圖例請參閱本售樓說明書第22-23頁。

TOWER 5
第5座

26/F - 33/F, 35/F - 43/F & 45/F - 49/F (34/F & 44/F ARE OMITTED)
26樓至33樓、35樓至43樓及45樓至49樓 (不設34樓及44樓)

FLOOR PLAN
樓面平面圖



Scale 0 5M/米
比例

Description 描述	Tower 座	Floor 樓層	Unit 單位							
			A	B	C	D	E	F	G	H
The thickness of the floor slabs (excluding plaster) of each residential property (mm) 每個住宅物業的樓板（不包括灰泥）的厚度（毫米）	Tower 5 第5座	26/F - 33/F, 35/F - 43/F & 45/F - 48/F (34/F & 44/F are omitted) 26樓 - 33樓、35樓 - 43樓 及 45樓 - 48樓 (不設34樓及44樓)	150	150 & 175	150 & 175	150	150 & 200		150	150 & 175
The floor-to-floor height (refers to the height between the top surface of the structural slab of a floor and the top surface of the structural slab of its immediate upper floor) of each residential property (mm) 每個住宅物業的層與層之間的高度（指該樓層之石屎地台面與上一層石屎地台面之高度距離）（毫米）			3150							
The thickness of the floor slabs (excluding plaster) of each residential property (mm) 每個住宅物業的樓板（不包括灰泥）的厚度（毫米）		150	150 & 175	150 & 200	150	150 & 200		150	150 & 175	
The floor-to-floor height (refers to the height between the top surface of the structural slab of a floor and the top surface of the structural slab of its immediate upper floor) of each residential property (mm) 每個住宅物業的層與層之間的高度（指該樓層之石屎地台面與上一層石屎地台面之高度距離）（毫米）		49/F 49樓	2800, 3150 & 3500	2800, 3150 & 3500	2800, 2850, 3150, 3200 & 3500	3150	3150 & 3200	2800, 3150, 3200 & 3500	2800, 3150, 3200 & 3500	3150 & 3500

The internal areas of the residential properties on the upper floors will generally be slightly larger than those on the lower floors because of the reducing thickness of the structural walls on the upper floors.

因住宅物業的較高樓層的結構牆的厚度遞減，較高樓層的內部面積，一般比較低樓層的內部面積稍大。

- The dimensions in the floor plans are all structural dimensions in millimetre and rounded off to the nearest integer.
- Please refer to Page 22-23 of this sales brochure for legend of the terms and abbreviations shown in the floor plan.

- 樓面平面圖之尺規所列數字為以毫米標示之建築結構尺寸，並以四捨五入至整數。
- 平面圖中顯示之名詞及簡稱之圖例請參閱本售樓說明書第22-23頁。

TOWER 5
第5座

50/F
50樓

FLOOR PLAN
樓面平面圖

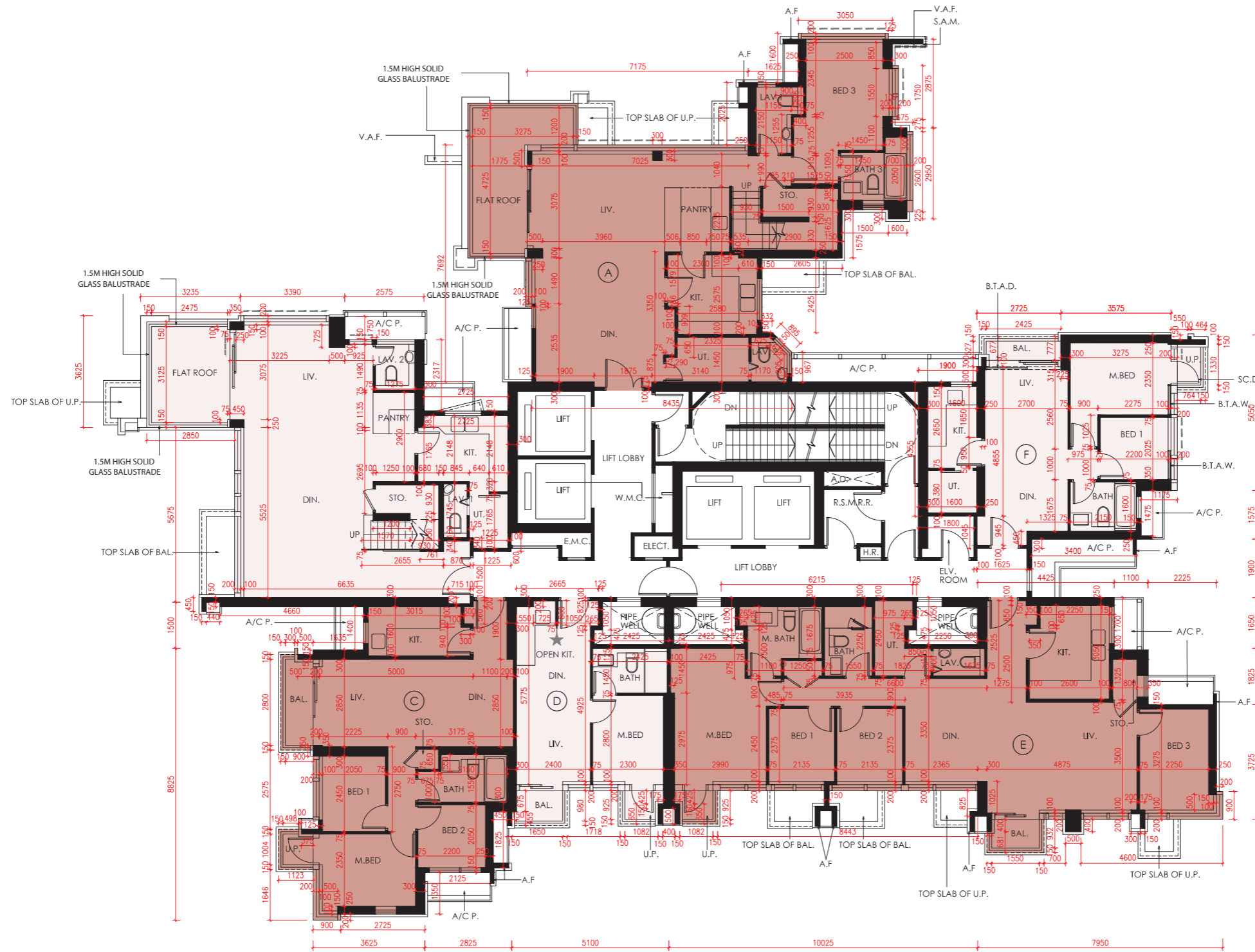

Scale 0 5M/米
比例

Description 描述	Tower 座	Floor 樓層	Unit 單位					
			A	B	C	D	E	F
The thickness of the floor slabs (excluding plaster) of each residential property (mm) 每個住宅物業的樓板（不包括灰泥）的厚度（毫米）	Tower 5 第5座	50/F 50樓	150 & 200	150		150 & 200	150, 175 & 200	150 & 175
The floor-to-floor height (refers to the height between the top surface of the structural slab of a floor and the top surface of the structural slab of its immediate upper floor) of each residential property (mm) 每個住宅物業的層與層之間的高度（指該樓層之石屎地台面與上一層石屎地台面之高度距離）（毫米）			3150, 3500 & 3850	3050, 3150, 3400, 3500 & 3850	3500		3150, 3500 & 3850	3500

The internal areas of the residential properties on the upper floors will generally be slightly larger than those on the lower floors because of the reducing thickness of the structural walls on the upper floors.

因住宅物業的較高樓層的結構牆的厚度遞減，較高樓層的內部面積，一般比較低樓層的內部面積稍大。

1. The dimensions in the floor plans are all structural dimensions in millimetre and rounded off to the nearest integer.
2. Please refer to Page 22-23 of this sales brochure for legend of the terms and abbreviations shown in the floor plan.

1. 樓面平面圖之尺規所列數字為以毫米標示之建築結構尺寸，並以四捨五入至整數。
2. 平面圖中顯示之名詞及簡稱之圖例請參閱本售樓說明書第22-23頁。

TOWER 5
第5座

51/F
51樓

FLOOR PLAN
樓面平面圖

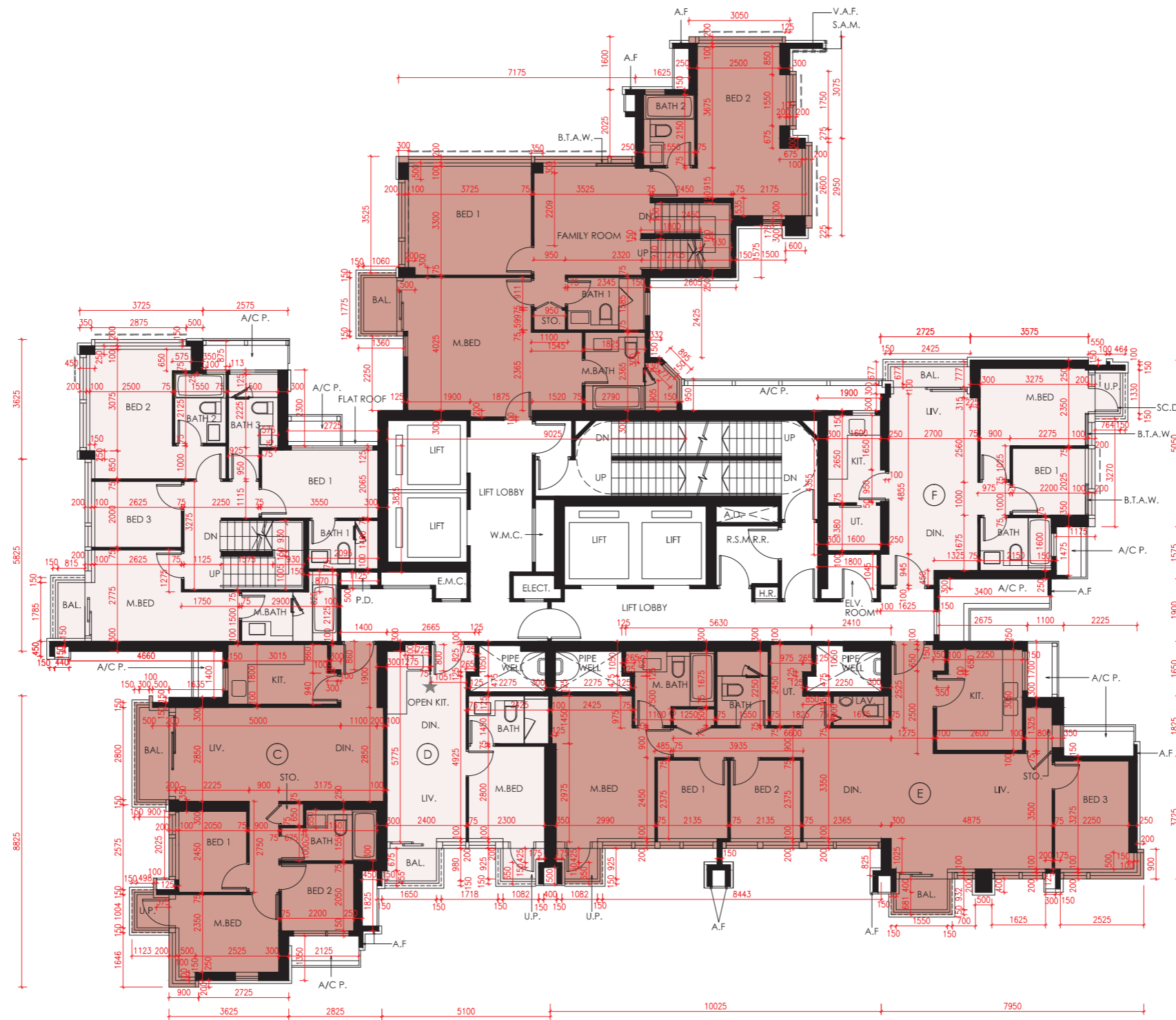

Scale 0 5M/米
比例

Description 描述	Tower 座	Floor 樓層	Unit 單位					
			A	B	C	D	E	F
The thickness of the floor slabs (excluding plaster) of each residential property (mm) 每個住宅物業的樓板（不包括灰泥）的厚度（毫米）	Tower 5 第5座	51/F 51樓	150, 175 & 200	150 & 200	150	150 & 200	150, 175 & 200	150 & 175
The floor-to-floor height (refers to the height between the top surface of the structural slab of a floor and the top surface of the structural slab of its immediate upper floor) of each residential property (mm) 每個住宅物業的層與層之間的高度（指該樓層之石屎地台面與上一層石屎地台面之高度距離）（毫米）			3050, 3400, 3500 & 3850	3050, 3500, 3850 & 3950	3500 & 3850	3500, 3850, 3900 & 4250	3500 & 3850	

The internal areas of the residential properties on the upper floors will generally be slightly larger than those on the lower floors because of the reducing thickness of the structural walls on the upper floors.

因住宅物業的較高樓層的結構牆的厚度遞減，較高樓層的內部面積，一般比較低樓層的內部面積稍大。

1. The dimensions in the floor plans are all structural dimensions in millimetre and rounded off to the nearest integer.
2. Please refer to Page 22-23 of this sales brochure for legend of the terms and abbreviations shown in the floor plan.

1. 樓面平面圖之尺規所列數字為以毫米標示之建築結構尺寸，並以四捨五入至整數。
2. 平面圖中顯示之名詞及簡稱之圖例請參閱本售樓說明書第22-23頁。

TOWER 5 第5座

ROOF FLOOR PLAN 天台平面圖

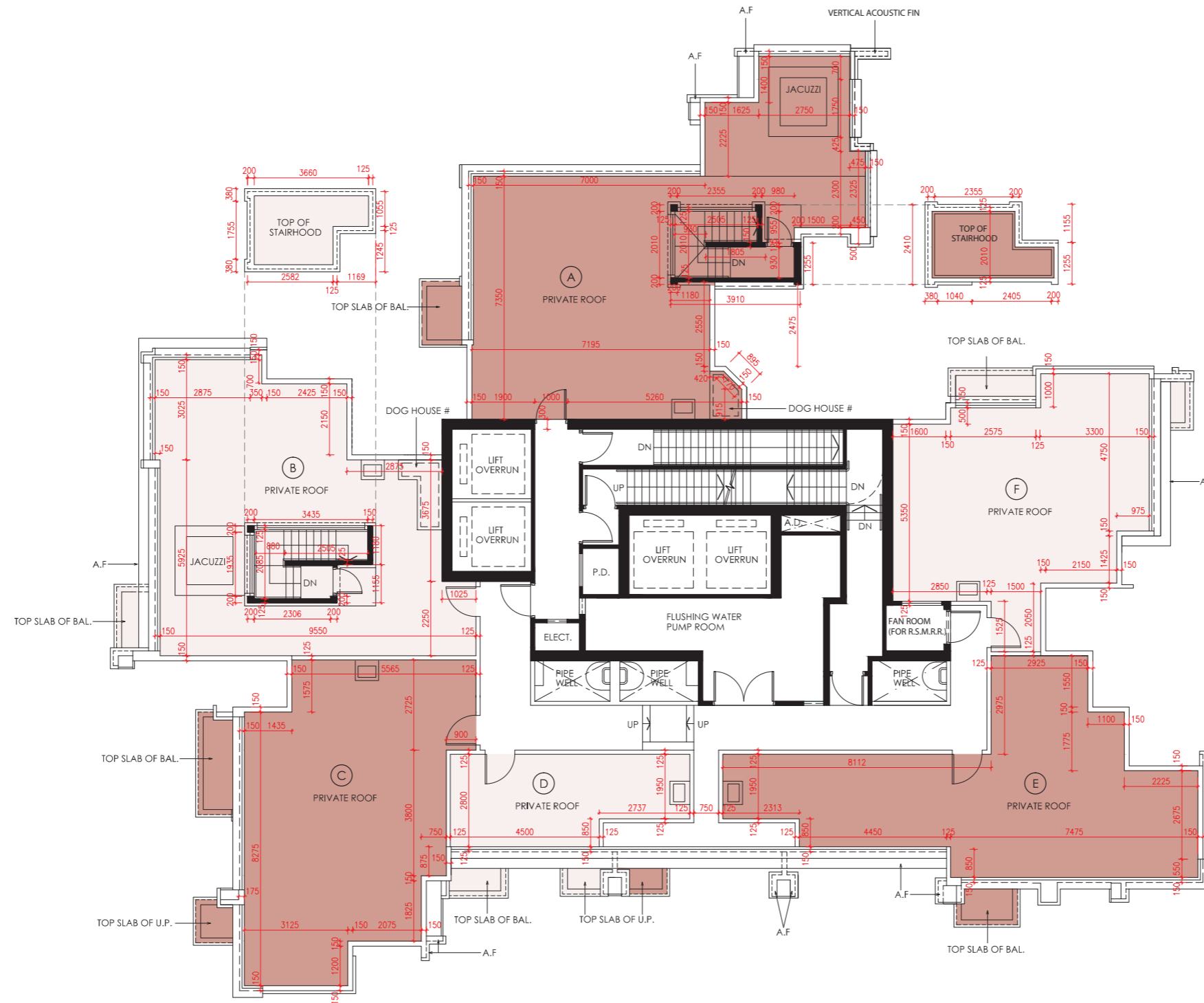

Scale 0 5M/米
比例

Description 描述	Tower 座	Floor 樓層	Unit 單位					
			A	B	C	D	E	F
The thickness of the floor slabs (excluding plaster) of each residential property (mm) 每個住宅物業的樓板（不包括灰泥）的厚度（毫米）	Tower 5 第5座	Roof 天台	150		Not Applicable 不適用			
The floor-to-floor height (refers to the height between the top surface of the structural slab of a floor and the top surface of the structural slab of its immediate upper floor) of each residential property (mm) 每個住宅物業的層與層之間的高度（指該樓層之石屎地台面與上一層石屎地台面之高度距離）（毫米）			2700		Not Applicable 不適用			

The internal areas of the residential properties on the upper floors will generally be slightly larger than those on the lower floors because of the reducing thickness of the structural walls on the upper floors.

因住宅物業的較高樓層的結構牆的厚度遞減，較高樓層的內部面積，一般比較低樓層的內部面積稍大。

- The dimensions in the floor plans are all structural dimensions in millimetre and rounded off to the nearest integer.
- Please refer to Page 22-23 of this sales brochure for legend of the terms and abbreviations shown in the floor plan.

- 樓面平面圖之尺規所列數字為以毫米標示之建築結構尺寸，並以四捨五入至整數。
- 平面圖中顯示之名詞及簡稱之圖例請參閱本售樓說明書第22-23頁。

Area of Residential Properties 住宅物業的面積

Description of Residential Property 住宅物業的描述			Saleable Area (including balcony, utility platform and verandah, if any) sq. meter (sq. ft.) 實用面積 (包括露台, 工作平台及陽台 (如有)) 平方米 (平方呎)	Area of other specified items (Not included in the Saleable Area) 其他指明項目的面積 (不計算入實用面積) sq. metre (sq. ft.) 平方米 (平方呎)									
Tower 座	Floor 樓層	Unit 單位		Air-conditioning plant room 空調機房	Bay Window 窗台	Cockloft 閣樓	Flat roof 平台	Garden 花園	Parking space 停車位	Roof 天台	Stairhood 梯屋	Terrace 前庭	Yard 庭院
Tower 1 第1座	5/F 5樓	A	64.169 (691) 露台 Balcony: 0.000 (0) 工作平台 Utility Platform: 0.000 (0)	--	--	--	19.029 (205)	--	--	--	--	--	--
		B	31.306 (337) 露台 Balcony: 2.000 (22) 工作平台 Utility Platform: 0.000 (0)	--	--	--	--	--	--	--	--	--	--
		C	21.172 (228) 露台 Balcony: 2.000 (22) 工作平台 Utility Platform: 0.000 (0)	--	--	--	--	--	--	--	--	--	--
		D	42.945 (462) 露台 Balcony: 2.000 (22) 工作平台 Utility Platform: 1.500 (16)	--	--	--	--	--	--	--	--	--	--
		E	49.758 (536) 露台 Balcony: 0.000 (0) 工作平台 Utility Platform: 0.000 (0)	--	--	--	41.360 (445)	--	--	--	--	--	--
		F	28.779 (310) 露台 Balcony: 0.000 (0) 工作平台 Utility Platform: 0.000 (0)	--	--	--	9.632 (104)	--	--	--	--	--	--
		G	46.851 (504) 露台 Balcony: 0.000 (0) 工作平台 Utility Platform: 0.000 (0)	--	--	--	26.793 (288)	--	--	--	--	--	--
		H	49.303 (531) 露台 Balcony: 0.000 (0) 工作平台 Utility Platform: 0.000 (0)	--	--	--	37.258 (401)	--	--	--	--	--	--

The saleable area of each residential property and, the floor areas of balcony, utility platform and verandah (if any) are calculated in accordance with section 8 of the Residential Properties (First-hand Sales) Ordinance; and the areas of other specified items (not included in the saleable area) are calculated in accordance with Part 2 of Schedule 2 of the Residential Properties (First-hand Sales) Ordinance.

The area as specified above in square feet are converted at a rate of 1 square metre = 10.764 square feet and rounded off to the nearest whole square foot. Which may be slightly different from that shown in square metres. Residential floors 4/F, 13/F, 14/F, 24/F, 34/F and 44/F of Tower 1 are omitted. 25/F of Tower 1 is refuge floor.

每個住宅物業的實用面積、以及露台、工作平台及陽台（如有）之樓面面積，是按照《一手住宅物業銷售條例》第8條計算得出的。其他指明項目的面積（不計算入實用面積），是按照《一手住宅物業銷售條例》附表2第2部計算得出的。

上述以平方呎顯示之面積，均以1平方米=10.764平方呎換算，並以四捨五入至整數平方呎，平方呎與平方米顯示之面積可能有些微差異。

第1座住宅樓層不設4樓、13樓、14樓、24樓、34樓及44樓。第1座住宅25樓為庇護層。

Area of Residential Properties 住宅物業的面積

Description of Residential Property 住宅物業的描述			Saleable Area (including balcony, utility platform and verandah, if any) sq. meter (sq. ft.) 實用面積 (包括露台, 工作平台及陽台 (如有)) 平方米 (平方呎)	Area of other specified items (Not included in the Saleable Area) 其他指明項目的面積 (不計算入實用面積) sq. metre (sq. ft.) 平方米 (平方呎)										
Tower 座	Floor 樓層	Unit 單位		Air-conditioning plant room 空調機房	Bay Window 窗台	Cockloft 閣樓	Flat roof 平台	Garden 花園	Parking space 停車位	Roof 天台	Stairhood 梯屋	Terrace 前庭	Yard 庭院	
Tower 1 第1座	6/F - 12/F, 15/F - 23/F (13/F & 14/F are omitted) 6樓 - 12樓、 15樓 - 23樓 (不設13樓及 14樓)	A	67.953 (731) 露台 Balcony: 2.284 (25) 工作平台 Utility Platform: 1.500 (16)	--	--	--	--	--	--	--	--	--	--	
		B	31.306 (337) 露台 Balcony: 2.000 (22) 工作平台 Utility Platform: 0.000 (0)	--	--	--	--	--	--	--	--	--	--	--
		C	21.172(228) 露台 Balcony: 2.000 (22) 工作平台 Utility Platform: 0.000 (0)	--	--	--	--	--	--	--	--	--	--	--
		D	42.945 (462) 露台 Balcony: 2.000 (22) 工作平台 Utility Platform: 1.500 (16)	--	--	--	--	--	--	--	--	--	--	--
		E	53.258 (573) 露台 Balcony: 2.000 (22) 工作平台 Utility Platform: 1.500 (16)	--	--	--	--	--	--	--	--	--	--	--
		F	30.779 (331) 露台 Balcony: 2.000 (22) 工作平台 Utility Platform: 0.000 (0)	--	--	--	--	--	--	--	--	--	--	--
		G	50.351(542) 露台 Balcony: 2.000 (22) 工作平台 Utility Platform: 1.500 (16)	--	--	--	--	--	--	--	--	--	--	--
		H	52.803 (568) 露台 Balcony: 2.000 (22) 工作平台 Utility Platform: 1.500 (16)	--	--	--	--	--	--	--	--	--	--	--

The saleable area of each residential property and, the floor areas of balcony, utility platform and verandah (if any) are calculated in accordance with section 8 of the Residential Properties (First-hand Sales) Ordinance; and the areas of other specified items (not included in the saleable area) are calculated in accordance with Part 2 of Schedule 2 of the Residential Properties (First-hand Sales) Ordinance.

The area as specified above in square feet are converted at a rate of 1 square metre = 10.764 square feet and rounded off to the nearest whole square foot. Which may be slightly different from that shown in square metres. Residential floors 4/F, 13/F, 14/F, 24/F, 34/F and 44/F of Tower 1 are omitted. 25/F of Tower 1 is refuge floor.

每個住宅物業的實用面積、以及露台、工作平台及陽台(如有)之樓面面積, 是按照《一手住宅物業銷售條例》第8條計算得出的。其他指明項目的面積(不計算入實用面積), 是按照《一手住宅物業銷售條例》附表2第2部計算得出的。

上述以平方呎顯示之面積, 均以1平方米=10.764平方呎換算, 並以四捨五入至整數平方呎, 平方呎與平方米顯示之面積可能有些微差異。

第1座住宅樓層不設4樓、13樓、14樓、24樓、34樓及44樓。第1座住宅25樓為庇護層。

Area of Residential Properties 住宅物業的面積

Description of Residential Property 住宅物業的描述			Saleable Area (including balcony, utility platform and verandah, if any) sq. meter (sq. ft.) 實用面積 (包括露台, 工作平台及陽台 (如有)) 平方米 (平方呎)	Area of other specified items (Not included in the Saleable Area) 其他指明項目的面積 (不計算入實用面積) sq. metre (sq. ft.) 平方米 (平方呎)										
Tower 座	Floor 樓層	Unit 單位		Air-conditioning plant room 空調機房	Bay Window 窗台	Cockloft 閣樓	Flat roof 平台	Garden 花園	Parking space 停車位	Roof 天台	Stairhood 梯屋	Terrace 前庭	Yard 庭院	
Tower 1 第1座	26/F - 33/F 35/F - 43/F 45/F - 48/F (34/F & 44/F are omitted) 26樓 - 33樓 35樓 - 43樓 45樓 - 48樓 (不設34樓及 44樓)	A	67.953 (731) 露台 Balcony: 2.284 (25) 工作平台 Utility Platform: 1.500 (16)	--	--	--	--	--	--	--	--	--	--	
		B	31.306 (337) 露台 Balcony: 2.000 (22) 工作平台 Utility Platform: 0.000 (0)	--	--	--	--	--	--	--	--	--	--	--
		C	21.172(228) 露台 Balcony: 2.000 (22) 工作平台 Utility Platform: 0.000 (0)	--	--	--	--	--	--	--	--	--	--	--
		D	42.945 (462) 露台 Balcony: 2.000 (22) 工作平台 Utility Platform: 1.500 (16)	--	--	--	--	--	--	--	--	--	--	--
		E	53.258 (573) 露台 Balcony: 2.000 (22) 工作平台 Utility Platform: 1.500 (16)	--	--	--	--	--	--	--	--	--	--	--
		F	30.779 (331) 露台 Balcony: 2.000 (22) 工作平台 Utility Platform: 0.000 (0)	--	--	--	--	--	--	--	--	--	--	--
		G	50.351(542) 露台 Balcony: 2.000 (22) 工作平台 Utility Platform: 1.500 (16)	--	--	--	--	--	--	--	--	--	--	--
		H	52.803 (568) 露台 Balcony: 2.000 (22) 工作平台 Utility Platform: 1.500 (16)	--	--	--	--	--	--	--	--	--	--	--

The saleable area of each residential property and, the floor areas of balcony, utility platform and verandah (if any) are calculated in accordance with section 8 of the Residential Properties (First-hand Sales) Ordinance; and the areas of other specified items (not included in the saleable area) are calculated in accordance with Part 2 of Schedule 2 of the Residential Properties (First-hand Sales) Ordinance.

The area as specified above in square feet are converted at a rate of 1 square metre = 10.764 square feet and rounded off to the nearest whole square foot. Which may be slightly different from that shown in square metres. Residential floors 4/F, 13/F, 14/F, 24/F, 34/F and 44/F of Tower 1 are omitted. 25/F of Tower 1 is refuge floor.

每個住宅物業的實用面積、以及露台、工作平台及陽台(如有)之樓面面積, 是按照《一手住宅物業銷售條例》第8條計算得出的。其他指明項目的面積(不計算入實用面積), 是按照《一手住宅物業銷售條例》附表2第2部計算得出的。

上述以平方呎顯示之面積, 均以1平方米=10.764平方呎換算, 並以四捨五入至整數平方呎, 平方呎與平方米顯示之面積可能有些微差異。

第1座住宅樓層不設4樓、13樓、14樓、24樓、34樓及44樓。第1座住宅25樓為庇護層。

Area of Residential Properties 住宅物業的面積

Description of Residential Property 住宅物業的描述			Saleable Area (including balcony, utility platform and verandah, if any) sq. meter (sq. ft.) 實用面積 (包括露台, 工作平台及陽台 (如有)) 平方米 (平方呎)	Area of other specified items (Not included in the Saleable Area) 其他指明項目的面積 (不計算入實用面積) sq. metre (sq. ft.) 平方米 (平方呎)									
Tower 座	Floor 樓層	Unit 單位		Air-conditioning plant room 空調機房	Bay Window 窗台	Cockloft 閣樓	Flat roof 平台	Garden 花園	Parking space 停車位	Roof 天台	Stairhood 梯屋	Terrace 前庭	Yard 庭院
Tower 1 第1座	49/F 49樓	A	113.043 (1,217) 露台 Balcony: 4.315 (46) 工作平台 Utility Platform: 0.000 (0)	--	--	--	8.083 (87)	--	--	78.103 (841)	4.476 (48)	--	--
		B	102.596 (1,104) 露台 Balcony: 2.000 (22) 工作平台 Utility Platform: 1.500 (16)	--	--	--	6.900 (74)	--	--	56.808 (611)	5.456 (59)	--	--
		C	99.588 (1,072) 露台 Balcony: 2.000 (22) 工作平台 Utility Platform: 0.000 (0)	--	--	--	11.333 (122)	--	--	70.196 (756)	2.419 (26)	--	--

The saleable area of each residential property and, the floor areas of balcony, utility platform and verandah (if any) are calculated in accordance with section 8 of the Residential Properties (First-hand Sales) Ordinance; and the areas of other specified items (not included in the saleable area) are calculated in accordance with Part 2 of Schedule 2 of the Residential Properties (First-hand Sales) Ordinance.

The area as specified above in square feet are converted at a rate of 1 square metre = 10.764 square feet and rounded off to the nearest whole square foot. Which may be slightly different from that shown in square metres. Residential floors 4/F, 13/F, 14/F, 24/F, 34/F and 44/F of Tower 1 are omitted. 25/F of Tower 1 is refuge floor.

每個住宅物業的實用面積、以及露台、工作平台及陽台 (如有) 之樓面面積, 是按照《一手住宅物業銷售條例》第8條計算得出的。其他指明項目的面積 (不計算入實用面積), 是按照《一手住宅物業銷售條例》附表2第2部計算得出的。

上述以平方呎顯示之面積, 均以1平方米=10.764平方呎換算, 並以四捨五入至整數平方呎, 平方呎與平方米顯示之面積可能有些微差異。
第1座住宅樓層不設4樓、13樓、14樓、24樓、34樓及44樓。第1座住宅25樓為庇護層。

Area of Residential Properties 住宅物業的面積

Description of Residential Property 住宅物業的描述			Saleable Area (including balcony, utility platform and verandah, if any) sq. meter (sq. ft.) 實用面積 (包括露台, 工作平台及陽台 (如有)) 平方米 (平方呎)	Area of other specified items (Not included in the Saleable Area) 其他指明項目的面積 (不計算入實用面積) sq. metre (sq. ft.) 平方米 (平方呎)									
Tower 座	Floor 樓層	Unit 單位		Air-conditioning plant room 空調機房	Bay Window 窗台	Cockloft 閣樓	Flat roof 平台	Garden 花園	Parking space 停車位	Roof 天台	Stairhood 梯屋	Terrace 前庭	Yard 庭院
Tower 2 第2座	5/F 5樓	A	28.181 (303) 露台 Balcony: 0.000 (0) 工作平台 Utility Platform: 0.000 (0)	--	--	--	9.445 (102)	--	--	--	--	--	--
		B	41.223(444) 露台 Balcony: 0.000 (0) 工作平台 Utility Platform: 0.000 (0)	--	--	--	17.222 (185)	--	--	--	--	--	--
		C	74.800 (805) 露台 Balcony: 0.000 (0) 工作平台 Utility Platform: 0.000 (0)	--	--	--	29.647 (319)	--	--	--	--	--	--
		D	50.555 (544) 露台 Balcony: 0.000 (0) 工作平台 Utility Platform: 0.000 (0)	--	--	--	13.177 (142)	--	--	--	--	--	--
		E	32.228 (347) 露台 Balcony: 0.000 (0) 工作平台 Utility Platform: 0.000 (0)	--	--	--	21.282 (229)	--	--	--	--	--	--
		F	68.448 (737) 露台 Balcony: 0.000 (0) 工作平台 Utility Platform: 0.000 (0)	--	--	--	19.766 (213)	--	--	--	--	--	--
		G	50.708 (546) 露台 Balcony: 0.000 (0) 工作平台 Utility Platform: 0.000 (0)	--	--	--	8.019 (86)	--	--	--	--	--	--
		H	22.060 (237) 露台 Balcony: 0.000 (0) 工作平台 Utility Platform: 0.000 (0)	--	--	--	8.033 (86)	--	--	--	--	--	--

The saleable area of each residential property and, the floor areas of balcony, utility platform and verandah (if any) are calculated in accordance with section 8 of the Residential Properties (First-hand Sales) Ordinance; and the areas of other specified items (not included in the saleable area) are calculated in accordance with Part 2 of Schedule 2 of the Residential Properties (First-hand Sales) Ordinance.

The area as specified above in square feet are converted at a rate of 1 square metre = 10.764 square feet and rounded off to the nearest whole square foot. Which may be slightly different from that shown in square metres. Residential floors 4/F, 13/F, 14/F, 24/F, 34/F and 44/F of Tower 2 are omitted. 25/F of Tower 2 is refuge floor.

每個住宅物業的實用面積、以及露台、工作平台及陽台（如有）之樓面面積，是按照《一手住宅物業銷售條例》第8條計算得出的。其他指明項目的面積（不計算入實用面積），是按照《一手住宅物業銷售條例》附表2第2部計算得出的。

上述以平方呎顯示之面積，均以1平方米=10.764平方呎換算，並以四捨五入至整數平方呎，平方呎與平方米顯示之面積可能有些微差異。
第2座住宅樓層不設4樓、13樓、14樓、24樓、34樓及44樓。第2座住宅25樓為庇護層。

Area of Residential Properties 住宅物業的面積

Description of Residential Property 住宅物業的描述			Saleable Area (including balcony, utility platform and verandah, if any) sq. meter (sq. ft.) 實用面積 (包括露台, 工作平台及陽台 (如有)) 平方米 (平方呎)	Area of other specified items (Not included in the Saleable Area) 其他指明項目的面積 (不計算入實用面積) sq. metre (sq. ft.) 平方米 (平方呎)										
Tower 座	Floor 樓層	Unit 單位		Air-conditioning plant room 空調機房	Bay Window 窗台	Cockloft 閣樓	Flat roof 平台	Garden 花園	Parking space 停車位	Roof 天台	Stairhood 梯屋	Terrace 前庭	Yard 庭院	
Tower 2 第2座	6/F - 12/F, 15/F - 23/F, 26/F - 33/F, 35/F - 43/F & 45/F - 47/F (13/F, 14/F, 24/F, 34/F & 44/F are omitted) 6樓 - 12樓、 15樓 - 23樓、 26樓 - 33樓、 35樓 - 43樓及 45樓 - 47樓 (不設13樓、 14樓、24樓、 34樓及44樓)	A	30.181 (325) 露台 Balcony: 2.000 (22) 工作平台 Utility Platform: 0.000 (0)	--	--	--	--	--	--	--	--	--	--	
		B	44.723(481) 露台 Balcony: 2.000 (22) 工作平台 Utility Platform: 1.500 (16)	--	--	--	--	--	--	--	--	--	--	--
		C	78.932 (850) 露台 Balcony: 2.632 (28) 工作平台 Utility Platform: 1.500 (16)	--	--	--	--	--	--	--	--	--	--	--
		D	54.055 (582) 露台 Balcony: 2.000 (22) 工作平台 Utility Platform: 1.500 (16)	--	--	--	--	--	--	--	--	--	--	--
		E	35.728 (385) 露台 Balcony: 2.000 (22) 工作平台 Utility Platform: 1.500 (16)	--	--	--	--	--	--	--	--	--	--	--
		F	71.948 (774) 露台 Balcony: 2.000 (22) 工作平台 Utility Platform: 1.500 (16)	--	--	--	--	--	--	--	--	--	--	--
		G	54.208 (583) 露台 Balcony: 2.000 (22) 工作平台 Utility Platform: 1.500 (16)	--	--	--	--	--	--	--	--	--	--	--
		H	24.060 (259) 露台 Balcony: 2.000 (22) 工作平台 Utility Platform: 0.000 (0)	--	--	--	--	--	--	--	--	--	--	--

The saleable area of each residential property and, the floor areas of balcony, utility platform and verandah (if any) are calculated in accordance with section 8 of the Residential Properties (First-hand Sales) Ordinance; and the areas of other specified items (not included in the saleable area) are calculated in accordance with Part 2 of Schedule 2 of the Residential Properties (First-hand Sales) Ordinance.

The area as specified above in square feet are converted at a rate of 1 square metre = 10.764 square feet and rounded off to the nearest whole square foot. Which may be slightly different from that shown in square metres. Residential floors 4/F, 13/F, 14/F, 24/F, 34/F and 44/F of Tower 2 are omitted. 25/F of Tower 2 is refuge floor.

每個住宅物業的實用面積、以及露台、工作平台及陽台(如有)之樓面面積, 是按照《一手住宅物業銷售條例》第8條計算得出的。其他指明項目的面積(不計算入實用面積), 是按照《一手住宅物業銷售條例》附表2第2部計算得出的。

上述以平方呎顯示之面積, 均以1平方米=10.764平方呎換算, 並以四捨五入至整數平方呎, 平方呎與平方米顯示之面積可能有些微差異。
第2座住宅樓層不設4樓、13樓、14樓、24樓、34樓及44樓。第2座住宅25樓為庇護層。

Area of Residential Properties 住宅物業的面積

Description of Residential Property 住宅物業的描述			Saleable Area (including balcony, utility platform and verandah, if any) sq. meter (sq. ft.) 實用面積 (包括露台, 工作平台及陽台 (如有)) 平方米 (平方呎)	Area of other specified items (Not included in the Saleable Area) 其他指明項目的面積 (不計算入實用面積) sq. metre (sq. ft.) 平方米 (平方呎)										
Tower 座	Floor 樓層	Unit 單位		Air-conditioning plant room 空調機房	Bay Window 窗台	Cockloft 閣樓	Flat roof 平台	Garden 花園	Parking space 停車位	Roof 天台	Stairhood 梯屋	Terrace 前庭	Yard 庭院	
Tower 2 第2座	48/F 48樓	A	30.181 (325) 露台 Balcony: 2.000 (22) 工作平台 Utility Platform: 0.000 (0)	--	--	--	--	--	--	--	--	--	--	
		B	44.723(481) 露台 Balcony: 2.000 (22) 工作平台 Utility Platform: 1.500 (16)	--	--	--	--	--	--	--	--	--	--	--
		C	78.932 (850) 露台 Balcony: 2.632 (28) 工作平台 Utility Platform: 1.500 (16)	--	--	--	--	--	--	--	--	--	--	--
		D	54.055 (582) 露台 Balcony: 2.000 (22) 工作平台 Utility Platform: 1.500 (16)	--	--	--	--	--	--	43.023 (463)	--	--	--	--
		E	35.728 (385) 露台 Balcony: 2.000 (22) 工作平台 Utility Platform: 1.500 (16)	--	--	--	--	--	--	25.681 (276)	--	--	--	--
		F	71.948 (774) 露台 Balcony: 2.000 (22) 工作平台 Utility Platform: 1.500 (16)	--	--	--	--	--	--	--	--	--	--	--
		G	54.208 (583) 露台 Balcony: 2.000 (22) 工作平台 Utility Platform: 1.500 (16)	--	--	--	--	--	--	--	--	--	--	--
		H	24.060 (259) 露台 Balcony: 2.000 (22) 工作平台 Utility Platform: 0.000 (0)	--	--	--	--	--	--	--	--	--	--	--
	49/F 49樓	A	157.191 (1,692) 露台 Balcony: 0.000 (0) 工作平台 Utility Platform: 1.500 (16)	--	--	--	4.328 (47)	--	--	111.380 (1,199)	4.945 (53)	--	--	--
		B	139.806 (1,505) 露台 Balcony: 2.000 (22) 工作平台 Utility Platform: 1.500 (16)	--	--	--	5.823 (63)	--	--	105.370 (1,134)	5.139 (55)	--	--	--

The saleable area of each residential property and, the floor areas of balcony, utility platform and verandah (if any) are calculated in accordance with section 8 of the Residential Properties (First-hand Sales) Ordinance; and the areas of other specified items (not included in the saleable area) are calculated in accordance with Part 2 of Schedule 2 of the Residential Properties (First-hand Sales) Ordinance.

The area as specified above in square feet are converted at a rate of 1 square metre = 10.764 square feet and rounded off to the nearest whole square foot. Which may be slightly different from that shown in square metres. Residential floors 4/F, 13/F, 14/F, 24/F, 34/F and 44/F of Tower 2 are omitted. 25/F of Tower 2 is refuge floor.

每個住宅物業的實用面積、以及露台、工作平台及陽台（如有）之樓面面積，是按照《一手住宅物業銷售條例》第8條計算得出的。其他指明項目的面積（不計算入實用面積），是按照《一手住宅物業銷售條例》附表2第2部計算得出的。

上述以平方呎顯示之面積，均以1平方米=10.764平方呎換算，並以四捨五入至整數平方呎，平方呎與平方米顯示之面積可能有些微差異。

第2座住宅樓層不設4樓、13樓、14樓、24樓、34樓及44樓。第2座住宅25樓為庇護層。

Area of Residential Properties 住宅物業的面積

Description of Residential Property 住宅物業的描述			Saleable Area (including balcony, utility platform and verandah, if any) sq. meter (sq. ft.) 實用面積 (包括露台, 工作平台及陽台 (如有)) 平方米 (平方呎)	Area of other specified items (Not included in the Saleable Area) 其他指明項目的面積 (不計算入實用面積) sq. metre (sq. ft.) 平方米 (平方呎)									
Tower 座	Floor 樓層	Unit 單位		Air-conditioning plant room 空調機房	Bay Window 窗台	Cockloft 閣樓	Flat roof 平台	Garden 花園	Parking space 停車位	Roof 天台	Stairhood 梯屋	Terrace 前庭	Yard 庭院
Tower 3 第3座	5/F 5樓	A	58.837 (633) 露台 Balcony: 0.000 (0) 工作平台 Utility Platform: 0.000 (0)	--	--	--	25.369 (273)	--	--	--	--	--	--
		B	44.104 (475) 露台 Balcony: 0.000 (0) 工作平台 Utility Platform: 0.000 (0)	--	--	--	4.696 (51)	--	--	--	--	--	--
		C	84.723 (912) 露台 Balcony: 0.000 (0) 工作平台 Utility Platform: 1.500 (16)	--	--	--	6.188 (67)	--	--	--	--	--	--
		D	58.087 (625) 露台 Balcony: 0.000 (0) 工作平台 Utility Platform: 0.000 (0)	--	--	--	20.476 (220)	--	--	--	--	--	--
		E	28.785 (310) 露台 Balcony: 0.000 (0) 工作平台 Utility Platform: 0.000 (0)	--	--	--	10.092 (109)	--	--	--	--	--	--
		F	28.684 (309) 露台 Balcony: 0.000 (0) 工作平台 Utility Platform: 0.000 (0)	--	--	--	11.286 (121)	--	--	--	--	--	--
		G	28.732 (309) 露台 Balcony: 0.000 (0) 工作平台 Utility Platform: 0.000 (0)	--	--	--	13.871 (149)	--	--	--	--	--	--
		H	66.251 (713) 露台 Balcony: 0.000 (0) 工作平台 Utility Platform: 0.000 (0)	--	--	--	41.619 (448)	--	--	--	--	--	--
		J	47.808 (515) 露台 Balcony: 0.000 (0) 工作平台 Utility Platform: 0.000 (0)	--	--	--	20.235 (218)	--	--	--	--	--	--

The saleable area of each residential property and, the floor areas of balcony, utility platform and verandah (if any) are calculated in accordance with section 8 of the Residential Properties (First-hand Sales) Ordinance; and the areas of other specified items (not included in the saleable area) are calculated in accordance with Part 2 of Schedule 2 of the Residential Properties (First-hand Sales) Ordinance.

The area as specified above in square feet are converted at a rate of 1 square metre = 10.764 square feet and rounded off to the nearest whole square foot. Which may be slightly different from that shown in square metres. Residential floors 4/F, 13/F, 14/F, 24/F, 34/F and 44/F of Tower 3 are omitted. 25/F of Tower 3 is refuge floor.

每個住宅物業的實用面積、以及露台、工作平台及陽台(如有)之樓面面積, 是按照《一手住宅物業銷售條例》第8條計算得出的。其他指明項目的面積(不計算入實用面積), 是按照《一手住宅物業銷售條例》附表2第2部計算得出的。

上述以平方呎顯示之面積, 均以1平方米=10.764平方呎換算, 並以四捨五入至整數平方呎, 平方呎與平方米顯示之面積可能有些微差異。

第3座住宅樓層不設4樓、13樓、14樓、24樓、34樓及44樓。第3座住宅25樓為庇護層。

Area of Residential Properties 住宅物業的面積

Description of Residential Property 住宅物業的描述			Saleable Area (including balcony, utility platform and verandah, if any) sq. meter (sq. ft.) 實用面積 (包括露台, 工作平台及陽台 (如有)) 平方米 (平方呎)	Area of other specified items (Not included in the Saleable Area) 其他指明項目的面積 (不計算入實用面積) sq. metre (sq. ft.) 平方米 (平方呎)										
Tower 座	Floor 樓層	Unit 單位		Air-conditioning plant room 空調機房	Bay Window 窗台	Cockloft 閣樓	Flat roof 平台	Garden 花園	Parking space 停車位	Roof 天台	Stairhood 梯屋	Terrace 前庭	Yard 庭院	
Tower 3 第3座	6/F - 12/F, 15/F - 23/F (13/F & 14/F are omitted) 6樓 - 12樓、 15樓 - 23樓 (不設13樓及 14樓)	A	62.541 (673) 露台 Balcony: 2.204 (24) 工作平台 Utility Platform: 1.500 (16)	--	--	--	--	--	--	--	--	--	--	
		B	47.604 (512) 露台 Balcony: 2.000 (22) 工作平台 Utility Platform: 1.500 (16)	--	--	--	--	--	--	--	--	--	--	--
		C	87.828 (945) 露台 Balcony: 3.105 (33) 工作平台 Utility Platform: 1.500 (16)	--	--	--	--	--	--	--	--	--	--	--
		D	62.862 (677) 露台 Balcony: 3.275 (35) 工作平台 Utility Platform: 1.500 (16)	--	--	--	--	--	--	--	--	--	--	--
		E	32.285 (348) 露台 Balcony: 2.000 (22) 工作平台 Utility Platform: 1.500 (16)	--	--	--	--	--	--	--	--	--	--	--
		F	32.184 (346) 露台 Balcony: 2.000 (22) 工作平台 Utility Platform: 1.500 (16)	--	--	--	--	--	--	--	--	--	--	--
		G	32.232 (347) 露台 Balcony: 2.000 (22) 工作平台 Utility Platform: 1.500 (16)	--	--	--	--	--	--	--	--	--	--	--
		H	70.173 (755) 露台 Balcony: 2.422 (26) 工作平台 Utility Platform: 1.500 (16)	--	--	--	--	--	--	--	--	--	--	--
		J	51.308 (552) 露台 Balcony: 2.000 (22) 工作平台 Utility Platform: 1.500 (16)	--	--	--	--	--	--	--	--	--	--	--

The saleable area of each residential property and, the floor areas of balcony, utility platform and verandah (if any) are calculated in accordance with section 8 of the Residential Properties (First-hand Sales) Ordinance; and the areas of other specified items (not included in the saleable area) are calculated in accordance with Part 2 of Schedule 2 of the Residential Properties (First-hand Sales) Ordinance.

The area as specified above in square feet are converted at a rate of 1 square metre = 10.764 square feet and rounded off to the nearest whole square foot. Which may be slightly different from that shown in square metres. Residential floors 4/F, 13/F, 14/F, 24/F, 34/F and 44/F of Tower 3 are omitted. 25/F of Tower 3 is refuge floor.

每個住宅物業的實用面積、以及露台、工作平台及陽台(如有)之樓面面積, 是按照《一手住宅物業銷售條例》第8條計算得出的。其他指明項目的面積(不計算入實用面積), 是按照《一手住宅物業銷售條例》附表2第2部計算得出的。

上述以平方呎顯示之面積, 均以1平方米=10.764平方呎換算, 並以四捨五入至整數平方呎, 平方呎與平方米顯示之面積可能有些微差異。

第3座住宅樓層不設4樓、13樓、14樓、24樓、34樓及44樓。第3座住宅25樓為庇護層。

Area of Residential Properties 住宅物業的面積

Description of Residential Property 住宅物業的描述			Saleable Area (including balcony, utility platform and verandah, if any) sq. meter (sq. ft.) 實用面積 (包括露台, 工作平台及陽台 (如有)) 平方米 (平方呎)	Area of other specified items (Not included in the Saleable Area) 其他指明項目的面積 (不計算入實用面積) sq. metre (sq. ft.) 平方米 (平方呎)										
Tower 座	Floor 樓層	Unit 單位		Air-conditioning plant room 空調機房	Bay Window 窗台	Cockloft 閣樓	Flat roof 平台	Garden 花園	Parking space 停車位	Roof 天台	Stairhood 梯屋	Terrace 前庭	Yard 庭院	
Tower 3 第3座	26/F - 33/F, 35/F - 43/F, 45/F - 49/F (34/F & 44/F are omitted) 26樓 - 33樓、 35樓 - 43樓、 45樓 - 49樓 (不設34樓及 44樓)	A	62.541 (673) 露台 Balcony: 2.204 (24) 工作平台 Utility Platform: 1.500 (16)	--	--	--	--	--	--	--	--	--	--	
		B	47.604 (512) 露台 Balcony: 2.000 (22) 工作平台 Utility Platform: 1.500 (16)	--	--	--	--	--	--	--	--	--	--	--
		C	87.828 (945) 露台 Balcony: 3.105 (33) 工作平台 Utility Platform: 1.500 (16)	--	--	--	--	--	--	--	--	--	--	--
		D	62.862 (677) 露台 Balcony: 3.275 (35) 工作平台 Utility Platform: 1.500 (16)	--	--	--	--	--	--	--	--	--	--	--
		E	32.285 (348) 露台 Balcony: 2.000 (22) 工作平台 Utility Platform: 1.500 (16)	--	--	--	--	--	--	--	--	--	--	--
		F	32.184 (346) 露台 Balcony: 2.000 (22) 工作平台 Utility Platform: 1.500 (16)	--	--	--	--	--	--	--	--	--	--	--
		G	32.232 (347) 露台 Balcony: 2.000 (22) 工作平台 Utility Platform: 1.500 (16)	--	--	--	--	--	--	--	--	--	--	--
		H	70.108 (755) 露台 Balcony: 2.422 (26) 工作平台 Utility Platform: 1.500 (16)	--	--	--	--	--	--	--	--	--	--	--
		J	51.308 (552) 露台 Balcony: 2.000 (22) 工作平台 Utility Platform: 1.500 (16)	--	--	--	--	--	--	--	--	--	--	--

The saleable area of each residential property and, the floor areas of balcony, utility platform and verandah (if any) are calculated in accordance with section 8 of the Residential Properties (First-hand Sales) Ordinance; and the areas of other specified items (not included in the saleable area) are calculated in accordance with Part 2 of Schedule 2 of the Residential Properties (First-hand Sales) Ordinance.

The area as specified above in square feet are converted at a rate of 1 square metre = 10.764 square feet and rounded off to the nearest whole square foot. Which may be slightly different from that shown in square metres. Residential floors 4/F, 13/F, 14/F, 24/F, 34/F and 44/F of Tower 3 are omitted. 25/F of Tower 3 is refuge floor.

每個住宅物業的實用面積、以及露台、工作平台及陽台 (如有) 之樓面面積, 是按照《一手住宅物業銷售條例》第8條計算得出的。其他指明項目的面積 (不計算入實用面積), 是按照《一手住宅物業銷售條例》附表2第2部計算得出的。

上述以平方呎顯示之面積, 均以1平方米=10.764平方呎換算, 並以四捨五入至整數平方呎, 平方呎與平方米顯示之面積可能有些微差異。

第3座住宅樓層不設4樓、13樓、14樓、24樓、34樓及44樓。第3座住宅25樓為庇護層。

Area of Residential Properties 住宅物業的面積

Description of Residential Property 住宅物業的描述			Saleable Area (including balcony, utility platform and verandah, if any) sq. meter (sq. ft.) 實用面積 (包括露台, 工作平台及陽台 (如有)) 平方米 (平方呎)	Area of other specified items (Not included in the Saleable Area) 其他指明項目的面積 (不計算入實用面積) sq. metre (sq. ft.) 平方米 (平方呎)									
Tower 座	Floor 樓層	Unit 單位		Air-conditioning plant room 空調機房	Bay Window 窗台	Cockloft 閣樓	Flat roof 平台	Garden 花園	Parking space 停車位	Roof 天台	Stairhood 梯屋	Terrace 前庭	Yard 庭院
Tower 3 第3座	50/F 50樓	C	86.851 (935) 露台 Balcony: 3.275 (35) 工作平台 Utility Platform: 1.500 (16)	--	--	--	3.601 (39)	--	--	--	--	--	--
		D	32.402 (349) 露台 Balcony: 2.000 (22) 工作平台 Utility Platform: 1.500 (16)	--	--	--	--	--	--	--	--	--	--
		E	98.764 (1,063) 露台 Balcony: 2.422 (26) 工作平台 Utility Platform: 2.000 (22)	--	--	--	--	--	--	--	--	--	--
		F	51.308 (552) 露台 Balcony: 2.000 (22) 工作平台 Utility Platform: 1.500 (16)	--	--	--	--	--	--	--	--	--	--
	51/F 51樓	C	86.795 (934) 露台 Balcony: 3.275 (35) 工作平台 Utility Platform: 1.500 (16)	--	--	--	--	--	--	63.157 (680)	--	--	--
		D	32.402 (349) 露台 Balcony: 2.000 (22) 工作平台 Utility Platform: 1.500 (16)	--	--	--	--	--	--	11.480 (124)	--	--	--
		E	98.764 (1,063) 露台 Balcony: 2.422 (26) 工作平台 Utility Platform: 2.000 (22)	--	--	--	--	--	--	68.947 (742)	--	--	--
		F	51.308 (552) 露台 Balcony: 2.000 (22) 工作平台 Utility Platform: 1.500 (16)	--	--	--	--	--	--	45.924 (494)	--	--	--
	50/F & 51/F (Duplex) 50樓及51樓 (複式)	A	183.799 (1,978) 露台 Balcony: 0.000 (0) 工作平台 Utility Platform: 0.000 (0)	--	--	--	10.153 (109)	--	--	71.952 (774)	6.063 (65)	--	--
		B	152.837 (1,645) 露台 Balcony: 2.000 (22) 工作平台 Utility Platform: 0.000 (0)	--	--	--	7.954 (86)	--	--	61.402 (661)	5.940 (64)	--	--

The saleable area of each residential property and, the floor areas of balcony, utility platform and verandah (if any) are calculated in accordance with section 8 of the Residential Properties (First-hand Sales) Ordinance; and the areas of other specified items (not included in the saleable area) are calculated in accordance with Part 2 of Schedule 2 of the Residential Properties (First-hand Sales) Ordinance.

The area as specified above in square feet are converted at a rate of 1 square metre = 10.764 square feet and rounded off to the nearest whole square foot. Which may be slightly different from that shown in square metres. Residential floors 4/F, 13/F, 14/F, 24/F, 34/F and 44/F of Tower 3 are omitted. 25/F of Tower 3 is refuge floor.

每個住宅物業的實用面積、以及露台、工作平台及陽台(如有)之樓面面積,是按照《一手住宅物業銷售條例》第8條計算得出的。其他指明項目的面積(不計算入實用面積),是按照《一手住宅物業銷售條例》附表2第2部計算得出的。

上述以平方呎顯示之面積,均以1平方米=10.764平方呎換算,並以四捨五入至整數平方呎,平方呎與平方米顯示之面積可能有些微差異。

第3座住宅樓層不設4樓、13樓、14樓、24樓、34樓及44樓。第3座住宅25樓為庇護層。

Area of Residential Properties 住宅物業的面積

Description of Residential Property 住宅物業的描述			Saleable Area (including balcony, utility platform and verandah, if any) sq. meter (sq. ft.) 實用面積 (包括露台, 工作平台及陽台 (如有)) 平方米 (平方呎)	Area of other specified items (Not included in the Saleable Area) 其他指明項目的面積 (不計算入實用面積) sq. metre (sq. ft.) 平方米 (平方呎)									
Tower 座	Floor 樓層	Unit 單位		Air-conditioning plant room 空調機房	Bay Window 窗台	Cockloft 閣樓	Flat roof 平台	Garden 花園	Parking space 停車位	Roof 天台	Stairhood 梯屋	Terrace 前庭	Yard 庭院
Tower 5 第5座	5/F 5樓	A	58.837 (633) 露台 Balcony: 0.000 (0) 工作平台 Utility Platform: 0.000 (0)	--	--	--	27.776 (299)	--	--	--	--	--	--
		B	44.174 (475) 露台 Balcony: 0.000 (0) 工作平台 Utility Platform: 0.000 (0)	--	--	--	10.320 (111)	--	--	--	--	--	--
		C	84.832 (913) 露台 Balcony: 0.000 (0) 工作平台 Utility Platform: 1.500 (16)	--	--	--	23.224 (250)	--	--	--	--	--	--
		D	59.587 (641) 露台 Balcony: 0.000 (0) 工作平台 Utility Platform: 1.500 (16)	--	--	--	2.877 (31)	--	--	--	--	--	--
		E	28.785 (310) 露台 Balcony: 0.000 (0) 工作平台 Utility Platform: 0.000 (0)	--	--	--	10.726 (115)	--	--	--	--	--	--
		F	28.683 (309) 露台 Balcony: 0.000 (0) 工作平台 Utility Platform: 0.000 (0)	--	--	--	13.294 (143)	--	--	--	--	--	--
		G	28.733 (309) 露台 Balcony: 0.000 (0) 工作平台 Utility Platform: 0.000 (0)	--	--	--	13.281 (143)	--	--	--	--	--	--
		H	45.555 (490) 露台 Balcony: 0.000 (0) 工作平台 Utility Platform: 0.000 (0)	--	--	--	3.975 (43)	--	--	--	--	--	--
		J	47.800 (515) 露台 Balcony: 0.000 (0) 工作平台 Utility Platform: 0.000 (0)	--	--	--	12.152 (131)	--	--	--	--	--	--

The saleable area of each residential property and, the floor areas of balcony, utility platform and verandah (if any) are calculated in accordance with section 8 of the Residential Properties (First-hand Sales) Ordinance; and the areas of other specified items (not included in the saleable area) are calculated in accordance with Part 2 of Schedule 2 of the Residential Properties (First-hand Sales) Ordinance.

The area as specified above in square feet are converted at a rate of 1 square metre = 10.764 square feet and rounded off to the nearest whole square foot. Which may be slightly different from that shown in square metres. Residential floors 4/F, 13/F, 14/F, 24/F, 34/F and 44/F of Tower 5 are omitted. 25/F of Tower 5 is refuge floor.

每個住宅物業的實用面積、以及露台、工作平台及陽台(如有)之樓面面積, 是按照《一手住宅物業銷售條例》第8條計算得出的。其他指明項目的面積(不計算入實用面積), 是按照《一手住宅物業銷售條例》附表2第2部計算得出的。

上述以平方呎顯示之面積, 均以1平方米=10.764平方呎換算, 並以四捨五入至整數平方呎, 平方呎與平方米顯示之面積可能有些微差異。

第5座住宅樓層不設4樓、13樓、14樓、24樓、34樓及44樓。第5座住宅25樓為庇護層。

Area of Residential Properties 住宅物業的面積

Description of Residential Property 住宅物業的描述			Saleable Area (including balcony, utility platform and verandah, if any) sq. meter (sq. ft.) 實用面積 (包括露台, 工作平台及陽台 (如有)) 平方米 (平方呎)	Area of other specified items (Not included in the Saleable Area) 其他指明項目的面積 (不計算入實用面積) sq. metre (sq. ft.) 平方米 (平方呎)											
Tower 座	Floor 樓層	Unit 單位		Air-conditioning plant room 空調機房	Bay Window 窗台	Cockloft 閣樓	Flat roof 平台	Garden 花園	Parking space 停車位	Roof 天台	Stairhood 梯屋	Terrace 前庭	Yard 庭院		
Tower 5 第5座	6/F - 12/F, 15/F - 23/F (13/F & 14/F are omitted) 6樓 - 12樓、 15樓 - 23樓 (不設13樓及 14樓)	A	62.541 (673) 露台 Balcony: 2.204 (24) 工作平台 Utility Platform: 1.500 (16)	--	--	--	--	--	--	--	--	--	--		
		B	45.674 (492) 露台 Balcony: 0.000 (0) 工作平台 Utility Platform: 1.500 (16)	--	--	--	--	--	--	--	--	--	--	--	
		C	87.937 (947) 露台 Balcony: 3.105 (33) 工作平台 Utility Platform: 1.500 (16)	--	--	--	--	--	--	--	--	--	--	--	
		D	62.862 (677) 露台 Balcony: 3.275 (35) 工作平台 Utility Platform: 1.500 (16)	--	--	--	--	--	--	--	--	--	--	--	
		E	32.285 (348) 露台 Balcony: 2.000 (22) 工作平台 Utility Platform: 1.500 (16)	--	--	--	--	--	--	--	--	--	--	--	
		F	32.183 (346) 露台 Balcony: 2.000 (22) 工作平台 Utility Platform: 1.500 (16)	--	--	--	--	--	--	--	--	--	--	--	
		G	32.233 (347) 露台 Balcony: 2.000 (22) 工作平台 Utility Platform: 1.500 (16)	--	--	--	--	--	--	--	--	--	--	--	
		H	49.055 (528) 露台 Balcony: 2.000 (22) 工作平台 Utility Platform: 1.500 (16)	--	--	--	--	--	--	--	--	--	--	--	--
		J	51.300 (552) 露台 Balcony: 2.000 (22) 工作平台 Utility Platform: 1.500 (16)	--	--	--	--	--	--	--	--	--	--	--	--

The saleable area of each residential property and, the floor areas of balcony, utility platform and verandah (if any) are calculated in accordance with section 8 of the Residential Properties (First-hand Sales) Ordinance; and the areas of other specified items (not included in the saleable area) are calculated in accordance with Part 2 of Schedule 2 of the Residential Properties (First-hand Sales) Ordinance.

The area as specified above in square feet are converted at a rate of 1 square metre = 10.764 square feet and rounded off to the nearest whole square foot. Which may be slightly different from that shown in square metres. Residential floors 4/F, 13/F, 14/F, 24/F, 34/F and 44/F of Tower 5 are omitted. 25/F of Tower 5 is refuge floor.

每個住宅物業的實用面積、以及露台、工作平台及陽台（如有）之樓面面積，是按照《一手住宅物業銷售條例》第8條計算得出的。其他指明項目的面積（不計算入實用面積），是按照《一手住宅物業銷售條例》附表2第2部計算得出的。

上述以平方呎顯示之面積，均以1平方米=10.764平方呎換算，並以四捨五入至整數平方呎，平方呎與平方米顯示之面積可能有些微差異。

第5座住宅樓層不設4樓、13樓、14樓、24樓、34樓及44樓。第5座住宅25樓為庇護層。

Area of Residential Properties 住宅物業的面積

Description of Residential Property 住宅物業的描述			Saleable Area (including balcony, utility platform and verandah, if any) sq. meter (sq. ft.) 實用面積 (包括露台, 工作平台及陽台 (如有)) 平方米 (平方呎)	Area of other specified items (Not included in the Saleable Area) 其他指明項目的面積 (不計算入實用面積) sq. metre (sq. ft.) 平方米 (平方呎)										
Tower 座	Floor 樓層	Unit 單位		Air-conditioning plant room 空調機房	Bay Window 窗台	Cockloft 閣樓	Flat roof 平台	Garden 花園	Parking space 停車位	Roof 天台	Stairhood 梯屋	Terrace 前庭	Yard 庭院	
Tower 5 第5座	26/F - 33/F, 35/F - 43/F, 45/F - 49/F (34/F & 44/F are omitted) 26樓 - 33樓、 35樓 - 43樓、 45樓 - 49樓 (不設34樓及 44樓)	A	62.541 (673) 露台 Balcony: 2.204 (24) 工作平台 Utility Platform: 1.500 (16)	--	--	--	--	--	--	--	--	--	--	
		B	45.674 (492) 露台 Balcony: 0.000 (0) 工作平台 Utility Platform: 1.500 (16)	--	--	--	--	--	--	--	--	--	--	--
		C	87.937 (947) 露台 Balcony: 3.105 (33) 工作平台 Utility Platform: 1.500 (16)	--	--	--	--	--	--	--	--	--	--	--
		D	62.780 (676) 露台 Balcony: 3.275 (35) 工作平台 Utility Platform: 1.500 (16)	--	--	--	--	--	--	--	--	--	--	--
		E	32.285 (348) 露台 Balcony: 2.000 (22) 工作平台 Utility Platform: 1.500 (16)	--	--	--	--	--	--	--	--	--	--	--
		F	32.183 (346) 露台 Balcony: 2.000 (22) 工作平台 Utility Platform: 1.500 (16)	--	--	--	--	--	--	--	--	--	--	--
		G	32.233 (347) 露台 Balcony: 2.000 (22) 工作平台 Utility Platform: 1.500 (16)	--	--	--	--	--	--	--	--	--	--	--
		H	49.000 (527) 露台 Balcony: 2.000 (22) 工作平台 Utility Platform: 1.500 (16)	--	--	--	--	--	--	--	--	--	--	--
		J	51.300 (552) 露台 Balcony: 2.000 (22) 工作平台 Utility Platform: 1.500 (16)	--	--	--	--	--	--	--	--	--	--	--

The saleable area of each residential property and, the floor areas of balcony, utility platform and verandah (if any) are calculated in accordance with section 8 of the Residential Properties (First-hand Sales) Ordinance; and the areas of other specified items (not included in the saleable area) are calculated in accordance with Part 2 of Schedule 2 of the Residential Properties (First-hand Sales) Ordinance.

The area as specified above in square feet are converted at a rate of 1 square metre = 10.764 square feet and rounded off to the nearest whole square foot. Which may be slightly different from that shown in square metres. Residential floors 4/F, 13/F, 14/F, 24/F, 34/F and 44/F of Tower 5 are omitted. 25/F of Tower 5 is refuge floor.

每個住宅物業的實用面積、以及露台、工作平台及陽台(如有)之樓面面積, 是按照《一手住宅物業銷售條例》第8條計算得出的。其他指明項目的面積(不計算入實用面積), 是按照《一手住宅物業銷售條例》附表2第2部計算得出的。

上述以平方呎顯示之面積, 均以1平方米=10.764平方呎換算, 並以四捨五入至整數平方呎, 平方呎與平方米顯示之面積可能有些微差異。

第5座住宅樓層不設4樓、13樓、14樓、24樓、34樓及44樓。第5座住宅25樓為庇護層。

Area of Residential Properties 住宅物業的面積

Description of Residential Property 住宅物業的描述			Saleable Area (including balcony, utility platform and verandah, if any) sq. meter (sq. ft.) 實用面積 (包括露台, 工作平台及陽台 (如有)) 平方米 (平方呎)	Area of other specified items (Not included in the Saleable Area) 其他指明項目的面積 (不計算入實用面積) sq. metre (sq. ft.) 平方米 (平方呎)										
Tower 座	Floor 樓層	Unit 單位		Air-conditioning plant room 空調機房	Bay Window 窗台	Cockloft 閣樓	Flat roof 平台	Garden 花園	Parking space 停車位	Roof 天台	Stairhood 梯屋	Terrace 前庭	Yard 庭院	
Tower 5 第5座	50/F 50樓	C	63.065 (679) 露台 Balcony: 3.275 (35) 工作平台 Utility Platform: 1.500 (16)	--	--	--	--	--	--	--	--	--	--	
		D	32.000 (344) 露台 Balcony: 2.000 (22) 工作平台 Utility Platform: 1.500 (16)	--	--	--	--	--	--	--	--	--	--	--
		E	106.453 (1,146) 露台 Balcony: 2.000 (22) 工作平台 Utility Platform: 1.500 (16)	--	--	--	--	--	--	--	--	--	--	--
		F	51.300 (552) 露台 Balcony: 2.000 (22) 工作平台 Utility Platform: 1.500 (16)	--	--	--	--	--	--	--	--	--	--	--
	51/F 51樓	C	63.475 (683) 露台 Balcony: 3.275 (35) 工作平台 Utility Platform: 1.500 (16)	--	--	--	--	--	--	54.780 (590)	--	--	--	--
		D	32.000 (344) 露台 Balcony: 2.000 (22) 工作平台 Utility Platform: 1.500 (16)	--	--	--	--	--	--	17.938 (193)	--	--	--	--
		E	106.454 (1,146) 露台 Balcony: 2.000 (22) 工作平台 Utility Platform: 1.500 (16)	--	--	--	--	--	--	54.132 (583)	--	--	--	--
		F	51.300 (552) 露台 Balcony: 2.000 (22) 工作平台 Utility Platform: 1.500 (16)	--	--	--	--	--	--	46.770 (503)	--	--	--	--
	50/F & 51/F (Duplex) 50樓及51樓 (複式)	A	185.918 (2,001) 露台 Balcony: 2.234 (24) 工作平台 Utility Platform: 0.000 (0)	--	--	--	10.123 (109)	--	--	71.696 (772)	6.063 (65)	--	--	--
		B	145.788 (1,569) 露台 Balcony: 2.000 (22) 工作平台 Utility Platform: 0.000 (0)	--	--	--	7.954 (86)	--	--	61.078 (657)	5.940 (64)	--	--	--

The saleable area of each residential property and, the floor areas of balcony, utility platform and verandah (if any) are calculated in accordance with section 8 of the Residential Properties (First-hand Sales) Ordinance; and the areas of other specified items (not included in the saleable area) are calculated in accordance with Part 2 of Schedule 2 of the Residential Properties (First-hand Sales) Ordinance.

The area as specified above in square feet are converted at a rate of 1 square metre = 10.764 square feet and rounded off to the nearest whole square foot. Which may be slightly different from that shown in square metres. Residential floors 4/F, 13/F, 14/F, 24/F, 34/F and 44/F of Tower 5 are omitted. 25/F of Tower 5 is refuge floor.

每個住宅物業的實用面積、以及露台、工作平台及陽台(如有)之樓面面積,是按照《一手住宅物業銷售條例》第8條計算得出的。其他指明項目的面積(不計算入實用面積),是按照《一手住宅物業銷售條例》附表2第2部計算得出的。

上述以平方呎顯示之面積,均以1平方米=10.764平方呎換算,並以四捨五入至整數平方呎,平方呎與平方米顯示之面積可能有些微差異。

第5座住宅樓層不設4樓、13樓、14樓、24樓、34樓及44樓。第5座住宅25樓為庇護層。

- Residential Car Parking Space
住宅車輛停車位
- Residential Accessible Parking Space*
住宅暢通易達停車位*
- Residential Visitors' Parking Space
住宅訪客停車位
- Residential Motor Cycle Parking Space
住宅電單車停車位
- Commercial Car Parking Space
商業車輛停車位
- Commercial Motor Cycle Parking Space
商業電單車停車位
- Kindergarten Parking Space
幼稚園停車位
- Site Boundary of the Development
發展項目邊界

Note*:

- (1) Designated out of Residential Car Parking Space, Residential Visitors' Parking Space and Commercial Car Parking Space.
- (2) Under Special Condition 48(c)(ii) of Land Grant, Residential Accessible Parking Spaces shall be used for parking of motor vehicles by disabled persons belonging to the residents, their bona fide guests, visitors and invitees.

備註*:

- (1) 由住宅車輛停車位、住宅訪客停車位及商業車輛停車位劃出。
- (2) 根據批地文件特別批地條款第48(c)(ii)條，住宅暢通易達停車位為供傷殘人士停泊屬於住戶及彼等真正賓客、訪客或獲邀請人士之車輛。



BASEMENT
地庫

Scale 0 25M/米
比例

- Residential Bicycle Parking Space
住宅單車停車位
- Commercial Loading and Unloading Bay
商業上落貨停車位
- Kindergarten Taxi & Private Car Lay-by
幼稚園的士及私家車停車處
- Kindergarten School Bus Lay-by
幼稚園學校巴士停車處
- Refuse Collection Vehicle Parking Space
垃圾收集車停車位
- Site Boundary of the Development
發展項目邊界

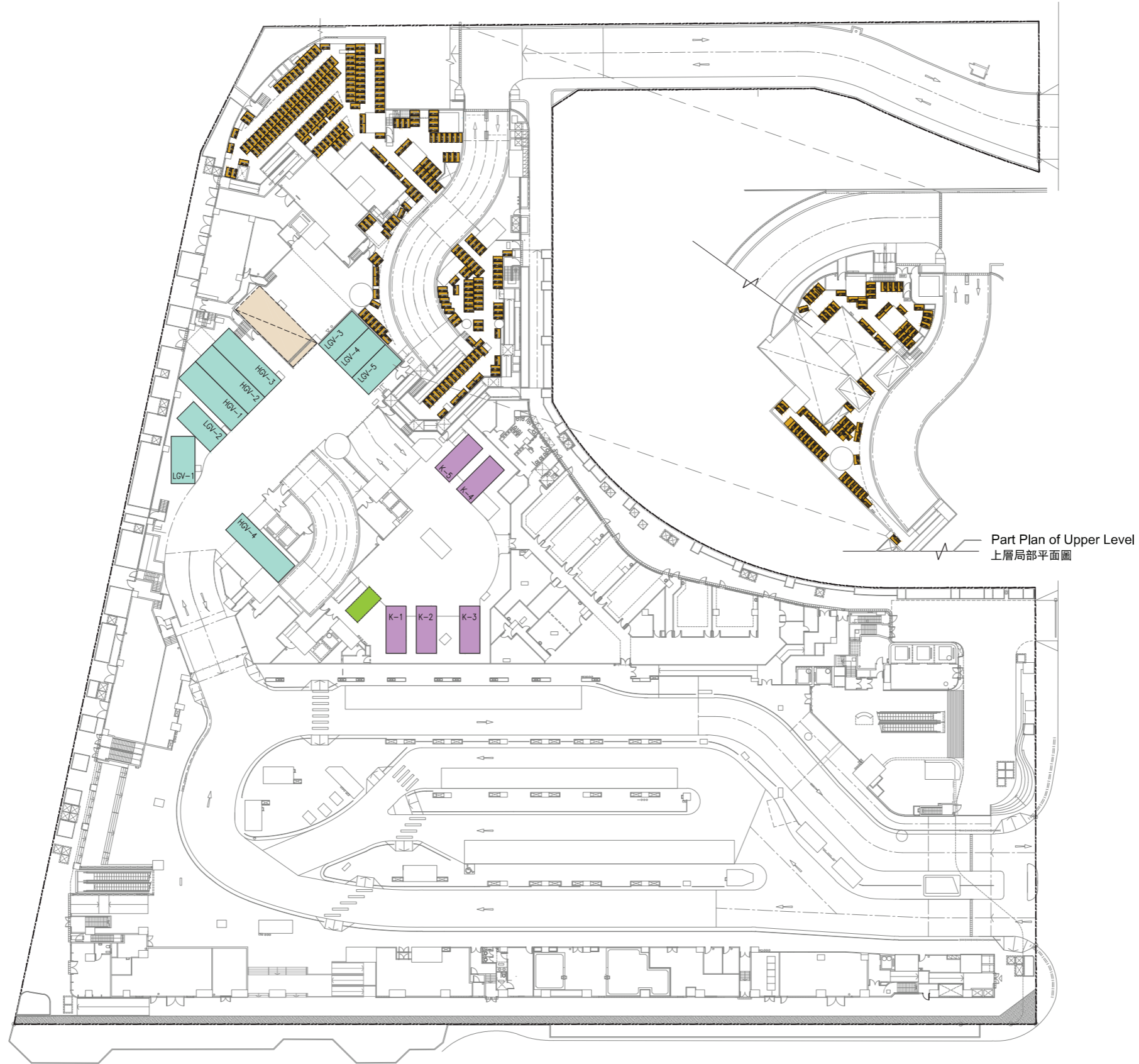

Part Plan of Upper Level
上層局部平面圖

GROUND FLOOR
地下

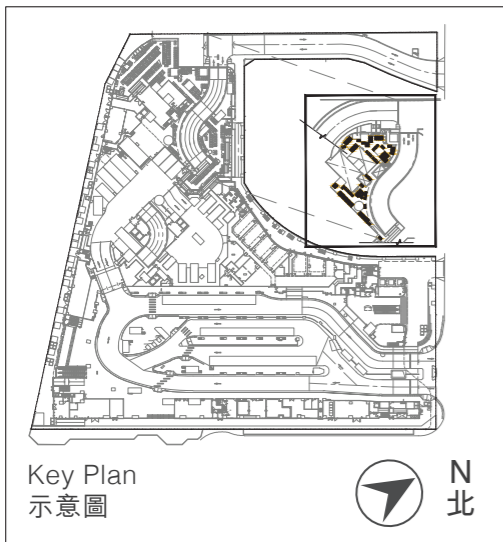

Scale 0 25M/米
比例

- Residential Bicycle Parking Space
住宅單車停車位
- Site Boundary of the Development
發展項目邊界



PART PLAN OF UPPER GROUND LEVEL
地上上層平面圖

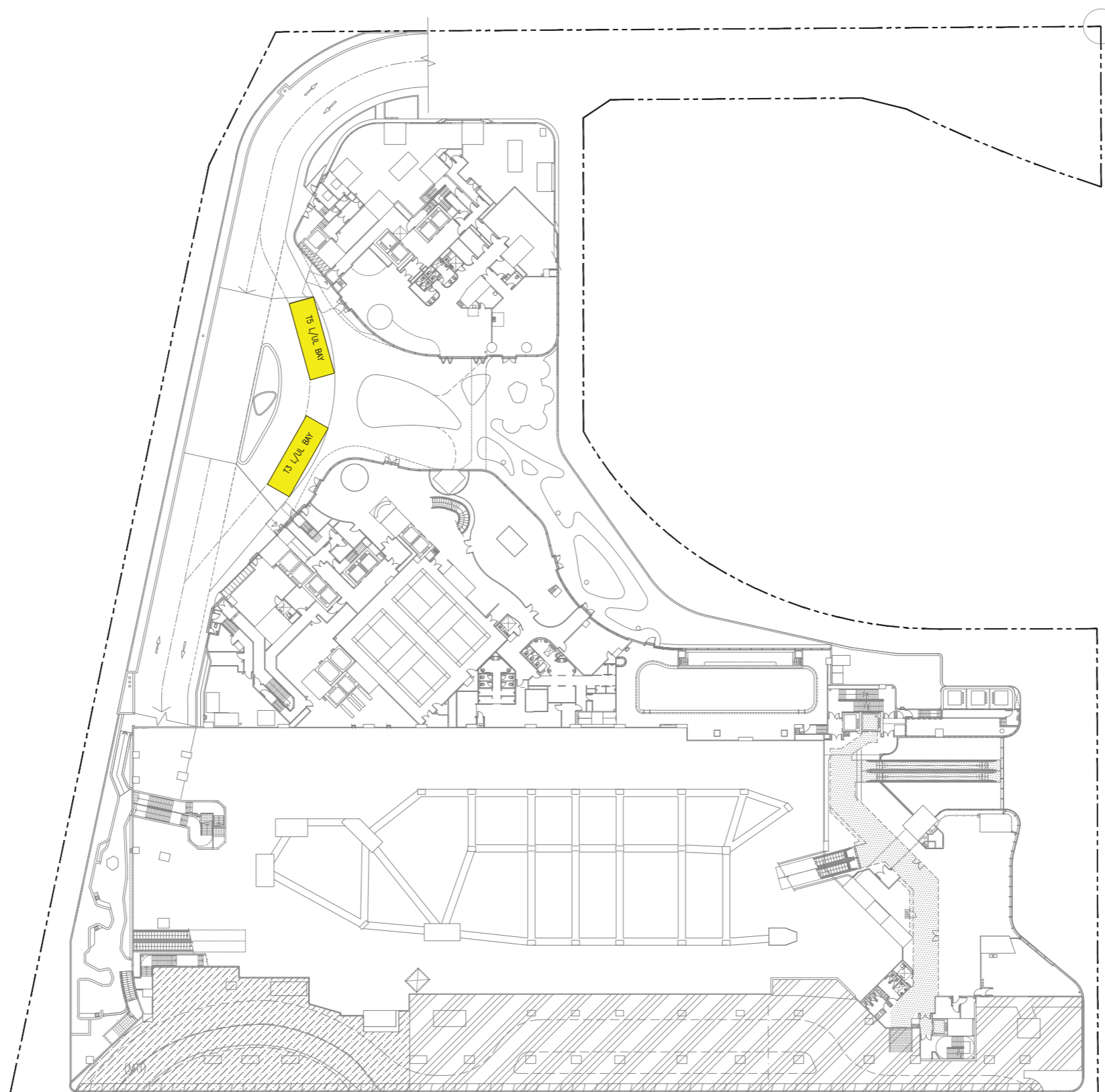

Scale 0 10M/米
比例

-  Residential Loading and Unloading Bay
住宅上落貨停車位
-  Site Boundary of the Development
發展項目邊界



1ST FLOOR
一樓

Scale 0 25M/米
比例 

-  Residential Loading and Unloading Bay
住宅上落貨停車位
-  Site Boundary of the Development
發展項目邊界

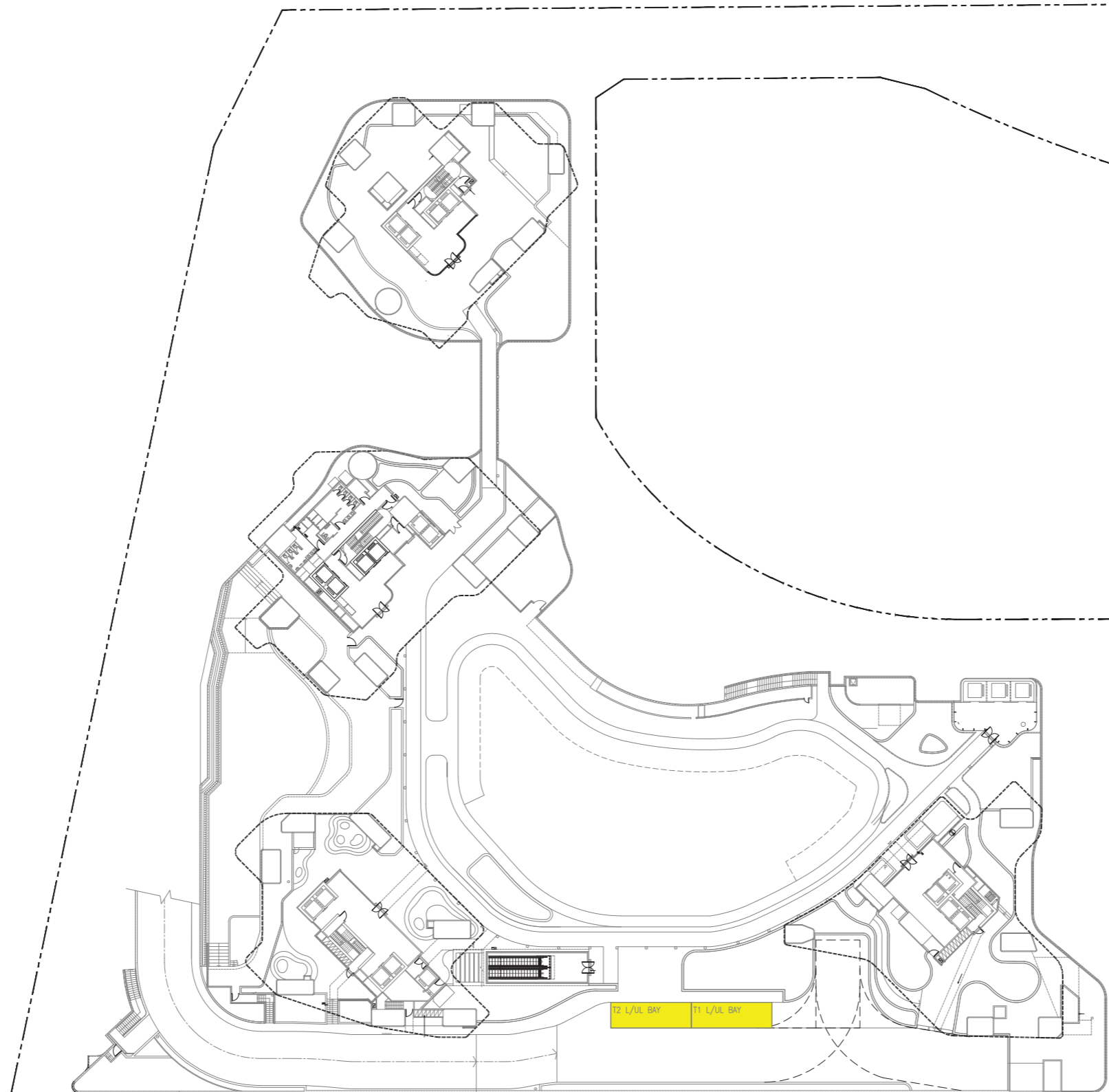

P FLOOR
基座平台

Scale 0 25M/米
比例 

Floor 樓層	Category of parking space 停車位類別		Number 數目	Dimensions (L x W) (m) 尺寸 (長X闊) (米)	Area of each parking space (sq.m) 每個停車位面積 (平方米)
B/F 地庫	Residential 住宅	Car Parking Space 車輛停車位	196	5 x 2.5	12.5
		Visitors' Parking Space 訪客停車位	18	5 x 2.5	12.5
		Accessible Parking Space* 暢通易達停車位*	4	5 x 3.5	17.5
		Motor Cycle Parking Space 電單車停車位	20	2.5 x 1	2.5
G/F 地下		Bicycle Parking Space 單車停車位	334	1.4 x 0.8	1.12
1/F 1樓		Loading and Unloading Bay 上落貨車位	2	11 x 3.5	38.5
P/F 基座平台		Loading and Unloading Bay 上落貨車位	2	11 x 3.5	38.5
B/F 地庫	Commercial 商業	Car Parking Space 車輛停車位	35	5 x 2.5	12.5
		Motor Cycle Parking Space 電單車停車位	4	2.5 x 1	2.5
G/F 地下		Loading and Unloading Bay 上落貨車位	4	11 x 3.5	38.5
	5		7 x 3.5	24.5	
B/F 地庫		Parking Space 停車位	1	5 x 2.5	12.5
G/F 地下	Kindergarten 幼稚園	Taxi & Private Car Lay-by 的士及私家車停車處	1	5 x 2.5	12.5
		School Bus Lay-by 學校巴士停車處	5	7 x 3	21
		Refuse Collection Vehicle Parking Space 垃圾收集車停車位	1	12 x 5	60

Note*:

- (1) Designated out of Residential Car Parking Space, Residential Visitors' Parking Space and Commercial Car Parking Space.
(2) Under Special Condition 48(c)(ii) of Land Grant, Residential Accessible Parking Spaces shall be used for parking of motor vehicles by disabled persons belonging to the residents, their bona fide guests, visitors and invitees.

備註*:

- (1) 由住宅車輛停車位、住宅訪客停車位及商業車輛停車位劃出。
(2) 根據批地文件特別批地條款第48(c)(ii)條，住宅暢通易達停車位為供傷殘人士停泊屬於住戶及彼等真正賓客、訪客或獲邀請人士的車輛。

1. A preliminary deposit of 5% of the purchase price is payable on the signing of the preliminary agreement for sale and purchase.
 2. The preliminary deposit paid by the purchaser on the signing of that preliminary agreement for sale and purchase will be held by a firm of solicitors acting for the Vendor (the owner), as stakeholders.
 3. If the purchaser fails to execute the formal agreement for sale and purchase within 5 working days after the date on which the purchaser enters into that preliminary agreement for sale and purchase –
 - (i) that preliminary agreement for sale and purchase is terminated;
 - (ii) the preliminary deposit is forfeited; and
 - (iii) the owner does not have any further claim against the purchaser for the failure.
1. 在簽署臨時買賣合約時須支付款額為樓價之5%的臨時訂金。
 2. 買方在簽署該臨時買賣合約時支付的臨時訂金，會由代表賣方（擁有人）行事的律師事務所以保證金保存人的身份持有。
 3. 如買方沒有於訂立該臨時買賣合約的日期之後 5 個工作日內簽立正式買賣合約 –
 - (i) 該臨時買賣合約即告終止；
 - (ii) 有關的臨時訂金即予沒收；及
 - (iii) 擁有人不得就買方沒有簽立正式買賣合約而針對買方提出進一步申索。

1. The common parts of the Development

"Common Areas" means collectively the Estate Common Areas, the Residential Common Areas, the Residential Car Park Common Areas, the Residential and Residential Car Park Common Areas and in the event Units in the Commercial Development are disposed of individually, such Commercial Development common areas as shall be defined in the relevant Sub-Deed in respect of the Commercial Development and in the event Units in the Commercial Car Park are disposed of individually, such Commercial Car Park common areas as shall be defined in the relevant Sub-Deed in respect of the Commercial Car Park and each of which Common Areas shall, where applicable, include those appropriate and relevant common parts specified in Schedule 1 to the Building Management Ordinance (Cap.344).

"Common Areas and Facilities" means collectively the Common Areas and the Common Facilities.

"Common Facilities" means collectively the Estate Common Facilities, the Residential Common Facilities, the Residential Car Park Common Facilities, the Residential and Residential Car Park Common Facilities and in the event Units in the Commercial Development are disposed of individually, such Commercial Development common facilities as shall be defined in the relevant Sub-Deed in respect of the Commercial Development and in the event Units in the Commercial Car Park are disposed of individually, such Commercial Car Park common facilities as shall be defined in the relevant Sub-Deed in respect of the Commercial Car Park.

"Estate Common Areas" means those parts of the Estate intended for the common use and benefit of the Estate as a whole and not just any particular Unit and which are subject to the provisions of the Deed of Mutual Covenant and all subsisting rights and rights of way to be used by each Owner and Occupier in common with all other Owners and Occupiers of the Estate which said parts include but not limited to:-

- (a) the foundations, columns, beams, slabs and other structural supports and elements that do not belong to or do not form part of the Residential Development, the Government Accommodation, the Commercial Development, the G/F Shop, the Kindergarten and Spaces, the Residential Car Park or the Commercial Car Park;
- (b) the Slopes and Retaining Walls (if any);
- (c) areas for the installation or use of aerial broadcast distribution or telecommunications network facilities save and except those of such areas which form part of the Residential Common Areas;
- (d) those parts of the Greenery Area as shown and coloured red crossed black on the plan annexed to the Deed of Mutual Covenant;
- (e) (for the purpose of management and maintenance only) the Items;
- (f) those parts of the Pedestrian Walkway which for identification purpose only are shown and coloured red double hatched black on the plan annexed to the Deed of Mutual Covenant;
- (g) refuse storage and material recovery chamber, refuse collection vehicles spaces, circulation and manoeuvring spaces;
- (h) all those other parts and areas of the Estate as shown and coloured red and red double hatched black on the plans annexed to the Deed of Mutual Covenant;

1. 發展項目的公用部份

「公用地方」統指屋苑公用地方，住宅公用地方，住宅停車場公用地方，住宅及住宅停車場公用地方及如商業發展的單位個別出售，將包括關於商業發展的副公契內所界定為商業發展的公用地方及如商業停車場的車位個別出售，將包括關於商業停車場的副公契內所界定為商業停車場的公用地方及就每個公用地方，在適用的情況下，包括《建築物管理條例》（第344章）附表1所列舉的適當及相關公用部份。

「公用地方與設施」統指公用地方與公用設施。

「公用設施」統指屋苑公用設施，住宅公用設施，住宅停車場公用設施，住宅及住宅停車場公用設施及如商業發展的單位個別出售，將包括關於商業發展的副公契內所界定為商業發展的公用設施及如商業停車場的車位個別出售，將包括關於商業停車場的副公契內所界定為商業停車場的公用設施。

「屋苑公用地方」指擬供屋苑整體而並非只供任何個別單位公用及共享的屋苑部份，受制於公契條款及所有現存的權利及通行權，每個擁有人及佔用人可與其他所有屋苑擁有人及佔用人共用該等部份，該等部份包括但不限於：-

- (a) 不屬於或不構成住宅發展，政府樓宇，商業發展，地舖，幼稚園及場地，住宅停車場或商業停車場一部份的地基，柱，樑，樓板及其他結構性支承物及元素；
- (b) 斜坡及護土牆（如有）；
- (c) 提供安裝或使用天線廣播分導或電訊網絡設施的範圍但構成住宅公用地方之一部份的範圍除外；
- (d) 公契所夾附的圖則以紅色加黑色十字顯示的綠化範圍部份；
- (e) （只為作管理及保養為目的）該等物件；
- (f) 公契所夾附的圖則以紅色加雙黑斜線顯示的行人走道部份；
- (g) 垃圾及物料回收房，垃圾收集車車位，流動及迴旋位；
- (h) 公契所夾附的圖則以紅色及紅色加雙黑斜線顯示的屋苑其他部份及範圍；

- (i) all those strips of the external walls with the whole thicknesses thereof of the Estate for the purpose of identification only as shown and coloured red on the plans annexed to the Deed of Mutual Covenant;
- (j) all those strips of the external walls of the Estate comprising the total thickness of such external walls including the cladding but excluding a thickness of 30mm from the internal/interior of such external walls with their respective locations and dimensions for the purpose of identification only as shown and coloured red hatched black with black dashed lines on the plans annexed to the Deed of Mutual Covenant;
- (k) all that strip of the external walls of the Estate with the thickness of 30mm from the internal/interior of such strip of the external walls with its location and dimensions for the purpose of identification only as shown and coloured indigo triangulated black on the plan annexed to the Deed of Mutual Covenant; and
- (l) such additional parts and areas of the Estate as may at any time be designated as Estate Common Areas by the First Owner subject to the approval by a resolution of Owners at an Owners' meeting convened in accordance with the provisions of the Deed of Mutual Covenant,

BUT (for the avoidance of doubt) excluding the Residential Common Areas, the Residential Car Park Common Areas and the Residential and Residential Car Park Common Areas.

"Estate Common Areas and Facilities" means collectively the Estate Common Areas and the Estate Common Facilities.

"Estate Common Facilities" means all those facilities intended for the common use and benefit of the Estate as a whole and not just any particular part thereof which are subject to the provisions of the Deed of Mutual Covenant to be used by each Owner and Occupier in common with all other Owners and Occupiers of the Estate and includes but not limited to those parts (if any) of the Utilities within the Lot and the Estate, sewers, drains, storm water drains, water courses, cables, pipes, wires, ducts, flushing mains, fresh water mains, plant and machinery and other like installations, facilities or services, the transformer room, cable accommodations and all associated facilities and ancillary electricity installation, equipment and facilities for the supply of electricity to the Estate and such additional devices and facilities of the Estate as may at any time be designated as Estate Common Facilities by the First Owner subject to the approval by a resolution of Owners at an Owners' meeting convened in accordance with the provisions of the Deed of Mutual Covenant BUT (for the avoidance of doubt) excluding the Residential Common Facilities, the Residential Car Park Common Facilities and the Residential and Residential Car Park Common Facilities.

"Residential Car Park Common Areas" means all those parts of the Residential Car Park excluding the Residential Car Parking Spaces intended for the common use and benefit of the Residential Car Park as a whole and not just any particular Residential Car Parking Space which are subject to the provisions of the Deed of Mutual Covenant to be used by each Owner and Occupier of the Residential Car Parking Spaces in common with all other Owners and Occupiers of the Residential Car Parking Spaces, which Residential Car Park Common Areas include but not limited to:-

- (a) all those areas for the purpose of identification only shown and coloured yellow on the plans annexed to the Deed of Mutual Covenant;
- (b) all those strips of the external walls of the Estate with the thickness of 30mm from the internal/interior of such external walls with their respective locations and dimensions for the purpose of identification only as shown and coloured red hatched black with black dashed lines and green hatched black with black dashed lines on the plans annexed to the Deed of Mutual Covenant; and

- (i) 公契所夾附的圖則以紅色顯示的屋苑的該等外牆之全厚度；
- (j) 公契所夾附的圖則以紅色加黑斜線加黑虛線顯示的屋苑的該等外牆包含其全部厚度及覆蓋層但不包括由其內部/室內的30毫米厚度；
- (k) 公契所夾附的圖則以藍色加黑色三角顯示的屋苑的該等外牆由其內部/室內的30毫米厚度；及
- (l) 由首位擁有人在任何時候按照公契條款召開的業主會議中通過的業主決議指定用作屋苑公用地方的其他屋苑額外部份及範圍，

但（為免存疑）並不包括住宅公用地方，住宅停車場公用地方及住宅及住宅停車場公用地方。

「屋苑公用地方與設施」統指屋苑公用地方與屋苑公用設施。

「屋苑公用設施」指擬供屋苑整體而並非只供任何個別部份公用及共享的設施，受制於公契條款，每個擁有人及佔用人可與其他所有屋苑擁有人及佔用人共用該等設施，包括但不限於該地段及屋苑內的公共設施部份（如有），污水管，排水渠，雨水渠，水道，電纜，水管，電線，管槽，總沖廁水管，總食水管，機器及機械和其他類似的裝置，設施或服務，變壓房，電纜設備及為屋苑提供電力的所有相關設施及輔助電力裝置，設備及設施，以及由首位擁有人在任何時候按照公契條款召開的業主會議中通過的業主決議指定用作屋苑公用設施的其他屋苑額外裝置及設施，但（為免存疑）並不包括住宅公用設施，住宅停車場公用設施及住宅及住宅停車場公用設施。

「住宅停車場公用地方」指擬供住宅停車場整體而並非只供任何個別住宅車輛停車位公用及共享的住宅停車場部份但不包括住宅車輛停車位，受制於公契條款供每個住宅車輛停車位擁有人及佔用人可與其他所有住宅車輛停車位的擁有人及佔用人共用該等部份，包括但不限於：-

- (a) 於公契所夾附的圖則以黃色顯示範圍；
- (b) 公契所夾附的圖則以紅色加黑斜線加黑虛線及綠色加黑斜線加黑虛線顯示的屋苑的該等外牆由其內部/室內的30毫米厚度；及

(c) such additional parts and areas of the Estate as may at any time be designated as Residential Car Park Common Areas by the First Owner subject to the approval by a resolution of Owners at an Owners' meeting convened in accordance with the provisions of the Deed of Mutual Covenant, BUT (for the avoidance of doubt) excluding the Estate Common Areas, the Residential Common Areas and the Residential and Residential Car Park Common Areas.

"Residential Car Park Common Areas and Facilities" means collectively the Residential Car Park Common Areas and the Residential Car Park Common Facilities.

"Residential Car Park Common EV Facilities" means all such facilities of the Residential Car Park intended for the common use and benefit of the Owners and Occupiers of the Residential Car Parking Spaces for the purpose of or in relation to the charging of electric motor vehicles or electric motor cycles parking at any of the Residential Car Parking Spaces; such facilities shall not belong to any of the Owner of the Residential Car Parking Spaces and shall include but not limited to such trunking and socket outlet for or in relation to such purpose.

"Residential Car Park Common Facilities" means all those facilities of the Residential Car Park, including but not limited to the Residential Car Park Common EV Facilities, intended for the common use and benefit of the Owners and Occupiers of the Residential Car Parking Spaces BUT (for the avoidance of doubt) excluding the Estate Common Facilities, the Residential Common Facilities and the Residential and Residential Car Park Common Facilities.

"Residential Common Areas" means those parts of the Residential Development intended for the common use and benefit of the Residential Development as a whole and not just any particular Residential Unit and which are subject to the provisions of the Deed of Mutual Covenant to be used by each Owner and Occupier of the Residential Units in common with all other Owners and Occupiers of the Residential Units and shall include:-

(a) areas for the installation or use of aerial broadcast distribution or telecommunications network facilities save and except those of such areas which form part of the Estate Common Areas;

(b) the external walls (including non-structural prefabricated external wall) of the Towers not forming part of the Residential Units including:-

(1) the architectural features, grilles and fins thereon (including roof features on private flat roofs and private roofs of the relevant Residential Units as shown on the Building Plans); and

(2) the air-conditioner platforms (including the louvers thereof (if any)) adjacent to the Residential Units or such other area(s), if any, as may be designated for that purpose, BUT excluding:-

(A) the glass/metal balustrades or railings of the balconies, utility platforms, private flat roofs or private roofs which shall belong to and form part(s) of the relevant Residential Units; and

(B) such pieces of glass panels wholly enclosing or fronting a Residential Unit and the openable parts of the curtain wall structures of the Towers which said glass panels and openable parts shall form

(c) 由首位擁有人在任何時候按照公契條款召開的業主會議中通過的業主決議指定用作住宅停車場公用地方的其他屋苑額外部份及範圍，但（為免存疑）並不包括屋苑公用地方，住宅公用地方及住宅及住宅停車場公用地方。

「住宅停車場公用地方與設施」統指住宅停車場公用地方與住宅停車場公用設施。

「住宅停車場公用電動車設施」指於住宅停車場供住宅車輛停車位之擁有人及佔用人公用及共享以供給相關停泊於任何住宅車輛停車位的電動車或電動單車充電的該等設施；而該等設施並不屬於任何住宅車輛停車位的擁有人，包括但不限於相關的線槽及電源插座。

「住宅停車場公用設施」指擬供住宅車輛停車位之擁有人及佔用人公用及共享的住宅停車場設施，包括但不限於住宅停車場公用電動車設施，但（為免存疑）並不包括屋苑公用設施，住宅公用設施及住宅及住宅停車場公用設施。

「住宅公用地方」指擬供住宅發展整體而並非只供任何個別住宅單位公用及共享的住宅發展部份，受制於公契條款，每個住宅單位擁有人及佔用人可與其他所有住宅單位擁有人及佔用人共用該等部份，包括：-

(a) 提供安裝或使用天線廣播分導或電訊網絡設施的範圍但構成屋苑公用地方之一部份的範圍除外；

(b) 並非屬於住宅單位的座的外牆（包括非結構的預製外牆）包括：-

(1) 在其上的建築裝飾，格柵及簷（包括相關住宅單位的私人平台及私人天台上並顯示於建築圖則的屋頂特色）；及

(2) 毗連住宅單位的冷氣機平台（包括其百葉窗（如有的話）），或指定用作安放冷氣機的其他地方（如有）；但不包括：-

(A) 屬於及構成相關住宅單位部份的露台，工作平台，私人平台或私人天台的玻璃/金屬欄杆或欄杆；及

(B) 完全包圍或面向住宅單位的玻璃嵌板及座的玻璃幕牆結構可開啟的部份，而上述玻璃嵌板及可開啟部份構成有關住宅單位的部份，而為免存疑，任何構成玻璃幕牆結構一部份而並非完全包圍一個住宅單位而

parts of the relevant Residential Units and for the avoidance of doubt, any glass panel forming part of the curtain wall structures that does not wholly enclose a Residential Unit but extends across two or more Residential Units shall form part of the Residential Common Areas;

- (c) all those strips of the external walls with the whole thickness thereof of the Estate at and below the transfer plate which for the purpose of identification only are shown and coloured green on the plans annexed to the Deed of Mutual Covenant;
- (d) all that strip of the external walls of the Estate at the transfer plate comprising the total thickness of such external walls but excluding (i) a thickness of 100mm from the exterior surface of the concrete of such external walls, and (ii) the cladding beyond the exterior of such concrete surface, with its location and dimension for the purpose of identification only as shown and coloured indigo hatched black circled black on the plan annexed to the Deed of Mutual Covenant;
- (e) all those strips of the external walls of the Estate below the transfer plate comprising the total thickness of such external walls including the cladding but excluding a thickness of 30mm from the internal/interior of such external walls with their respective locations and dimensions for the purpose of identification only as shown and coloured green hatched black with black dashed lines on the plan annexed to the Deed of Mutual Covenant;
- (f) all those strips of the external walls of the Estate below the transfer plate with the thickness of 30mm from the internal/interior of such external walls with their respective locations and dimensions for the purpose of identification only as shown and coloured indigo hatched black on the plans annexed to the Deed of Mutual Covenant;
- (g) those parts of the Greenery Area as shown and coloured green crossed black on the plans annexed to the Deed of Mutual Covenant;
- (h) office accommodation for watchmen and caretakers provided in accordance with Special Condition No.(34)(a) of the Government Grant;
- (i) office for the use of the Owners' Corporation or the Owners' Committee provided in accordance with Special Condition No.(36)(a) of the Government Grant;
- (j) quarters (if any) for watchmen and caretakers provided in accordance with Special Condition No.(35)(a) of the Government Grant;
- (k) the Covered Walkway;
- (l) the Recreational Areas and Facilities;
- (m) lift lobby of each of the Towers (other than the private lift lobby which forms part of a Residential Unit);
- (n) fireman's lift lobby;
- (o) the Bicycle Parking Spaces;
- (p) the Residential Loading and Unloading Spaces;

是申延跨越兩個或多個住宅單位的玻璃嵌板，將構成住宅公用地方的一部份；

- (c) 公契所夾附的圖則以綠色顯示位於屋苑結構轉換厚板及其之下的該等外牆之全厚度；
- (d) 公契所夾附的圖則以藍色加黑斜線加黑色圓圈顯示位於屋苑結構轉換厚板的外牆包含其全厚度的外牆，但不包括(i)該外牆由其混凝土表面外部的100毫米厚度，及(ii)該混凝土表面外部伸延的覆蓋層；
- (e) 公契所夾附的圖則以綠色加黑斜線加黑虛線顯示位於屋苑結構轉換厚板之下的該等外牆包含其全部厚度包括覆蓋層但不包括由其等內部/室內的30毫米厚度；
- (f) 公契所夾附的圖則以藍色加黑斜線顯示位於屋苑結構轉換厚板之下的該等外牆由其等內部/室內的30毫米厚度；
- (g) 公契所夾附的圖則以綠色加黑色十字顯示的綠化範圍部份；
- (h) 根據批地文件特別批地條款第(34)(a)條提供的看更及管理員的辦公場地；
- (i) 根據批地文件特別批地條款第(36)(a)條提供予業主立案法團或業主委員會使用的辦事處；
- (j) 根據批地文件特別批地條款第(35)(a)條提供的看更及管理員的宿舍（如有）；
- (k) 有蓋行人路；
- (l) 康樂地方及設施；
- (m) 每座電梯大堂（除卻構成住宅單位一部份的私人電梯大堂）；
- (n) 消防電梯大堂；
- (o) 單車停車位；
- (p) 住宅貨車上落客貨車位；

- (q) the Visitors' Parking Spaces;
- (r) the Residential Parking Spaces for the Disabled;
- (s) the refuge floor which is located on the 25th floor of each of the Towers;
- (t) the Covered Landscape Area;
- (u) the areas landscaped of the Estate which for identification purpose only are shown and coloured green and marked "LANDSCAPE AREA" on the plans annexed to the Deed of Mutual Covenant;
- (v) all those flat roofs and/or portions thereof on 5th floor of each of the Towers not forming part of the Residential Units which for identification purpose only are shown and coloured green and marked "COMMON FLAT ROOF" on the plans annexed to the Deed of Mutual Covenant;
- (w) all those parts and areas on 5th floor of each of the Towers not forming part of the Residential Units which for identification purpose only are shown and coloured green and respectively marked "CONC. ENC. DR. P" and "AW. DR. P" on the plans annexed to the Deed of Mutual Covenant;
- (x) all those other parts and areas of the Residential Development as shown and coloured green on the plans annexed to the Deed of Mutual Covenant; and
- (y) such additional parts and areas of the Estate as may at any time be designated as Residential Common Areas by the First Owner subject to the approval by a resolution of Owners at an Owners' meeting convened in accordance with the provisions of the Deed of Mutual Covenant, BUT (for the avoidance of doubt) excluding the Estate Common Areas, the Residential Car Park Common Areas and the Residential and Residential Car Park Common Areas.

"Residential Common Areas and Facilities" means collectively the Residential Common Areas and the Residential Common Facilities.

"Residential Common Facilities" means all those facilities intended for the common use and benefit of the Residential Development as a whole and not just any particular Residential Unit which are subject to the provisions of the Deed of Mutual Covenant to be used by each Owner and Occupier of the Residential

- (q) 訪客停車位；
- (r) 住宅傷殘人士停車位；
- (s) 位於每座25樓的庇護層；
- (t) 有蓋園景區；
- (u) 公契所夾附的圖則以綠色及“LANDSCAPE AREA”標記顯示的屋苑園景範圍；
- (v) 每座5樓不構成住宅單位部份的該等平台及/或其該等部份於公契所夾附的圖則以綠色及“COMMON FLAT ROOF”標記顯示；
- (w) 每座5樓不構成住宅單位部份的該等部份及範圍於公契所夾附的圖則以綠色及“CONC. ENC. DR. P”及“AW. DR. P”標記顯示；
- (x) 於公契所夾附的圖則上以綠色顯示的住宅發展所有其他部份及範圍；及
- (y) 由首位擁有人在任何時候按照公契條款召開的業主會議中通過的業主決議指定用作住宅公用地方的其他屋苑額外部份及範圍，但（為免存疑）並不包括屋苑公用地方，住宅停車場公用地方及住宅及住宅停車場公用地方。

「住宅公用地方與設施」統指住宅公用地方與住宅公用設施。

「住宅公用設施」指擬供住宅發展整體而並非只供任何個別住宅單位公用及共享的設施，受制於公契條款，每個住宅單位擁有人及佔用人可與所有其他住宅單位擁有人及佔用人共用該等設施，當中包括但不限於減音垂直簾，噪音消滅措施（不包括該等構成及/或獨家服務予一住宅單位），訪客停車位的電動車設施，電梯（包括，

Units in common with all other Owners and Occupiers of the Residential Units and includes but not limited to acoustic vertical fins, the Noise Mitigation Measures (excluding those forming part of and/or serving exclusively a Residential Unit), the EV Facilities for Visitors' Parking Spaces, lifts (including, for the avoidance of doubt, the lift doors and the surface of the lift doors facing the private lift lobby of a Residential Unit), all wires, cables, ducts, pipes, drains, the transformer room, cable accommodations and all associated facilities and ancillary electricity installation, equipment and facilities for the supply of electricity to the Residential Development as a whole and not just any particular Residential Unit and all mechanical and electrical installations and equipment exclusively for the Residential Development and such additional devices and facilities of the Estate as may at any time be designated as Residential Common Facilities by the First Owner subject to the approval by a resolution of Owners at an Owners' meeting convened in accordance with the provisions of the Deed of Mutual Covenant BUT (for the avoidance of doubt) excluding the Estate Common Facilities, the Residential Car Park Common Facilities and the Residential and Residential Car Park Common Facilities. For the further avoidance of doubt, those installations made by and belonging to the provider(s) of the telecommunications and broadcasting services (if any) shall not form parts of the Residential Common Facilities.

"Residential and Residential Car Park Common Areas" means such part of the Estate intended for the common use and benefit of both the Residential Development and the Residential Car Park as a whole and not just any particular Residential Unit or Residential Car Parking Space which for identification purpose only is shown and coloured green cross hatched black on the plans annexed to the Deed of Mutual Covenant and which are subject to the provisions of the Deed of Mutual Covenant to be used by each Owner and Occupier of the Residential Units or the Residential Car Parking Spaces in common with all other Owners and Occupiers of the Residential Units or the Residential Car Parking Spaces and such additional parts and areas of the Estate as may at any time be designated as Residential and Residential Car Park Common Areas by the First Owner subject to the approval by a resolution of Owners at an Owners' meeting convened in accordance with the provisions of the Deed of Mutual Covenant BUT (for the avoidance of doubt) excluding the Estate Common Areas, the Residential Common Areas and the Residential Car Park Common Areas.

"Residential and Residential Car Park Common Areas and Facilities" means collectively the Residential and Residential Car Park Common Areas and the Residential and Residential Car Park Common Facilities.

"Residential and Residential Car Park Common Facilities" means all those facilities intended for the common use and benefit of both the Residential Development and the Residential Car Park as a whole and not just any particular Residential Unit or Residential Car Parking Space which are subject to the provisions of the Deed of Mutual Covenant to be used by each Owner and Occupier of the Residential Units and the Residential Car Parking Spaces in common with all other Owners and Occupiers of the Residential Units and the Residential Car Parking Spaces BUT (for the avoidance of doubt) excluding the Estate Common Facilities, the Residential Common Facilities and the Residential Car Park Common Facilities.

為免存疑，電梯門及面向住宅單位之私人電梯大堂的電梯門表面），所有電線，電纜，導管，喉管，排水渠，變壓房，電纜設備及為住宅發展整體而並非只供任何個別住宅單位提供電力的所有相關設施及輔助電力裝置，設備及設施，及所有專屬住宅發展的機電裝置及設備，以及由首位擁有人在任何時候按照公契條款召開的業主會議中通過的業主決議指定用作住宅公用設施的其他屋苑額外裝置及設施，但（為免存疑）並不包括屋苑公用設施，住宅停車場公用設施及住宅及住宅停車場公用設施。再為免存疑，由電訊及廣播（如有）供應商所作出及屬於其的裝置並不構成住宅公用設施一部份。

「住宅及住宅停車場公用地方」指擬供住宅發展及住宅停車場整體而並非只供任何個別住宅單位或住宅車輛停車位公用及共享的屋苑部份，受制於公契條款，供每個住宅單位或住宅車輛停車位擁有人及佔用人可與所有其他住宅單位或住宅車輛停車位擁有人及佔用人共用該等部份，而該等部份於公契所夾附的圖則以綠色加黑斜線顯示，及由首位擁有人在任何時候按照公契條款召開的業主會議中通過的業主決議指定用作住宅及住宅停車場公用地方的其他屋苑額外部份及範圍，但（為免存疑）並不包括屋苑公用地方，住宅公用地方及住宅停車場公用地方。

「住宅及住宅停車場公用地方與設施」統指住宅及住宅停車場公用地方與住宅及住宅停車場公用設施。

「住宅及住宅停車場公用設施」指擬供住宅及住宅車輛停車位整體而並非只供任何個別住宅及住宅車輛停車位公用及共享的設施，受制於公契條款，供每個住宅單位或住宅車輛停車位擁有人及佔用人可與所有其他住宅單位或住宅車輛停車位擁有人及佔用人共用該等設施，但（為免存疑）並不包括屋苑公用設施，住宅公用設施及住宅停車場公用設施。

2. The number of undivided shares assigned to each residential property in the Development

Tower	Floor	Unit	The Number of Undivided Shares to each Residential Property
1	5/F	A	65
		B	31
		C	21
		D	43
		E	51
		F	30
		G	48
		H	50
		6/F-12/F & 15/F-23/F	A
	B		31
	C		21
	D		43
	E		53
	F		31
	G		50
	H		53
	26/F-33/F, 35/F-43/F & 45/F-48/F		A
		B	31
		C	21
		D	43
		E	53
		F	31
		G	50
		H	53
		49/F	A
	B		121
	C		114

2. 分配予發展項目中的每個住宅物業的不分割份數的數目

座	樓層	單位	分配予每個住宅物業的不分割份數的數目
1	5樓	A	65
		B	31
		C	21
		D	43
		E	51
		F	30
		G	48
		H	50
		6樓-12樓及15樓-23樓	A
	B		31
	C		21
	D		43
	E		53
	F		31
	G		50
	H		53
	26樓-33樓, 35樓-43樓及45樓-48樓		A
		B	31
		C	21
		D	43
		E	53
		F	31
		G	50
		H	53
		49樓	A
	B		121
	C		114

In the numbering of floors, 4/F, 13/F, 14/F, 24/F, 34/F and 44/F are omitted. 25/F is refuge floor.
In the numbering of Towers, Tower 4 is omitted.

不設4樓、13樓、14樓、24樓、34樓及44樓。25樓為庇護層。
不設第4座。

Tower	Floor	Unit	The Number of Undivided Shares to each Residential Property
2	5/F	A	29
		B	42
		C	76
		D	52
		E	33
		F	69
		G	52
		H	23
		6/F-12/F, 15/F-23/F, 26/F-33/F, 35/F-43/F & 45/F-47/F	A
	B		45
	C		79
	D		54
	E		36
	F		72
	G		54
	H		24
	48/F		A
		B	45
		C	79
		D	64
		E	46
		F	72
		G	54
		H	24
		49/F	A
	B		157

座	樓層	單位	分配予每個住宅物業的不分割份數的數目
2	5樓	A	29
		B	42
		C	76
		D	52
		E	33
		F	69
		G	52
		H	23
		6樓-12樓, 15樓-23樓, 26樓-33樓, 35樓-43樓及 45樓-47樓	A
	B		45
	C		79
	D		54
	E		36
	F		72
	G		54
	H		24
	48樓		A
		B	45
		C	79
		D	64
		E	46
		F	72
		G	54
		H	24
		49樓	A
	B		157

Tower	Floor	Unit	The Number of Undivided Shares to each Residential Property
3	5/F	A	60
		B	45
		C	86
		D	59
		E	30
		F	30
		G	30
		H	67
		J	49
		6/F-12/F & 15/F-23/F	A
	B		48
	C		88
	D		63
	E		32
	F		32
	G		32
	H		70
	J		51
	26/F-33/F, 35/F-43/F & 45/F-49/F		A
		B	48
		C	88
		D	63
		E	32
		F	32
		G	32
		H	70
		J	51
		50/F	C
	D		32
	E		99
F	51		
51/F	C		97
	D	42	
	E	109	
	F	61	
50/F & 51/F	A (Duplex Unit)	203	
	B (Duplex Unit)	171	

座	樓層	單位	分配予每個住宅物業的不分割份數的數目
3	5樓	A	60
		B	45
		C	86
		D	59
		E	30
		F	30
		G	30
		H	67
		J	49
		6樓-12樓及15樓-23樓	A
	B		48
	C		88
	D		63
	E		32
	F		32
	G		32
	H		70
	J		51
	26樓-33樓, 35樓-43樓及45樓-49樓		A
		B	48
		C	88
		D	63
		E	32
		F	32
		G	32
		H	70
		J	51
		50樓	C
	D		32
	E		99
F	51		
51樓	C		97
	D	42	
	E	109	
	F	61	
50樓及51樓	A (複式單位)	203	
	B (複式單位)	171	

In the numbering of floors, 4/F, 13/F, 14/F, 24/F, 34/F and 44/F are omitted. 25/F is refuge floor.
In the numbering of Towers, Tower 4 is omitted.

不設4樓、13樓、14樓、24樓、34樓及44樓。25樓為庇護層。
不設第4座。

Tower	Floor	Unit	The Number of Undivided Shares to each Residential Property
5	5/F	A	60
		B	45
		C	86
		D	61
		E	30
		F	30
		G	30
		H	47
		J	49
		6/F-12/F & 15/F-23/F	A
	B		46
	C		88
	D		63
	E		32
	F		32
	G		32
	H		49
	J		51
	26/F-33/F, 35/F-43/F & 45/F-49/F		A
		B	46
		C	88
		D	63
		E	32
		F	32
		G	32
		H	49
		J	51
		50/F	C
	D		32
	E		106
	F		51
	51/F		C
D		42	
E		116	
F		61	
50/F & 51/F	A (Duplex Unit)	205	
	B (Duplex Unit)	164	

座	樓層	單位	分配予每個住宅物業的不分割份數的數目
5	5樓	A	60
		B	45
		C	86
		D	61
		E	30
		F	30
		G	30
		H	47
		J	49
		6樓-12樓及15樓-23樓	A
	B		46
	C		88
	D		63
	E		32
	F		32
	G		32
	H		49
	J		51
	26樓-33樓, 35樓-43樓及45樓-49樓		A
		B	46
		C	88
		D	63
		E	32
		F	32
		G	32
		H	49
		J	51
		50樓	C
	D		32
	E		106
	F		51
	51樓		C
D		42	
E		116	
F		61	
50樓及51樓	A (複式單位)	205	
	B (複式單位)	164	

3. The term of years for which the manager of the Development is appointed

The Manager is to be appointed for an initial term of two years from the date of the Deed of Mutual Covenant and to be continued thereafter until termination of the Manager's appointment in accordance with the provisions thereof.

4. The basis on which the management expenses are shared among the owners of the residential properties in the Development

Each Owner of a Residential Unit shall contribute towards the Management Expenses of the Development in such manner, amount and proportion as provided in the Deed of Mutual Covenant by reference to the Management Units allocated to his Residential Unit and the principles provided in the Deed of Mutual Covenant. The number of Management Units allocated to a Residential Unit is the same as the number of Undivided Shares as set out in paragraph 2 above.

5. The basis on which the management fee deposit is fixed

The management fee deposit is equivalent to three months' management contribution based on the first annual Management Budget payable by the Owner in respect of his Unit.

6. The area (if any) in the Development retained by the vendor for its own use

Not applicable.

3. 有關發展項目的管理人的委任年期

管理人首屆任期由簽訂公契日期起計兩年，其後續任至按公契的條文終止管理人的委任為止。

4. 管理開支按什麼基準在發展項目中的住宅物業的擁有人之間分擔

每名住宅單位業主應按照公契訂明的方式、金額和比例，根據其住宅單位的管理份數和公契列明的準則，分擔發展項目的管理開支。分配予每個住宅單位的管理份數的數目與上述第2段列出的住宅單位的不分割份數的數目相同。

5. 計算管理費按金的基準

管理費按金相等於擁有人就其單位按首個年度管理預算案釐定而須繳的三個月管理費。

6. 擁有人在發展項目中保留作自用的範圍（如有的話）

不適用。

Notes:

1. Unless otherwise defined in this sales brochure, the capitalized terms used in this Summary of Deed of Mutual Covenant shall have the same meaning of such terms in the Deed of Mutual Covenant.
2. For full details, please refer to the Draft Deed of Mutual Covenant which is free for inspection during opening hours at the sales office. Full script of the Draft Deed of Mutual Covenant is available for inspection upon request and copies of the Draft Deed of Mutual Covenant can be obtained upon paying necessary photocopying charges.

備註：

1. 除本售樓說明書另有定義外，本公契的摘要中使用的定義詞語具有其在公契中的相同涵義。
2. 請查閱公契擬稿以了解全部詳情。完整的公契擬稿可於售樓處開放時間內免費查閱，並且可支付所需影印費用後取得公契擬稿的副本。

1. The development is situated on the Remaining Portion of Sha Tin Town Lot No.576 (the "lot").
 2. The lot is held under the Agreement and Conditions of Exchange dated 4th September 2017 and registered in the Land Registry as New Grant No. 22528 (the "Land Grant") for a term of 50 years commencing from the 4th September 2017 subject to and with the benefit of an Approval Letter dated 24th May 2021 and registered in the Land Registry by Memorial No.21052702540010 (the "Approval Letter").
 3. Special Condition No.(14) of the Land Grant stipulates that:
The lot or any part thereof or any building or part of any building erected or to be erected thereon shall not be used for any purpose other than for non-industrial (excluding godown, hotel, and petrol filling station) purposes.
 4. General Condition No.(4) of the Land Grant stipulates that:
The Grantee hereby indemnifies and shall keep indemnified the Government against all actions, proceedings, liabilities, demands, costs, expenses, losses (whether financial or otherwise) and claims whatsoever and howsoever arising from any breach of these Conditions or any damage or soil and groundwater contamination caused to adjacent or adjoining land or to the lot where such damage or soil and groundwater contamination has, in the opinion of the Director of Lands (hereinafter referred to as "the Director", and whose opinion shall be final and binding upon the Grantee), arisen out of any use of the lot, or any development or redevelopment of the lot or part thereof or out of any activities carried out on the lot or out of any other works carried out thereon by the Grantee whether or not such use, development or redevelopment, activities or works are in compliance with these Conditions or in breach thereof.
 5. General Condition No.(6) of the Land Grant stipulates that:
(a) The Grantee shall throughout the tenancy having built or rebuilt (which word refers to redevelopment as contemplated in sub-clause (b) of this General Condition) in accordance with these Conditions:
(i) maintain all buildings in accordance with the approved design, disposition or height and any approved building plans without variation or modification thereto; and
(ii) maintain all buildings erected or which may hereafter be erected in accordance with these Conditions or any subsequent contractual variation of them, in good and substantial repair and condition and in such repair and condition deliver up the same at the expiration or sooner determination of the tenancy.
(b) In the event of the demolition at any time during the tenancy of any building then standing on the lot or any part thereof the Grantee shall replace the same either by sound and substantial building or buildings of the same type and of no less gross floor area or by building or buildings of such type and value as shall be approved by the Director. In the event of demolition as aforesaid the Grantee shall within one calendar month of such demolition apply to the Director for consent to carry out building works for the redevelopment of the lot and upon receiving such consent shall within three calendar months thereof commence the necessary works of redevelopment and shall complete the same to the satisfaction of and within such time limit as is laid down by the Director.
 6. General Condition No.(8) of the Land Grant stipulates that:
Any private streets, roads and lanes which by these Conditions are required to be formed shall be sited to the satisfaction of the Director and included in or excluded from the area to be leased as may be determined by him and in either case shall be surrendered to the Government free of cost if so required. If the said streets, roads and lanes are surrendered to the Government, the surfacing, kerbing, draining (both foul and storm water sewers), channelling and road lighting thereof shall be carried out by the Government at the expense of the Grantee and thereafter they shall be maintained at public expense. If the said private streets, roads and lanes remain part of the area to be leased, they shall be lighted, surfaced, kerbed, drained, channelled and maintained by and at the expense of the Grantee in all respects to the satisfaction of the Director and the Director may carry out or cause to be carried out the installation and maintenance of road lighting for the sake of public interest as required. The Grantee shall bear the capital cost of installation of road lighting and allow free ingress and egress to and from the area to be leased to workmen and vehicles for the purpose of installation and maintenance of the road lighting.
1. 發展項目所在土地位於沙田市地段第576號餘段（「該地段」）。
 2. 據訂立於2017年9月4日的換地協議及條件並於土地註冊處註冊為第22528號新批地契（「批地文件」）批出，該地段的批地年期由2017年9月4日起計50年並受制及受益於一份日期為2021年5月24日，以註冊摘要號碼21052702540010於土地註冊處註冊的批准信（「批准信」）。
 3. 批地文件特別批地條款第(14)條規定：
該地段或其任何部份或現已或將會興建於其上的任何建築物或任何建築物部份，除作非工業用途（酒店、加油站及貨倉例外）外，不可作任何其他用途。
 4. 批地文件一般批地條款第(4)條規定：
承批人如有違反此等條款，或承批人導致毗連或毗鄰土地或該地段損害或泥土及地下水污染，而地政總署署長（以下稱「署長」，及其意見將作最終決定並對承批人具有約束力）認為上述損害或泥土及地下水污染是因承批人使用該地段、或發展或重新發展該地段或其任何部份、或於該地段上進行任何活動或工程所致，不論有關的使用、發展或重新發展、進行活動或工程乃遵從或違反此等批地條款亦然，承批人須彌償政府所有由此導致的訴訟、法律程序、責任、訴求、費用、開支、損失（不論財務或其他性質）及索償和確保其免責。
 5. 批地文件一般批地條款第(6)條規定：
(a) 承批人須於整個批地年期內就根據此等條款進行的建築或重建（該詞指本一般批地條款第(b)條提及的重新發展）：
(i) 按已批准的設計、規劃與高度及任何已批准的建築圖則保養所有建築物，不得對其作出更改或修訂；及
(ii) 保養現已興建或將會可能按此等條款或其隨後任何契約修改本興建的所有建築物，使其保持修葺良好堅固和狀況良好，並在批地年期屆滿或提前終止時以同樣的修葺狀況交還。
(b) 倘若在租約期內任何時候拆卸當時在該地段或其任何部份之上存在的任何建築物，承批人須以相同類型和不少於原有總樓面面積的健全及堅固的一幢或多幢建築物或署長批准的類型和價值的一幢或多幢建築物作為代替。倘若進行上述拆卸，承批人須在該拆卸的1個曆月內向署長提出申請以取得其同意在該地段進行重新發展的建築工程，並在收到上述同意後的3個曆月內展開所需的重新發展工程及在署長規定的時限內完成，以令署長滿意。
 6. 批地文件一般批地條款第(8)條規定：
此等條款訂明拓建的任何私家街、私家路及後巷，選址必須令署長滿意，並按照署長決定納入或不涵蓋於批租之土地範圍並且無論屬何情況，必須有需要時無須代價歸還予政府。如向政府歸還上述私家街、私家路及後巷，政府將進行該處的路面、路緣石、排水渠（包括污水及雨水渠）、渠道及路燈建設工程，費用由承批人支付，其後則以公帑保養。如上述私家街、私家路及後巷仍屬於批租土地一部份，承批人須自費在該處提供照明、路面、路緣石、排水渠、渠道並自費保養，以令署長全面滿意。署長可基於公眾利益按需要在該處進行或促使進行路燈安裝和保養路燈。承批人須承擔路燈之安裝工程資本開支，並且允許工人及車輛自由進出批租土地範圍，以便安裝和保養。

7. Special Condition No.(2) of the Land Grant stipulates that:
The Grantee acknowledges that there are some buildings and structures existing on the old lots and undertakes to demolish and remove at his own expense the said buildings and structures from the old lots. The Government will accept no responsibility or liability for any damage, nuisance or disturbance caused to or suffered by the Grantee by reason of the presence of the said buildings and structures and the Grantee shall indemnify and keep indemnified the Government from and against all liability, claims, costs, demands, actions or other proceedings whatsoever arising whether directly or indirectly out of or in connection with the presence and subsequent demolition and removal of the said buildings and structures.
8. Special Condition No.(5) of the Land Grant stipulates that:
- (a) The Grantee shall:
- (i) within 84 calendar months from the date of this Agreement (or such other extended periods as may be approved by the Director), at his own expense, in such manner with such materials and to such standards, levels, alignment and design as the Director shall approve and in all respects to the satisfaction of the Director:
 - (I) lay and form those portions of future public roads shown coloured green on PLAN I (hereinafter referred to as "the Green Area"); and
 - (II) provide and construct such bridges, tunnels, over-passes, under-passes, culverts, viaducts, flyovers, pavements, roads or such other structures as the Director in his sole discretion may require (hereinafter collectively referred to as "the Green Area Structures") so that building, vehicular and pedestrian traffic may be carried on the Green Area;
 - (ii) within 84 calendar months from the date of this Agreement or such other extended periods as may be approved by the Director, at his own expense and to the satisfaction of the Director, surface, kerb and channel the Green Area and provide the same with such gullies, sewers, drains, fire hydrants with pipes connected to water mains, street lights, traffic signs, street furniture and road markings as the Director may require; and
 - (iii) maintain at his own expense the Green Area together with the Green Area Structures and all structures, surfaces, gullies, sewers, drains, fire hydrants, services, street lights, traffic signs, street furniture, road markings and plant constructed, installed and provided thereon or therein to the satisfaction of the Director until such time as possession of the Green Area has been delivered in accordance with Special Condition No.(6) hereof.
- (b) The Grantee shall:
- (i) within 48 calendar months from the date of this Agreement (or such other extended periods as may be approved by the Director), at his own expense, in such manner with such materials and to such standards, levels, alignment and design as the Director shall approve and in all respects to the satisfaction of the Director:
 - (I) lay and form those portions of future public roads shown coloured green stippled black on PLAN I (hereinafter referred to as "the Green Stippled Black Area"); and
 - (II) provide and construct such bridges, tunnels, over-passes, under-passes, culverts, viaducts, flyovers, pavements, roads or such other structures as the Director in his sole discretion may require (hereinafter collectively referred to as "the Green Stippled Black Area Structures") so that building, vehicular and pedestrian traffic may be carried on the Green Stippled Black Area;
 - (ii) within 48 calendar months from the date of this Agreement or such other extended periods as may be approved by the Director, at his own expense and to the satisfaction of the Director, surface, kerb and channel the Green Stippled Black Area and provide the same with such gullies, sewers, drains, fire hydrants with pipes connected to water mains, street lights, traffic signs, street furniture and road markings as the Director may require; and
 - (iii) maintain at his own expense the Green Stippled Black Area together with the Green Stippled Black Area Structures and all structures, surfaces, gullies, sewers, drains, fire hydrants, services, street lights, traffic signs, street furniture, road markings and plant constructed, installed and provided thereon or therein to the satisfaction of the Director until such time as possession of the Green Stippled Black Area has been delivered in accordance with Special Condition No.(6) hereof.
- (c) In the event of the non-fulfilment of the Grantee's obligations under sub-clauses (a) or (b) of this Special Condition within the prescribed period stated therein, the Government may carry out the necessary works at the cost of the Grantee who shall pay to the Government on demand a sum equal to the cost thereof, such sum to be determined by the Director whose determination shall be final and binding upon the Grantee.
7. 批地文件特別批地條款第(2)條規定：
承批人現確認舊有地段上建有現存建築物及結構物並承諾自費拆卸和移除舊有地段的該建築物及結構物。政府將不會對任何因該建築物及結構物的存在導致或令承批人蒙受之損害、滋擾或騷擾承擔任何責任或義務，並且承批人須就該建築物及結構物的存在及進行拆卸及移除工程直接或間接導致或產生的所有及任何性質的責任、索償、費用、訴求、訴訟或其他法律程序向政府彌償，並確保其免責。
8. 批地文件特別批地條款第(5)條規定：
- (a) 承批人必須：
- (i) 在本協議簽定日起84個曆月（或署長批准的其他延長日期）內，自費以署長批准的方式及物料，按署長批准的標準、水平、定線和設計，以令署長全面滿意：
 - (I) 鋪設及構造在批地文件所夾附圖則I內以綠色顯示的日後興建公共道路部份（以下稱「綠色範圍」）；及
 - (II) 提供及建造署長全權酌情決定要求的橋樑、隧道、上跨路、下通道、暗渠、高架道路、天橋、行人路、道路或其他構築物（以下統稱「綠色範圍構築物」）以致可在綠色範圍進行興建建築物及供車輛及行人往來；
 - (ii) 在本協議簽定日起84個曆月內或署長批准的其他延長日期，自費令署長滿意於綠色範圍表面整飾、興建路緣及渠道，以及按署長要求為此等設施提供溝渠、污水管、排水渠、消防栓及接駁主水管的水管、街燈、交通標誌、街道設施及道路標記；及
 - (iii) 自費保養綠色範圍連同綠色範圍構築物及在該處上及內建造、裝設及提供的所有結構物、路面、溝渠、污水管、排水渠、消防栓、服務設施、街燈、交通標誌、街道設施、道路標記及植物使署長滿意，直至根據本文特別批地條款第(6)條交還綠色範圍的管有權為止。
- (b) 承批人必須：
- (i) 在本協議簽定日起48個曆月（或署長批准的其他延長日期）內，自費以署長批准的方式及物料，按署長批准的標準、水平、定線和設計，以令署長全面滿意：
 - (I) 鋪設及構造在批地文件所夾附圖則I內以綠色加黑點顯示的日後興建公共道路部份（以下稱「綠色加黑點範圍」）；及
 - (II) 提供及建造署長全權酌情決定要求的橋樑、隧道、上跨路、下通道、暗渠、高架道路、天橋、行人路、道路或其他構築物（以下統稱「綠色加黑點範圍構築物」）以致可在綠色加黑點範圍進行興建建築物及供車輛及行人往來；
 - (ii) 在本協議簽定日起48個曆月內或署長批准的其他延長日期，自費令署長滿意在綠色加黑點範圍表面整飾、興建路緣及渠道，以及按署長要求為此等設施提供溝渠、污水管、排水渠、消防栓及接駁主水管的水管、街燈、交通標誌、街道設施及道路標記；及
 - (iii) 自費保養綠色加黑點範圍連同綠色加黑點範圍構築物及在該處上及內建造、裝設及提供的所有結構物、路面、溝渠、污水管、排水渠、消防栓、服務設施、街燈、交通標誌、街道設施、道路標記及植物使署長滿意，直至根據本文特別批地條款第(6)條交還綠色加黑點範圍的管有權為止。
- (c) 倘若承批人未能於規定日期內履行其在本特別批地條款第(a)或(b)條的義務，政府可進行必要的工程，費用一概由承批人負責，承批人須應政府要求向其支付相等於該等費用的金額，該金額由署長決定，其決定為最終決定及對承批人具有約束力。

- (d) The Director shall have no liability in respect of any loss, damage, nuisance or disturbance whatsoever caused to or suffered by the Grantee or any other person whether arising out of or incidental to the fulfilment of the Grantee's obligations under sub-clauses (a) and (b) of this Special Condition or the exercise of the rights by the Government under sub-clause (c) of this Special Condition or otherwise, and no claim for compensation shall be made against the Government or the Director or his authorized officer by the Grantee in respect of any such loss, damage, nuisance or disturbance.
9. Special Condition No.(6) of the Land Grant stipulates that:
For the purpose only of carrying out the necessary works specified in Special Condition No.(5) hereof, the Grantee shall on the date of this Agreement be granted possession of the Green Area and the Green Stippled Black Area. The Green Area and the Green Stippled Black Area shall be re-delivered to the Government on demand and in any event shall be deemed to have been re-delivered to the Government by the Grantee on the date of a letter from the Director indicating that these Conditions have been complied with to his satisfaction. The Grantee shall at all reasonable times while he is in possession of the Green Area and the Green Stippled Black Area allow free access over and along the Green Area and the Green Stippled Black Area for all Government and public vehicular and pedestrian traffic and shall ensure that such access shall not be interfered with or obstructed by the carrying out of the works whether under Special Condition No.(5) hereof or otherwise.
10. Special Condition No.(7) of the Land Grant stipulates that:
The Grantee shall not without the prior written consent of the Director use the Green Area and the Green Stippled Black Area for the purpose of storage or for the erection of any temporary structure or for any purposes other than the carrying out of the works specified in Special Condition No.(5) hereof.
11. Special Condition No.(8) of the Land Grant stipulates that:
(a) The Grantee shall at all reasonable times while he is in the possession of the Green Area and the Green Stippled Black Area:
(i) permit the Director, his officers, contractors and any other persons authorized by him, the right of ingress, egress and regress to, from and through the lot and the Green Area and the Green Stippled Black Area for the purpose of inspecting, checking and supervising any works to be carried out in compliance with Special Condition Nos.(5)(a) and (5)(b) hereof and the carrying out, inspecting, checking and supervising of the works under Special Condition No.(5)(c) hereof and any other works which the Director may consider necessary in the Green Area and the Green Stippled Black Area;
(ii) permit the Government and the relevant public utility companies authorized by the Government the right of ingress, egress and regress to, from and through the lot and the Green Area and the Green Stippled Black Area as the Government or the relevant public utility companies may require for the purpose of any works to be carried out in, upon or under the Green Area and the Green Stippled Black Area or any adjoining land including but not limited to the laying and subsequent maintenance of all pipes, wire, conduits, cable-ducts and other conducting media and ancillary equipment necessary for the provision of telephone, electricity, gas (if any) and other services intended to serve the lot or any adjoining or neighbouring land or premises. The Grantee shall co-operate fully with the Government and also with the relevant public utility companies duly authorized by the Government on all matters relating to any of the aforesaid works to be carried out within the Green Area and the Green Stippled Black Area; and
(iii) permit the officers of the Water Authority and such other persons as may be authorized by them the right of ingress, egress and regress to, from and through the lot and the Green Area and the Green Stippled Black Area as the officers of the Water Authority or such authorized persons may require for the purpose of carrying out any works in relation to the operation, maintenance, repairing, replacement and alteration of any other waterworks installations within the Green Area and the Green Stippled Black Area.
(b) The Government shall have no liability in respect of any loss, damage, nuisance or disturbance whatsoever caused to or suffered by the Grantee or any other person arising out of or incidental to the exercise of the rights by the Government, its officers, agents, contractors, and any other persons or public utility companies duly authorized under sub-clause (a) of this Special Condition.
- (d) 倘因承批人履行本特別批地條款第(a)條及(b)條的義務或政府行使本特別批地條款第(c)條權力或其他情況，不論因處理或附帶之事宜而導致或令承批人或其他任何人士蒙受任何損失、損害、滋擾或騷擾，署長概不承擔任何責任，及承批人不得就任何該等損失、損害、滋擾或騷擾向政府或署長或獲其授權人員作出索償賠償。
9. 批地文件特別批地條款第(6)條規定：
茲為進行本文特別批地條款第(5)條規定的必要工程，承批人於本協議日獲綠色範圍及綠色加黑點範圍的管有權。承批人須在政府要求時將綠色範圍及綠色加黑點範圍交還予政府，及無論何時須在署長發出的信函說明所有該等批地條款已妥善履行並令其滿意當日將被視為已由承批人交還予政府。承批人在管有綠色範圍及綠色加黑點範圍期間，須於一切合理時間內允許所有政府及公眾車輛及行人自由通行及經越綠色範圍及綠色加黑點範圍，並確保該通行不會因為進行工程及不論是否根據本文特別批地條款第(5)條進行的工程而受到干擾或妨礙。
10. 批地文件特別批地條款第(7)條規定：
未經署長事先書面同意，承批人不得將綠色範圍及綠色加黑點範圍用作儲物或興建任何臨時結構物或用作進行本文特別批地條款第(5)條規定的工程以外的任何其他用途。
11. 批地文件特別批地條款第(8)條規定：
(a) 承批人須於管有綠色範圍及綠色加黑點範圍的所有合理時間內：
(i) 批准署長及其人員、承建商及獲署長授權的其他任何人士有權通行、進出、往返及行經該地段及綠色範圍，以便視察、檢查及監督遵照本文特別批地條款第(5)(a)及(5)(b)條規定進行的任何工程，以及進行、視察、檢查及監督本文特別批地條款第(5)(c)條規定的工程及署長認為於綠色範圍及綠色加黑點範圍內必要的任何其他工程；
(ii) 在政府或獲其授權的相關公用設施公司要求時，批准政府或獲其授權的相關公用設施公司有權通行、進出、往返及行經該地段、綠色範圍及綠色加黑點範圍，以便在綠色範圍及綠色加黑點範圍或任何毗鄰土地之內、之上或之下進行任何工程，包括但不限於鋪設及其後保養所有喉管、電線、管道、電纜槽及擬為該地段或任何毗鄰或相鄰土地或場所提供電話、電力、煤氣（如有）及其他服務設施所需的傳導媒介及附帶設備。承授人須就以上在綠色範圍及綠色加黑點範圍內進行的任何工程所有相關事宜，與政府及獲其正式授權的相關公用設施公司充分合作；及
(iii) 在水務監督的人員及彼等授權的其他人士要求時，批准水務監督的人員及彼等授權的其他人士有權通行、進出、往返及行經該地段、綠色範圍及綠色加黑點範圍，以便在綠色範圍及綠色加黑點範圍內進行任何有關任何其他水務設施的運作、保養、維修、更換及改動工程。
(b) 倘因政府、其人員、代理、承建商及根據本特別批地條款第(a)條獲授權的其他任何人士或公用設施公司行使權力，不論因處理或附帶之事宜而導致或令承批人或其他任何人士蒙受任何損失、損害、滋擾或騷擾，政府概不承擔任何責任。

12. Special Condition No.(9) of the Land Grant stipulates that:

- (a) (i) No structure or support for any structure shall be erected within the areas of drainage reserve shown coloured pink hatched black, pink hatched black stippled black and pink hatched black stippled black hatched green and marked "D.R." on PLAN I (hereinafter referred to as "the Drainage Reserve Area").
- (ii) Notwithstanding sub-clause (a)(i) of this Special Condition, with the prior written consent of the Director and subject to such terms and conditions as he may impose, the Grantee may erect or permit to be erected on the Drainage Reserve Area a minor structure or structures provided that if and when required by the Director, the Grantee shall at his own expense, within the period specified by and in all respects to the satisfaction of the Director, remove or demolish such structure or structures and reinstate the Drainage Reserve Area. If the Grantee fails to carry out such removal demolition or reinstatement works within the period specified or as required in an emergency, the Director may carry out such works as he may consider necessary and the Grantee shall pay to the Government on demand the cost of such works.
- (b) Notwithstanding the provisions contained in sub-clause (a) of this Special Condition, a building or buildings or any part thereof at first floor level and above may be erected or constructed over or above the Drainage Reserve Area provided that there is a clear space extending upwards from the ground level to a height of not less than 5.1 metres. For the purpose of this Special Condition, the decision of the Director as to what constitutes the ground level shall be final and binding upon the Grantee.
- (c) The Director and his duly authorized officers, contractors, his or their workmen (hereinafter collectively referred to as "the authorized persons") with or without tools, equipment, machinery or motor vehicles shall have the right of unrestricted ingress, egress and regress at all times to, from and through the lot for the purposes of laying, inspecting, repairing and maintaining drains, sewers, channels, drainage facilities and all other services running across, through or under the Drainage Reserve Area (hereinafter collectively referred to as "the Utilities") which the Director may require or authorize. No object or material of whatsoever nature which may obstruct access or cause excessive surcharge to the Utilities shall be placed within the Drainage Reserve Area. Where in the opinion of the Director (whose opinion shall be final and binding on the Grantee), there are objects or material within the Drainage Reserve Area which may obstruct access or cause excessive surcharge to the Utilities, the Director shall be entitled by notice in writing to call upon the Grantee, at his own expense and in all respects to the satisfaction of the Director, to demolish or remove such objects or material and to reinstate the Drainage Reserve Area. If the Grantee shall neglect or fail to comply with such notice within the period specified therein, or as required in an emergency the Director may carry out such removal demolition and reinstatement works as he may consider necessary and the Grantee shall pay to the Government on demand the cost of such works.
- (d) Save in respect of the reinstatement of any trench excavated in the exercise of the aforesaid rights and powers, the Government and the authorized persons shall have no liability in respect of any loss, damage, nuisance or disturbance whatsoever caused to or suffered by the Grantee arising out of or incidental to the exercise by the authorized persons of the right of unrestricted ingress, egress and regress and in laying, inspecting, repairing and maintaining the Utilities conferred under sub-clause (c) of this Special Condition and no claim shall be made against the Government or the authorized persons by the Grantee in respect of any such loss, damage, nuisance or disturbance.

13. Special Condition No.(10) of the Land Grant stipulates that:

- (a) The Grantee shall lay and form the primary school site area shown coloured pink hatched blue on PLAN I (hereinafter referred to as "the Pink Hatched Blue Area") on or before the 30th day of September, 2021 or within such other extended period or periods as may be approved by the Director at his own expense, in such manner, with such materials and to such standards, levels, alignment and design as the Director shall approve and in all respects to the satisfaction of the Director.
- (b) In the event of the non-fulfilment of the Grantee's obligations under sub-clause (a) of this Special Condition within the prescribed period stated therein, the Government may carry out the necessary works at the cost of the Grantee who shall pay to the Government on demand a sum equal to the cost thereof, such sum to be determined by the Director whose determination shall be final and binding upon the Grantee.

12. 批地文件特別批地條款第(9)條規定：

- (a) (i) 不得於批地文件所夾附圖則I內以粉紅色加斜黑線範圍、粉紅色加斜黑線加黑點範圍、粉紅色加斜黑線加黑點加斜綠線範圍及標記 "D.R." 顯示的排水專用範圍（以下稱「渠務專用範圍」）上興建任何結構物或任何結構物的支承件。
- (ii) 即使本特別批地條款第(a)(i)條之規定，如事前獲得署長書面同意及受制於署長制訂的該等條款與條件的情況下，承批人方可於渠務專用範圍興建或批准興建一個或多於一個小型結構物，惟倘及當署長要求，承批人須自費於署長指定期限內並令署長全面滿意移除或拆除此等結構物或多於一個結構物並恢復渠務專用範圍原狀。如承批人未能在指定期限內或按緊急情況所需進行上述移除、拆除及恢復工程，署長可進行必需的工程而承批人須在接獲通知時向政府支付有關工程的費用。
- (b) 即使本特別批地條款第(a)條所載，如渠務專用範圍地面層向上方伸延有不小於5.1米的淨高度空間，方可於渠務專用範圍一樓樓層及以上樓層之上或上方興建或建造一幢或多幢建築物或任何部份。就本特別批地條款而言，署長就何謂地面層作的決定將作為最終決定，並對承批人有約束力。
- (c) 署長及獲其授權的人員、承建商其或該等的工人（以下統稱「授權人士」）不論有否帶同工具、設備、器械或車輛，有權於所有時候不受限制通行、進出、往返及行經該地段，以便因應署長所要求或授權鋪設、視察、修理及保養貫穿，通過渠務專用範圍或其下的排水渠、污水渠、渠道、排水系統及其他系統（以下統稱「公共設施」）。任何可妨礙公共設施通路或引致其超出負擔的物件或物質（不論其性質）概不能放置於渠務專用範圍。在署長認為於渠務專用範圍存在物件或物質可妨礙公共設施通路或引致其超出負擔（其意見為最終的決定及對承批人具有約束力），署長有權以書面通知要求承批人於署長指明時限內，自費及令署長全面滿意拆卸和移除該等物件或物質及恢復渠務專用範圍原狀。如承批人忽視或未能於指定時段內遵從該通知，或按緊急情況所需，署長可進行其認為需要的該等拆卸、移除和復原工程而承批人須應政府要求向政府支付有關工程的費用。
- (d) 除必須恢復其行使上述權利和權力時挖掘的坑槽至原狀外，倘因授權人員行使本特別批地條款第(c)條的權利或其他情況而導致或令承批人或其他任何人士蒙受任何性質的損失、損害、滋擾或騷擾政府及授權人員概不承擔任何責任，及承批人不得就該等損失、損害、滋擾或騷擾而向政府或授權人員作出索償。

13. 批地文件特別批地條款第(10)條規定：

- (a) 承批人須在2021年9月30日或之前或署長批准的其他延長日期內，自費以署長批准的方式及物料，按署長批准的標準、水平、定線和設計並全面令署長滿意，鋪設及構造批地文件所夾附圖則I以粉紅色加斜藍線顯示的小學場地範圍（以下稱「粉紅色加斜藍線範圍」）。
- (b) 倘若承批人未能於所載日期內履行其在本特別批地條款第(a)條的義務，政府可進行必要的工程，費用一概由承批人負責，承批人並須應要求向政府支付相等於該等費用的金額，該金額由署長決定，其決定為最終決定及對承批人具有約束力。

- (c) The Government, the Director, his officers, contractors, his or their workmen and any other persons duly authorized by him shall have no liability in respect of any loss, damage, nuisance or disturbance whatsoever caused to or suffered by the Grantee or any other person whether arising out of or incidental to the fulfilment of the Grantee's obligations under sub-clause (a) of this Special Condition or the exercise of the rights by the Government, the Director, his officers, contractors, his or their workmen and any other persons duly authorized by him under sub-clause (b) of this Special Condition or otherwise, and no claim for compensation or otherwise shall be made against the Government or the Director or his officers, contractors, his or their workmen and any other persons duly authorized by him in respect of any such loss, damage, nuisance or disturbance.
14. Special Condition No.(11) of the Land Grant stipulates that:
The Grantee shall at all reasonable times prior to the surrender of the whole of the Pink Hatched Blue Area to the Government in accordance with Special Condition No.(12)(a) hereof permit the Director, his officers, contractors, his or their workmen and any other persons authorized by him, with or without tools, equipment, machinery or motor vehicles, the right of free and unrestricted ingress, egress and regress to, from and through the lot and the Pink Hatched Blue Area for the purpose of inspecting, checking and supervising any works to be carried out in compliance with Special Condition No.(10)(a) hereof and the carrying out, inspecting, checking and supervising of the works under Special Condition No.(10)(b) hereof and any other works which the Director may consider necessary in the Pink Hatched Blue Area.
15. Special Condition No.(12) of the Land Grant stipulates that:
(a) The Grantee shall at his own expense at any time or times when called upon to do so by the Director surrender to the Government and deliver up vacant possession of the Pink Hatched Blue Area or any part or parts thereof free from all incumbrances and without any consideration, payment or compensation whatsoever payable by the Government to the Grantee. For the purpose of this sub-clause, the Grantee shall at his own expense execute a deed or deeds of surrender and any other necessary documents in such form and containing such provisions as the Director shall approve or require.
(b) The Grantee shall not assign, mortgage, charge, demise, underlet, part with the possession of or otherwise dispose of or encumber the lot or any part or parts thereof or any interest therein or any building or buildings or part or parts of any building or buildings thereon or enter into any agreement so to do prior to the surrender of the Pink Hatched Blue Area to the Government pursuant to sub-clause (a) of this Special Condition unless and until the Grantee has at his own expense carved out the Pink Hatched Blue Area from the lot to the satisfaction of the Director, provided that this sub-clause (b) shall not apply to an assignment of the lot as a whole as provided under Special Condition No.(55) hereof or a building mortgage as provided in Special Condition No.(43)(d) hereof. Prior to the said carving out, the Grantee shall at his own expense submit the carving out document to the Director for his written approval.
16. Special Condition No.(13) of the Land Grant stipulates that:
The Grantee shall develop the lot by the erection thereon of a building or buildings complying in all respects with these Conditions and all Ordinances, bye-laws and regulations relating to building, sanitation and planning which are or may at any time be in force in Hong Kong, such building or buildings to be completed and made fit for occupation on or before the 30th day of September, 2024.
17. Special Condition No.(15) of the Land Grant stipulates that:
No tree growing on the lot or adjacent thereto shall be removed or interfered with without the prior written consent of the Director who may, in granting consent, impose such conditions as to transplanting, compensatory landscaping or replanting as he may deem appropriate.
- (c) 倘因承批人履行本特別批地條款第(a)條的義務或政府、署長、其人員、承建商、其或該等工人和根據本特別批地條款第(b)條或其他情況獲授權的其他任何人士行使權力，不論因處理或附帶之事宜而導致或令承批人或其他任何人士蒙受任何損失、損害、滋擾或騷擾，政府、署長、其人員、承建商、其或該等工人及獲授權的其他任人士概不承擔任何責任，及承批人不得就任何該等損失、損害、滋擾或騷擾向政府、署長、其人員、承建商、其或該等工人及獲授權的其他任人士作出索償賠償。
14. 批地文件特別批地條款第(11)條規定：
承批人須於按照本文特別批地條款第(12)(a)條完全歸還粉紅色加斜藍線範圍予政府前之任何時間內批准署長、其人員、承建商、其及該等工人及任何其他獲授權人士，不論有否帶同工具、設備、器械或車輛，有權自由及不受限制通行、進出、往返及行經該地段及粉紅色加斜藍線範圍，以便視察、檢查和監督根據本文特別批地條款第(10)(a)條進行的任何工程及進行、視察、檢查和監督根據本文特別批地條款第(10)(b)條的工程，以及任何於粉紅色加斜藍線範圍內，署長認為必要的其他任何工程。
15. 批地文件特別批地條款第(12)條規定：
(a) 承批人須自費並免卻任何產權負擔及無須政府向承批人支付任何性質的代價、償付或賠償的情況下，於任何時間應署長作出要求履行之時向政府歸還及移交粉紅色加斜藍線範圍或其任何一部份或多部份的空置管有權。就本特別批地條款而言，承批人須自費簽訂一份或多份土地歸還契約及任何採取署長批准或要求的格式並載明指定條款且必須之其他文件。
(b) 承批人不得於根據本特別批地條款第(a)條向政府歸還粉紅色加斜藍線範圍前轉讓、按揭、押記、批租、分租、放棄管有權或處置或妨礙該地段或其任何一部份或多部份或任何權益或其上任何一幢或多幢建築物或其任何一部份或多部份或簽署任何轉讓協議，除非直到承批人已自費從該地段分割出粉紅色加斜藍線範圍，並令署長滿意，本特別批地條款第(b)條並不適用於本文特別批地條款第(55)條所訂明的關於該地段整體轉讓的轉讓契約或根據本文特別批地條款第(43)(d)條所訂明的建築按揭。承批人須於該分割前，自費向署長遞交供其書面批核的分割文件。
16. 批地文件特別批地條款第(13)條規定：
承批人須發展該地段，興建於其上一幢或多幢全面遵從此等條款和目前或任何時間在香港生效的關於建築、衛生及規劃的所有條例、附例和規例的建築物，該一幢或多幢建築物須在2024年9月30日或之前建成並適宜佔用。
17. 批地文件特別批地條款第(15)條規定：
在該地段上或毗連的樹木，不得在未得到署長事先書面同意的情況下遭移除或受干擾。而署長在給予同意時，可以施加其認為合適的關於移植、補償性園景美化或重植的條款。

18. Special Condition No.(16) of the Land Grant stipulates that:

- (a) The Grantee shall submit or cause to be submitted to the Director for his approval a landscape master plan indicating the landscaping proposals for the lot.
- (b) The landscape master plan shall be at a scale of 1:500 or larger and shall contain information on the landscaping proposals including a survey and treatment of existing trees, site layout and formation levels, conceptual form of building development, illustrative layout of hard and soft landscaping areas and such other information as the Director may require. No superstructure work shall be commenced on the lot or any part thereof until the relevant submission has been approved in writing by the Director.
- (c) The Grantee shall at his own expense landscape the lot in accordance with the approved landscape master plan and no amendment, variation, alteration, modification or substitution shall be made without the prior written consent of the Director.
- (d) The Grantee shall thereafter at his own expense keep and maintain the landscaped works in a safe, clean, neat, tidy, functional and healthy condition all to the satisfaction of the Director.

19. Special Condition No.(17) of the Land Grant stipulates that:

Subject to these Conditions, upon development or redevelopment (which term refers solely to redevelopment contemplated in General Condition No.6 hereof) of the lot or any part thereof:

- (a) any building or buildings erected or to be erected on the lot shall in all respects comply with the Buildings Ordinance, any regulations made thereunder and any amending legislation;
- (b) no building or buildings may be erected on the lot or any part thereof or upon any area or areas outside the lot specified in these Conditions, nor may any development or use of the lot or any part thereof, or of any area or areas outside the lot specified in these Conditions take place, which does not in all respects comply with the requirements of the Town Planning Ordinance, any regulations made thereunder and any amending legislation;
- (c) (i) the total gross floor area of any building or buildings erected or to be erected on the lot shall not be less than 50,583 square metres and shall not exceed 84,306 square metres;
- (ii) of the total gross floor area specified in sub-clause (c)(i) of this Special Condition, the total gross floor area of the building or buildings erected or to be erected on the lot designed and intended to be used for private residential purpose shall not be less than 46,340 square metres and shall not exceed 77,234 square metres;
- (iii) of the total gross floor area specified in sub-clause (c)(i) of this Special Condition, the total gross floor area of the building or buildings erected or to be erected on the lot designed and intended to be used for non-industrial (excluding private residential, godown, hotel and petrol filling station) purposes shall not be less than 4,243 square metres and shall not exceed 7,072 square metres;
- (d) no part of any building or other structure erected or to be erected on the lot together with any addition or fitting (if any) to such building or structure may in the aggregate exceed a height of 163.45 metres above the Hong Kong Principal Datum, or such other height limit as the Director at his sole discretion may, subject to the payment by the Grantee of any premium and administrative fee as shall be determined by the Director, approve, provided that:
 - (i) with the prior written approval of the Director, machine rooms, air-conditioning units, water tanks, stairhoods and similar roof-top structures may be erected or placed on the roof of the building so as to exceed the above height limit; and
 - (ii) the Director at his sole discretion may in calculating the height of a building or structure exclude any structure or floor space referred to in Special Condition No.(64)(b)(i)(II) hereof;
- and
- (e) the design and disposition of any building or buildings erected or to be erected on the lot shall be subject to the approval in writing of the Director and no building works (other than site formation works) shall be commenced on the lot until such approval shall have been obtained. For the purpose of these Conditions "building works" and "site formation works" shall be as defined in the Buildings Ordinance, any regulations made thereunder and any amending legislation.

18. 批地文件特別批地條款第(16)條規定：

- (a) 承批人須提交或促使提交園景設計總圖予署長，述明該地段的園景美化建議，以供批核。
- (b) 園景設計總圖比例須為1：500或更大，並須載明園景美化建議資料，包括現有樹木普查及處理方案，地盤佈局和平整水平、建築發展概念模式，園景建築工程區及花卉樹木種植工程區圖解佈局，以及署長要求的其他資料。該地段或其任何部份不能展開任何上層結構工程，直至獲得署長對有關提交作出書面批核。
- (c) 承批人須自費按照經批核的園景設計總圖在該地段進行園景美化及如非事前獲署長書面同意，不得作任何修改、更改、改動、修訂或替代。
- (d) 承批人其後須自費保養和維修園景美化工程，以至於其安全、清潔、整齊、井然、有用及健康，全面令署長滿意。

19. 批地文件特別批地條款第(17)條規定：

受制於此等條款，如該地段或其任何部份進行發展或重新發展（上述兩詞純粹指本文一般批地條款第(6)條所載的重新發展項目）：

- (a) 現已或將會興建於該地段上的任何或多幢建築物必須全面遵從《建築物條例》、其任何附屬規例及任何修訂法例的規定；
- (b) 如在該地段上或其任何部份或此等條款所規定該地段外任何一個或多個範圍興建任何一幢或多幢建築物，又或發展或使用該地段或其任何部份，或此等條款規定的該地段外任何一個或多個範圍，必須全面遵從《城市規劃條例》、其任何附屬規例及任何修訂法例的規定，否則不得進行；
- (c) (i) 現已或將會興建於該地段上的任何一幢或多幢建築物的總樓面總面積須不少於50,583平方米及不超過84,306平方米；
- (ii) 本特別批地條款第(c)(i)條所載的總樓面總面積中，現已或將會興建於該地段設計作私人住宅用途的一幢或多幢建築物總樓面總面積須不少於46,340平方米及不超過77,234平方米；
- (iii) 本特別批地條款第(c)(i)條所載的總樓面總面積中，現已或將會興建於該地段設計及擬作非工業用途（不包括私人住宅、貨倉、酒店及加油站）的一幢或多幢建築物總樓面總面積須不少於4,243平方米及不超過7,072平方米；
- (d) 現已或將會興建於該地段上的任何建築物或其他結構物的任何部份連同有關建築物或結構物的任何加建物或裝置（如有）的總高度不可高於香港主水平基準163.45米或署長全權酌情批准的其他高度限制，而承批人須支付署長決定的任何地價和行政費用。然而：
 - (i) 在事前獲署長書面批准情況下，建築物天台可興建或放置超出上述高度限制的機房、冷氣機、水箱、梯屋及同類天台結構物；及
 - (ii) 署長憑其全權酌情決定可在計算建築物或結構物的高度時豁免本文特別批地條款第(64)(b)(i)(II)條所指的任何結構物或樓面空間；及
- (e) 任何現已或將會興建於該地段上的一幢或多幢建築物的設計和規劃須受制於署長書面批准，且在獲得批准前(除了地盤平整工程外)該地段上不可動土進行任何建築工程。於此等條款而言，「建築工程」及「地盤平整工程」將以《建築物條例》、其任何附屬規例及任何修訂法例訂明之釋義為準。

20. Special Condition No.(18) of the Land Grant stipulates that:

- (a) The Grantee shall at his own expense and in all respects to the satisfaction of the Director erect, construct and provide within the lot, in a good workmanlike manner and in accordance with the Technical Schedule annexed hereto (hereinafter referred to as "the Technical Schedule") and the plans approved under Special Condition No.(19)(a) hereof one public transport terminus on ground level/floor to be completed and made fit for occupation and operation on or before 84 calendar months from the date of this Agreement (which accommodation (including lighting fixtures, ventilation plant, extract ductworks and road/floor surfaces but excluding such lifts, escalators, stairways, plant, equipment and other facilities not serving exclusively thereto as may be permitted by the Director in accordance with these Conditions, walls, columns, beams, ceilings, roof slabs, carriageway/floor slabs and any other structural elements) together with any other areas, facilities, services and installations exclusive there to as the Director may in his absolute discretion determine (whose determination shall be conclusive and binding on the Grantee) are hereinafter collectively referred to as "the Government Accommodation"). Upon obtaining the prior written consent of the Director and subject to such conditions as the Director may impose from time to time, including the payment of additional premium and administrative fee all to be assessed by the Director at his discretion, the Grantee may at his cost and expense, at all times before the assignment referred to in Special Condition No.(24) hereof and the delivery of the vacant possession of the Government Accommodation or any part thereof referred to in Special Condition No.(26) hereof, use and occupy the Government Accommodation or any part or parts thereof for such purposes as the Director may approve and in all respects to the satisfaction of the Director, provided always that the Grantee shall indemnify, and keep indemnified the Government against all claims, costs, demands, charges, damages, actions and proceedings of whatsoever nature arising out of or in connection with the use and occupation of the Government Accommodation or any part or parts thereof.
- (b) The Government hereby reserves:
- (i) the right to alter or vary in its absolute discretion at any time the use of the Government Accommodation or any part thereof; and
 - (ii) the right to permit such persons as the Government may from time to time approve to use the Government Accommodation.
- (c) (i) For the purpose of determining the net operational floor area of any part of the Government Accommodation, the net operational floor area shall, unless otherwise stated, be taken as comprising the total of the net floor areas of all rooms and spaces within such part of the Government Accommodation as detailed in the Technical Schedule excluding any structures and partitions, circulation areas, staircases, staircase halls, lift landings, space occupied by toilet facilities, mechanical and electrical services such as lifts and air-conditioning systems.
- (ii) For the purpose of this Special Condition, the net floor area of a room or space shall be that area enclosed within the perimeter walls or boundaries of a room or space as measured between the finished or notional wall surfaces, free-standing columns or wall columns within that room or space.

21. Special Condition No.(19) of the Land Grant stipulates that:

- (a) (i) The Grantee shall submit or cause to be submitted to the Director for his written approval plans of the Government Accommodation which shall include details as to the level, position and design of the Government Accommodation and any other details as the Director may require.
 - (ii) Upon approval being given to the plans of the Government Accommodation, no amendment, variation, alteration, modification or substitution thereto shall be made by the Grantee except with the prior written approval of the Director or except as required by the Director.
 - (iii) The plans of the Government Accommodation approved under this sub-clause (a) shall be deemed to incorporate any amendment, variation, alteration, modification or substitution subsequently approved or required by the Director.
- (b) No building works other than site formation works shall be commenced on the lot until the plans of the Government Accommodation shall have been approved by the Director under sub-clause (a) of this Special Condition.

20. 批地文件特別批地條款第(18)條規定：

- (a) 承批人須自費以達至署長全面滿意的程度並以良好工藝方式，按照批地文件所夾附工程規格附表（以下稱「工程規格附表」）及根據本文特別批地條款第(19)(a)條已批核的圖則，在該地段內地面樓層上興建、建造和提供一個公共運輸交匯處，並於本協議簽定日起84個曆月時或前完成及達至適宜佔用及運作的程度（其處所（包括照明裝置、通風系統、抽風管道及道路/地面但不包括電梯、自動扶手電梯、樓梯、機器、設備及並不專屬於該處所而署長可根據此等條款批准的其他設施、牆壁、樁柱、基腳、天花板、屋頂面板、車行通道/地面平板及任何其他支承件）連同任何範圍、設施、服務及裝置均專屬該處而署長全權酌情決定（其決定為最終的決定及對承批人具有約束力）以下統稱「政府樓宇」）。在取得署長事前書面同意及遵照署長不時訂明的該等條款，包括額外地價及行政費用全由署長酌情決定，承批人可於自行承擔其費用的前提下，於根據本文特別批地條款第(24)條轉讓及交付根據本文特別批地條款第(26)條訂明的政府樓宇或其任何部份的空置管有權前的所有時間，使用和佔用政府樓宇或其任何部份，以用作署長批准及令署長全面滿意之該等用途，惟承批人須就使用或佔用政府樓宇或其任何一部份或多部份導致或產生的所有及任何性質的索償、費用、訴求、收費、損害、訴訟及其他法律程序向政府彌償，並確保其免責。
- (b) 政府現保留：
- (i) 其絕對酌情權利以在任何時候不時改動或更改政府樓宇或其任何部份的用途；及
 - (ii) 其權利以批准不時獲政府授權之人士使用政府樓宇。
- (c) (i) 就釐定政府樓宇任何部份的淨作業樓面面積而言，除非另有說明，否則淨作業樓面面積將視為包含工程規格附表詳列政府樓宇部份內所有房間及空間的淨樓面總面積，但不包括任何結構物及間隔、流通地方範圍、樓梯、樓梯大堂、電梯平台、廁所設備所佔用空間及電梯與空調系統等機電服務。
- (ii) 就本特別批地條款而言，個別房間或空間的淨樓面面積指該房間或空間圍牆或邊界圍牆內由該處已整飾或概念性牆壁表面、獨立柱或牆柱之間量度所得的面積。

21. 批地文件特別批地條款第(19)條規定：

- (a) (i) 承批人須向署長提交或促使提交政府樓宇的圖則以供其書面批核。該政府樓宇圖則須包括政府樓宇的水平、位置及設計詳情，以及署長要求的任何其他詳細資料。
 - (ii) 政府樓宇圖則獲批准後，除非事前獲署長書面批准或署長規定，否則承批人不得將其修改、更改、改動、修訂或替代。
 - (iii) 根據本特別批地條款第(a)條批核的政府樓宇圖則須被視作包含署長已批准或規定的修改、更改、改動、修訂或替代。
- (b) 署長根據本特別批地條款第(a)條規定批核政府樓宇圖則前，該地段上不可進行地盤平整工程以外的任何建築工程。

22. Special Condition No.(20) of the Land Grant stipulates that:
- The Director shall have the right to amend, vary, alter, modify or substitute the Technical Schedule as he shall in his absolute discretion deem fit.
 - No amendment, variation, alteration, modification or substitution to the Technical Schedule shall be made by the Grantee except with the prior written approval of the Director.
 - Any amendment, variation, alteration, modification or substitution by the Director under sub-clause (a) of this Special Condition or by the Grantee as approved by the Director under sub-clause (b) of this Special Condition shall be deemed to be incorporated into the Technical Schedule and form part thereof.
23. Special Condition No.(22) of the Land Grant stipulates that:
- The Director shall have the right in his absolute discretion to nominate officers of Government departments (hereinafter referred to as “the Officers”) who shall generally oversee the design, construction, provision and completion of the Government Accommodation and shall monitor the construction, provision and completion (hereinafter collectively referred to as “the Construction Works”) of the Government Accommodation in order to ensure that the Construction Works of the Government Accommodation are carried out in accordance with these Conditions.
 - The Grantee shall notify the Officers of any condition, restriction, requirement and information affecting or relating to the Government Accommodation or any part thereof or the Construction Works of the Government Accommodation or any part thereof forthwith upon the same becoming known to the Grantee, his servants, agents, contractors and workmen and shall make available all drawings, site records, notices, letters, certificates, approvals and information and render all necessary assistance and co-operation to the Officers when required by the Officers.
 - The Grantee shall keep the Director and the Officers advised from time to time as to when he shall be in a position to apply for the relevant Occupation Permit or Temporary Occupation Permit from the Building Authority in respect of the Government Accommodation or any part thereof.
 - The Government and the Director accept no responsibility or liability for any costs, claims, demands, charges, damages, actions or proceedings of whatsoever nature arising out of or in connection with the exercise by the Officers of the authority conferred under sub-clause (a) of this Special Condition.
 - The Grantee shall indemnify the Government and the Director from and against all liabilities, costs, expenses, claims, actions, demands and proceedings of whatsoever nature arising out of or in connection with the Construction Works of the Government Accommodation or any part thereof.
24. Special Condition No.(23) of the Land Grant stipulates that:
- Within 14 days after completion of the Government Accommodation or such part thereof, the Grantee shall deliver to the Director a certificate by an authorized person (as defined in the Buildings Ordinance, any regulations made thereunder and any amending legislation) employed by the Grantee for the development of the lot that the Government Accommodation or such part thereof has been completed in accordance with these Conditions.
 - Where in the opinion of the Director (whose decision in this respect shall be final and binding upon the Grantee) the Government Accommodation has been completed and made fit for occupation and operation to his satisfaction, the Director shall issue to the Grantee a certificate of completion to that effect provided that the Director may in his absolute discretion issue a certificate of completion in respect of a part of the Government Accommodation which the Director considers to have been completed and made fit for occupation and operation to his satisfaction.
 - Notwithstanding the issue of any certificate of completion by the Director, the Grantee shall not be absolved from any of his liabilities under Special Condition Nos.(22)(e) and (28) hereof nor any other obligations remaining to be observed and performed by him under these Conditions.
22. 批地文件特別批地條款第(20)條規定：
- 署長有權按其全權酌情視為恰當，修改、更改、改動、修訂或替代工程規格附表。
 - 除非事前獲得署長書面批准，承批人不可修改、更改、改動、修訂或替代工程規格附表。
 - 署長根據本特別批地條款第(a)條進行或承批人按照本特別批地條款第(b)條規定經署長批准進行的工程規格附表修改、更改、改動、修訂或替代項目，須被視作已納入工程規格附表並構成其一部份。
23. 批地文件特別批地條款第(22)條規定：
- 署長可全權酌情指定政府部門人員（以下稱「政府人員」）概括監管政府樓宇的設計、建造、裝配及完工，同時監察其建造裝配及完工情況（以下稱「建造工程」），以確保政府樓宇的建造工程按照此等條款進行實施。
 - 承批人就其知悉或其僱員、代理、承建商及工人知悉任何影響或關乎政府樓宇或其任何部份或政府樓宇或其部份建造工程的狀況、限制、規定及資料，必須即時通知政府人員，並須提供所有圖則、工地記錄、通知書、函件、證書、批准書及資料，並且在政府人員要求時提供所有必要支援和充分合作予政府人員。
 - 承批人須不時建議署長及政府人員其何時可向建築事務監督申領政府樓宇或其任何部份的相關佔用許可證或臨時佔用許可證。
 - 倘因政府人員行使本特別批地條款第(a)條的權力，不論因處理或附帶之事宜而導致任何費用、索償、訴求、收費、損害、訴訟及法律程序，政府及署長概不承擔任何責任或義務。
 - 承批人須就政府樓宇或其任何部份建造工程導致或產生的所有及任何性質的責任、費用、開支、索償、訴訟、訴求及法律程序向政府及署長彌償並確保其免責。
24. 批地文件特別批地條款第(23)條規定：
- 政府樓宇或有關部份落成後14日內，承批人須向署長提交由承批人就發展該地段所聘用之認可人士（釋義以《建築物條例》、其任何附屬規例及任何修訂法例所訂為準）簽發的證明書，證明已依照此等條款建成政府樓宇或該有關部份。
 - 如署長認為（其意見為最終的決定並對承批人有約束力）政府樓宇已以達其滿意建成並適合佔用及運作，便會就此向承批人發出完工證明書。然而，署長可全權酌情就其認為已達其滿意建成並適宜佔用和運作的政府樓宇部份簽發完工證明書。
 - 即使署長簽發完工證明書，本文特別批地條款第(22)(e)及(28)條訂明承批人須有的責任和此等條款指定其仍須履行及遵守的其他責任亦不會因此而被免除。

25. Special Condition No.(24) of the Land Grant stipulates that:

- (a) Notwithstanding anything to the contrary herein contained, the Grantee shall when called upon so to do by the Director assign to The Financial Secretary Incorporated a corporation sole incorporated under and by virtue of the Financial Secretary Incorporation Ordinance, any regulations made thereunder and any amending legislation (hereinafter referred to as "F.S.I." which expression shall if the context permits include its successors and assigns), with vacant possession, free from incumbrances, at the expense of the Grantee, the undivided shares specified in sub-clause (b) of this Special Condition together with the right to the exclusive use, occupation and enjoyment of the Government Accommodation and the Grantee shall complete the assignment of the Government Accommodation or any part thereof in respect of which a certificate of completion shall have been issued under Special Condition No.(23) hereof within such time or times as may be specified in writing by the Director. For the avoidance of doubt, the Grantee acknowledges that the Government shall be under no obligation to accept the assignment of the Government Accommodation or any part thereof at the request of the Grantee, but may do so as and when the Government sees fit.
- (b) The number of undivided shares in the whole of the lot to be assigned to F.S.I. in accordance with sub-clause (a) of this Special Condition shall be determined by the Director having regard to the proportion which the gross floor area of the Government Accommodation shall bear to the gross floor area of all the buildings erected or to be erected within the lot. The determination of the Director in this respect shall be final and binding upon the Grantee.
- (c) When called upon to do so by the Director (irrespective of whether the Grantee shall have been called upon to assign under sub-clause (a) of this Special Condition) the Grantee shall submit or cause to be submitted to the Director for his approval in writing an Assignment in respect of the Government Accommodation which Assignment shall be in such form and shall contain such provisions as shall be required or approved by the Director.
- (d) On completion of the assignment of the Government Accommodation or any part thereof the Grantee shall deliver to F.S.I. at the expense of the Grantee one set of the original or certified copies of deeds and documents of title relating to the lot and the Memorial of the Assignment in respect of the Government Accommodation or such part thereof duly completed and verified by the certificate of the solicitor for the Grantee. All fees payable on registration of the Assignment in the Land Registry shall be borne by the Grantee solely.

26. Special Condition No.(26) of the Land Grant stipulates that:

The Director shall have the right to demand at any time before the assignment of the Government Accommodation pursuant to Special Condition No.(24) hereof, delivery of vacant possession of the Government Accommodation or such part thereof as required by the Director in respect of which a certificate of completion shall have been issued under Special Condition No.(23) hereof and the Grantee shall upon such demand deliver the same to the Government for its exclusive use, occupation and operation upon such terms and conditions as the Director may consider appropriate.

27. Special Condition No.(27) of the Land Grant stipulates that:

- (a) Without prejudice to the provisions of Special Condition No.(28) hereof the Grantee shall, at all times before the assignment referred to in Special Condition No.(24) hereof and the delivery of the vacant possession of the Government Accommodation or any part thereof referred to in Special Condition No.(26) hereof and until expiry of the Defects Liability Period referred to in Special Condition No.(28)(a) hereof, at his own expense manage and maintain in good condition and in all respects to the satisfaction of the Director the Government Accommodation and the building services installations therefor.
- (b) For the purpose of this Special Condition only, the expression "Grantee" shall include the assignees whose title is derived from the Grantee under Special Condition No.(55) hereof, but otherwise exclude his assigns.

25. 批地文件特別批地條款第(24)條規定：

- (a) 即使本文另有相反規定，承批人須在署長作出要求時，自費及不帶任何產權負擔的形式，向根據《財政司司長法團條例》、其任何附屬規例及任何修訂法例成立為單一法團之「財政司司長法團」（以下稱「財政司司長法團」並如上下文意允許包括其繼承人及受讓人）轉讓本特別批地條款第(b)條所訂的不分割份數及空置管有權，以及使用、佔用和享用政府樓宇的專有權利，承批人須於署長書面指定的任何時間內完成轉讓已根據本文特別批地條款第(23)條獲發完工證明書的政府樓宇或其任何部份。為免存疑，承批人確認政府並無責任按承批人要求接受政府樓宇或其任何部份的轉讓，惟政府可於其認為適合時間下而進行。
- (b) 按本特別批地條款第(a)條轉讓予財政司司長法團的該地段整體內不分割份數數額將由署長根據政府樓宇總樓面面積佔現已或將會興建於該地段內所有建築物總樓面面積的比例釐定。署長的有關決定為最終的決定並對承批人有約束力。
- (c) 在署長作出要求時（不論承批人是否根據本特別批地條款第(a)條所訂被要求轉讓），承批人須向署長提交或促使提交有關政府樓宇的轉讓契約，以供署長書面批核。轉讓契約應採取署長指定或批准的格式並載明指定條款。
- (d) 政府樓宇或其任何部份的轉讓交易完成時，承批人須自費向財政司司長法團提交一套該地段契約及文件的正本或核證文本，以及由承批人律師填妥並以證明書核實的政府樓宇或其該部份的轉讓契約之註冊摘要。於土地註冊處註冊轉讓契約的所有應繳費用一律由承批人獨自承擔。

26. 批地文件特別批地條款第(26)條規定：

署長有權在根據本文特別批地條款第(24)條轉讓政府樓宇之前的任何時間要求交付已根據本文特別批地條款第(23)條發出完工證明書的政府樓宇或其署長規定之部份之空置管有權。承批人須於接獲要求時，將其交予政府，以供政府按照署長視為恰當的條款與條件專有使用、佔用及運作。

27. 批地文件特別批地條款第(27)條規定：

- (a) 茲毋損本文特別批地條款第(28)條之規定，承批人須在根據本文特別批地條款第(24)條轉讓政府樓宇之前及根據本文特別批地條款第(26)條交付政府樓宇或其任何部份之空置管有權前的所有時間，及直至本文特別批地條款第(28)(a)條訂明的保養期屆滿自費管理及保養政府樓宇和該處各建築物服務設置以保持其狀態良好達至署長全面滿意。
- (b) 就本特別批地條款而言，「承批人」一詞包括本文特別批地條款第(55)條所載的承讓人但不包括其受讓人。

28. Special Condition No.(28) of the Land Grant stipulates that:

- (a) The Grantee shall indemnify and keep indemnified the Government and F.S.I. against all claims, costs, demands, charges, damages, actions and proceedings of whatsoever nature arising out of or in connection with any defects, wants of repair, imperfections, breakdown, faults or any other outstanding works (whether in respect of workmanship, material, design or otherwise) in the Government Accommodation and in the building services installations therefor-
- (i) which may exist at the date of delivery of vacant possession by the Grantee of the Government Accommodation or any part thereof; and
- (ii) which shall occur or become apparent within a period of 365 days after the date of delivery of vacant possession by the Grantee of the Government Accommodation or any part thereof (hereinafter referred to as "Defects Liability Period").
- (b) Whenever required by the Director or F.S.I. or both, the Grantee shall at his own expense and within such time and to such standard and in such manner as may be specified by the Director or F.S.I. or both carry out all works of maintenance, repair, amendment, reconstruction and rectification and any other works as may be necessary to remedy and rectify any defects, wants of repair, imperfections, breakdown, faults or any other outstanding works in the Government Accommodation or any part thereof and the building services installations therefor which shall occur or become apparent within any Defects Liability Period. In addition to the foregoing, the Grantee shall at his own expense and within such time and to such standard and in such manner as may be specified by the Director or F.S.I. or both make good and rectify any defects, wants of repair, imperfections, breakdown, faults or any other outstanding works in the Government Accommodation or any part thereof and the building services installations therefor which may exist at the date of delivery of possession thereof by the Grantee.
- (c) The Director or F.S.I. or both will, shortly before the expiry of the Defects Liability Period, cause an inspection to be carried out in respect of the relevant part of the Government Accommodation and the building services installations therefor for the purpose of identifying any defects, wants of repair, imperfections, breakdown, faults or any other outstanding works which may be evident. The Director and F.S.I. reserve the right to each of them to serve upon the Grantee within 14 days after the expiry of the Defects Liability Period a Schedule or Schedules of Defects specifying any defects, wants of repair, imperfections, breakdown, faults or any other outstanding works which may be evident in the relevant part of the Government Accommodation and the building services installations therefor and the Grantee shall at his own expense cause all necessary works to be carried out so as to remedy and rectify the same within such time and to such standard and in such manner as may be specified by the Director or F.S.I. or both.
- (d) If the Grantee shall fail to carry out any of the works referred to in sub-clauses (b) and (c) of this Special Condition, then any such works may be carried out by the Government or F.S.I. or both and all costs and charges incurred in connection therewith by the Government or F.S.I. or both as certified by the Director (whose decision shall be final and binding upon the Grantee) together with a sum equivalent to 20 per centum of the costs and charges involved as an administrative fee shall on demand be paid by the Grantee.
- (e) The Grantee shall procure from its parent or other associated company as shall be determined by the Director at his absolute discretion a written guarantee whereby such company unconditionally and irrevocably-
- (i) guarantees the performance of obligations of the Grantee under this Special Condition No.(28); and
- (ii) indemnifies the Government and F.S.I. against all losses, damages, costs, charges, expenses and liabilities which may be incurred by the Government or F.S.I. or both by reason of or arising out of any breach or non-performance of any of the obligations of the Grantee under this Special Condition No.(28).

The guarantee shall be subject to the laws of Hong Kong in a form to be approved by the Director and shall be delivered to him within 30 days from the date of this Agreement or within such other extended period or periods as may be approved by the Director. If the Grantee has a parent or associated company incorporated outside of Hong Kong and if required by the Director or F.S.I. or both the Grantee shall procure and furnish to the Director a performance bond or guarantee in a form acceptable in all respects to the Director to be given by a bank licensed under section 16 of the Banking Ordinance. Such bond or guarantee shall be for such sum as the Director may decide (the decision of the Director to the sum shall be final and binding on the Grantee) for the purpose of securing payment to the Government or F.S.I. or both of any sum which shall have been demanded under sub-clause (d) of this Special Condition and has not been paid by the Grantee to the Government or F.S.I. or both.

28. 批地文件特別批地條款第(28)條規定：

- (a) 承批人須就政府樓宇及該處各建築服務設置如有任何下列缺點、失修、不善、故障、失靈或任何其他尚未完成工程（不論乃關乎做工、物料、設計或其他），而導致或產生的所有任何性質的索償、費用、訴求、收費、損害、訴訟及法律程序向政府及財政司司長法團彌償並確保其免責：
- (i) 於承批人交付政府樓宇或其任何部份之空置管有權當日已存在者；及
- (ii) 承批人交付政府樓宇或其任何部份空置管有權當日後365日內（以下稱「保養期」）出現或呈現者。
- (b) 如署長或財政司司長法團或兩者要求，承批人須自費在署長或財政司司長法團或兩者指定的日期內以其指定的標準及方式進行所有保養、維修、修改、重建及糾正工程和其他任何必要工程，以補救及糾正政府樓宇或其任何部份和該處各建築服務設置於保養期內出現或呈現的缺點、失修、不善、故障、失靈或其他尚未完成工程。除上述所指之外，承批人並須自費在署長或財政司司長法團或兩者指定的該日期內以其指定的標準及方式修復及糾正政府樓宇或其任何部份和該處各建築服務設置於承批人交付管有權日已存在的缺點、失修、不善、故障、失靈或任何其他尚未完成工程。
- (c) 保養期即將屆滿前，署長或財政司司長法團或兩者將促使進行檢驗相關政府樓宇部份和該處建築服務設置，以識別任何明顯的缺點、失修、不善、故障、失靈或任何其他尚未完成工程。署長和財政司司長法團各自保留權利於保養期屆滿後14日內向承批人送達一份或多份建築瑕疵細目表，列明相關政府樓宇部份及該處建築服務設置的明顯缺點、失修、不善、故障、失靈或任何其他尚未完成工程。承批人須自費促使所有必要工程進行，以於署長或財政司司長法團或兩者指定的日期內以其指定的標準及方式補救及糾正此等缺失。
- (d) 如承批人未能進行本特別批地條款第(b)及(c)條所訂的任何工程，政府或財政司司長法團或兩者可自行進行。承批人須於接獲通知後支付經署長核證（其決定為最終決定並對承批人有約束力）為署長或財政司司長法團或兩者因此招致的所有費用及收費，另加相等於費用及收費總額百分之20的行政費。
- (e) 承批人須達致其母公司或署長全權酌情指定的其他有聯繫公司發出擔保書，承諾該公司無條件及不可撤回地：
- (i) 擔保承批人履行本特別批地條款第(28)條的責任；及
- (ii) 就承批人任何違反或不履行本特別批地條款第(28)條所規定的任何責任而導致署長或財政司司長法團或兩者招致的所有損失、損害、費用、收費、開支及責任承批人須向政府及財政司司長法團彌償並確保其免責。

上述擔保書須遵從香港法律，並採用署長批准的格式，於本協議簽訂日30天或署長批准的其他一段或多段延長日期內交付署長。如承批人的母公司或有聯繫公司於香港境外註冊，又如署長或財政司司長法團或兩者要求，承批人須達致提交署長由根據《銀行業條例》第16條持牌的銀行簽發而格式全面符合署長要求的履約保證書或擔保書。該履約保證書或擔保書的金額為署長決定（其決定為最終決定並對承批人有約束力），用於確保向署長或財政司司長法團或兩者支付已根據本特別批地條款第(d)條發出通知應繳惟承批人尚未清繳予署長或財政司司長法團或兩者的任何款項。

(f) For the purpose of this Special Condition only, the expression "Grantee" shall include the assignees whose title is derived from the Grantee under Special Condition No.(55) hereof, but otherwise exclude his assigns.

29. Special Condition No.(29) of the Land Grant stipulates that:

The Grantee shall, at his own expense and as soon as practicable but no later than 8 weeks from the date of delivery of possession by the Grantee of the Government Accommodation, provide to the Director all documents, drawings and materials relating thereto in accordance with the requirement of the Technical Schedule.

30. Special Condition No.(30) of the Land Grant stipulates that:

(a) The Grantee shall throughout the term hereby agreed to be granted at his own expense and in all respects to the satisfaction of the Director maintain the following items (hereinafter referred to as "the Items"):-

- (i) the external finishes of the Government Accommodation and the structure of all walls, columns, beams, ceilings, roof slabs, carriageway/floor slabs and any other structural elements of, in, around, within, above and below the Government Accommodation;
- (ii) all lifts, escalators and stairways serving the Government Accommodation and the remainder of the development on the lot;
- (iii) all building services installations, plant and equipment (including but not limited to portable and non-portable fire services installation equipment) forming part of the system serving the Government Accommodation and the remainder of the development on the lot;
- (iv) all other common parts and facilities serving the Government Accommodation and the remainder of the development on the lot.

(b) The Grantee shall indemnify and keep indemnified the Government and F.S.I. against all liabilities, damages, expenses, claims, costs, demands, charges, actions and proceedings of whatsoever nature arising out of or as a consequence of the failure of the Grantee to maintain the Items.

(c) For the purpose of this Special Condition only, the expression "Grantee" shall exclude F.S.I..

31. Special Condition No.(31) of the Land Grant stipulates that:

(a) There are excepted and reserved unto the Government, its lessees, tenants, licensees and occupiers (hereinafter collectively referred to as "the Successors In Title") for the time being of the Mini Transport Interchange Reserved Area or any part thereof:

- (i) the rights of support and occupation over the lot at such positions, in such manner, with such materials and to such standards, levels, alignment and design as may be determined by the Director for the construction and maintenance of all supporting structures and connections to the mini transport interchange constructed or to be constructed within the Mini Transport Interchange Reserved Area, and the Grantee shall ensure that no structure or building within the lot will obstruct, interfere with or prejudice the construction or maintenance of any supporting structures or connections to the mini transport interchange;
- (ii) the rights of shelter support and protection from the lot for such parts of the Mini Transport Interchange Reserved Area as required, and such rights of shelter support and protection over the lot shall be as decided by the Director whose decision shall be final and binding on the Grantee;
- (iii) the right to enter upon the lot with or without tools, equipment, plant, machinery or motor vehicles for the purpose of connecting, constructing, inspecting, maintaining, repairing and renewing the mini transport interchange and the structures and installations supporting or appurtenant to the mini transport interchange;
- (iv) the rights of such easements, and rights of way through and over the lot and any buildings or structures erected or to be erected on the lot to and from the Mini Transport Interchange Reserved Area and any part or parts thereof and the structures and installation supporting or appurtenant to the Mini Transport Interchange Reserved Area as decided by the Director whose decision shall be final and binding on the Grantee; and
- (v) the rights of passage of gas, electricity, water, drainage or other effluent, air, telephone lines and other services to and from the Mini Transport Interchange Reserved Area and any part or parts thereof through any gutters, pipes, wires, cables, sewers, drains, ducts, flues, conduits and water courses and other conducting media laid or to be laid or running along, through, over, upon, under or in the lot or any buildings, structures and erections on the lot.

(f) 就本特別批地條款而言，「承批人」一詞包括本文特別批地條款第(55)條所載的承批人但不包括其受讓人。

29. 批地文件特別批地條款第(29)條規定：

承批人須於向政府交付政府樓宇的管有權日後在切實可行的時間內惟不遲於8星期內，自費向署長提交遵照工程規格附表規定所有的文件、圖則及材料。

30. 批地文件特別批地條款第(30)條規定：

(a) 承批人須在整個批地年期內，自費以達致署長全面滿意保養以下項目（以下稱「該等物件」）：

- (i) 政府樓宇的外飾面及政府樓宇之內、周圍、其中、其上及其下所有牆、柱、樑、天花、天台板、車道或地台板結構和任何其他結構項件；
- (ii) 所有供政府樓宇及該地段發展項目其餘部份使用的電梯、自動扶手電梯及樓梯；
- (iii) 構成供政府樓宇及該地段發展項目其餘部份的系統一部份的所有建築物服務設置、機器及設備（包括但不限於手提式及非手提式消防裝置設備）；
- (iv) 所有其他供政府樓宇及該地段發展項目其餘部份使用的公用部份及設施。

(b) 承批人須就其未能保養該等物件而導致或招致的所有及任何性質的責任、損害、開支、索償、費用、訴求、收費、訴訟及法律程序向政府及財政司司長法團彌償並確保其免責。

(c) 於本特別批地條款而言，「承批人」之釋義不包括財政司司長法團。

31. 批地文件特別批地條款第(31)條規定：

(a) 政府、其承租人、租客、持牌人及佔用人（以下統稱「所有權繼承人」）現獲例外保留小型交通運輸交匯處專用範圍或其任何部份：

- (i) 其權利從該地段，於署長決定的位置、方式、物料、標準、水平、定線及設計獲得支承與佔用，以便建造及保養於小型交通運輸交匯處專用範圍內現有或將會建造的小型交通運輸交匯處的所有支承結構物及連接物。承批人須確保該地段內沒有任何結構物或建築物對小型交通運輸交匯處的支承結構物或連接物的建造或保養構成干擾、妨礙或侵害；
- (ii) 其權利以於需要時從該地段獲得庇護、支承及保護小型交通運輸交匯處專用範圍及其該等部份，而此可從該地段獲庇護、支承及保護權利由署長決定而其決定為最終決定並對承批人有約束力；
- (iii) 其權利進入該地段，不論有否帶同工具、設備、機器、器械或車輛，以便連接、建造、視察、保養、修理及翻新小型交通運輸交匯處及其支承或從屬結構與裝置；
- (iv) 其權利享有該地段及現已或將會興建於該地段上任何建築物或結構物的所有必要地役權及通行權，以便往來小型交通運輸交匯處專用範圍及其任何一部份或多部份及其內各支承或從屬結構與裝置，而此權利由署長決定而其決定為最終決定並對承批人有約束力；
- (v) 其權利透過現時或往後鋪設於該地段或該地段上任何建築物、結構物及興建物或跟著、穿過、越過跨過或其下該處之任何溝渠、水管、電線、電纜、污水管、排水渠、管槽、排煙道、管道及水道和其他導體而享用接駁至小型交通運輸交匯處專用範圍及其任何部份的氣體、電力、水、污水或其他污水排放、空氣、電話線及其他服務。

- (b) Neither the Grantee nor any other person shall make objection to or have any right or claim to compensation against the Government whatsoever whether under any enactment or otherwise in respect of the exception and reservation under sub-clause (a) of this Special Condition or in respect of any liabilities, losses, damages, claims, costs, actions, demands and proceedings of whatsoever nature howsoever caused arising out of or as a consequence of the use of the Mini Transport Interchange Reserved Area as the mini transport interchange for vehicular traffic or otherwise.
- (c) The Government, its officers, agents, contractors and workmen or other duly authorized personnel shall have no liability in respect of any loss, damage, nuisance or disturbance whatsoever caused to or suffered by the Grantee or any other person arising out of or incidental to the exercise by it or them of the rights conferred under sub-clause (a) of this Special Condition or arising out of the maintenance, presence or operation of the mini transport interchange, and no claim shall be made against it or them by the Grantee in respect of any such loss, damage, nuisance or disturbance.
- (d) The Grantee acknowledges and agrees that the Government in no way warrants under this Special Condition that the mini transport interchange will be constructed in the future and shall be under no liability whatsoever to the Grantee for any loss or damage howsoever arising in connection therewith or as a consequence thereof if the mini transport interchange will not be constructed in the future.
- (e) Without prejudice to the rights of Government under Special Condition No.(31)(a) hereof, upon obtaining the prior written consent of the Director, the Grantee may at his cost and expense erect within the Mini Transport Interchange Reserved Area such walls and supporting structures for any building or structures erected or to be erected within the lot as the Director may approve from time to time, provided that:
- the Grantee shall at his cost and expense repair, maintain, replace, renew, remove and demolish such walls and supporting structures as the Director may from time to time require in his discretion whose decision is final and binding upon the Grantee, and
 - the Grantee shall indemnify, and keep indemnified the Government and the Successors In Title against all claims, costs, demands, charges, damages, actions and proceedings of whatsoever nature arising out of or in connection with the erection, repair, maintenance, replacement, renewal, removal and demolition of such walls and supporting structures.
32. Special Condition Nos.(33)(a)(c) of the Land Grant stipulate that:
- The Grantee may erect, construct and provide within the lot such recreational facilities and facilities ancillary thereto (hereinafter referred to as "the Facilities") as may be approved in writing by the Director. The type, size, design, height and disposition of the Facilities shall also be subject to the prior written approval of the Director.
 - In the event that any part of the Facilities is exempted from the gross floor area calculation pursuant to sub-clause (b) of this Special Condition (hereinafter referred to as "the Exempted Facilities"):
 - the Exempted Facilities shall be designated as and form part of the Common Areas referred to in Special Condition No.(45)(a)(vi) hereof;
 - the Grantee shall at his own expense maintain the Exempted Facilities in good and substantial repair and condition and shall operate the Exempted Facilities to the satisfaction of the Director; and
 - the Exempted Facilities shall only be used by the residents of the residential block or blocks erected or to be erected within the lot and their bona fide visitors and by no other person or persons.
33. Special Condition Nos.(34)(a)(c) of the Land Grant stipulate that:
- In the event of the lot or any part thereof being used for residential purpose, office accommodation for watchmen or caretakers or both may be provided within the lot subject to the following conditions:
 - such accommodation is in the opinion of the Director essential to the safety, security and good management of the residential building or buildings erected or to be erected on the lot;
 - such accommodation shall not be used for any purpose other than office accommodation for watchmen or caretakers or both, who are wholly and necessarily employed on the lot; and
 - the location of any such accommodation shall first be approved in writing by the Director.
 - Office accommodation provided within the lot in accordance with sub-clause (a) of this Special Condition shall be designated as and form part of the Common Areas referred to in Special Condition No.(45)(a)(vi) hereof.
- (b) 承批人或任何其他人士均不得就本特別批地條款第(a)條的例外保留權利，或就此或就著使用小型交通運輸交匯處專用範圍作車輛行使等用途之小型交通運輸交匯處所導致或招致的任何性質的責任、損失、損害、索償、費用、訴訟、訴求及法律程序，作出反對或向政府提出不論是否在任何法例下申索或索償。
- (c) 倘因政府、其人員、代理、承辦商及工人或其他獲授權人員或其一或多方行使本特別批地條款第(a)條權利或處理附帶於此等權利之事宜，或因小型交通運輸交匯處進行保養、其存在或運作令承批人或任何其他人士導致或產生任何損失、損害、滋擾或騷擾，政府、其人員、代理、承辦商及工人或其他獲授權人員概毋須就此承擔責任，承批人不得就任何此等損失、損害、滋擾或騷擾向彼等任何一方索償。
- (d) 承批人確認及同意政府概不憑藉本特別批地條款作出保證日後將會興建小型交通運輸交匯處。倘若日後不興建該小型交通運輸交匯處而因此導致承批人產生任何損失或損害，政府毋須就此承擔任何責任。
- (e) 茲毋損本文特別批地條款第(31)(a)條所賦予政府的權利，承批人可於獲得署長事先批准，自費於小型交通運輸交匯處專用範圍內興建任何現已或將會興建於該地段內經署長批准的建築物或結構物的牆壁及支承結構，惟須遵從以下條件：
- 承批人須於署長任何時間要求下自費維修、保養、更換、更新、移除、及拆卸該牆壁及支承結構，而署長的決定為最終決定並對承批人有約束力；及
 - 承批人須向政府及其所有權繼承人就因興建、維修、保養、更換、更新、移除、及拆卸該牆壁及支承結構而導致或產生任何性質之索償、費用、訴求、收費、損害、訴訟及法律程序作出彌償並確保其免責。
32. 批地文件特別批地條款第(33)(a)及(c)條規定：
- 承批人可於該地段內興建、建造及提供經署長書面批准的康樂設施及其附屬設施（以下稱「該等設施」）。該等設施的種類、大小、設計、高度及規劃亦須受制於事先取得署長書面批准。
 - 倘若該等設施的任何部份根據本特別批地條款第(b)條獲豁免計入總樓面面積之內（以下稱「獲豁免設施」）：
 - 獲豁免設施須被指定為並構成本文特別批地條款第(45)(a)(vi)條所指的公用地方之一部份；
 - 承批人須自費保養獲豁免設施，使其保持修葺良好堅固和狀況良好，並運作獲豁免設施，以令署長滿意；及
 - 獲豁免設施只可以供該地段內興建或擬興建的一幢或多幢住宅大廈的住客及彼等的真正訪客使用，任何其他人士不得使用。
33. 批地文件特別批地條款第(34)(a)及(c)條規定：
- 倘該地段或其他任何部份乃作住宅用途，則可於該地段內提供看更或管理員或兩者之辦公設施，但須受制於下列條款：
 - 署長認為該等設施對於現已或將會興建於該地段上一幢或多幢建築物的安全、保安及良好管理是必要的；
 - 該等設施不得用作該地段全職及有必要聘請的看更或管理員或兩者的辦公設施以外的任何用途；及
 - 任何該等設施的位置須事先經署長書面批准。
 - 根據本特別批地條款第(a)條在該地段內提供的辦公設施須被指定為並構成本文特別批地條款第(45)(a)(vi)條所指的公用地方之一部份。

34. Special Condition Nos.(35)(a)(c) of the Land Grant stipulate that:
- (a) In the event of the lot or any part thereof being used for residential purpose, quarters for watchmen or caretakers or both may be provided within the lot subject to the following conditions:
- (i) such quarters shall be located in one of the blocks of residential units erected on the lot or in such other location as may be approved in writing by the Director; and
- (ii) such quarters shall not be used for any purpose other than the residential accommodation of watchmen or caretakers or both, who are wholly and necessarily employed within the lot.
- For the purposes of this sub-clause (a), no quarters may be located within any building on the lot which is intended or adapted for use as a single family residence. The decision of the Director as to whether a building constitutes or is intended for use as a single family residence shall be final and binding on the Grantee.
- (c) Quarters for watchmen or caretakers or both provided within the lot in accordance with sub-clause (a) of this Special Condition shall be designated as and form part of the Common Areas referred to in Special Condition No.(45)(a)(vi) hereof.
35. Special Condition Nos.(36)(a)(c) of the Land Grant stipulate that:
- (a) In the event of the lot or any part thereof being used for residential purpose, one office for the use of the Owners' Corporation or the Owners' Committee may be provided within the lot provided that:
- (i) such office shall not be used for any purpose other than for meetings and administrative work of the Owners' Corporation or Owners' Committee formed or to be formed in respect of the lot and the buildings erected or to be erected thereon; and
- (ii) the location of any such office shall first be approved in writing by the Director.
- (c) An office provided within the lot in accordance with sub-clause (a) of this Special Condition shall be designated as and form part of the Common Areas referred to in Special Condition No.(45)(a)(vi) hereof.
36. Special Condition No.(37)(a) of the Land Grant stipulates that:
- (a) The Grantee shall at his own cost and expense and to the satisfaction of the Secretary for Education provide within the lot accommodation for a kindergarten comprising 6 classrooms, and other ancillary facilities having a total gross floor area of not less than 842 square metres, which kindergarten shall be operated by the Grantee in all respects to the satisfaction of the Secretary for Education, together with spaces for parking and for lay-by at the following rates and in accordance with the following conditions:
- (i) one space per every 6 classrooms each measuring 5.0 metres in length and 2.5 metres in width with a minimum headroom of 2.4 metres for the parking of motor vehicles licensed under the Road Traffic Ordinance, any regulations made thereunder and any amending legislation and belonging to the operators of the said kindergarten and their staff, bona fide guests, visitors or invitees; and
- (ii) one lay-by per every 8 classrooms or such other number as may be approved by the Director for the picking up and setting down of passengers from motor vehicles (including taxi) and another two lay-bys or such other number as may be approved by the Director for the picking up and setting down of passengers from school buses, both in such forms, of such dimensions, to such standards and at such locations as the Director may require or approve.
37. The Approval Letter further stipulates that under Special Condition No.(37)(a)(ii) of the Land Grant, a total of five lay-bys for the picking up and setting down of passengers from school buses, in such forms, of such dimensions, to such standards and at such locations as the Director may require or approve shall be provided within the lot in accordance with Special Condition No.(37)(a) of the Land Grant.
38. Special Condition No.(38) of the Land Grant stipulates that:
- (a) The Grantee shall at his own expense and in all respects to the satisfaction of the Director lay, form, provide, construct and surface such segregated pedestrian ways or paths (together with such stairs, ramps, lightings and escalators as the Director in his absolute discretion may require) for the purposes as specified in the sub-clause (b) of this Special Condition at such positions, in such manner, with such materials and to such standards, levels, alignment and designs as the Director shall approve.
34. 批地文件特別批地條款第(35)(a)及(c)條規定：
- (a) 倘該地段或其他任何部份乃作住宅用途，則可在該地段內提供看更或管理員或兩者的宿舍，但須受制於下列條款規限：
- (i) 該等宿舍須位於該地段上已興建的其中一幢住宅單位大廈或署長書面批准的其他位置；及
- (ii) 該等宿舍不得用作該地段全職及有必要聘請的看更或管理員或兩者的住所以外的任何用途。
- 就本特別批地條款第(a)條而言，宿舍不得設置在該地段上任何擬用作或經改裝以用作一戶家庭的住所的建築物內。署長就一建築物是否為或擬用作一戶家庭的住所所作決定為最終決定，並對承批人具有約束力。
- (c) 根據本特別批地條款第(a)條在該地段內提供的看更或管理員宿舍須被指定為並構成本文特別批地條款第(45)(a)(vi)條所指的公用地方之一部份。
35. 批地文件特別批地條款第(36)(a)及(c)條規定：
- (a) 倘該地段或其他任何部份乃作住宅用途，則可在該地段內提供業主立案法團或業主委員會使用的一個辦事處，惟：
- (i) 該辦事處不得用作為該地段及現已或將會興建於其上的建築物而成立的業主立案法團或業主委員會的會議及行政工作以外的任何用途；及
- (ii) 該辦事處的位置須事先經署長書面批准。
- (c) 根據本特別批地條款第(a)條在該地段內提供的辦事處須被指定為並構成本文特別批地條款第(45)(a)(vi)條所指的公用地方之一部份。
36. 批地文件特別批地條款第(37)(a)條規定：
- (a) 承批人須自費在該地段內提供令教育局局長滿意一間包含6個課室及其他輔助設施的幼稚園處所，其總樓面總面積不小於842平方米，且須按教育局局長全面滿意由承批人運作，並按照以下配置比率提供車位以供停泊及上落，及符合以下條款：
- (i) 每6個課室提供一個5.0米長、2.5米闊、最小淨空高度2.4米的車位，以供停泊屬於該幼稚園營運者、其員工、彼等之真正賓客、訪客或獲邀請人士根據《道路交通條例》、其任何附屬規例及任何修訂法例持牌的車輛；及
- (ii) 每8個課室提供一個或署長批准之數量的停車處供車輛（包括計程車）上落乘客及另外兩個或署長批准之數量的停車處供校巴上落乘客，各均按照署長要求或批准的形式、尺寸、標準及位置而提供。
37. 批准信再作規定按批地文件特別批地條款第(37)(a)(ii)條須根據批地文件特別批地條款第(37)(a)條按照署長要求或批准的形式、尺寸、標準及位置於該地段內提供五個供校巴上落乘客的停車處。
38. 批地文件特別批地條款第(38)條規定：
- (a) 承批人須自費按署長批准的該位置、方式、物料、標準、水平、定線和設計並全面令署長滿意，於該地段鋪設、構造、提供、建造和平整路面分段行人路或行人道（連同署長全權酌情要求的樓梯、斜路、照明裝置及自動扶手電梯），以作本特別批地條款第(b)條指明的用途。

- (b) The segregated pedestrian ways or paths referred to in sub-clause (a) of this Special Condition shall follow the shortest possible routes and shall be covered and constructed and designed so as to:
- link up each and every building to be erected on the lot at such locations and levels of the building as the Director shall approve; and
 - link up all major facilities within the lot including the shops, residential blocks, open space and community facilities provided thereon.
- (c) The Grantee shall throughout the whole term hereby agreed to be granted maintain at his own expense the segregated pedestrian ways or paths (together with such stairs, ramps, lightings and escalators) required to be provided under this Special Condition in good and substantial condition and repair to the satisfaction of the Director.
- (d) The Grantee shall on or before the date specified in Special Condition No.(13) hereof (or within such other date or extended period as may be approved by the Director) at his own expense and in all respects to the satisfaction of the Director, at such locations, levels, routing and alignment, in such manner and design, with such materials, to such standard and in such stages as may be approved by the Director, construct and provide within the lot a pedestrian walkway with a minimum clear width of 3 metres together with such escalators, stairways, ramps, lifts and such other associated structures as may be approved or required by the Director (hereinafter referred to as "the Pedestrian Walkway") for the purposes of linking up the public roads and footpaths adjoining or near the lot, the Government Accommodation, mini transport terminus (if any) and future adjoining development (if any) on the south-eastern side of the lot.
- (e) The Grantee shall throughout the term hereby agreed to be granted maintain at his own expense the Pedestrian Walkway in good and substantial condition and repair to the satisfaction of the Director.
- (f) The Grantee shall throughout the whole term hereby agreed to be granted at all times during day and night or such other hours as may be approved by the Director keep the Pedestrian Walkway open for use by the public free of charge without any interruption.
39. Special Condition No.(39) of the Land Grant stipulates that:
The Grantee shall on or before the date specified in Special Condition No.(13) hereof or such other extended period as may be approved by the Director at his own expense, with such materials and to such standards, levels, alignment, disposition and design as shall be required or approved by the Director (including but not limited to the provision and construction of such supports, ramps, associated staircases and landings, escalators, lifts and such internal and external fittings and fixtures and such lighting fittings as the Director in his sole discretion may require) provide and construct such supports and connections within the lot and the building or buildings erected or to be erected thereon between the points R and S shown and marked on PLAN I or such other points and at such levels as the Director may require.
40. Special Condition No.(47) of the Land Grant stipulates that:
The Grantee shall have no right of ingress or egress to or from the lot for the passage of motor vehicles except first between the points X and Y through Z shown and marked on PLAN I and, secondly, between U and V through W shown and marked on PLAN I or at such other points as may be approved in writing by the Director. Upon development or redevelopment of the lot, a temporary access for construction vehicles into the lot may be permitted in such position and subject to such conditions as may be imposed by the Director. Upon completion of the development or redevelopment, the Grantee shall at his own expense within the time limit specified by the Director and in all respects to the satisfaction of the Director, reinstate the area or areas upon which the temporary access was constructed.
41. The Approval Letter further stipulates that under Special Condition No.(47) of the Land Grant, the ingress and egress to and from the lot for the passage of motor vehicles shall be between the points U and V through W shown and marked on Plan No.STM10402a annexed to the Approval Letter, provided that with effect from the date of the Approval Letter, the right of ingress and egress to and from the lot for the passage of motor vehicles between the points U and V through W shown and marked on Plan No.ST3992-D1b annexed to the Land Grant is no longer allowed.
- (b) 本特別批地條款第(a)條所指的分段行人路或行人道須採取最短路線並含上蓋，建造及設計應符合以下要求：
- 於署長批准的位置和建築物的水平連通將會興建於該地段上每幢建築物；及
 - 連通該地段內所有主要設施，包括商業樓宇、住宅大廈、開放空間及社區設備。
- (c) 承批人須在本文協定的整個批地年期內自費保養本特別批地條款規定其提供的分段行人路或行人道（連同該處之樓梯、斜路、照明裝置及自動扶手電梯），以保持其修葺良好堅固和狀況良好令署長滿意。
- (d) 承批人須於本文特別批地條款第(13)條所訂明的日期或之前（或署長批准的該其他日期或延長日期內）自費按照署長批准的位置、水平、路線、定線，以及該方式、設計、物料、標準及階段，建造及提供最小淨闊度3米的行人走道，連同該處之自動扶手電梯、樓梯、斜路、電梯及其他由署長批准或要求的附屬結構（以下稱「行人走道」），以連接毗鄰或該地段附近的公共道路及行人路、政府樓宇、小型公共運輸交匯處（如有）及將來毗鄰該地段東南方的發展項目（如有）。
- (e) 承批人須於本文協定的整個批地年期內自費保養行人走道，以保持其修葺良好堅固和狀況良好令署長滿意。
- (f) 承批人須於本文協定的批地年期內的所有時間於日與夜或署長批准的該等其他時間內保持行人走道開放予公眾免費使用且不受任何中斷。
39. 批地文件特別批地條款第(39)條規定：
承批人須在本文特別批地條款第(13)條所訂明的日期或之前或署長批准的其他延長日期，自費以署長批准的物料、標準、水平、定線、布局及設計（包括但不限於署長全權酌情要求提供及建造支承件、斜路、相關的樓梯及平台、自動扶手電梯、電梯及內外配件及固定裝置與照明裝置）於該地段及現已有或將會興建的一幢或多幢建築物提供及建造支承件及連接點以連接批地文件所夾附圖則I所標示的R點和S點或其他由署長要求的地點及水平。
40. 批地文件特別批地條款第(47)條規定：
除通過第一，批地文件所夾附圖則I所顯示及標記的X及Y點之間的Z點和第二，批地文件所夾附圖則I所顯示及標記的U及V點之間的W點或署長書面批准的其他地點外，承批人無權以車輛進出該地段。如該地段進行發展或重新發展，建築工程的車輛可獲批准使用署長指定位置的臨時通道，但須受制於署長施加的條款。當完成發展或重新發展，承批人須自費於署長指定的時限內將臨時通道的一個或多個範圍恢復原狀，以令署長全面滿意。
41. 批准信再作規定按批地文件特別批地條款第(47)條車輛須於批准信所夾附圖則號碼STM10402a所顯示及標記的U及V點之間的W點進出該地段，然而於批准信日期起生效，車輛不再被准許於批地文件所夾附圖則號碼ST3992-D1b所顯示及標記的U及V點之間的W點進出該地段。

42. Special Condition No.(48) of the Land Grant stipulates that:

- (a) (i) Spaces shall be provided within the lot to the satisfaction of the Director for the parking of motor vehicles licensed under the Road Traffic Ordinance, any regulations made thereunder and any amending legislation, and belonging to the residents of the residential units in the building or buildings erected or to be erected on the lot and their bona fide guests, visitors or invitees (herein after referred to as "the Residential Parking Spaces") at a rate to be calculated by reference to the respective size of the residential units erected or to be erected on the lot as set out in the table below (unless the Director consents to a rate for or to a number of Residential Parking Spaces different from those set out in the table below):

Size of each residential unit	No. of the Residential Parking Spaces to be provided
Not less than 40 square metres but less than 70 square metres	One space for every 9.4 residential units or part thereof
Not less than 70 square metres but less than 100 square metres	One space for every 3.8 residential units or part thereof
Not less than 100 square metres but less than 160 square metres	One space for every 1.9 residential units or part thereof
Not less than 160 square metres	One space for one residential units

(ii) For the purpose of sub-clause (a)(i) of this Special Condition, the total number of Residential Parking Spaces to be provided shall be the aggregate of the respective number of the Residential Parking Spaces calculated by reference to the respective size of each residential unit set out in the table in sub-clause (a)(i) of this Special Condition. For the purpose of these Conditions, the term "size of each residential unit" in terms of gross floor area shall mean the sum of (I) and (II) below:

- (I) the gross floor area in respect of a residential unit, exclusively used and enjoyed by the resident of that unit, which shall be measured from the exterior of the enclosing walls or parapet of such unit except where such enclosing walls separate two adjoining units in which case the measurement shall be taken from the middle of those walls, and shall include the internal partitions and columns within such unit, but, for the avoidance of doubt, shall exclude all floor area within such unit which are not taken into account for the calculation of gross floor area stipulated in sub-clause (c) of Special Condition No.(17) hereof; and
- (II) the pro-rata gross floor area of Residential Common Area (as hereinafter defined) in respect of a residential unit. In so calculating, the total gross floor area of residential common area, which is for common use and benefit of all residents of the residential portion of the development erected or to be erected on the lot, outside the enclosing walls of the residential units but, for the avoidance of doubt, excluding all floor area which are not taken into account for the calculation of the gross floor area stipulated in sub-clause (c) of Special Condition No.(17) hereof (which residential common area is hereinafter referred to as the "Residential Common Area") shall be apportioned to a residential unit by the following formula:

$$\text{The total gross floor area of Residential Common Area} \times \frac{\text{The gross floor area in respect of a residential unit as calculated under sub-clause (a)(ii)(I) of this Special Condition}}{\text{The total gross floor area of all residential units as calculated under sub-clause (a)(ii)(I) of this Special Condition}}$$

(iii) Additional spaces for the parking of motor vehicles licensed under the Road Traffic Ordinance, any regulations made thereunder and any amending legislation, and belonging to the bona fide guests, visitors or invitees of the residents of the residential units in the building or buildings erected or to be erected on the lot shall be provided, subject to a minimum of two spaces being provided, at the following rates:

- (I) if more than 75 residential units are provided in any block of residential units erected or to be erected on the lot, at a rate of five spaces for every block of residential units, or
- (II) at such other rates as may be approved by the Director.

42. 批地文件特別批地條款第(48)條規定：

- (a) (i) 該地段內須提供署長滿意的車位，以供停泊根據《道路交通條例》、其任何附屬規例及任何修訂法例持牌而屬於現已或將會興建於該地段上一幢或多幢建築物中住宅單位的住客和彼等真正賓客、訪客或獲邀請人士的車輛（以下稱「住宅停車位」），並應根據下表所列現已或將會興建於該地段上各住宅單位的大小計算的配置比率配置（除非署長同意有別於下表所列的其他配置比率則屬例外）：

每個住宅單位的大小	擬提供住宅停車位數額
不少於40平方米但少於70平方米	每9.4個住宅單位或不足此數一個車位
不少於70平方米但少於100平方米	每3.8個住宅單位或不足此數一個車位
不少於100平方米但少於160平方米	每1.9個住宅單位或不足此數一個車位
不少於160平方米	每1個住宅單位一個車位

(ii) 就本特別批地條款第(a)(i)條而言，配置的住宅停車位總數須根據本特別批地條款第(a)(i)條中列表所載每個住宅單位面積計算的住宅停車位數額之總和。就此等批地條款而言，關於總樓面面積的「每個住宅單位大小」一詞指以下(I)與(II)之和：

- (I) 每個由該單位住客專用及專享的住宅單位之總樓面面積，須由該單位圍牆或矮牆外側開始量度，除非圍牆是分隔兩個毗鄰單位則例外並於該情況下，須由牆中央點開始量度，及須一併量度單位內的內部間隔牆及柱。但為免存疑，不包括單位內的所有於計算本文特別批地條款第(17)(c)條訂明的總樓面面積時不會連計在內的所有樓面面積；及
- (II) 個別住宅單位按比例分攤的住宅公用地方（釋義以下文所訂）總樓面面積，即計算每個住宅單位負責圍牆以外供現已或將會興建於該地段上發展項目中住宅部份供所有住客公用與共享的住宅公用地方之總樓面總面積。但為免存疑，不包括單位內所有於計算本文特別批地條款第(17)(c)條訂明的總樓面面積時不會連計在內的所有樓面面積（該住宅公用地方以下稱「住宅公用地方」），並依照下列程式按比例分攤予每個住宅單位：

$$\text{住宅公用地方總樓面總面積} \times \frac{\text{個別住宅單位依照本特別批地條款第(a)(ii)(I)條計算之總樓面面積}}{\text{所有住宅單位依照本特別批地條款第(a)(ii)(I)條計算之總樓面總面積}}$$

(iii) 須提供額外車位，以供停泊根據《道路交通條例》、其任何附屬規例及任何修訂法例持牌而屬於現已或將會興建於該地段上一幢或多幢建築物中住宅單位的住客的彼等真正賓客、訪客或獲邀請人士的車輛，配置比率如下惟最少須設有2個車位：

- (I) 如現已或將會興建於該地段上任何的一幢住宅單位大廈設有超過75個住宅單位，配置5個車位；或
- (II) 採用署長批准的其他比率。

- (iv) The spaces provided under sub-clauses (a)(i) (as may be adjusted pursuant to Special Condition No.(50) hereof) and (a)(iii) of this Special Condition shall not be used for any purpose other than those respectively set out in sub-clauses (a)(i) and (a)(iii) of this Special Condition and in particular the said spaces shall not be used for the storage, display or exhibiting of motor vehicles for sale or otherwise or for the provision of car cleaning and beauty services.
- (b) (i) Spaces shall be provided within the lot to the satisfaction of the Director for the parking of motor vehicles licensed under the Road Traffic Ordinance, any regulations made thereunder and any amending legislation at the following rates unless the Director consents to another rate:
- (I) one space for every 200 square metres or part thereof of the gross floor area of the building or buildings erected or to be erected on the lot to be used for office purpose; and
- (II) one space for every 200 square metres or part thereof of the gross floor area of the building or buildings erected or to be erected on the lot to be used for non-industrial (excluding private residential, office, godown, hotel and petrol filling station) purposes.
- (ii) For the purpose of calculating the number of spaces to be provided under sub-clauses (b)(i)(I) and (b)(i)(II) of this Special Condition, any floor area to be used for parking, loading and unloading purposes shall be excluded.
- (iii) The spaces provided under sub-clauses (b)(i)(I) and (b)(i)(II) of this Special Condition shall not be used for any purpose other than for the parking of motor vehicles licensed under the Road Traffic Ordinance, any regulations made thereunder and any amending legislation, and belonging to the occupiers of the building or buildings erected or to be erected on the lot for the respective purposes stipulated in the said sub-clauses and their bona fide guests, visitors or invitees and in particular the said spaces shall not be used for the storage, display or exhibiting of motor vehicles for sale or otherwise, or for the provision of car cleaning and beauty services.
- (c) (i) Out of the spaces provided under sub-clauses (a)(i) (as may be adjusted pursuant to Special Condition No.(50) hereof), (a)(iii), (b)(i)(I) and (b)(i)(II) of this Special Condition, the Grantee shall reserve and designate such number of spaces for the parking of motor vehicles by disabled persons as defined in the Road Traffic Ordinance, any regulations made thereunder and any amending legislation (which spaces to be so reserved and designated are hereinafter referred to as "the Parking Spaces for the Disabled Persons") as the Building Authority may require and approve provided that a minimum of one space shall be so reserved and designated out of the spaces provided under sub-clause (a)(iii) of this Special Condition and that the Grantee shall not designate or reserve all of the spaces provided under sub-clause (a)(iii) of this Special Condition to become the Parking Spaces for the Disabled Persons.
- (ii) The Parking Spaces for the Disabled Persons shall not be used for any purpose other than for the parking of motor vehicles by disabled persons as defined in the Road Traffic Ordinance, any regulations made thereunder and any amending legislation, and belonging to the residents of the building or buildings erected or to be erected on the lot and their bona fide guests, visitors or invitees and in particular the said spaces shall not be used for the storage, display or exhibiting of motor vehicles for sale or otherwise or for the provision of car cleaning and beauty services.
- (d) (i) Spaces shall be provided within the lot to the satisfaction of the Director for the parking of motor cycles licensed under the Road Traffic Ordinance, any regulations made thereunder and any amending legislation, at the following rates unless the Director consents to another rate:
- (I) 10 percent of the total number of Residential Parking Spaces required to be provided under sub-clause (a)(i) of this Special Condition (hereinafter referred to as "the Residential Motor Cycle Parking Spaces")(as may be adjusted pursuant to Special Condition No.(50) hereof);
- (II) 10 percent of the total number of spaces required to be provided under sub-clause (b)(i)(1) of this Special Condition; and
- (III) 10 percent of the total number of spaces required to be provided under sub-clause (b)(i)(II) of this Special Condition;
- provided that if the number of spaces to be provided is a decimal number, the same shall be rounded up to the next whole number.
- (ii) The Residential Motor Cycle Parking Spaces shall not be used for any purpose other than for the parking of motor cycles licensed under the Road Traffic Ordinance, any regulations made thereunder and any amending legislation, and belonging to the residents of the residential units in the building or buildings erected or to be erected on the lot and their bona fide guests, visitors or invitees and in particular the said spaces shall not be used for the storage, display or exhibiting of motor vehicles for sale or otherwise or for the provision of car cleaning and beauty services.
- (iv) 根據本特別批地條款第(a)(i)條提供的車位（可根據本文特別批地條款第(50)條調整）及本特別批地條款第(a)(iii)條提供的車位，除作本特別批地條款(a)(i)及(a)(iii)條分別所訂明的用途外，不可作任何其他用途，其中特別不可在車位上存放、陳列或展示車輛作招售等用途或提供洗車及汽車美容服務。
- (b) (i) 該地段內須提供署長滿意的車位，以供停泊根據《道路交通條例》、其任何附屬規例及任何修訂法例持牌的車輛，除非署長同意其他配置比率，否則配置比率如下：
- (I) 該地段上現已或將會興建作為寫字樓用途的一幢或多幢建築物每200平方米的總樓面面積或不足此數提供1個車位；及
- (II) 該地段上現已或將會興建作非工業用途（不包括私人住宅、寫字樓、貨倉、酒店及加油站）的一幢或多幢建築物每200平方米的總樓面面積或不足此數提供1個車位。
- (ii) 就計算本特別批地條款第(b)(i)(I)及(b)(i)(II)條提供的車位數目而言，任何作泊車及上落客貨之用的車位將不會列入計算樓面面積。
- (iii) 根據本特別批地條款第(b)(i)(I)及(b)(i)(II)條提供的車位除供停泊根據《道路交通條例》、其任何附屬規例及任何修訂法例持牌而屬於現已或將會興建於該地段上用作該等條款所訂明的用途的一幢或多幢建築物的佔用人及彼等真正賓客、訪客或獲邀請人士的車輛外，不可作任何其他用途，其中特別不可在車位上存放、陳列或展示車輛作招售等用途或提供洗車及汽車美容服務。
- (c) (i) 承批人應遵照建築事務監督之規定和批准，在根據本特別批地條款第(a)(i)（可根據本文特別批地條款第(50)條調整）、(a)(iii)、(b)(i)(I)及(b)(i)(II)條提供的車位中預留及劃出部份車位供根據《道路交通條例》、其任何附屬規例及任何修訂法例界定釋義的傷殘人士停泊車輛（此等預留及劃出的車位下稱「傷殘人士停車位」），並根據本特別批地條款第(a)(iii)條提供的車位最少須預留及劃出1個車位。惟承批人不得將所有根據本特別批地條款第(a)(iii)條提供的車位預留或劃為傷殘人士停車位。
- (ii) 傷殘人士停車位除供根據《道路交通條例》、其任何附屬規例及任何修訂法例界定釋義的傷殘人士停泊屬於現已或將會興建於該地段的一幢或多幢建築物的住客及彼等真正賓客、訪客或獲邀請人士的車輛外，不可作任何其他用途，其中特別不可在車位上存放、陳列或展示車輛作招售等用途或提供洗車及汽車美容服務。
- (d) (i) 該地段內須提供署長滿意的車位，以供停泊根據《道路交通條例》、其任何附屬規例及任何修訂法例持牌的電單車，除非署長同意其他配置比率，否則配置比率如下：
- (I) 本特別批地條款(a)(i)條提供的住宅停車位之總額百分之10（以下稱「住宅電單車停車位」）（可根據本文特別批地條款第(50)條調整）；
- (II) 本特別批地條款(b)(i)(I)條規定提供的停車位之總額百分之10；及
- (III) 本特別批地條款(b)(i)(II)條規定提供的停車位之總額百分之10；
- 惟若提供的停車位數額為小數位數，則四捨五入進位至最近的整數。
- (ii) 住宅電單車停車位除供停泊根據《道路交通條例》、其任何附屬規例及任何修訂法例持牌而屬於現已或將會興建於該地段上一幢或多幢建築物中住宅單位的住客和彼等真正賓客、訪客或獲邀請人士的電單車外，不可作任何其他用途，其中特別不可在車位上存放、陳列或展示車輛作招售等用途或提供洗車及汽車美容服務。

- (iii) The spaces provided under sub-clauses (d)(i)(II) and (d)(i)(III) of this Special Condition shall not be used for any purpose other than for the parking of motor cycles licensed under the Road Traffic Ordinance, any regulations made thereunder and any amending legislation and belonging to the occupiers of the building or buildings erected or to be erected on the lot and their bona fide guests, visitors or invitees for the respective purposes stipulated in sub-clauses (b)(i)(I) and (b)(i)(II) of this Special Condition and in particular the said spaces shall not be used for the storage, display or exhibiting of motor vehicles for sale or otherwise or for the provision of car cleaning and beauty services.
- (e) Spaces shall be provided within the lot to the satisfaction of the Director for the parking of bicycles belonging to the residents of the residential units in the building or buildings erected or to be erected on the lot and their bona fide guests, visitors or invitees at a rate of one space for every 4 residential units or part thereof or at such other rates as may be approved by the Director.
- (f) (i) Except the Parking Spaces for the Disabled Persons, each of the spaces provided under sub-clauses (a)(i) (as may be adjusted pursuant to Special Condition No.(50) hereof) and (b) of this Special Condition shall measure 2.5 metres in width and 5.0 metres in length with a minimum headroom of 2.4 metres.
- (ii) The dimensions of each of the Parking Spaces for the Disabled Persons shall be as the Building Authority may require and approve.
- (iii) Each of the spaces provided under sub-clause (d) of this Special Condition shall measure 1.0 metre in width and 2.5 metres in length with a minimum headroom of 2.4 metres or such other minimum headroom as may be approved by the Director.
- (iv) Each of the spaces provided under sub-clause (e) of this Special Condition shall be of such dimensions as may be approved in writing by the Director.
43. Special Condition No.(49) of the Land Grant stipulates that:
- (a) Spaces shall be provided within the lot to the satisfaction of the Director for the loading and unloading of goods vehicles at the following rates:
- (i) one space for every block of residential units erected or to be erected on the lot or at such other rates as may be approved by the Director subject to a minimum of one loading and unloading space for each block of residential units erected or to be erected on the lot, such loading and unloading space to be located adjacent to or within each block of residential unit; (For the purpose of this sub-clause, detached, semi-detached and terraced houses which are intended for use as single family residences shall not be regarded as a block of residential units);
- (ii) one space for every 2,000 square metres or part thereof of the gross floor area of the building or buildings erected or to be erected on the lot to be used for office purposes; and
- (iii) one space for every 800 square metres or part thereof of the gross floor area of the building or buildings erected or to be erected on the lot to be used for non-industrial (excluding residential, office, hotel, godown, and petrol filling station) purposes.
- (b) Each of the spaces provided under sub-clause (a) of this Special Condition shall measure 3.5 metres in width and 11.0 metres in length with a minimum headroom of 4.7 metres or of such other dimensions and headroom as may be approved by the Director. Such spaces shall not be used for any purpose other than for the loading and unloading of goods vehicles licensed under the Road Traffic Ordinance, any regulations made thereunder and any amending legislation in connection with the building or buildings erected on the lot.
- (c) For the purpose of calculating the number of spaces to be provided under sub-clauses (a)(i), (a)(ii) and (a)(iii) of this Special Condition, any floor area to be used for parking, loading and unloading purposes shall be excluded.
44. The Approval Letter further stipulates that under Special Condition No.(49)(b) of the Land Grant, each of the spaces provided under sub-clause (a) of Special Condition No.(49) of the Land Grant shall measure either 3.5 metres in width and 11.0 metres in length with a minimum headroom of 4.7 metres or 3.5 metres in width and 7.0 metres in length with a minimum headroom of 3.6 metres. The dimensions and headroom which each of the above spaces shall measure shall be approved by the Director.
- (iii) 根據本特別批地條款第(d)(i)(II)及(d)(i)(III)條提供的停車位除供停泊根據《道路交通條例》、其任何附屬規例及任何修訂法例持牌而屬於該地段上現已或將會興建的一幢或多幢建築物的佔用人及彼等真正賓客、訪客或獲邀請人士的電單車作本特別批地條款第(b)(i)(I)及(b)(i)(II)條所規定之各用途外，不可作任何其他用途，其中特別不可在車位上存放、陳列或展示車輛作招售等用途或提供洗車及汽車美容服務。
- (e) 該地段內須提供署長滿意的車位，以供停泊屬於現已或將會興建於該地段上一幢或多幢建築物中住宅單位的住客和彼等真正賓客、訪客或獲邀請人士的單車，配置比率為每4個住宅單位或不足此數配置1個車位或署長批准的其他比率。
- (f) (i) 除傷殘人士停車位外，根據本特別批地條款第(a)(i)條（可根據本文特別批地條款第(50)條調整）及(b)條提供的每個車位必須為2.5米闊及5.0米長，其最小淨高度為2.4米。
- (ii) 每個傷殘人士停車位的尺寸須依照建築事務監督之要求和批准。
- (iii) 每個根據本特別批地條款第(d)條提供的車位必須為1.0米闊及2.4米長，其最小淨高度為2.4米，或採用署長批准的其他最小淨高度。
- (iv) 每個根據本特別批地條款第(e)條提供的車位必須為署長書面批准的尺寸。
43. 批地文件特別批地條款第(49)條規定：
- (a) 該地段內須提供令署長全面滿意的車位，以供貨車裝卸貨物，按以下比率配置：
- (i) 每一現已或將會興建於該地段上的每一座住宅單位大廈配置1個車位或按照署長批准的其他比率配置，惟每座現有或將會興建於該地段上的住宅單位大廈最少須配置1個上落車位。該上落車位應設於每座住宅單位大廈內或毗鄰該處；（就此條款而言，擬用作一戶家庭的住所的獨立屋、半獨立屋或排屋不可視為一幢住宅單位大廈）；
- (ii) 該地段上現已或將會興建作為寫字樓用途的一幢或多幢建築物每2,000平方米的總樓面面積或不足此數提供1個車位；及
- (iii) 該地段上現已或將會興用作非工業用途（不包括私人住宅、寫字樓、貨倉、酒店及加油站）的一幢或多幢建築物每800平方米的總樓面面積或不足此數提供1個車位。
- (b) 每個根據本特別批地條款第(a)條提供的車位必須為3.5米闊及11.0米長，其最小淨高度為4.7米或採用署長批准的其他尺寸及淨空高度。該等車位除供根據《道路交通條例》、其任何附屬規例及任何修訂法例持牌的貨車就興建於該地段上的一幢或多幢建築物裝卸貨物外，不可作任何其他用途。
- (c) 就計算本特別批地條款第(a)(i)、(a)(ii)及(a)(iii)條提供的車位數目而言，任何作泊車及上落客貨之用的車位將被不會列入計算樓面面積。
44. 批准信再作規定按批地文件特別批地條款第(49)(b)條每個根據批地文件特別批地條款第(49)條第(a)條提供的車位必須為3.5米闊及11.0米長，其最小淨高度為4.7米或3.5米闊及7.0米長，其最小淨高度為3.6米。每個上述車位的尺寸及淨空高度須署長批准。

45. Special Condition No.(50) of the Land Grant stipulates that:
Notwithstanding sub-clause (a)(i) of Special Condition No.(48) hereof, the Grantee may increase or reduce the number of spaces required to be provided under the said sub-clause by not more than 5 percent provided that the total number of spaces so increased or reduced shall not exceed 50.
46. Special Condition No.(52) of the Land Grant stipulates that:
(a) Notwithstanding that these Conditions shall have been observed and complied with to the satisfaction of the Director, the Residential Parking Spaces and the Residential Motor Cycle Parking Spaces shall not be :
(i) assigned except
(I) together with undivided shares in the lot giving the right of exclusive use and possession of a residential unit or units in the building or buildings erected or to be erected on the lot or
(II) to a person who is already the owner of undivided shares in the lot with the right of exclusive use and possession of a residential unit or units in the building or buildings erected or to be erected on the lot; or
(ii) underlet except to residents of the residential units in the building or buildings erected or to be erected on the lot.
Provided that in any event not more than three in number of the total of the Residential Parking Spaces and the Residential Motor Cycle Parking Spaces shall be assigned to the owner or underlet to the resident of any one residential unit in the building or buildings erected or to be erected on the lot.
(b) Notwithstanding sub-clause (a) of this Special Condition, the Grantee may, with the prior written consent of the Director, assign all the Residential Parking Spaces and the Residential Motor Cycle Parking Spaces as a whole, but only to a wholly-owned subsidiary company of the Grantee.
(c) Sub-clause (a) of this Special Condition shall not apply to an assignment, underletting, mortgage or charge of the lot as a whole.
(d) Sub-clauses (a) and (b) of this Special Condition shall not apply to the Parking Spaces for the Disabled Persons.
47. Special Condition No.(53) of the Land Grant stipulates that:
The spaces provided within the lot in accordance with Special Condition Nos.(48)(a)(iii), (48)(c), (48)(e) and (49)(a) hereof shall be designated as and form part of the Common Areas.
48. Special Condition No.(57) of the Land Grant stipulates that:
(a) Where there is or has been any cutting away, removal or setting back of any land, or any building-up or filling-in or any slope treatment works of any kind whatsoever, whether with or without the prior written consent of the Director, either within the lot or on any Government land, which is or was done for the purpose of or in connection with the formation, levelling or development of the lot or any part thereof or any other works required to be done by the Grantee under these Conditions, or for any other purpose, the Grantee shall at his own expense carry out and construct such slope treatment works, retaining walls or other support, protection, drainage or ancillary or other works as shall or may then or at any time thereafter be necessary to protect and support such land within the lot and also any adjacent or adjoining Government or leased land and to obviate and prevent any falling away, landslip or subsidence occurring thereafter. The Grantee shall at all times during the term hereby agreed to be granted maintain at his own expense the said land, slope treatment works, retaining walls or other support, protection, drainage or ancillary or other works in good and substantial repair and condition to the satisfaction of the Director.
(b) Nothing in sub-clause (a) of this Special Condition shall prejudice the Government's rights under these Conditions, in particular Special Condition No.(56) hereof.
(c) In the event that as a result of or arising out of any formation, levelling, development or other works done by the Grantee or owing to any other reason, any falling away, landslip or subsidence occurs at any time, whether in or from any land within the lot or from any adjacent or adjoining Government or leased land, the Grantee shall at his own expense reinstate and make good the same to the satisfaction of the Director and shall indemnify the Government, its agents and contractors from and against all costs, charges, demands and claims whatsoever which shall or may be made, suffered or incurred through or by reason of such falling away, landslip or subsidence.
45. 批地文件特別批地條款第(50)條規定：
即使本文特別批地條款第(48)(a)(i)規定，承批人可增加或減少該條款所要求提供的車位數目，不多於車位數目之總額百分之5，惟其增加或減少之數目不得超過50個。
46. 批地文件特別批地條款第(52)條規定：
(a) 即使承批人已按署長滿意的方式遵守和履行此等條款，住宅停車位及住宅電單車停車位仍不得：
(i) 進行轉讓，除非：
(I) 連同賦予專有權使用及管有現已或將會興建於該地段上的一幢或多幢建築物當中一個或多個住宅單位之分割份數一併轉讓；或
(II) 承讓的人士現已擁有具專有權使用及管有現已或將會興建於該地段上的一幢或多幢建築物當中一個或多個住宅單位的分割份數；或
(ii) 分租，除非租予現已或將會興建於該地段上一幢或多幢建築物當中之住宅單位的住客，惟在任何情況下，不得轉讓或分租總數超過三個住宅停車位及住宅電單車停車位予現已或將會興建於該地段上一幢或多幢建築物內任何同一個住宅單位的業主或住客。
(b) 即使本特別批地條款第(a)條規定，承批人可以在取得署長事先書面同意下，將所有住宅停車位和住宅電單車停車位整體轉讓，但只可轉讓給承批人全資擁有的附屬公司。
(c) 本特別批地條款第(a)條的規定不適用於該地段的整體轉讓、分租、按揭或押記。
(d) 本特別批地條款第(a)及(b)條的規定不適用於傷殘人士停車位。
47. 批地文件特別批地條款第(53)條規定：
根據本文特別批地條款第(48)(a)(iii)、(48)(c)、(48)(e)及(49)(a)條於該地段內提供的車位須被指定為並構成公用地方的一部份。
48. 批地文件特別批地條款第(57)條規定：
(a) 倘為了或有關該地段或其任何部份之形成、平整或發展或根據此等條款承批人須完成之任何其他工程或因任何其他目的，於該地段內或任何政府土地上現時或以往曾經進行任何削走、移除或移後任何土地、或任何建造或填土或任何斜坡處理工程，不論以何種形式、亦不論有否獲得署長事先書面同意，承批人須自費進行及建造為保護及支承該地段內之土地及任何毗連或毗鄰政府土地或已租出土地及排除及防止其後發生之任何崩塌、山崩或下陷而當時或日後任何時間所須之斜坡處理工程，護土牆或其他支撐、保護、排水或附屬或其他工程。承批人須於批地年期內所有時間自費保養該土地、斜坡處理工程、護土牆或其他支撐、保護、排水或附屬或其他工程，以令其保持修葺良好堅固和狀況良好以令署長滿意。
(b) 本特別批地條款第(a)條的任何規定不得影響政府在此等條款下的權利，尤其是本文特別批地條款第(56)條。
(c) 倘因或由於承批人作出之形成、平整、發展或其他工程或因其他原因於任何時間不論在或由任何在該地段內土地或任何毗連或毗鄰政府土地或已租出土地導致或產生崩塌、山崩或下陷，承批人須自費使其回復原狀及將其修復令署長滿意，並須彌償政府、其代理及承建商因該崩塌、山崩或下陷而導致、蒙受或招致之所有任何性質的費用、收費、損害、訴求及索償。

(d) In addition to any other rights or remedies herein provided for breach of any of these Conditions, the Director shall be entitled by notice in writing to call upon the Grantee to carry out, construct and maintain the said land, slope treatment works, retaining walls, or other support, protection, and drainage or ancillary or other works or to reinstate and make good any falling away, landslip or subsidence, and if the Grantee shall neglect or fail to comply with the notice to the satisfaction of the Director within the period specified therein, the Director may forthwith execute and carry out any necessary works and the Grantee shall on demand repay to the Government the cost thereof, together with any administrative and professional fees and charges.

49. Special Condition No.(58) of the Land Grant stipulates that:

No rock crushing plant shall be permitted on the lot without the prior written approval of the Director.

50. Special Condition No.(59) of the Land Grant stipulates that:

Where prestressed ground anchors have been installed, upon development or redevelopment of the lot or any part thereof, the Grantee shall at his own expense carry out regular maintenance and regular monitoring of the prestressed ground anchors throughout their service life to the satisfaction of the Director and shall supply to the Director such reports and information on all such monitoring works as the Director may from time to time in his absolute discretion require. If the Grantee shall neglect or fail to carry out the required monitoring works, the Director may forthwith execute and carry out the monitoring works and the Grantee shall on demand repay to the Government the cost thereof.

51. Special Condition No.(60) of the Land Grant stipulates that:

(a) In the event of earth, spoil, debris, construction waste or building materials (hereinafter referred to as "the waste") from the lot, or from other areas affected by any development of the lot being eroded, washed down or dumped onto public lanes or roads or into or onto road-culverts, foreshore or seabed, sewers, storm-water drains or nullahs or other Government properties (hereinafter referred to as "the Government properties"), the Grantee shall at his own expense remove the waste from and make good any damage done to the Government properties. The Grantee shall indemnify the Government against all actions, claims and demands arising out of any damage or nuisance to private property caused by such erosion, washing down or dumping.

(b) Notwithstanding sub-clause (a) of this Special Condition the Director may (but is not obliged to), at the request of the Grantee remove the waste from and make good any damage done to the Government properties and the Grantee shall pay to the Government on demand the cost thereof.

52. Special Condition No.(61) of the Land Grant stipulates that:

The Grantee shall take or cause to be taken all proper and adequate care, skill and precautions at all times, and particularly when carrying out construction, maintenance, renewal or repair work (hereinafter referred to as "the Works"), to avoid causing any damage, disturbance or obstruction to any Government or other existing drain, waterway or watercourse, water main, road, footpath, street furniture, sewer, nullah, pipe, cable, wire, utility service or any other works or installations being or running upon, over, under or adjacent to the lot, the Green Area, the Green Stippled Black Area, or any combination of all or any part thereof (hereinafter collectively referred to as "the Services"). The Grantee shall prior to carrying out any of the Works make or cause to be made such proper search and enquiry as may be necessary to ascertain the present position and levels of the Services, and shall submit his proposals for dealing with any of the Services which may be affected by the Works in writing to the Director for his approval in all respects, and shall not carry out any work whatsoever until the Director shall have given his written approval to the Works and to such aforesaid proposals. The Grantee shall comply with and at his own expense meet any requirements which may be imposed by the Director in respect of the Services in granting the aforesaid approval, including the cost of any necessary diversion, relaying or reinstatement. The Grantee shall at his own expense in all respects repair, make good and reinstate to the satisfaction of the Director any damage, disturbance or obstruction caused to the lot, the Green Area, the Green Stippled Black Area, or any combination of all or any of the Services in any manner arising out of the Works (except for nullah, sewer, storm-water drain or water main, the making good of which shall be carried out by the Director, unless the Director elects otherwise, and the Grantee shall pay to the Government on demand the cost of such works). If the Grantee fails to carry out any such necessary diversion, relaying, repairing, making good and reinstatement of the lot, the Green Area, the Green Stippled Black Area, or any combination of all or any part thereof or of any of the Services to the satisfaction of the Director, the Director may carry out any such diversion, relaying, repairing, making good or reinstatement as he considers necessary and the Grantee shall pay to the Government on demand the cost of such works.

(d) 除了規定就任何違反此等條款的其他權利或補救之外，署長有權以書面通知要求承批人進行、建造及保養該等土地、斜坡處理工程、護土牆、或其他支承、保護、及排水或附屬或其他工程，或使其回復原狀及修復任何崩塌、山崩或下陷。倘承批人在該通知指定期限內忽視或未能遵守該通知以令署長滿意，署長可立即執行及進行任何必須之工程而承批人須應要求向政府付還有關費用連同任何行政或專業費用及收費。

49. 批地文件特別批地條款第(58)條規定：

未經署長事先書面批准，不得於該地段允許使用壓碎岩石機械。

50. 批地文件特別批地條款第(59)條規定：

如果在發展或重新發展該地段或其任何部份時已安裝預應力地樁，承批人須自費在預應力地樁的整個服務期限內定期保養與定期監察預應力地樁，以令署長滿意，並在署長不時絕對酌情要求時向署長提交所有該等監察工程的有關報告和資料。如果承批人忽視或未能進行要求的監察工程，署長可立即執行與進行該等監察工程，而承批人須應要求付還其開支給政府。

51. 批地文件特別批地條款第(60)條規定：

(a) 倘來自該地段或受該地段任何發展項目影響的其他地方的泥土、廢石方、瓦礫、建築廢料或建築材料（以下稱「廢材」）被侵蝕、沖刷或傾倒到公共小巷或道路或排入道路暗渠、前灘或海床、污水渠、雨水渠或明渠或其他政府物業（以下稱「政府物業」），承批人須自費清理該等廢材並且對政府物業所造成的任何損壞進行修復。承批人須就該等侵蝕、沖刷或傾倒而對私人物業造成的任何損壞或滋擾所產生的一切訴訟、索償及訴求向政府作出彌償。

(b) 即使本特別批地條款第(a)條規定，署長可以（但並無義務）應承批人的要求在政府物業清理廢材並對政府物業所造成的任何損壞進行修復，而承批人須應要求向政府支付有關的費用。

52. 批地文件特別批地條款第(61)條規定：

承批人須於任何時候，特別是在進行建造、保養、翻新或維修工程（下稱「工程」）時，採取或促使採取所有適當及充分的小心、技巧及預防措施，以避免對該地段、綠色範圍、綠色加黑點範圍或該等所有或其任何部份之上、上面、之下或毗連的任何政府或其他現存的排水渠、水路或水道、總水管、道路、行人路、街道設施、污水渠、明渠、喉管、電纜、電線、公用事業設施或任何其他工程或裝置（以下統稱「服務設施」）造成任何損害、騷擾或妨礙。承批人於進行任何工程之前須進行或促使進行有需要的完善調查及查詢核實服務設施的現時位置及水平，並向署長提交處理任何可能被工程影響的服務設施各方面的建議書供其批准，且必須取得署長對工程及上述該建議書作出的書面批准後，方可進行該等工程。承批人須遵從及自費履行署長在批准時對服務設施作出的任何要求，包括承擔進行任何必要的改道、重鋪或恢復原狀的費用。承批人須自費維修、修復及使其回復原狀任何因工程對該地段、綠色範圍、綠色加黑點範圍或該等所有或其任何部份或任何服務設施以任何方式引起的任何損害、騷擾或妨礙（除非署長另作選擇，否則明渠、污水渠、雨水渠或總水管須由署長進行修復，而承批人須應要求向政府支付該等工程的費用），以令署長全面滿意。如承批人未能對該地段、綠色範圍、綠色加黑點範圍或該等所有或其任何部份或任何服務設施進行任何該等必要的改道、重鋪、維修、修復及使其回復原狀工程，以令署長滿意，署長可進行其認為必要的任何該等改道、重鋪、維修、修復或使其回復原狀工程，而承批人須應要求向政府支付該等工程的費用。

53. Special Condition No.(62) of the Land Grant stipulates that:

- (a) The Grantee shall construct and maintain at his own expense and to the satisfaction of the Director such drains and channels, whether within the boundaries of the lot or on Government land, as the Director may consider necessary to intercept and convey into the nearest stream-course, catchpit, channel or Government storm-water drain all storm-water or rain-water falling or flowing on to the lot, and the Grantee shall be solely liable for and shall indemnify the Government and its officers from and against all actions, claims and demands arising out of any damage or nuisance caused by such storm-water or rain-water.
- (b) The works of connecting any drains and sewers from the lot to the Government storm-water drains and sewers, when laid and commissioned, may be carried out by the Director who shall not be liable to the Grantee for any loss or damage thereby occasioned and the Grantee shall pay to the Government on demand the cost of such connection works. Alternatively, the said connection works may be carried out by the Grantee at his own expense to the satisfaction of the Director and in such case any section of the said connection works which is constructed within Government land shall be maintained by the Grantee at his own cost and upon demand be handed over by the Grantee to the Government for future maintenance thereof at the expense of the Government and the Grantee shall pay to the Government on demand the cost of the technical audit in respect of the said connection works. The Director may, upon failure of the Grantee to maintain any section of the said connection works which is constructed within Government land, carry out such maintenance works as he considers necessary and the Grantee shall pay to the Government on demand the cost of such works.

54. Special Condition No.(65) of the Land Grant stipulates that:

No grave or columbarium shall be erected or made on the lot, nor shall any human remains or animal remains whether in earthenware jars, cinerary urns or otherwise be interred therein or deposited thereon.

53. 批地文件特別批地條款第(62)條規定：

- (a) 當署長認為必需時，承批人須自費在該地段範圍內或在政府土地建造及保養排水道和渠道，從而將降於或流入該地段的所有雨水及天雨水截流和引入最接近的河道、集水溝、水道或政府雨水渠以令署長滿意。承批人須獨自負責並彌償政府及其人員因該等雨水或天雨水導致任何損害或滋擾而引起的所有訴訟、索償和訴求。
- (b) 連接該地段的任何排水渠和污水渠至政府的雨水渠及污水渠（當已鋪設及啓用）的工程可由署長進行，但署長毋須就因此產生的任何損失或損害對承批人負責。承批人須應要求向政府支付上述連接工程的費用。該等連接工程亦可由承批人自費進行，以令署長滿意。在此情況下，上述連接工程的任何一段若在政府土地內建造，必須由承批人自費保養，且承批人須應要求移交給政府，由政府自費負責日後的保養。承批人須應要求向政府支付有關上述連接工程的技術審查的費用。如承批人未能保養在政府土地內建造的上述連接工程的任何一段，署長可進行其認為必要的保養工程，承批人須應要求向政府支付上述工程的費用。

54. 批地文件特別批地條款第(65)條規定：

不得於該地段興建或豎立墳墓或骨灰龕，亦不得於該地段安葬或存放任何人類骸骨或動物骸骨，無論是否存放在陶罐、骨灰甕或以其他之方式存放。

Notes:

1. The Plan No.ST3992-D1b annexed to the Land Grant and the Plan No.STM10402a annexed to the Approval Letter are reproduced under the "Information on Public Facilities and Public Open Spaces" section.
2. "Mini Transport Interchange Reserved Area" means the excluded strata of land and airspace in the areas referred to and defined in the First Schedule to the Land Grant.
3. The reference to "the Grantee" in the Land Grant in this section means Centralcon (Fo Tan) Company Limited and where the context in the Land Grant so admits or requires, includes successors and assigns.
4. For full details, please refer to the Land Grant. Full script of the Land Grant and the Approval Letter are available for free inspection upon request at the sales office during opening hours and copies of the Land Grant and Approval Letter can be obtained upon paying necessary photocopying charges.

備註：

1. 附於批地文件所夾附圖則號碼ST3992-D1b及批准信所夾附圖則號碼STM10402a於「公共設施及公眾休憩用地的資料」部份內複製。
2. 「小型交通運輸交匯處專用範圍」是指及應批地文件附表一所定義之被排除的地層及空域範圍。
3. 本部份提述的批地文件內的「承批人」乃指中洲（火炭）有限公司，若批地文件文意許可或要求，該詞包括承批人的繼承人及受讓人。
4. 詳情請參考批地文件及批准信。批地文件及批准信全份文本已備於售樓處，在開放時間可供免費查閱，並可在支付必要的影印費後獲取批地文件副本。

A. Any facilities that are required under the land grant to be constructed and provided for the Government, or for public

1. Description
 - (a) “the Green Area” as referred to in Special Condition No.(5)(a)(i)(I) of the Land Grant.
 - (b) “the Green Area Structures” as referred to in Special Condition No.(5)(a)(i)(II) of the Land Grant.
 - (c) “the Green Stippled Black Area” as referred to in Special Condition No.(5)(b)(i)(I) of the Land Grant.
 - (d) “the Green Stippled Black Area Structures” as referred to in Special Condition No.(5)(b)(i)(II) of the Land Grant.
 - (e) “the Pink Hatched Blue Area” as referred to in Special Condition No.(10)(a) of the Land Grant.
 - (f) “the Government Accommodation” as referred to in Special Condition No.(18)(a) of the Land Grant.
 - (g) “the Mini Transport Interchange Reserved Area” as referred to in Special Condition No.(31)(a) of the Land Grant.
 - (h) “the Pedestrian Walkway” as referred to in Special Condition No.(38)(d) of the Land Grant.
 - (i) Under Special Condition No.(39) of the Land Grant, the Grantee shall construct supports and connections within the lot between points R and S shown and marked on Plan I annexed to the Land Grant or such other points and at such levels as the Director may require.
2. The general public has the right to use the facilities mentioned in paragraphs 1(a), (b), (c), (d) and (h) in accordance with the Land Grant.

B (I). Any facilities that are required under the land grant to be managed, operated or maintained for public use at the expense of the owners of the residential properties in the Development

1. Description
 - (a) The Green Area and the Green Area Structures as referred to in Special Condition Nos.(5)(a)(i)(I) and (II) of the Land Grant (until such time as possession of the Green Area has been re-delivered to the Government in accordance with Special Condition No.(6) of the Land Grant).
 - (b) The Green Stippled Black Area and the Green Stippled Black Area Structures as referred to in Special Condition Nos.(5)(b)(i)(I) and (II) of the Land Grant (until such time as possession of the Green Stippled Black Area has been re-delivered to the Government in accordance with Special Condition No.(6) of the Land Grant).
 - (c) “the Items” as referred to in Special Condition No.(30)(a) of the Land Grant.
 - (d) The Pedestrian Walkway as referred to in Special Condition No.(38)(d) of the Land Grant.
2. The general public has the right to use the facilities mentioned in paragraphs 1(a), (b) and (d) in accordance with the Land Grant.
3. The facilities are required to be managed, operated or maintained at the expense of the owners of the residential properties in the Development.
4. The owners of the residential properties in the Development are required to meet a proportion of the expense of managing, operating or maintaining the facilities through the management expenses apportioned to the residential properties concerned.

(II). Any open space that is required under the land grant to be managed, operated or maintained for public use at the expense of the owners of the residential properties in the Development

Not applicable.

C. Size of any open space that is required under the land grant to be managed, operated or maintained for public use at the expense of the owners of the residential properties in the Development.

Not applicable.

D. Any part of the land (on which the Development is situated) that is dedicated to the public for the purposes of regulation 22(1) of the Building (Planning) Regulations (Cap. 123 sub. leg. F)

Not applicable.

A. 批地文件規定須興建並提供予政府或供公眾使用的任何設施

1. 描述
 - (a) 批地文件特別批地條款第(5)(a)(i)(I)條所指的「綠色範圍」。
 - (b) 批地文件特別批地條款第(5)(a)(i)(II)條所指的「綠色範圍構築物」。
 - (c) 批地文件特別批地條款第(5)(b)(i)(I)條所指的「綠色加黑點範圍」。
 - (d) 批地文件特別批地條款第(5)(b)(i)(II)條所指的「綠色加黑點範圍構築物」。
 - (e) 批地文件特別批地條款第(10)(a)條所指的「粉紅色加斜藍線範圍」。
 - (f) 批地文件特別批地條款第(18)(a)條所指的「政府樓宇」。
 - (g) 批地文件特別批地條款第(31)(a)條就「小型交通運輸交匯處專用範圍」例外保留的權利。
 - (h) 批地文件特別批地條款第(38)(d)條所指的「行人走道」。
 - (i) 批地文件特別批地條款第(39)條規定，承批人須提供及建造支承件及連接點以連接夾附圖則I所標示的R點和S點或其他由署長要求的地點及水平。
2. 公眾有權按照批地文件使用第1(a), (b), (c), (d) 及 (h) 段所述的設施。

B (I). 批地文件規定須由發展項目中的住宅物業的擁有人出資管理、營運或維持以供公眾使用的任何設施

1. 描述
 - (a) 批地文件特別批地條款第(5)(a)(i)(I)及(II)條所指的綠色範圍及綠色範圍構築物（直至綠色範圍的管有根據批地文件特別批地條款第(6)條交回政府）。
 - (b) 批地文件特別批地條款第(5)(b)(i)(I)及(II)條所指的綠色加黑點範圍及綠色加黑點範圍構築物（直至綠色加黑點範圍的管有根據批地文件特別批地條款第(6)條交回政府）。
 - (c) 批地文件特別批地條款第(30)(a)條所指的「該等物件」。
 - (d) 批地文件特別批地條款第(38)(d)條所指的「行人走道」。
2. 公眾有權按照批地文件使用第1(a), (b) 及 (d) 段所述的設施。
3. 該等設施按規定須由發展項目中的住宅物業的擁有人出資管理、營運或維持。
4. 發展項目中的住宅物業的擁有人按規定須以由有關住宅物業分攤的管理開支，應付管理、營運或維持該等設施的部分開支。

(II). 批地文件規定須由發展項目中的住宅物業的擁有人出資管理、營運或維持以供公眾使用的任何休憩用地

不適用。

C. 根據批地文件規定須由發展項目中的住宅物業的擁有人出資管理、營運或維持以供公眾使用的任何休憩用地的

不適用。

D. 發展項目所位於的土地中為施行《建築物（規劃）規例》（第123章，附屬法例F）第22(1)條而撥供公眾用途的任何部分

不適用。

E. Plan that shows the location of those facilities and open spaces and those parts of the land

Please refer to the plan at the end of this section.

F. Provisions of the land grant that concern those facilities and open spaces, and those parts of the land

(1) Special Condition No.(5) stipulates that:

- (a) The Grantee shall:
 - (i) within 84 calendar months from the date of this Agreement (or such other extended periods as may be approved by the Director), at his own expense, in such manner with such materials and to such standards, levels, alignment and design as the Director shall approve and in all respects to the satisfaction of the Director:
 - (I) lay and form those portions of future public roads shown coloured green on PLAN I (hereinafter referred to as "the Green Area"); and
 - (II) provide and construct such bridges, tunnels, over-passes, under-passes, culverts, viaducts, flyovers, pavements, roads or such other structures as the Director in his sole discretion may require (hereinafter collectively referred to as "the Green Area Structures") so that building, vehicular and pedestrian traffic may be carried on the Green Area;
 - (ii) within 84 calendar months from the date of this Agreement or such other extended periods as may be approved by the Director, at his own expense and to the satisfaction of the Director, surface, kerb and channel the Green Area and provide the same with such gullies, sewers, drains, fire hydrants with pipes connected to water mains, street lights, traffic signs, street furniture and road markings as the Director may require; and
 - (iii) maintain at his own expense the Green Area together with the Green Area Structures and all structures, surfaces, gullies, sewers, drains, fire hydrants, services, street lights, traffic signs, street furniture, road markings and plant constructed, installed and provided thereon or there in to the satisfaction of the Director until such time as possession of the Green Area has been delivered in accordance with Special Condition No.(6) hereof.
- (b) The Grantee shall:
 - (i) within 48 calendar months from the date of this Agreement (or such other extended periods as may be approved by the Director), at his own expense, in such manner with such materials and to such standards, levels, alignment and design as the Director shall approve and in all respects to the satisfaction of the Director:
 - (I) lay and form those portions of future public roads shown coloured green stippled black on PLAN I (hereinafter referred to as "the Green Stippled Black Area"); and
 - (II) provide and construct such bridges, tunnels, over-passes, under-passes, culverts, viaducts, flyovers, pavements, roads or such other structures as the Director in his sole discretion may require (hereinafter collectively referred to as "the Green Stippled Black Area Structures") so that building, vehicular and pedestrian traffic may be carried on the Green Stippled Black Area;
 - (ii) within 48 calendar months from the date of this Agreement or such other extended periods as may be approved by the Director, at his own expense and to the satisfaction of the Director, surface, kerb and channel the Green Stippled Black Area and provide the same with such gullies, sewers, drains, fire hydrants with pipes connected to water mains, street lights, traffic signs, street furniture and road markings as the Director may require; and
 - (iii) maintain at his own expense the Green Stippled Black Area together with the Green Stippled Black Area Structures and all structures, surfaces, gullies, sewers, drains, fire hydrants, services, street lights, traffic signs, street furniture, road markings and plant constructed, installed and provided thereon or therein to the satisfaction of the Director until such time as possession of the Green Stippled Black Area has been delivered in accordance with Special Condition No.(6) hereof.
- (c) In the event of the non-fulfilment of the Grantee's obligations under sub-clauses (a) or (b) of this Special Condition within the prescribed period stated therein, the Government may carry out the necessary works at the cost of the Grantee who shall pay to the Government on demand a sum equal to the cost thereof, such sum to be determined by the Director whose determination shall be final and binding upon the Grantee.

E. 顯示設施、休憩用地及土地中的該等部分的位置的圖則

請參閱本節結尾部分的圖則。

F. 批地文件中關於該等設施、休憩用地及土地中的該等部分的條文

(1) 批地文件特別批地條款第(5)條規定：

- (a) 承批人必須：
 - (i) 在本協議簽定日起84個曆月（或署長批准的其他延長日期）內，自費以署長批准的方式及物料，按署長批准的標準、水平、定線和設計，以令署長全面滿意：
 - (I) 鋪設及構造在批地文件所夾附圖則I內以綠色顯示的日後興建公共道路部份（以下稱「綠色範圍」）；及
 - (II) 提供及建造署長全權酌情決定要求的橋樑、隧道、上跨路、下通道、暗渠、高架道路、天橋、行人路、道路或其他構築物（以下統稱「綠色範圍構築物」）以致可在綠色範圍進行興建建築物及供車輛及行人往來；
 - (ii) 在本協議簽定日起84個曆月內或署長批准的其他延長日期，自費令署長滿意於綠色範圍表面整飾、興建路緣及渠道，以及按署長要求為此等設施提供溝渠、污水管、排水渠、消防栓及接駁主水管的水管、街燈、交通標誌、街道設施及道路標記；及
 - (iii) 自費保養綠色範圍連同綠色範圍構築物及在該處上及內建造、裝設及提供的所有結構物、路面、溝渠、污水管、排水渠、消防栓、服務設施、街燈、交通標誌、街道設施、道路標記及植物使署長滿意，直至根據本文特別批地條款第(6)條交還綠色範圍的管有權為止。
- (b) 承批人必須：
 - (i) 在本協議簽定日起48個曆月（或署長批准的其他延長日期）內，自費以署長批准的方式及物料，按署長批准的標準、水平、定線和設計，以令署長全面滿意：
 - (I) 鋪設及構造在批地文件所夾附圖則I內以綠色加黑點顯示的日後興建公共道路部份（以下稱「綠色加黑點範圍」）；及
 - (II) 提供及建造署長全權酌情決定要求的橋樑、隧道、上跨路、下通道、暗渠、高架道路、天橋、行人路、道路或其他構築物（以下統稱「綠色加黑點範圍構築物」）以致可在綠色加黑點範圍進行興建建築物及供車輛及行人往來；
 - (ii) 在本協議簽定日起48個曆月內或署長批准的其他延長日期，自費令署長滿意在綠色加黑點範圍表面整飾、興建路緣及渠道，以及按署長要求為此等設施提供溝渠、污水管、排水渠、消防栓及接駁主水管的水管、街燈、交通標誌、街道設施及道路標記；及
 - (iii) 自費保養綠色加黑點範圍連同綠色加黑點範圍構築物及在該處上及內建造、裝設及提供的所有結構物、路面、溝渠、污水管、排水渠、消防栓、服務設施、街燈、交通標誌、街道設施、道路標記及植物使署長滿意，直至根據本文特別批地條款第(6)條交還綠色加黑點範圍的管有權為止。
- (c) 倘若承批人未能於規定日期內履行其在本特別批地條款第(a)或(b)條的義務，政府可進行必要的工程，費用一概由承批人負責，承批人須應政府要求向其支付相等於該等費用的金額，該金額由署長決定，其決定為最終決定及對承批人具有約束力。

- (d) The Director shall have no liability in respect of any loss, damage, nuisance or disturbance whatsoever caused to or suffered by the Grantee or any other person whether arising out of or incidental to the fulfilment of the Grantee's obligations under sub-clauses (a) and (b) of this Special Condition or the exercise of the rights by the Government under sub-clause (c) of this Special Condition or otherwise, and no claim for compensation shall be made against the Government or the Director or his authorized officer by the Grantee in respect of any such loss, damage, nuisance or disturbance.
- (2) Special Condition No.(6) stipulates that:
For the purpose only of carrying out the necessary works specified in Special Condition No.(5) hereof, the Grantee shall on the date of this Agreement be granted possession of the Green Area and the Green Stippled Black Area. The Green Area and the Green Stippled Black Area shall be re-delivered to the Government on demand and in any event shall be deemed to have been re-delivered to the Government by the Grantee on the date of a letter from the Director indicating that these Conditions have been complied with to his satisfaction. The Grantee shall at all reasonable times while he is in possession of the Green Area and the Green Stippled Black Area allow free access over and along the Green Area and the Green Stippled Black Area for all Government and public vehicular and pedestrian traffic and shall ensure that such access shall not be interfered with or obstructed by the carrying out of the works whether under Special Condition No.(5) hereof or otherwise.
- (3) Special Condition No.(7) stipulates that:
The Grantee shall not without the prior written consent of the Director use the Green Area and the Green Stippled Black Area for the purpose of storage or for the erection of any temporary structure or for any purposes other than the carrying out of the works specified in Special Condition No.(5) hereof.
- (4) Special Condition No.(8) stipulates that:
(a) The Grantee shall at all reasonable times while he is in the possession of the Green Area and the Green Stippled Black Area:
(i) permit the Director, his officers, contractors and any other persons authorized by him, the right of ingress, egress and regress to, from and through the lot and the Green Area and the Green Stippled Black Area for the purpose of inspecting, checking and supervising any works to be carried out in compliance with Special Condition Nos.(5)(a) and (5)(b) hereof and the carrying out, inspecting, checking and supervising of the works under Special Condition No.(5)(c) hereof and any other works which the Director may consider necessary in the Green Area and the Green Stippled Black Area;
(ii) permit the Government and the relevant public utility companies authorized by the Government the right of ingress, egress and regress to, from and through the lot and the Green Area and the Green Stippled Black Area as the Government or the relevant public utility companies may require for the purpose of any works to be carried out in, upon or under the Green Area and the Green Stippled Black Area or any adjoining land including but not limited to the laying and subsequent maintenance of all pipes, wire, conduits, cable-ducts and other conducting media and ancillary equipment necessary for the provision of telephone, electricity, gas (if any) and other services intended to serve the lot or any adjoining or neighbouring land or premises. The Grantee shall co-operate fully with the Government and any of the aforesaid works to be carried out within the Green Area and the Green Stippled Black Area; and
(iii) permit the officers of the Water Authority and such other persons as may be authorized by them the right of ingress, egress and regress to, from and through the lot and the Green Area and the Green Stippled Black Area as the officers of the Water Authority or such authorized persons may require for the purpose of carrying out any works in relation to the operation, maintenance, repairing, replacement and alteration of any other waterworks installations within the Green Area and the Green Stippled Black Area.
(b) The Government shall have no liability in respect of any loss, damage, nuisance or disturbance whatsoever caused to or suffered by the Grantee or any other person arising out of or incidental to the exercise of the rights by the Government, its officers, agents, contractors, and any other persons or public utility companies duly authorized under sub-clause (a) of this Special Condition.
- (d) 倘因承批人履行本特別批地條款第(a)條及(b)條的義務或政府行使本特別批地條款第(c)條權力或其他情況，不論因處理或附帶之事宜而導致或令承批人或其他任何人士蒙受任何損失、損害、滋擾或騷擾，署長概不承擔任何責任，及承批人不得就任何該等損失、損害、滋擾或騷擾向政府或署長或獲其授權人員作出索償賠償。
- (2) 批地文件特別批地條款第(6)條規定：
茲為進行本文特別批地條款第(5)條規定的必要工程，承批人於本協議日獲綠色範圍及綠色加黑點範圍的管有權。承批人須在政府要求時將綠色範圍及綠色加黑點範圍交還予政府，及無論何時須在署長發出的信函說明所有該等批地條款已妥善履行並令其滿意當日將被視為已由承批人交還予政府。承批人在管有綠色範圍及綠色加黑點範圍期間，須於一切合理時間內允許所有政府及公眾車輛及行人自由通行及經越綠色範圍及綠色加黑點範圍，並確保該通行不會因為進行工程及不論是否根據本文特別批地條款第(5)條進行的工程而受到干擾或妨礙。
- (3) 批地文件特別批地條款第(7)條規定：
未經署長事先書面同意，承批人不得將綠色範圍及綠色加黑點範圍用作儲物或興建任何臨時結構物或用作進行本文特別批地條款第(5)條規定的工程以外的任何其他用途。
- (4) 批地文件特別批地條款第(8)條規定：
(a) 承批人須於管有綠色範圍及綠色加黑點範圍的所有合理時間內：
(i) 批准署長及其人員、承建商及獲署長授權的其他任何人士有權通行、進出、往返及行經該地段及綠色範圍，以便視察、檢查及監督遵照本文特別批地條款第(5)(a)及(5)(b)條規定進行的任何工程，以及進行、視察、檢查及監督本文特別批地條款第(5)(c)條規定的工程及署長認為於綠色範圍及綠色加黑點範圍內必要的任何其他工程；
(ii) 在政府或獲其授權的相關公用設施公司要求時，批准政府或獲其授權的相關公用設施公司有權通行、進出、往返及行經該地段、綠色範圍及綠色加黑點範圍，以便在綠色範圍及綠色加黑點範圍或任何毗鄰土地之內、之上或之下進行任何工程，包括但不限於鋪設及其後保養所有喉管、電線、管道、電纜槽及擬為該地段或任何毗鄰或相鄰土地或場所提供電話、電力、煤氣（如有）及其他服務設施所需的其他傳導媒介及附帶設備。承授人須就以上在綠色範圍及綠色加黑點範圍內進行的任何工程所有相關事宜，與政府及獲其正式授權的相關公用設施公司充分合作；及
(iii) 在水務監督的人員及彼等授權的其他人士要求時，批准水務監督的人員及彼等授權的其他人士有權通行、進出、往返及行經該地段、綠色範圍及綠色加黑點範圍，以便在綠色範圍及綠色加黑點範圍內進行任何有關任何其他水務設施的運作、保養、維修、更換及改動工程。
(b) 倘因政府、其人員、代理、承建商及根據本特別批地條款第(a)條獲授權的其他任何人士或公用設施公司行使權力，不論因處理或附帶之事宜而導致或令承批人或其他任何人士蒙受任何損失、損害、滋擾或騷擾，政府概不承擔任何責任。

- (5) Special Condition No.(10) stipulates that:
- (a) The Grantee shall lay and form the primary school site area shown coloured pink hatched blue on PLAN I (hereinafter referred to as "the Pink Hatched Blue Area") on or before the 30th day of September, 2021 or within such other extended period or periods as may be approved by the Director at his own expense, in such manner, with such materials and to such standards, levels, alignment and design as the Director shall approve and in all respects to the satisfaction of the Director.
 - (b) In the event of the non-fulfilment of the Grantee's obligations under sub-clause (a) of this Special Condition within the prescribed period stated therein, the Government may carry out the necessary works at the cost of the Grantee who shall pay to the Government on demand a sum equal to the cost thereof, such sum to be determined by the Director whose determination shall be final and binding upon the Grantee.
 - (c) The Government, the Director, his officers, contractors, his or their workmen and any other persons duly authorized by him shall have no liability in respect of any loss, damage, nuisance or disturbance whatsoever caused to or suffered by the Grantee or any other person whether arising out of or incidental to the fulfilment of the Grantee's obligations under sub-clause (a) of this Special Condition or the exercise of the rights by the Government, the Director, his officers, contractors, his or their workmen and any other persons duly authorized by him under sub-clause (b) of this Special Condition or otherwise, and no claim for compensation or otherwise shall be made against the Government or the Director or his officers, contractors, his or their workmen and any other persons duly authorized by him in respect of any such loss, damage, nuisance or disturbance.
- (6) Special Condition No.(11) stipulates that:
The Grantee shall at all reasonable times prior to the surrender of the whole of the Pink Hatched Blue Area to the Government in accordance with Special Condition No.(12)(a) hereof permit the Director, his officers, contractors, his or their workmen and any other persons authorized by him, with or without tools, equipment, machinery or motor vehicles, the right of free and unrestricted ingress, egress and regress to, from and through the lot and the Pink Hatched Blue Area for the purpose of inspecting, checking and supervising any works to be carried out in compliance with Special Condition No.(10) (a) hereof and the carrying out, inspecting, checking and supervising of the works under Special Condition No.(10)(b) hereof and any other works which the Director may consider necessary in the Pink Hatched Blue Area.
- (7) Special Condition No.(12) stipulates that:
- (a) The Grantee shall at his own expense at any time or times when called upon to do so by the Director surrender to the Government and deliver up vacant possession of the Pink Hatched Blue Area or any part or parts thereof free from all incumbrances and without any consideration, payment or compensation whatsoever payable by the Government to the Grantee. For the purpose of this sub-clause, the Grantee shall at his own expense execute a deed or deeds of surrender and any other necessary documents in such form and containing such provisions as the Director shall approve or require.
 - (b) The Grantee shall not assign, mortgage, charge, demise, underlet, part with the possession of or otherwise dispose of or encumber the lot or any part or parts thereof or any interest therein or any building or buildings or part or parts of any building or buildings thereon or enter into any sub-clause (a) of this Special Condition unless and until the Grantee has at his own expense carved out the Pink Hatched Blue Area from the lot to the satisfaction of the Director, provided that this sub-clause (b) shall not apply to an assignment of the lot as a whole as provided under Special Condition No.(55) hereof or a building mortgage as provided in Special Condition No.(43) (d) hereof. Prior to the said carving out, the Grantee shall at his own expense submit the carving out document to the Director for his written approval.
- (5) 批地文件特別批地條款第(10)條規定：
- (a) 承批人須在2021年9月30日或之前或署長批准的其他延長日期內，自費以署長批准的方式及物料，按署長批准的標準、水平、定線和設計並全面令署長滿意，鋪設及構造批地文件所夾附圖則I以粉紅色加斜藍線顯示的小學場地範圍（以下稱「粉紅色加斜藍線範圍」）。
 - (b) 倘若承批人未能於所載日期內履行其在本特別批地條款第(a)條的義務，政府可進行必要的工程，費用一概由承批人負責，承批人並須應要求向政府支付相等於該等費用的金額，該金額由署長決定，其決定為最終決定及對承批人具有約束力。
 - (c) 倘因承批人履行本特別批地條款第(a)條的義務或政府、署長、其人員、承建商、其或該等工人和根據本特別批地條款第(b)條或其他情況獲授權的其他任何人士行使權力，不論因處理或附帶之事宜而導致或令承批人或其他任何人士蒙受任何損失、損害、滋擾或騷擾，政府、署長、其人員、承建商、其或該等工人及獲授權的其他任人士概不承擔任何責任，及承批人不得就任何該等損失、損害、滋擾或騷擾向政府、署長、其人員、承建商、其或該等工人及獲授權的其他任人士作出索償賠償。
- (6) 批地文件特別批地條款第(11)條規定：
承批人須於按照本文特別批地條款第(12)(a)條完全歸還粉紅色加斜藍線範圍予政府前之任何時間內批准署長、其人員、承建商、其及該等工人及任何其他獲授權人士，不論有否帶同工具、設備、器械或車輛，有權自由及不受限制通行、進出、往返及行經該地段及粉紅色加斜藍線範圍，以便視察、檢查和監督根據本文特別批地條款第(10)(a)條進行的任何工程及進行、視察、檢查和監督根據本文特別批地條款第(10)(b)條的工程，以及任何於粉紅色加斜藍線範圍內，署長認為必要的其他任何工程。
- (7) 批地文件特別批地條款第(12)條規定：
- (a) 承批人須自費並免卻任何產權負擔及無須政府向承批人支付任何性質的代價、償付或賠償的情況下，於任何時間應署長作出要求履行之時向政府歸還及移交粉紅色加斜藍線範圍或其任何一部份或多部份的空置管有權。就本特別批地條款而言，承批人須自費簽訂一份或多份土地歸還契約及任何採取署長批准或要求的格式並載明指定條款且必須之其他文件。
 - (b) 承批人不得於根據本特別批地條款第(a)條向政府歸還粉紅色加斜藍線範圍前轉讓、按揭、押記、批租、分租、放棄管有權或處置或妨礙該地段或其任何一部份或多部份或任何權益或其上任何一幢或多幢建築物或其任何一部份或多部份或簽署任何轉讓協議，除非直到承批人已自費從該地段分割出粉紅色加斜藍線範圍，並令署長滿意，本特別批地條款第(b)條並不適用於本文特別批地條款第(55)條所訂明的關於該地段整體轉讓的轉讓契約或根據本文特別批地條款第(43)(d)條所訂明的建築按揭。承批人須於該分割前，自費向署長遞交供其書面批核的分割文件。

(8) Special Condition No.(18) stipulates that:

- (a) The Grantee shall at his own expense and in all respects to the satisfaction of the Director erect, construct and provide within the lot, in a good workmanlike manner and in accordance with the Technical Schedule annexed hereto (hereinafter referred to as "the Technical Schedule") and the plans approved under Special Condition No.(19)(a) hereof one public transport terminus on months from the date of this Agreement (which accommodation (including lighting fixtures, ventilation plant, extract ductworks and road/floor surfaces but excluding such lifts, escalators, stairways, plant, equipment and other facilities not serving exclusively thereto as may be permitted by the Director in accordance with these Conditions, walls, columns, beams, ceilings, roof slabs, carriageway/floor slabs and any other structural elements) together with any other areas, facilities, services and installations exclusive thereto as the Director may in his absolute discretion determine (whose determination shall be conclusive and binding on the Grantee) are hereinafter collectively referred to as "the Government Accommodation"). Upon obtaining the prior written consent of the Director and subject to such conditions as the Director may impose from time to time, including the payment of additional premium and administrative fee all to be assessed by the Director at his discretion, the Grantee may at his cost and expense, at all times before the assignment referred to in Special Condition No.(24) hereof and the delivery of the vacant possession of the Government Accommodation or any part thereof referred to in Special Condition No.(26) hereof, use and occupy the Government Accommodation or any part or parts thereof for such purposes as the Director may approve and in all respects to the satisfaction of the Director, provided always that the Grantee shall indemnify, and keep indemnified the Government against all claims, costs, demands, charges, damages, actions and proceedings of whatsoever nature arising out of or in connection with the use and occupation of the Government Accommodation or any part or parts thereof.
- (b) The Government hereby reserves:
- (i) the right to alter or vary in its absolute discretion at any time the use of the Government Accommodation or any part thereof; and
- (ii) the right to permit such persons as the Government may from time to time approve to use the Government Accommodation.
- (c) (i) For the purpose of determining the net operational floor area of any part of the Government Accommodation, the net operational floor area shall, unless otherwise stated, be taken as comprising the total of the net floor areas of all rooms and spaces within such part of the Government Accommodation as detailed in the Technical Schedule excluding any structures and partitions, circulation areas, staircases, staircase halls, lift landings, space occupied by toilet facilities, mechanical and electrical services such as lifts and air-conditioning systems.
- (ii) For the purpose of this Special Condition, the net floor area of a room or space shall be that area enclosed within the perimeter walls or boundaries of a room or space as measured between the finished or notional wall surfaces, free-standing columns or wall columns within that room or space.

(9) Special Condition No.(19) stipulates that:

- (a) (i) The Grantee shall submit or cause to be submitted to the Director for his written approval plans of the Government Accommodation which shall include details as to the level, position and design of the Government Accommodation and any other details as the Director may require.
- (ii) Upon approval being given to the plans of the Government Accommodation, no amendment, variation, alteration, modification or substitution thereto shall be made by the Grantee except with the prior written approval of the Director or except as required by the Director.
- (iii) The plans of the Government Accommodation approved under this sub-clause (a) shall be deemed to incorporate any amendment, variation, alteration, modification or substitution subsequently approved or required by the Director.
- (b) No building works other than site formation works shall be commenced on the lot until the plans of the Government Accommodation shall have been approved by the Director under sub-clause (a) of this Special Condition.

(8) 批地文件特別批地條款第(18)條規定：

- (a) 承批人須自費以達至署長全面滿意的程度並以良好工藝方式，按照批地文件所夾附工程規格附表（以下稱「工程規格附表」）及根據本文特別批地條款第(19)(a)條已批核的圖則，在該地段內地面樓層上興建、建造和提供一個公共運輸交匯處，並於本協議簽定日起84個曆月時或前完成及達至適宜佔用及運作的程度（其處所（包括照明裝置、通風系統、抽風管道及道路/地平面但不包括電梯、自動扶手電梯、樓梯、機器、設備及並不專屬於該處所而署長可根據此等條款批准的其他設施、牆壁、樁柱、基腳、天花板、屋頂面板、車行通道/地面平板及任何其他支承件）連同任何範圍、設施、服務及裝置均專屬該處而署長全權酌情決定（其決定為最終的決定及對承批人具有約束力）以下統稱「政府樓宇」）。在取得署長事前書面同意及遵照署長不時訂明的該等條款，包括額外地價及行政費用全由署長酌情決定，承批人可於自行承擔其費用的前提下，於根據本文特別批地條款第(24)條轉讓及交付根據本文特別批地條款第(26)條訂明的政府樓宇或其任何部份的空置管有權前的所有時間，使用和佔用政府樓宇或其任何部份，以用作署長批准及令署長全面滿意之該等用途，惟承批人須就使用或佔用政府樓宇或其任何一部份或多部份導致或產生的所有及任何性質的索償、費用、訴求、收費、損害、訴訟及其他法律程序向政府彌償，並確保其免責。
- (b) 政府現保留：
- (i) 其絕對酌情權利以在任何時候不時改動或更改政府樓宇或其任何部份的用途；及
- (ii) 其權利以批准不時獲政府授權之人士使用政府樓宇。
- (c) (i) 就釐定政府樓宇任何部份的淨作業樓面面積而言，除非另有說明，否則淨作業樓面面積將視為包含工程規格附表詳列政府樓宇部份內所有房間及空間的淨樓面總面積，但不包括任何結構物及間隔、流通地方範圍、樓梯、樓梯大堂、電梯平台、廁所設備所佔用空間及電梯與空調系統等機電服務。
- (ii) 就本特別批地條款而言，個別房間或空間的淨樓面面積指該房間或空間圍牆或邊界圍牆內由該處已整飾或概念性牆壁表面、獨立柱或牆柱之間量度所得的面積。

(9) 批地文件特別批地條款第(19)條規定：

- (a) (i) 承批人須向署長提交或促使提交政府樓宇的圖則以供其書面批核。該政府樓宇圖則須包括政府樓宇的水平、位置及設計詳情，以及署長要求的任何其他詳細資料。
- (ii) 政府樓宇圖則獲批准後，除非事前獲署長書面批准或署長規定，否則承批人不得將其修改、更改、改動、修訂或替代。
- (iii) 根據本特別批地條款第(a)條批核的政府樓宇圖則須被視作包含署長已批准或規定的修改、更改、改動、修訂或替代。
- (b) 署長根據本特別批地條款第(a)條規定批核政府樓宇圖則前，該地段上不可進行地盤平整工程以外的任何建築工程。

(10) Special Condition No.(20) stipulates that:

- (a) The Director shall have the right to amend, vary, alter, modify or substitute the Technical Schedule as he shall in his absolute discretion deem fit.
- (b) No amendment, variation, alteration, modification or substitution to the Technical Schedule shall be made by the Grantee except with the prior written approval of the Director.
- (c) Any amendment, variation, alteration, modification or substitution by the Director under sub-clause (a) of this Special Condition or by the Grantee as approved by the Director under sub-clause (b) of this Special Condition shall be deemed to be incorporated into the Technical Schedule and form part thereof.

(11) Special Condition No.(22) stipulates that:

- (a) The Director shall have the right in his absolute discretion to nominate officers of Government departments (hereinafter referred to as “the Officers”) who shall generally oversee the design, construction, provision and completion of the Government Accommodation and shall monitor the construction, provision and completion (hereinafter collectively referred to as “the Construction Works”) of the Government Accommodation in order to ensure that the Construction Works of the Government Accommodation are carried out in accordance with these Conditions.
- (b) The Grantee shall notify the Officers of any condition, restriction, requirement and information affecting or relating to the Government Accommodation or any part thereof or the Construction Works of the Government Accommodation or any part thereof forthwith upon the same becoming known to the Grantee, his servants, agents, contractors and workmen and shall make available all drawings, site records, notices, letters, certificates, approvals and information and render all necessary assistance and co-operation to the Officers when required by the Officers.
- (c) The Grantee shall keep the Director and the Officers advised from time to time as to when he shall be in a position to apply for the relevant Occupation Permit or Temporary Occupation Permit from the Building Authority in respect of the Government Accommodation or any part thereof.
- (d) The Government and the Director accept no responsibility or liability for any costs, claims, demands, charges, damages, actions or proceedings of whatsoever nature arising out of or in connection with the exercise by the Officers of the authority conferred under sub-clause (a) of this Special Condition.
- (e) The Grantee shall indemnify the Government and the Director from and against all liabilities, costs, expenses, claims, actions, demands and proceedings of whatsoever nature arising out of or in connection with the Construction Works of the Government Accommodation or any part thereof.

(12) Special Condition No.(23) stipulates that:

- (a) Within 14 days after completion of the Government Accommodation or such part thereof, the Grantee shall deliver to the Director a certificate by an authorized person (as defined in the Buildings Ordinance, any regulations made thereunder and any amending legislation) employed by the Grantee for the development of the lot that the Government Accommodation or such part thereof has been completed in accordance with these Conditions.
- (b) Where in the opinion of the Director (whose decision in this respect shall be final and binding upon the Grantee) the Government Accommodation has been completed and made fit for occupation and operation to his satisfaction, the Director shall issue to the Grantee a certificate of completion to that effect provided that the Director may in his absolute discretion issue a certificate of completion in respect of a part of the Government Accommodation which the Director considers to have been completed and made fit for occupation and operation to his satisfaction.
- (c) Notwithstanding the issue of any certificate of completion by the Director, the Grantee shall not be absolved from any of his liabilities under Special Condition Nos.(22)(e) and (28) hereof nor any other obligations remaining to be observed and performed by him under these Conditions.

(10) 批地文件特別批地條款第(20)條規定：

- (a) 署長有權按其全權酌情視為恰當，修改、更改、改動、修訂或替代工程規格附表。
- (b) 除非事前獲得署長書面批准，承批人不可修改、更改、改動、修訂或替代工程規格附表。
- (c) 署長根據本特別批地條款第(a)條進行或承批人按照本特別批地條款第(b)條規定經署長批准進行的工程規格附表修改、更改、改動、修訂或替代項目，須被視作已納入工程規格附表並構成其一部分。

(11) 批地文件特別批地條款第(22)條規定：

- (a) 署長可全權酌情指定政府部門人員（以下稱「政府人員」）概括監管政府樓宇的設計、建造、裝配及完工，同時監察其建造裝配及完工情況（以下稱「建造工程」），以確保政府樓宇的建造工程按照此等條款進行實施。
- (b) 承批人就其知悉或其僱員、代理、承建商及工人知悉任何影響或關乎政府樓宇或其任何部份或政府樓宇或其部份建造工程的狀況、限制、規定及資料，必須即時通知政府人員，並須提供所有圖則、工地記錄、通知書、函件、證書、批准書及資料，並且在政府人員要求時提供所有必要支援和充分合作予政府人員。
- (c) 承批人須不時建議署長及政府人員其何時可向建築事務監督申領政府樓宇或其任何部份的相關佔用許可證或臨時佔用許可證。
- (d) 倘因政府人員行使本特別批地條款第(a)條的權力，不論因處理或附帶之事宜而導致任何費用、索償、訴求、收費、損害、訴訟及法律程序，政府及署長概不承擔任何責任或義務。
- (e) 承批人須就政府樓宇或其任何部份建造工程導致或產生的所有及任何性質的責任、費用、開支、索償、訴訟、訴求及法律程序向政府及署長彌償並確保其免責。

(12) 批地文件特別批地條款第(23)條規定：

- (a) 政府樓宇或有關部份落成後14日內，承批人須向署長提交由承批人就發展該地段所聘用之認可人士（釋義以《建築物條例》、其任何附屬規例及任何修訂法例所訂為準）簽發的證明書，證明已依照此等條款建成政府樓宇或該有關部份。
- (b) 如署長認為（其意見為最終的決定並對承批人有約束力）政府樓宇已以達其滿意建成並適合佔用及運作，便會就此向承批人發出完工證明書。然而，署長可全權酌情就其認為已達其滿意建成並適宜佔用和運作的政府樓宇部份簽發完工證明書。
- (c) 即使署長簽發完工證明書，本文特別批地條款第(22)(e)及(28)條訂明承批人須有的責任和此等條款指定其仍須履行及遵守的其他責任亦不會因此而被免除。

(13) Special Condition No.(24) stipulates that:

- (a) Notwithstanding anything to the contrary herein contained, the Grantee shall when called upon so to do by the Director assign to The Financial Secretary Incorporated a corporation sole in incorporated under and by virtue of the Financial Secretary Incorporation Ordinance, any regulations made thereunder and any amending legislation (hereinafter referred to as "F.S.I." which expression shall if the context permits include its successors and assigns), with vacant possession, free from incumbrances, at the expense of the Grantee, the undivided shares specified in sub-clause (b) of this Special Condition together with the right to the exclusive use, occupation and enjoyment of the Government Accommodation and the Grantee shall complete the assignment of the Government Accommodation or any part thereof in respect of which a certificate of completion shall have been issued under Special Condition No.(23) hereof within such time or times as may be specified in writing by the Director. For the avoidance of doubt, the Grantee acknowledges that the Government shall be under no obligation to accept the assignment of the Government Accommodation or any part thereof at the request of the Grantee, but may do so as and when the Government sees fit.
- (b) The number of undivided shares in the whole of the lot to be assigned to F.S.I. in accordance with sub-clause (a) of this Special Condition shall be determined by the Director having regard to the proportion which the gross floor area of the Government Accommodation shall bear to the gross floor area of all the buildings erected or to be erected within the lot. The determination of the Director in this respect shall be final and binding upon the Grantee.
- (c) When called upon to do so by the Director (irrespective of whether the Grantee shall have been called upon to assign under sub-clause (a) of this Special Condition) the Grantee shall submit or cause to be submitted to the Director for his approval in writing an Assignment in respect of the Government Accommodation which Assignment shall be in such form and shall contain such provisions as shall be required or approved by the Director.
- (d) On completion of the assignment of the Government Accommodation or any part thereof the Grantee shall deliver to F.S.I. at the expense of the Grantee one set of the original or certified copies of deeds and documents of title relating to the lot and the Memorial of the Assignment in respect of the Government Accommodation or such part thereof duly completed and verified by the certificate of the solicitor for the Grantee. All fees payable on registration of the Assignment in the Land Registry shall be borne by the Grantee solely.

(14) Special Condition No.(26) stipulates that:

The Director shall have the right to demand at any time before the assignment of the Government Accommodation pursuant to Special Condition No.(24) hereof, delivery of vacant possession of the Government Accommodation or such part thereof as required by the Director in respect of which a certificate of completion shall have been issued under Special Condition No.(23) hereof and the Grantee shall upon such demand deliver the same to the Government for its exclusive use, occupation and operation upon such terms and conditions as the Director may consider appropriate.

(15) Special Condition No.(27) stipulates that:

- (a) Without prejudice to the provisions of Special Condition No.(28) hereof the Grantee shall, at all times before the assignment referred to in Special Condition No.(24) hereof and the delivery of the vacant possession of the Government Accommodation or any part thereof referred to in Special Condition No.(26) hereof and until expiry of the Defects Liability Period referred to in Special Condition No.(28)(a) hereof, at his own expense manage and maintain in good condition and in all respects to the satisfaction of the Director the Government Accommodation and the building services installations therefor.
- (b) For the purpose of this Special Condition only, the expression "Grantee" shall include the assignees whose title is derived from the Grantee under Special Condition No.(55) hereof, but otherwise exclude his assigns.

(13) 批地文件特別批地條款第(24)條規定：

- (a) 即使本文另有相反規定，承批人須在署長作出要求時，自費及不帶任何產權負擔的形式，向根據《財政司司長法團條例》、其任何附屬規例及任何修訂法例成立為單一法團之「財政司司長法團」（以下稱「財政司司長法團」並如上下文意允許包括其繼承人及受讓人）轉讓本特別批地條款第(b)條所訂的不分割份數及空置管有權，以及使用、佔用和享用政府樓宇的專有權利，承批人須於署長書面指定的任何時間內完成轉讓已根據本文特別批地條款第(23)條獲發完工證明書的政府樓宇或其任何部份。為免存疑，承批人確認政府並無責任按承批人要求接受政府樓宇或其任何部份的轉讓，惟政府可於其認為適合時間下而進行。
- (b) 按本特別批地條款第(a)條轉讓予財政司司長法團的該地段整體內不分割份數數額將由署長根據政府樓宇總樓面面積佔現已或將會興建於該地段內所有建築物總樓面面積的比例釐定。署長的有關決定為最終的決定並對承批人有約束力。
- (c) 在署長作出要求時（不論承批人是否根據本特別批地條款第(a)條所訂被要求轉讓），承批人須向署長提交或促使提交有關政府樓宇的轉讓契約，以供署長書面批核。轉讓契約應採取署長指定或批准的格式並載明指定條款。
- (d) 政府樓宇或其任何部份的轉讓交易完成時，承批人須自費向財政司司長法團提交一套該地段契約及文件的正本或核證文本，以及由承批人律師填妥並以證明書核實的政府樓宇或其該部份的轉讓契約之註冊摘要。於土地註冊處註冊轉讓契約的所有應繳費用一律由承批人獨自承擔。

(14) 批地文件特別批地條款第(26)條規定：

署長有權在根據本文特別批地條款第(24)條轉讓政府樓宇之前的任何時間要求交付已根據本文特別批地條款第(23)條發出完工證明書的政府樓宇或其署長規定之部份之空置管有權。承批人須於接獲要求時，將其交予政府，以供政府按照署長視為恰當的條款與條件專有使用、佔用及運作。

(15) 批地文件特別批地條款第(27)條規定：

- (a) 茲毋損本文特別批地條款第(28)條之規定，承批人須在根據本文特別批地條款第(24)條轉讓政府樓宇之前及根據本文特別批地條款第(26)條交付政府樓宇或其任何部份之空置管有權前的所有時間，及直至本文特別批地條款第(28)(a)條訂明的保養期屆滿自費管理及保養政府樓宇和該處各建築物服務設置以保持其狀態良好達至署長全面滿意。
- (b) 就本特別批地條款而言，「承批人」一詞包括本文特別批地條款第(55)條所載的承讓人但不包括其受讓人。

(16) Special Condition No.(28) stipulates that:

- (a) The Grantee shall indemnify and keep indemnified the Government and F.S.I. against all claims, costs, demands, charges, damages, actions and proceedings of whatsoever nature arising out of or in connection with any defects, wants of repair, imperfections, breakdown, faults or any other outstanding works (whether in respect of workmanship, material, design or otherwise) in the Government Accommodation and in the building services installations therefor-
 - (i) which may exist at the date of delivery of vacant possession by the Grantee of the Government Accommodation or any part thereof; and
 - (ii) which shall occur or become apparent within a period of 365 days after the date of delivery of vacant possession by the Grantee of the Government Accommodation or any part thereof (hereinafter referred to as "Defects Liability Period").
- (b) Whenever required by the Director or F.S.I. or both, the Grantee shall at his own expense and within such time and to such standard and in such manner as may be specified by the Director or F.S.I. or both carry out all works of maintenance, repair, amendment, reconstruction and rectification and any other works as may be necessary to remedy and rectify any defects, wants of repair, imperfections, breakdown, faults or any other outstanding works in the Government Accommodation or any part thereof and the building services installations therefor which shall occur or become apparent within any Defects Liability Period. In addition to the foregoing, the Grantee shall at his own expense and within such time and to such standard and in such manner as may be specified by the Director or F.S.I. or both make good and rectify any defects, wants of repair, imperfections, breakdown, faults or any other outstanding works in the Government Accommodation or any part thereof and the building services installations therefor which may exist at the date of delivery of possession thereof by the Grantee.
- (c) The Director or F.S.I. or both will, shortly before the expiry of the Defects Liability Period, cause an inspection to be carried out in respect of the relevant part of the Government Accommodation and the building services installations therefor for the purpose of identifying any defects, wants of repair, imperfections, breakdown, faults or any other outstanding works which may be evident. The Director and F.S.I. reserve the right to each of them to serve upon the Grantee within 14 days after the expiry of the Defects Liability Period a Schedule or Schedules of Defects specifying any defects, wants of repair, imperfections, breakdown, faults or any other outstanding works which may be evident in the relevant part of the Government Accommodation and the building services installations therefor and the Grantee shall at his own expense cause all necessary works to be carried out so as to remedy and rectify the same within such time and to such standard and in such manner as may be specified by the Director or F.S.I. or both.
- (d) If the Grantee shall fail to carry out any of the works referred to in sub-clauses (b) and (c) of this Special Condition, then any such works may be carried out by the Government or F.S.I. or both and all costs and charges incurred in connection therewith by the Government or F.S.I. or both as certified by the Director (whose decision shall be final and binding upon the Grantee) together with a sum equivalent to 20 per centum of the costs and charges involved as an administrative fee shall on demand be paid by the Grantee.
- (e) The Grantee shall procure from its parent or other associated company as shall be determined by the Director at his absolute discretion a written guarantee whereby such company unconditionally and irrevocably-
 - (i) guarantees the performance of obligations of the Grantee under this Special Condition No.(28); and
 - (ii) indemnifies the Government and F.S.I. against all losses, damages, costs, charges, expenses and liabilities which may be incurred by the Government or F.S.I. or both by reason of or arising out of any breach or non-performance of any of the obligations of the Grantee under this Special Condition No.(28).

(16) 批地文件特別批地條款第(28)條規定：

- (a) 承批人須就政府樓宇及該處各建築服務設置如有任何下列缺點、失修、不善、故障、失靈或任何其他尚未完成工程（不論乃關乎做工、物料、設計或其他），而導致或產生的所有任何性質的索償、費用、訴求、收費、損害、訴訟及法律程序向政府及財政司司長法團彌償並確保其免責：
 - (i) 於承批人交付政府樓宇或其任何部份之空置管有權當日已存在者；及
 - (ii) 承批人交付政府樓宇或其任何部份空置管有權當日後365日內（以下稱「保養期」）出現或呈現者。
- (b) 如署長或財政司司長法團或兩者要求，承批人須自費在署長或財政司司長法團或兩者指定的日期內以其指定的標準及方式進行所有保養、維修、修改、重建及糾正工程和其他任何必要工程，以補救及糾正政府樓宇或其任何部份和該處各建築服務設置於保養期內出現或呈現的缺點、失修、不善、故障、失靈或其他尚未完成工程。除上述所指之外，承批人並須自費在署長或財政司司長法團或兩者指定的該日期內以其指定的標準及方式修復及糾正政府樓宇或其任何部份和該處各建築服務設置於承批人交付管有權日已存在的缺點、失修、不善、故障、失靈或任何其他尚未完成工程。
- (c) 保養期即將屆滿前，署長或財政司司長法團或兩者將促使進行檢驗相關政府樓宇部份和該處建築服務設置，以識別任何明顯的缺點、失修、不善、故障、失靈或任何其他尚未完成工程。署長和財政司司長法團各自保留權利於保養期屆滿後14日內向承批人送達一份或多份建築瑕疵細目表，列明相關政府樓宇部份及該處建築服務設置的明顯缺點、失修、不善、故障、失靈或任何其他尚未完成工程。承批人須自費促使所有必要工程進行，以於署長或財政司司長法團或兩者指定的日期內以其指定的標準及方式補救及糾正此等缺失。
- (d) 如承批人未能進行本特別批地條款第(b)及(c)條所訂的任何工程，政府或財政司司長法團或兩者可自行進行。承批人須於接獲通知後支付經署長核證（其決定為最終決定並對承批人有約束力）為署長或財政司司長法團或兩者因此招致的所有費用及收費，另加相等於費用及收費總額百分之20的行政費。
- (e) 承批人須達致其母公司或署長全權酌情指定的其他有聯繫公司發出擔保書，承諾該公司無條件及不可撤回地：
 - (i) 擔保承批人履行本特別批地條款第(28)條的責任；及
 - (ii) 就承批人任何違反或不履行本特別批地條款第(28)條所規定的任何責任而導致署長或財政司司長法團或兩者招致的所有損失、損害、費用、收費、開支及責任承批人須向政府及財政司司長法團彌償並確保其免責。

The guarantee shall be subject to the laws of Hong Kong in a form to be approved by the Director and shall be delivered to him within 30 days from the date of this Agreement or within such other extended period or periods as may be approved by the Director. If the Grantee has a parent or associated company incorporated outside of Hong Kong and if required by the Director or F.S.I. or both the Grantee shall procure and furnish to the Director a performance bond or guarantee in a form acceptable in all respects to the Director to be given by a bank licensed under section 16 of the Banking Ordinance. Such bond or guarantee shall be for such sum as the Director may decide (the decision of the Director to the sum shall be final and binding on the Grantee) for the purpose of securing payment to the Government or F.S.I. or both of any sum which shall have been demanded under sub-clause (d) of this Special Condition and has not been paid by the Grantee to the Government or F.S.I. or both.

- (f) For the purpose of this Special Condition only, the expression "Grantee" shall include the assignees whose title is derived from the Grantee under Special Condition No.(55) hereof, but otherwise exclude his assigns.

(17) Special Condition No.(29) stipulates that:

The Grantee shall, at his own expense and as soon as practicable but no later than 8 weeks from the date of delivery of possession by the Grantee of the Government Accommodation, provide to the Director all documents, drawings and materials relating thereto in accordance with the requirement of the Technical Schedule.

(18) Special Condition No.(30) stipulates that:

- (a) The Grantee shall throughout the term hereby agreed to be granted at his own expense and in all respects to the satisfaction of the Director maintain the following items (hereinafter referred to as "the Items"):-
- (i) the external finishes of the Government Accommodation and the structure of all walls, columns, beams, ceilings, roof slabs, carriageway/floor slabs and any other structural elements of, in, around, within, above and below the Government Accommodation;
 - (ii) all lifts, escalators and stairways serving the Government Accommodation and the remainder of the development on the lot;
 - (iii) all building services installations, plant and equipment (including but not limited to portable and non-portable fire services installation equipment) forming part of the system serving the Government Accommodation and the remainder of the development on the lot;
 - (iv) all other common parts and facilities serving the Government Accommodation and the remainder of the development on the lot.
- (b) The Grantee shall indemnify and keep indemnified the Government and F.S.I. against all liabilities, damages, expenses, claims, costs, demands, charges, actions and proceedings of whatsoever nature arising out of or as a consequence of the failure of the Grantee to maintain the Items.
- (c) For the purpose of this Special Condition only, the expression "Grantee" shall exclude F.S.I..

(19) Special Condition No.(31) stipulates that:

- (a) There are excepted and reserved unto the Government, its lessees, tenants, licensees and occupiers (hereinafter collectively referred to as "the Successors In Title") for the time being of the Mini Transport Interchange Reserved Area or any part thereof:
- (i) the rights of support and occupation over the lot at such positions, in such manner, with such materials and to such standards, levels, alignment and design as may be determined by the Director for the construction and maintenance of all supporting structures and connections to the mini transport interchange constructed or to be constructed within the Mini Transport Interchange Reserved Area, and the Grantee shall ensure that no structure or building within the lot will obstruct, interfere with or prejudice the construction or maintenance of any supporting structures or connections to the mini transport interchange;
 - (ii) the rights of shelter support and protection from the lot for such parts of the Mini Transport Interchange Reserved Area as required, and such rights of shelter support and protection over the lot shall be as decided by the Director whose decision shall be final and binding on the Grantee;

上述擔保書須遵從香港法律，並採用署長批准的格式，於本協議簽訂日30天或署長批准的其他一段或多段延長日期內交付署長。如承批人的母公司或有聯繫公司於香港境外註冊，又如署長或財政司司長法團或兩者要求，承批人須達致提交署長由根據《銀行業條例》第16條持牌的銀行簽發而格式全面符合署長要求的履約保證書或擔保書。該履約保證書或擔保書的金額為署長決定（其決定為最終決定並對承批人有約束力），用於確保向署長或財政司司長法團或兩者支付已根據本特別批地條款第(d)條發出通知應繳惟承批人尚未清繳予署長或財政司司長法團或兩者的任何款項。

- (f) 就本特別批地條款而言，「承批人」一詞包括本文特別批地條款第(55)條所載的承批人但不包括其受讓人。

(17) 批地文件特別批地條款第(29)條規定：

承批人須於向政府交付政府樓宇的管有權日後在切實可行的時間內惟不遲於8星期內，自費向署長提交遵照工程規格附表規定所有的文件、圖則及材料。

(18) 批地文件特別批地條款第(30)條規定：

- (a) 承批人須在整個批地年期內，自費以達致署長全面滿意保養以下項目（以下稱「該等物件」）：
- (i) 政府樓宇的外飾面及政府樓宇之內、周圍、其中、其上及其下所有牆、柱、樑、天花、天台板、車道或地台板結構和任何其他結構項件；
 - (ii) 所有供政府樓宇及該地段發展項目其餘部份使用的電梯、自動扶手電梯及樓梯；
 - (iii) 構成供政府樓宇及該地段發展項目其餘部份的系統一部份的所有建築物服務設置、機器及設備（包括但不限於手提式及非手提式消防裝置設備）；
 - (iv) 所有其他供政府樓宇及該地段發展項目其餘部份使用的公用部份及設施。
- (b) 承批人須就其未能保養該等物件而導致或招致的所有及任何性質的責任、損害、開支、索償、費用、訴求、收費、訴訟及法律程序向政府及財政司司長法團彌償並確保其免責。
- (c) 於本特別批地條款而言，「承批人」之釋義不包括財政司司長法團。

(19) 批地文件特別批地條款第(31)條規定：

- (a) 政府、其承租人、租客、持牌人及佔用人（以下統稱「所有權繼承人」）現獲例外保留小型交通運輸交匯處專用範圍或其任何部份：
- (i) 其權利從該地段，於署長決定的位置、方式、物料、標準、水平、定線及設計獲得支承與佔用，以便建造及保養於小型交通運輸交匯處專用範圍內現有或將會建造的小型交通運輸交匯處的所有支承結構物及連接物。承批人須確保該地段內沒有任何結構物或建築物對小型交通運輸交匯處的支承結構物或連接物的建造或保養構成干擾、妨礙或侵害；
 - (ii) 其權利以於需要時從該地段獲得庇護、支承及保護小型交通運輸交匯處專用範圍及其該等部份，而此可從該地段獲庇護、支承及保護權利由署長決定而其決定為最終決定並對承批人有約束力；

- (iii) the right to enter upon the lot with or without tools, equipment, plant, machinery or motor vehicles for the purpose of connecting, constructing, inspecting, maintaining, repairing and renewing the mini transport interchange and the structures and installations supporting or appurtenant to the mini transport interchange;
- (iv) the rights of such easements, and rights of way through and over the lot and any buildings or structures erected or to be erected on the lot to and from the Mini Transport Interchange Reserved Area and any part or parts thereof and the structures and installation supporting or appurtenant to the Mini Transport Interchange Reserved Area as decided by the Director whose decision shall be final and binding on the Grantee; and
- (v) the rights of passage of gas, electricity, water, drainage or other effluent, air, telephone lines and other services to and from the Mini Transport Interchange Reserved Area and any part or parts thereof through any gutters, pipes, wires, cables, sewers, drains, ducts, flues, conduits and watercourses and other conducting media laid or to be laid or running along, through, over, upon, under or in the lot or any buildings, structures and erections on the lot.
- (b) Neither the Grantee nor any other person shall make objection to or have any right or claim to compensation against the Government whatsoever whether under any enactment or otherwise in respect of the exception and reservation under sub-clause (a) of this Special Condition or in respect of any liabilities, losses, damages, claims, costs, actions, demands and proceedings of whatsoever nature howsoever caused arising out of or as a consequence of the use of the Mini Transport Interchange Reserved Area as the mini transport interchange for vehicular traffic or otherwise.
- (c) The Government, its officers, agents, contractors and workmen or other duly authorized personnel shall have no liability in respect of any loss, damage, nuisance or disturbance whatsoever caused to or suffered by the Grantee or any other person arising out of or incidental to the exercise by it or them of the rights conferred under sub-clause (a) of this Special Condition or arising out of the maintenance, presence or operation of the mini transport interchange, and no claim shall be made against it or them by the Grantee in respect of any such loss, damage, nuisance or disturbance.
- (d) The Grantee acknowledges and agrees that the Government in no way warrants under this Special Condition that the mini transport interchange will be constructed in the future and shall be under no liability whatsoever to the Grantee for any loss or damage howsoever arising in connection therewith or as a consequence thereof if the mini transport interchange will not be constructed in the future.
- (e) Without prejudice to the rights of Government under Special Condition No.(31)(a) hereof, upon obtaining the prior written consent of the Director, the Grantee may at his cost and expense erect within the Mini Transport Interchange Reserved Area such walls and supporting structures for any building or structures erected or to be erected within the lot as the Director may approve from time to time, provided that:
- (i) the Grantee shall at his cost and expense repair, maintain, replace, renew, remove and demolish such walls and supporting structures as the Director may from time to time require in his discretion whose decision is final and binding upon the Grantee, and
- (ii) the Grantee shall indemnify, and keep indemnified the Government and the Successors In Title against all claims, costs, demands, charges, damages, actions and proceedings of whatsoever nature arising out of or in connection with the erection, repair, maintenance, replacement, renewal, removal and demolition of such walls and supporting structures.
- (iii) 其權利進入該地段，不論有否帶同工具、設備、機器、器械或車輛，以便連接、建造、視察、保養、修理及翻新小型交通運輸交匯處及其支承或從屬結構與裝置；
- (iv) 其權利享有該地段及現已或將會興建於該地段上任何建築物或結構物的所有必要地役權及通行權，以便往來小型交通運輸交匯處專用範圍及其任何一部份或多部份及其內各支承或從屬結構與裝置，而此權利由署長決定而其決定為最終決定並對承批人有約束力；
- (v) 其權利透過現時或往後鋪設於該地段或該地段上任何建築物、結構物及興建物或跟著、穿過、越過跨過或其下該處之任何溝渠、水管、電線、電纜、污水管、排水渠、管槽、排煙道、管道及水道和其他導體而享用接駁至小型交通運輸交匯處專用範圍及其任何部份的氣體、電力、水、污水或其他污水排放、空氣、電話線及其他服務。
- (b) 承批人或任何其他人士均不得就本特別批地條款第(a)條的例外保留權利，或就此或就著使用小型交通運輸交匯處專用範圍作車輛行使等用途之小型交通運輸交匯處所導致或招致的任何性質的責任、損失、損害、索償、費用、訴訟、訴求及法律程序，作出反對或向政府提出不論是否在任何法例下申索或索償。
- (c) 倘因政府、其人員、代理、承辦商及工人或其他獲授權人員或其一或多方行使本特別批地條款第(a)條權利或處理附帶於此等權利之事宜，或因小型交通運輸交匯處進行保養、其存在或運作令承批人或任何其他人士導致或產生任何損失、損害、滋擾或騷擾，政府、其人員、代理、承辦商及工人或其他獲授權人員概毋須就此承擔責任，承批人不得就任何此等損失、損害、滋擾或騷擾向彼等任何一方索償。
- (d) 承批人確認及同意政府概不憑藉本特別批地條款作出保證日後將會興建小型交通運輸交匯處。倘若日後不興建該小型交通運輸交匯處而因此導致承批人產生任何損失或損害，政府毋須就此承擔任何責任。
- (e) 茲毋損本文特別批地條款第(31)(a)條所賦予政府的權利，承批人可於獲得署長事先批准，自費於小型交通運輸交匯處專用範圍內興建任何現已或將會興建於該地段內經署長批准的建築物或結構物的牆壁及支承結構，惟須遵從以下條件：
- (i) 承批人須於署長任何時間要求下自費維修、保養、更換、更新、移除、及拆卸該牆壁及支承結構，而署長的決定為最終決定並對承批人有約束力；及
- (ii) 承批人須向政府及其所有權繼承人就因興建、維修、保養、更換、更新、移除、及拆卸該牆壁及支承結構而導致或產生任何性質之索償、費用、訴求、收費、損害、訴訟及法律程序作出彌償並確保其免責。

(20) Special Condition No.(38) stipulates that:

- (a) The Grantee shall at his own expense and in all respects to the satisfaction of the Director lay, form, provide, construct and surface such segregated pedestrian ways or paths (together with such stairs, ramps, lightings and escalators as the Director in his absolute discretion may require) for the purposes as specified in the sub-clause (b) of this Special Condition at such positions, in such manner, with such materials and to such standards, levels, alignment and designs as the Director shall approve.
- (b) The segregated pedestrian ways or paths referred to in sub-clause (a) of this Special Condition shall follow the shortest possible routes and shall be covered and constructed and designed so as to:
 - (i) link up each and every building to be erected on the lot at such locations and levels of the building as the Director shall approve; and
 - (ii) link up all major facilities within the lot including the shops, residential blocks, open space and community facilities provided thereon.
- (c) The Grantee shall throughout the whole term hereby agreed to be granted maintain at his own expense the segregated pedestrian ways or paths (together with such stairs, ramps, lightings and escalators) required to be provided under this Special Condition in good and substantial condition and repair to the satisfaction of the Director.
- (d) The Grantee shall on or before the date specified in Special Condition No.(13) hereof (or within such other date or extended period as may be approved by the Director) at his own expense and in all respects to the satisfaction of the Director, at such locations, levels, routing and alignment, in such manner and design, with such materials, to such standard and in such stages as may be approved by the Director, construct and provide within the lot a pedestrian walkway with a minimum clear width of 3 metres together with such escalators, stairways, ramps, lifts and such other associated structures as may be approved or required by the Director (hereinafter referred to as "the Pedestrian Walkway") for the purposes of linking up the public roads and footpaths adjoining or near the lot, the Government Accommodation, mini transport terminus (if any) and future adjoining development (if any) on the south-eastern side of the lot.
- (e) The Grantee shall throughout the term hereby agreed to be granted maintain at his own expense the Pedestrian Walkway in good and substantial condition and repair to the satisfaction of the Director.
- (f) The Grantee shall throughout the whole term hereby agreed to be granted at all times during day and night or such other hours as may be approved by the Director keep the Pedestrian Walkway open for use by the public free of charge without any interruption.

(21) Special Condition No.(39) stipulates that:

The Grantee shall on or before the date specified in Special Condition No.(13) hereof or such other extended period as may be approved by the Director at his own expense, with such materials and to such standards, levels, alignment, disposition and design as shall be required or approved by the Director (including but not limited to the provision and construction of such supports, ramps, associated staircases and landings, escalators, lifts and such internal and external fittings and fixtures and such lighting fittings as the Director in his sole discretion may require) provide and construct such supports and connections within the lot and the building or buildings erected or to be erected thereon between the points R and S shown and marked on PLAN I or such other points and at such levels as the Director may require.

(20) 批地文件特別批地條款第(38)條規定：

- (a) 承批人須自費按署長批准的該位置、方式、物料、標準、水平、定線和設計並全面令署長滿意，於該地段鋪設、構造、提供、建造和平整路面分段行人路或行人道（連同署長全權酌情要求的樓梯、斜路、照明裝置及自動扶手電梯），以作本特別批地條款第(b)條指明的用途。
- (b) 本特別批地條款第(a)條所指的分段行人路或行人道須採取最短路線並含上蓋，建造及設計應符合以下要求：
 - (i) 於署長批准的位置和建築物的水平連通將會興建於該地段上每幢建築物；及
 - (ii) 連通該地段內所有主要設施，包括商業樓宇、住宅大廈、開放空間及社區設備。
- (c) 承批人須在本文協定的整個批地年期內自費保養本特別批地條款規定其提供的分段行人路或行人道（連同該處之樓梯、斜路、照明裝置及自動扶手電梯），以保持其修葺良好堅固和狀況良好令署長滿意。
- (d) 承批人須於本文特別批地條款第(13)條所訂明的日期或之前（或署長批准的該其他日期或延長日期內）自費按照署長批准的位置、水平、路線、定線，以及該方式、設計、物料、標準及階段，建造及提供最小淨闊度3米的行人走道，連同該處之自動扶手電梯、樓梯、斜路、電梯及其他由署長批准或要求的附屬結構（以下稱「行人走道」），以連接毗鄰或該地段附近的公共道路及行人路、政府樓宇、小型公共運輸交匯處（如有）及將來毗鄰該地段東南方的發展項目（如有）。
- (e) 承批人須於本文協定的整個批地年期內自費保養行人走道，以保持其修葺良好堅固和狀況良好令署長滿意。
- (f) 承批人須於本文協定的批地年期內的所有時間於日與夜或署長批准的該等其他時間內保持行人走道開放予公眾免費使用且不受任何中斷。

(21) 批地文件特別批地條款第(39)條規定：

承批人須在本文特別批地條款第(13)條所訂明的日期或之前或署長批准的其他延長日期，自費以署長批准的物料、標準、水平、定線、布局及設計（包括但不限於署長全權酌情要求提供及建造支承件、斜路、相關的樓梯及平台、自動扶手電梯、電梯及內外配件及固定裝置與照明裝置）於該地段及現已有或將會興建的一幢或多幢建築物提供及建造支承件及連接點以連接批地文件所夾附圖則I所標示的R點和S點或其他由署長要求的地點及水平。

G. Provisions of every deed of mutual covenant that concern those facilities and open spaces, and those parts of the land

(1) The definitions of the Deed of Mutual Covenant stipulate that :
In this Deed the following expressions shall have the following meanings except where the context otherwise permits or requires:

"Government Accommodation" means one public transport terminus on the ground floor (including lighting fixtures, ventilation plant, extract ductworks and road/floor surfaces but excluding such lifts, escalators, stairways, plant, equipment and other facilities not serving exclusively thereto as may be permitted by the Director of Lands in accordance with the Government Grant, walls, columns, beams, ceilings, roof slabs, carriageway/floor slabs and any other structural elements) together with any other areas, facilities, services and installations exclusive thereto as the Director of Lands may in his absolute discretion determine (whose determination shall be conclusive and binding on all Owners) as referred to in Special Condition No.(18)(a) of the Government Grant which for the purpose of identification only are shown and coloured brown on the plans annexed to the Deed of Mutual Covenant.

"Green Area" means the Green Area referred to and defined in Special Condition No.(5)(a)(i)(I) of the Government Grant.

"Green Area Structures" means the Green Area Structures referred to and defined in Special Condition No.(5)(a)(i)(II) of the Government Grant.

"Green Stippled Black Area" means the Green Stippled Black Area referred to and defined in Special Condition No.(5)(b)(i)(I) of the Government Grant.

"Green Stippled Black Area Structures" means the Green Stippled Black Area Structures referred to and defined in Special Condition No.(5)(b)(i)(II) of the Government Grant.

"Items" means collectively (i) the external finishes of the Government Accommodation and the structure of all walls, columns, beams, ceilings, roof slabs, carriageway/floor slabs and any other structural elements of, in, around, within, above and below the Government Accommodation, (ii) all lifts, escalators and stairways serving the Government Accommodation and the remainder of the Estate, (iii) all building services installations, plant and equipment (including but not limited to portable and non-portable fire services installation equipment) forming part of the system serving the Government Accommodation and the remainder of the Estate, and (iv) all other common parts and facilities serving the Government Accommodation and the remainder of the Estate as referred to in Special Condition No.(30)(a) of the Government Grant.

"Mini Transport Interchange Reserved Area" means the excluded stratum of land and airspace in the areas referred to and defined in the First Schedule to the Government Grant and including all that strip of the external walls of the Estate with the thickness of 30mm from the internal/interior of such external walls with its location and dimension for the purpose of identification only as shown and coloured indigo hatched black triangulated black on the plan(s) annexed to the Deed of Mutual Covenant.

"Pedestrian Walkway" means the 24-hour pedestrian walkway referred to and defined in Special Condition No.(38)(d) of the Government Grant, parts of which form part of the Estate Common Areas which for identification purpose only are shown and coloured red double hatched black on the plan annexed to the Deed of Mutual Covenant and the remaining parts of which form part of the Commercial Development which for identification purpose only are shown and coloured indigo double hatched black on the plans annexed to the Deed of Mutual Covenant.

G. 指明住宅物業的每一公契中關於該等設施、休憩用地及土地中的該等部分的條文

(1) 公契的定義規定：
在本公契中，除文意允許或另有規定外，以下詞語具有以下含義：

「政府樓宇」是指及應批地文件特別批地條款第(18)(a)條所指地面樓層上的一個公共運輸交匯處（包括照明裝置、通風系統、抽風管道及道路/地平面但不包括電梯、自動扶手電梯、樓梯、機器、設備及並不專屬於該處所而地政總署署長可根據批地文件批准的其他設施、牆壁、樁柱、基腳、天花板、屋頂面板、車行通道/地面平板及任何其他支承件）連同任何範圍、設施、服務及裝置均專屬該處而地政總署署長全權酌情決定（其決定為最終的決定及對所有擁有人具有約束力），其位置以啡色顯示於公契所夾附的圖則。

「綠色範圍」是指及應批地文件特別批地條款第(5)(a)(i)(I)條所指的綠色範圍所定義。

「綠色範圍構築物」是指及應批地文件特別批地條款第(5)(a)(i)(II)條所指的綠色範圍構築物所定義。

「綠色加黑點範圍」是指及應批地文件特別批地條款第(5)(b)(i)(I)條所指的綠色加黑點範圍所定義。

「綠色加黑點範圍構築物」是指及應批地文件特別批地條款第(5)(b)(i)(II)條所指的綠色加黑點範圍構築物所定義。

「該等物件」是批地文件特別批地條款第(30)(a)條所統稱指(i)政府樓宇的外飾面及政府樓宇之內、周圍、其中、其上及其下所有牆、柱、樑、天花、天台板、車道或地台板結構和任何其他結構項件；(ii)所有供政府樓宇及屋苑其餘部份使用的電梯、自動扶手電梯及樓梯；(iii)構成供政府樓宇及屋苑其餘部份的系統一部份的所有建築物服務設置、機器及設備（包括但不限於手提式及非手提式消防裝置設備）；及(iv)所有其他供政府樓宇及屋苑其餘部份使用的公用部份及設施。

「小型交通運輸交匯處專用範圍」是指及應批地文件附表一所定義之被排除的地層及空域範圍及包括所有屋苑的該外牆由其內部/室內的30毫米厚度，其位置及尺寸以藍色加斜黑線加黑色三角顯示於公契所夾附的圖則。

「行人走道」是指及應批地文件特別批地條款第(38)(d)條所指的24小時行人走道，部份於公契所夾附的圖則以紅色加雙斜黑線顯示構成屋苑公用地方，其餘部份以藍色加雙斜黑線顯示構成商業發展項目。

- (2) Clause 3 of the Deed of Mutual Covenant stipulates that:
Each Undivided Share and the sole and exclusive right and privilege to hold, use, occupy and enjoy any part of the Estate shall be held by the Owner from time to time of such Undivided Share subject to and with the benefit of the easements, rights, privileges and obligations provided in the SECOND SCHEDULE hereto, and the covenants and provisions contained in this Deed. For the avoidance of doubt, no Owner shall make objection to or have any right or claim to compensation against the Government whatsoever whether under any enactment or otherwise in respect of the exercise of the rights and privileges reserved under Part B(c) of the SECOND SCHEDULE or in respect of any liabilities, losses, damages, claims, costs, actions, demands and proceedings of whatsoever nature howsoever caused arising out of or as a consequence of the use of the Mini Transport Interchange Reserved Area as the mini transport interchange (if any) for vehicular traffic or otherwise or arising out of the maintenance, presence or operation of the mini transport interchange (if any).
- (3) Clause 10(d) of the Deed of Mutual Covenant stipulates that:
F.S.I. as Owner of the Government Accommodation shall not be liable to contribute any Management Charges in respect of the remainder of the Estate and in particular shall not be liable for payment of any Management Charges whatsoever incurred in respect of the Common Areas and Facilities, including the Items.
- (4) Clauses 13(c)(xx), (xxi), (xxiii), (xxiv), (xxv) and (xxix) of the Deed of Mutual Covenant stipulate that:
The Management Expenses shall cover all expenditure which is to be necessarily and reasonably incurred for the proper good and efficient management and maintenance of the Lot and the Estate (excluding the Government Accommodation) and the Common Areas and Facilities therein including but without prejudice to the generality of the foregoing the following costs charges and expenses:
(xx) all costs and expenses incurred in connection with maintaining the Green Area together with the Green Area Structures and all structures, surfaces, gullies, sewers, drains, fire hydrants, services, street lights, traffic signs, street furniture, road markings and plant constructed, installed and provided thereon or therein in accordance with the Government Grant (until possession of the Green Area is re-delivered to the Government) in observing and complying with Special Condition No.(5)(a)(iii) of the Government Grant.
(xxi) all costs and expenses incurred in connection with maintaining the Green Stippled Black Area together with the Green Stippled Black Area Structures and all structures, surfaces, gullies, sewers, drains, fire hydrants, services, street lights, traffic signs, street furniture, road markings and plant constructed, installed and provided thereon or therein in accordance with the Government Grant (until possession of the Green Stippled Black Area is re-delivered to the Government) in observing and complying with Special Condition No.(5)(b)(iii) of the Government Grant.
(xxiii) all costs and expenses incurred in connection with managing and maintaining the Items which are the obligations of the Owners (save and except F.S.I. as Owner of the Government Accommodation) in observing and complying with Special Condition No.(30)(a) of the Government Grant.
(xxiv) all costs and expenses incurred in connection with keeping and maintaining the pedestrian link in the design as Covered Walkway and the Pedestrian Walkway which form parts of the Common Areas and Facilities in accordance with Special Condition Nos.(38)(c) and (38)(e) of the Government Grant.
(xxv) all costs and expenses incurred in connection with keeping such parts of the Pedestrian Walkway forming part of the Common Areas and Facilities open for the lawful purpose without interruption in compliance with Special Condition No.(38)(f) of the Government Grant.
(xxix) all costs and expenses incurred in connection with repairing, maintaining, replacing, renewing, removing and demolishing such part or parts of the walls and supporting structures erected within the Mini Transport Interchange Reserved Area and not forming part of the Commercial Development in accordance with Special Condition No.(31)(e)(i) of the Government Grant.
- (2) 公契第3條規定：
每一不分割份數及擁有、使用、佔用及享用屋苑任何一部份之完整專有權利及特權，將由該不分割份數其不時有此等權利之業主，在受制及受益於本契據附表二所載列之權利和特權及本文所述的明文責任、契諾及條文下持有。為免存疑，任何擁有人均不得就附表二之B部份第(c)條的例外保留權利，或就此或就著使用小型交通運輸交匯處專用範圍作車輛行使等用途之小型交通運輸交匯處（如有）或因小型交通運輸交匯處（如有）進行保養、其存在或運作所導致或招致的任何性質的責任、損失、損害、索償、費用、訴訟、訴求及法律程序，作出反對或向政府提出不論是否在任何法例下申索或索償。
- (3) 公契第10(d)條規定：
財政司司長法團作為政府樓宇的擁有人並沒有責任支付關於屋苑其餘部份的任何管理費用，及特別並沒有責任支付關於屋苑公用地方及設施，包括該等物件的任何管理費用。
- (4) 公契第13(c)(xx)、(xxi)、(xxiii)、(xxiv)、(xxv)及(xxix)條規定：
管理開支須包括為了良好和有效率地管理和保養該地段、屋苑（不包括政府樓宇）及公用地方及設施而必要及合理地招致的所有支出，包括但在不影響前述條文一般性的原則下以下各項費用、收費及支出：
(xx) 為符合及履行根據批地文件特別批地條款第(5)(a)(iii)條保養綠色範圍連同綠色範圍構築物及在該處上及內建造、裝設及提供的所有結構物、路面、溝渠、污水管、排水渠、消防栓、服務設施、街燈、交通標誌、街道設施、道路標記及植物(直至交還綠色範圍的管有予政府)所招致的所有費用及開出。
(xxi) 為符合及履行根據批地文件特別批地條款第(5)(b)(iii)條保養綠色加黑點範圍連同綠色加黑點範圍構築物及在該處上及內建造、裝設及提供的所有結構物、路面、溝渠、污水管、排水渠、消防栓、服務設施、街燈、交通標誌、街道設施、道路標記及植物（直至交還綠色加黑點範圍的管有予政府）所招致的所有費用及開出。
(xxiii) 為符合及履行根據批地文件特別批地條款第(30)(a)條為擁有人（財政司法團作為政府物業擁有人除外）有責任管理及保養該等物件所招致的所有費用及開支。
(xxiv) 為根據批地文件特別批地條款第(38)(c)條及(38)(e)條保持及保養設計為有蓋行人路的連通行人路及行人走道其構成公用地方及設施之一部份，所招致的所有費用及開支。
(xxv) 為履行根據批地文件特別批地條款第(38)(f)條保持構成公用地方及設施之一部份的行人走道24小時開放且不受任何中斷作合法目的。
(xxix) 為根據批地文件特別批地條款第(31)(e)(i)條維修、保養、更換、翻新、移除及拆卸興建於小型交通運輸交匯處專用範圍內而不構成商業發展項目的該或該等牆壁及支承結構所招致的所有費用及開支。

- (5) Clauses 37(bv), (bw), (bx), (bz), (ca), (cb) and (cl) of the Deed of Mutual Covenant stipulates that:
Subject to the provisions of the Building Management Ordinance, the Manager shall have the authority to do all such acts and things as may be necessary or expedient for the management of the Estate (excluding the Government Accommodation) for and on behalf of all Owners (excluding F.S.I.) in accordance with the provisions of this Deed and each Owner (excluding F.S.I.) hereby irrevocably APPOINTS the Manager as agent in respect of any matter concerning the Common Areas and Facilities and all other matters duly authorised under this Deed. The Manager shall not represent F.S.I. or the Government Property Administrator in any dealings with the Government. In addition to the other powers expressly provided in this Deed, the Manager shall have full and unrestricted authority but subject to the provisions of the Ordinance to do all such acts and things as may be necessary or expedient for or in connection with the management of the Lot and the Estate (excluding the Government Accommodation) including in particular the following but without in any way limiting the generality of the foregoing provided that such powers and duties of the Manager shall be subject to the rights and privileges of F.S.I. and shall not in any way adversely affect or prejudice the rights, easements and privileges reserved to F.S.I. in this Deed and the Government Grant:-
- (bv) To maintain on behalf of the Owners the Green Area together with the Green Area Structures and all structures, surfaces, gullies, sewers, drains, fire hydrants, services, street lights, traffic signs, street furniture, road markings and plant constructed, installed and provided thereon or therein in accordance with the Government Grant (to the extent that the Green Area has not yet been re-delivered to the Government) in observing and complying with Special Condition No.(5)(a)(iii) of the Government Grant.
- (bw) To maintain on behalf of the Owners the Green Stippled Black Area together with the Green Stippled Black Area Structures and all structures, surfaces, gullies, sewers, drains, fire hydrants, services, street lights, traffic signs, street furniture, road markings and plant constructed, installed and provided thereon or therein in accordance with the Government Grant (to the extent that the Green Stippled Black Area has not yet been re-delivered to the Government) in observing and complying with Special Condition No.(5)(b)(iii) of the Government Grant.
- (bx) To have the right to represent all the Owners in all matters and dealings with the Government or any statutory body or any utility or other competent authority or any other person whomsoever in any way touching or concerning the Green Area or the Green Area Structures or the Green Stippled Black Area or the Green Stippled Black Area Structures (until possession of which is re-delivered to the Government) Provided that the Manager shall not represent F.S.I. or the Government Property Administrator in any dealings with the Government.
- (bz) To manage and maintain the Items which are the obligations of the Owners (save and except F.S.I. as Owner of the Government Accommodation) in accordance with Special Condition No.(30)(a) of the Government Grant.
- (ca) To keep and maintain the pedestrian link in the design as Covered Walkway and the Pedestrian Walkway which form parts of the Common Areas and Facilities in accordance with Special Condition Nos.(38)(c) and (38)(e) of the Government Grant.
- (cb) To keep such parts of the Pedestrian Walkway forming part of the Common Areas and Facilities open for all lawful purposes free of charge and without interruption in compliance with Special Condition No.(38)(f) of the Government Grant Provided that the Pedestrian Walkway or any part(s) thereof may be closed for maintenance and/or repair for such period subject to the approval in writing by the Director of Lands.
- (cl) To repair, maintain, replace, renew, remove and demolish such part or parts of the walls and supporting structures erected within the Mini Transport Interchange Reserved Area and not forming part of the Commercial Development in accordance with Special Condition No.(31)(e)(i) of the Government Grant.
- (6) Clause 79 of the Deed of Mutual Covenant stipulates that:
The Owners (which expression shall for the purpose of this Sub-clause exclude F.S.I. as Owner of the Government Accommodation), acting by the Manager, shall throughout the whole of the term of the Government Grant at their own expense and in all respects to the satisfaction of the Director of Lands manage and maintain the Items and shall indemnify and keep indemnified the Government and F.S.I. against all liabilities, damages, expenses, claims, costs, demands, charges, actions and proceedings of whatsoever nature arising out of or as a consequence of the failure to manage and maintain the Items.
- (5) 公契第37(bv)、(bw)、(bx)、(bz)、(ca)、(cb)及(cl)條規定：
受限於《建築物管理條例》，管理人有權代表所有擁有人（不包括財政司司長法團）根據本公契就必要或適宜管理屋苑（不包括政府樓宇）而作出所有相關行為及事情，每位業主（不包括財政司司長法團）在此不得撤回地委任管理人作為代理人處理有關任何涉及公用地方及設施的事情。管理人不能代表財政司司長法團或政府產業署署長與政府作任何協約。除了本公契明確規定的其他權力外，惟受《建築物管理條例》監管，管理人擁有充分及不受限制的權限為妥善管理該地段及屋苑（不包括政府樓宇）作出所有必要或適宜的行為和事情，在任何方面不影響前述條文一般性的原則下包括：
- (bv) 為符合及履行批地文件特別批地條款第(5)(a)(iii)條代表所有業主保養綠色範圍連同綠色範圍構築物及在該處上及內建造、裝設及提供的所有結構物、路面、溝渠、污水渠、排水渠、消防栓、服務設施、街燈、交通標誌、街道設施、道路標記及植物（在綠色範圍尚未交還予政府的情況下）。
- (bw) 為符合及履行批地文件特別批地條款第(5)(b)(iii)條代表所有業主保養綠色加黑點範圍連同綠色加黑點範圍構築物及在該處上及內建造、裝設及提供的所有結構物、路面、溝渠、污水渠、排水渠、消防栓、服務設施、街燈、交通標誌、街道設施、道路標記及植物（在綠色加黑點範圍尚未交還予政府的情況下）。
- (bx) 有權力代表所有業主與政府或任何法定機構或公共事業公司或其他主管當局或任何其他人士處理任何所有觸及或關於綠色範圍或綠色範圍構築物或綠色加黑點範圍或綠色加黑點範圍構築物（直至其管有交還予政府）然而管理人不能代表財政司司長法團或政府產業署署長與政府作任何協約。
- (bz) 根據批地文件特別批地條款第(30)(a)條管理及保養為擁有人（不包括財政司法團作為政府樓宇的擁有人）需負責任的該等物件。
- (ca) 根據批地文件特別批地條款第(38)(c)條及(38)(e)條保持及保養設計為有蓋行人路的連通行人路及行人走道其構成公用地方及設施之一部份。
- (cb) 根據批地文件特別批地條款第(38)(f)條保持構成公用地方及設施之一部份的行人走道24小時開放且不受任何中斷作合法目的，然而行人走道或其部份於受制於地政總署署長書面批核下可於該時段關閉作保養及/或維修。
- (cl) 根據批地文件特別批地條款第(31)(e)(i)條維修、保養、更換、翻新、移除及拆卸興建於小型交通運輸交匯處專用範圍內而不構成商業發展項目的該或該等牆壁及支承結構。
- (6) 公契第79條規定：
擁有人（為本條款中所指不包括財政司法團作為政府樓宇的擁有人），需於整個政府批地年期由管理人代表自費並符合地政總署署長全面滿意管理及保養該等物件及須就其未能管理及保養該等物件而導致或招致的所有及任何性質的責任、損害、開支、索償、費用、訴求、收費、訴訟及法律程序向政府及財政司司長法團彌償並確保其免責。

- (7) Clause 80 of the Deed of Mutual Covenant stipulates that:
The Owner(s) of the Commercial Development shall, at their own expense, be responsible for maintaining the parts of the Pedestrian Walkway forming parts of the Commercial Development in good and substantial condition and repair and in all respects to the satisfaction of the Director of Lands in accordance with Special Condition No.(38)(e) of the Government Grant and shall keep such parts of the Pedestrian Walkway as is or may be constructed within the Commercial Development open for all lawful purposes free of charge and without any interruption in compliance with Special Condition No.(38)(f) of the Government Grant Provided that the Pedestrian Walkway or any part(s) thereof may be closed for maintenance and/or repair for such period subject to the approval in writing by the Director of Lands.
- (8) Clause 88 of the Deed of Mutual Covenant stipulates that:
The Owner(s) of the Commercial Development shall, at their own expense, be responsible for repairing, maintaining, replacing, renewing, removing and demolishing such part or parts of the walls and supporting structures erected within the Mini Transport Interchange Reserved Area forming part of the Commercial Development in accordance with Special Condition No.(31)(e)(i) of the Government Grant and to observe and comply with Special Condition No.(31)(e)(ii) of the Government Grant.
- (9) Paragraph (c) of Part B of the Second Schedule to the Deed of Mutual Covenant stipulates that:
The right and privilege of the Government, its lessees, tenants, licensees and occupiers ("the Successors In Title") for the time being of the Mini Transport Interchange Reserved Area or any part thereof:-
- (i) The rights of support and occupation over the Lot at such positions, in such manner, with such materials and to such standards, levels, alignment and design as may be determined by the Director of Lands for the construction and maintenance of all supporting structures and connections to the mini transport interchange constructed or to be constructed within the Mini Transport Interchange Reserved Area, and the Owners shall ensure that no structure or building within the Lot will obstruct, interfere with or prejudice the construction or maintenance of any supporting structures or connections to the mini transport interchange.
 - (ii) The rights of shelter support and protection from the Lot for such parts of the Mini Transport Interchange Reserved Area as required, and such rights of shelter support and protection over the Lot shall be as decided by the Director of Lands whose decision shall be final and binding on the Owners.
 - (iii) The right to enter upon the Lot with or without tools, equipment, plant, machinery or motor vehicles for the purpose of connecting, constructing, inspecting, maintaining, repairing and renewing the mini transport interchange and the structures and installations supporting or appurtenant to the mini transport interchange.
 - (iv) The rights of such easements, and rights of way through and over the Lot and the Estate to and from the Mini Transport Interchange Reserved Area and any part or parts thereof and the structures and installation supporting or appurtenant to the Mini Transport Interchange Reserved Area as decided by the Director of Lands whose decision shall be final and binding on the Owners.
 - (v) The right of passage of gas, electricity, water, drainage or other effluent, air, telephone lines and other services to and from the Mini Transport Interchange Reserved Area and any part or parts thereof through any gutter, pipes, wires, cables, sewers, drains, ducts, flues, conduits and watercourses and other conducting media laid or to be laid or running along, through, over, upon, under or in the Lot or the Estate.
- (10) Paragraph (e) of Part B of the Second Schedule to the Deed of Mutual Covenant stipulates that:
The right for all the members of the public at all times during 24 hours a day for all lawful purposes freely and without payment of any nature whatsoever to pass and repass on foot or by wheelchair along, to, from, through, over, up and down the Pedestrian Walkway Provided that the Pedestrian Walkway or any part(s) thereof may be closed for maintenance and/or repair for such period subject to the approval in writing by the Director of Lands.
- (7) 公契第80條規定：
商業發展項目的擁有人須根據批地文件特別批地條款第(38)(e)條自費負責保養構成商業發展項目部份的行人走道部份使其保持修葺良好堅固和狀況良好達地政總署署長全面滿意並須根據批地文件特別批地條款第(38)(f)條保持現已或將建造於商業發展項目內該行人走道部份免費開放且不受任何中斷作合法目的，然而行人走道或其任何部份於受制於地政總署署長書面批核下可於該時段關閉作保養及/或維修。
- (8) 公契第88條規定：
商業發展項目的擁有人須根據批地文件特別批地條款第(31)(e)(i)條自費負責維修、保養、更換、翻新、移除及拆卸興建於小型交通運輸交匯處專用範圍內構成商業發展項目的該或該等牆壁及支承結構及符合及履行批地文件特別批地條款第(31)(e)(ii)條。
- (9) 公契附表二之B部份第(c)條規定：
政府、其承租人、租客、持牌人及佔用人（「所有權繼承人」）現獲例外保留小型交通運輸交匯處專用範圍或其任何部份：
- (i) 其權利從該地段，於地政總署署長決定的位置、方式、物料、標準、水平、定線及設計獲得支承與佔用，以便建造及保養於小型交通運輸交匯處專用範圍內現有或將會建造的小型交通運輸交匯處的所有支承結構物及連接物。擁有人須確保該地段內沒有任何結構物或建築物對小型交通運輸交匯處的支承結構物或連接物的建造或保養構成干擾、妨礙或侵害。
 - (ii) 其權利以於需要時從該地段獲得庇護、支承及保護小型交通運輸交匯處專用範圍及其該等部份，而此可從該地段獲庇護、支承及保護權利由地政總署署長決定而其決定為最終決定並對擁有人有約束力。
 - (iii) 其權利進入該地段，不論有否帶同工具、設備、機器、器械或車輛，以便連接、建造、視察、保養、修理及翻新小型交通運輸交匯處及其支承或從屬結構與裝置。
 - (iv) 其權利享有該地段及屋苑的所有必要地役權及通行權，以便往來小型交通運輸交匯處專用範圍及其任何一部份或多部份及其內各支承或從屬結構與裝置，而此權利由地政總署署長決定而其決定為最終決定並對擁有人有約束力。
 - (v) 其權利透過現時或往後鋪設於該地段或屋苑或跟著、穿過、越過跨過或其下該處之任何溝渠、水管、電線、電纜、污水管、排水渠、管槽、排煙道、管道及水道和其他導體而享用接駁至小型交通運輸交匯處專用範圍及其任何部份的氣體、電力、水、污水或其他污水排放、空氣、電話線及其他服務。
- (10) 公契附表二之B部份第(e)條規定：
所有公眾人士有權於每日24小時任何時間內無需任何性質的償付徒步或以輪椅自由由行人走道及跟著、穿過、越過、跨過或其下通過並重新通過行人走道作所有合法目的，然而行人走道或其任何部份於受制於地政總署署長書面批核下可於該時段關閉作保養及/或維修。

(11) Clause 46 of the Third Schedule to the Deed of Mutual Covenant stipulates that:

To observe and comply with Special Condition No.(5)(a)(iii) of the Government Grant with regard to the maintenance of the Green Area and the Green Area Structures and all structures, surfaces, gullies, sewers, drains, fire hydrants, services, street lights, traffic signs, street furniture, road markings and plant constructed, installed and provided thereon or therein in accordance with the Government Grant (until possession of the Green Area is re-delivered to the Government), save and except F.S.I. as Owner of the Government Accommodation shall not be responsible for the maintenance thereof or be required to bear the costs of such maintenance.

(12) Clause 47 of the Third Schedule to the Deed of Mutual Covenant stipulates that:

To observe and comply with Special Condition No.(5)(b)(iii) of the Government Grant with regard to the maintenance of the Green Stippled Black Area and the Green Stippled Black Area Structures and all structures, surfaces, gullies, sewers, drains, fire hydrants, services, street lights, traffic signs, street furniture, road markings and plant constructed, installed and provided thereon or therein in accordance with the Government Grant (until possession of the Green Stippled Black Area is re-delivered to the Government), save and except F.S.I. as Owner of the Government Accommodation shall not be responsible for the maintenance thereof or be required to bear the costs of such maintenance.

(13) Clause 51 of the Third Schedule to the Deed of Mutual Covenant stipulates that:

No Owner shall do or suffer or permit to be done anything whereby the Items may be damaged and each Owner (save and except F.S.I. as Owner of the Government Accommodation) shall be responsible to remedy and indemnify the other Owners in respect of any breach of this Clause including a breach by the occupants of his Unit and their guests, visitors or invitees.

(14) Clause 53 of the Third Schedule to the Deed of Mutual Covenant stipulates that:

To observe and comply with Special Condition Nos.(38)(c) and (38)(e) of the Government Grant with regard to the maintenance of the pedestrian link as Covered Walkway and the Pedestrian Walkway in accordance with the Government Grant, save and except F.S.I. as Owner of the Government Accommodation shall not be responsible for the maintenance thereof or be required to bear the costs of such maintenance.

(15) Clause 54 of the Third Schedule to the Deed of Mutual Covenant stipulates that:

No Owner shall interrupt the use of the Pedestrian Walkway by the public which Pedestrian Walkway shall at all times be kept open for use by the public free of charge without interruption in accordance with Special Condition No.(38)(f) of the Government Grant Provided that the Pedestrian Walkway or any part(s) thereof may be closed for maintenance and/or repair for such period subject to the approval in writing by the Director of Lands.

(16) Clause 66 of the Third Schedule to the Deed of Mutual Covenant stipulates that:

The Owners (save and except F.S.I. as Owner of the Government Accommodation) shall repair, maintain, replace, renew, remove and demolish such part or parts of the walls and supporting structures erected within the Mini Transport Interchange Reserved Area and not forming part of the Commercial Development in accordance with Special Condition No.(31)(e)(i) of the Government Grant and to observe and comply with Special Condition No.(31)(e)(ii) of the Government Grant.

(11) 公契附表三第46條規定：

擁有人須符合及履行批地文件特別批地條款第(5)(a)(iii)條而保養綠色範圍連同綠色範圍構築物及在該處上及內建造、裝設及提供的所有結構物、路面、溝渠、污水管、排水渠、消防栓、服務設施、街燈、交通標誌、街道設施、道路標記及植物（直至綠色範圍之管有交還予政府），然而財政司法團作為政府樓宇的擁有人並不需要負責保養的責任或承擔任何該保養的費用。

(12) 公契附表三第47條規定：

擁有人須符合及履行批地文件特別批地條款第(5)(b)(iii)條而保養綠色加黑點範圍連同綠色加黑點範圍構築物及在該處上及內建造、裝設及提供的所有結構物、路面、溝渠、污水管、排水渠、消防栓、服務設施、街燈、交通標誌、街道設施、道路標記及植物（直至綠色加黑點範圍之管有交還予政府），然而財政司法團作為政府樓宇的擁有人並不需要負責保養的責任或承擔任何該保養的費用。

(13) 公契附表三第51條規定：

任何擁有人不能容許或准許任何可損毀該等物件的行為，及每位擁有人（不包括財政司法團作為政府樓宇的擁有人）須就其包括其實客、訪客或獲邀請人士違反本條款負責補救及彌償其他擁有人。

(14) 公契附表三第53條規定：

擁有人須符合及履行批地文件特別批地條款第(38)(c)條及(38)(e)條而保養連通行人路的有蓋行人路及行人走道，然而財政司法團作為政府樓宇的擁有人並不需要負責保養的責任或承擔任何該保養的費用。

(15) 公契附表三第54條規定：

任何擁有人不能妨礙公眾使用行人走道，而行人走道須根據批地文件特別批地條款第(38)(f)條保持於所有時候開放予公眾人士並且無需收費使用，然而行人走道或其任何部份於受制於地政總署署長書面批核下可於該時段關閉作保養及/或維修。

(16) 公契附表三第66條規定：

擁有人（不包括財政司法團作為政府樓宇的擁有人）須根據批地文件特別批地條款第(31)(e)(i)條維修、保養、更換、翻新、移除及拆卸興建於小型交通運輸交匯處專用範圍內而不構成商業發展項目的該或該等牆壁及支承結構及符合及履行批地文件特別批地條款第(31)(e)(ii)條。

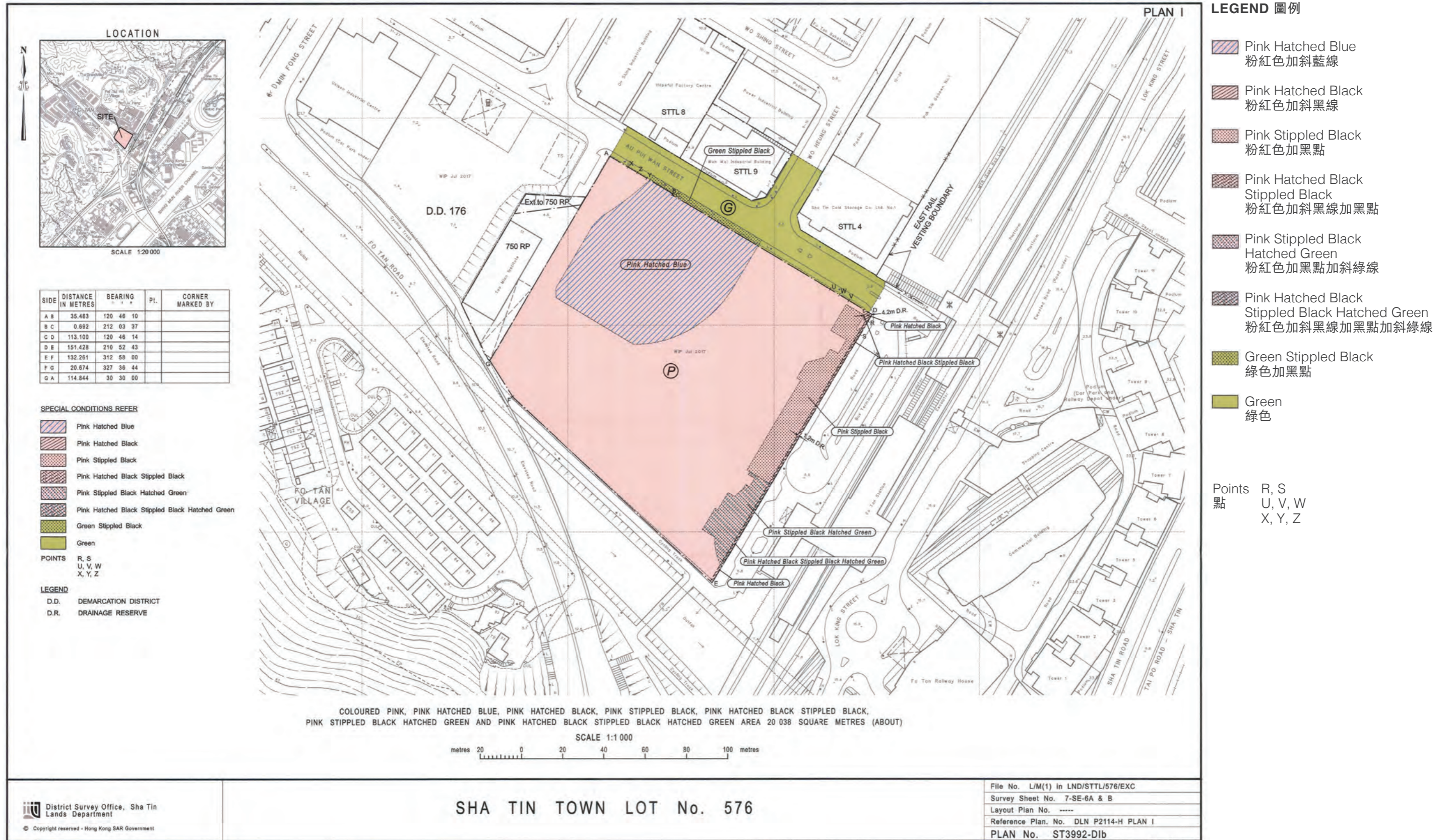

Remarks:
This plan is a reproduction of Plan I as annexed to the Land Grant.

備註：
此圖複製附於批地文件的圖則I。

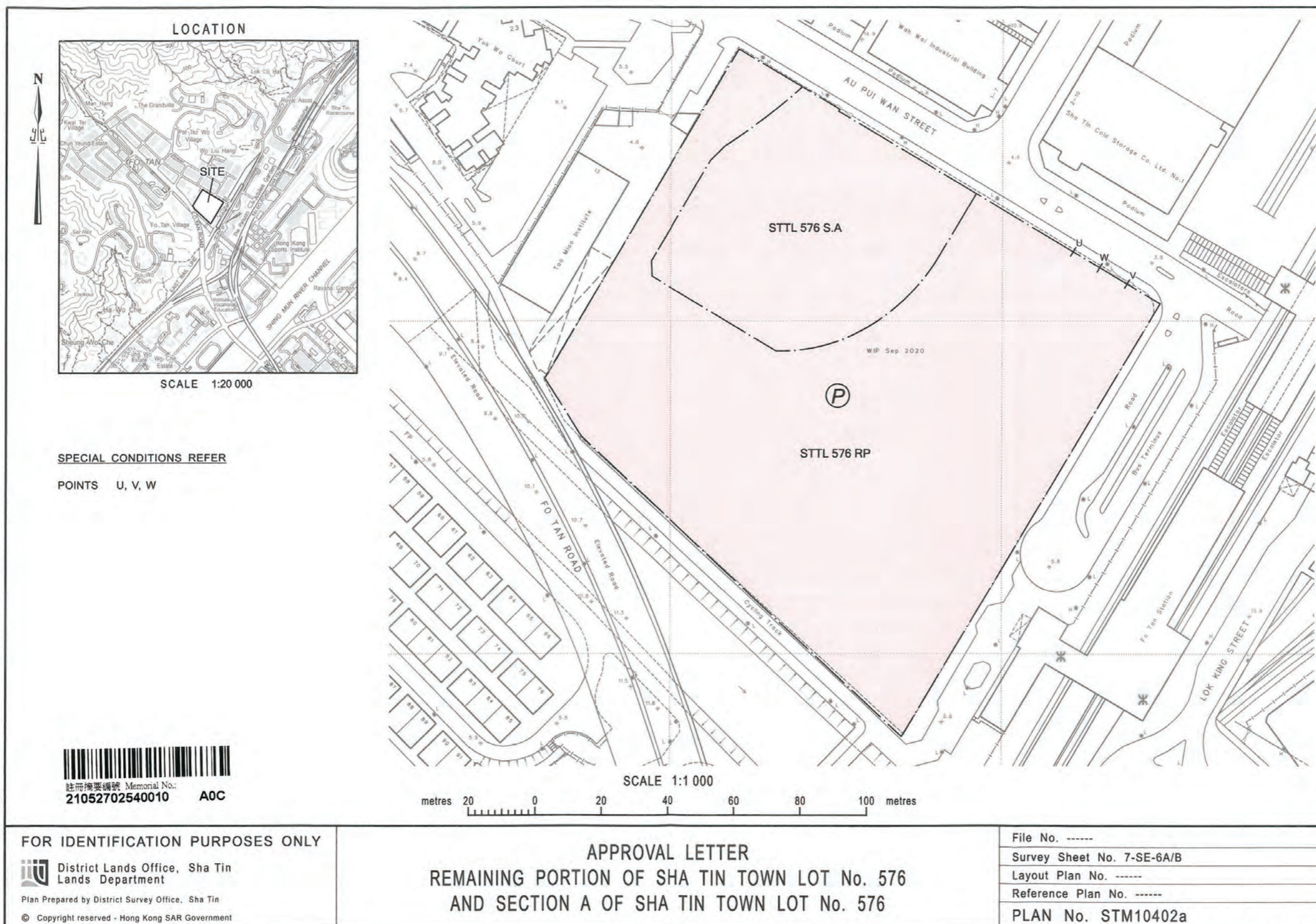

LEGEND 圖例

Points U, V, W
點

Remarks:
This plan is a reproduction of Plan No. STM10402a annexed to the Approval Letter.

備註：
此圖複製附於批准信所夾附圖則號碼STM10402a。



G/F Floor Plan
地下樓面平面圖

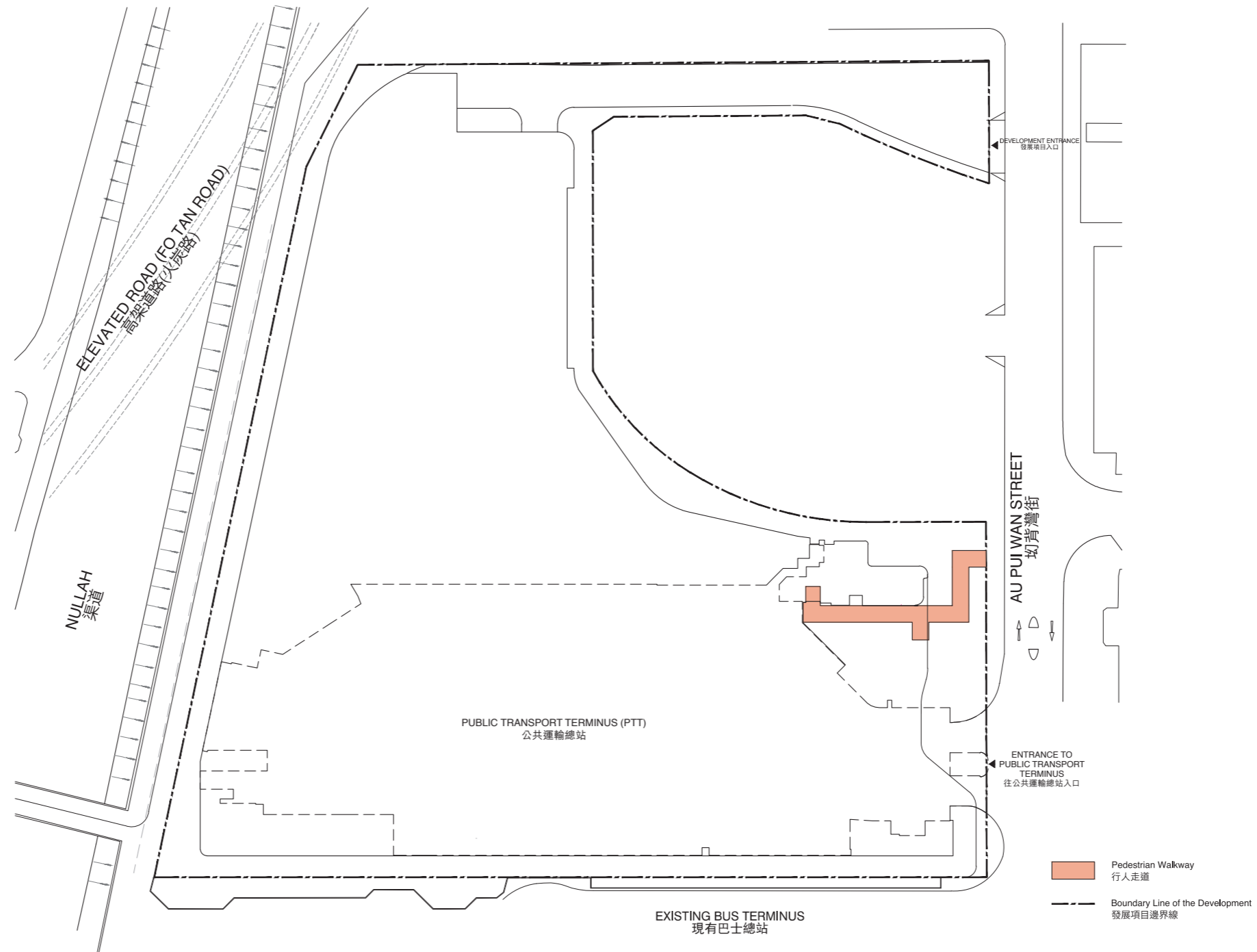

Remarks:

The Pedestrian Walkway may not be available for use immediately upon completion of the Development. Its use and/or operation shall be subject to the issue of consents or approvals by the relevant government authorities, relevant laws, the Land Grant, provisions of the deed of mutual covenants and restrictions of the on-site environment. According to the latest approval building plans, it is estimated that the Pedestrian Walkway shall be completed and open for use upon completion of the commercial portion of the Development.

備註：

行人走道在發展項目落成時未必即時使用，其使用及/或運作可能受制於政府有關部門發出之同意書或許可証、相關法律、批地文件、公契條款及現場環境狀況限制。根據最新的經批准的建築圖則，行人走道預計將會在發展項目的商業部分落成時完成並開放。

Scale 0 25M/米
比例



1/F Floor Plan
1樓樓面平面圖

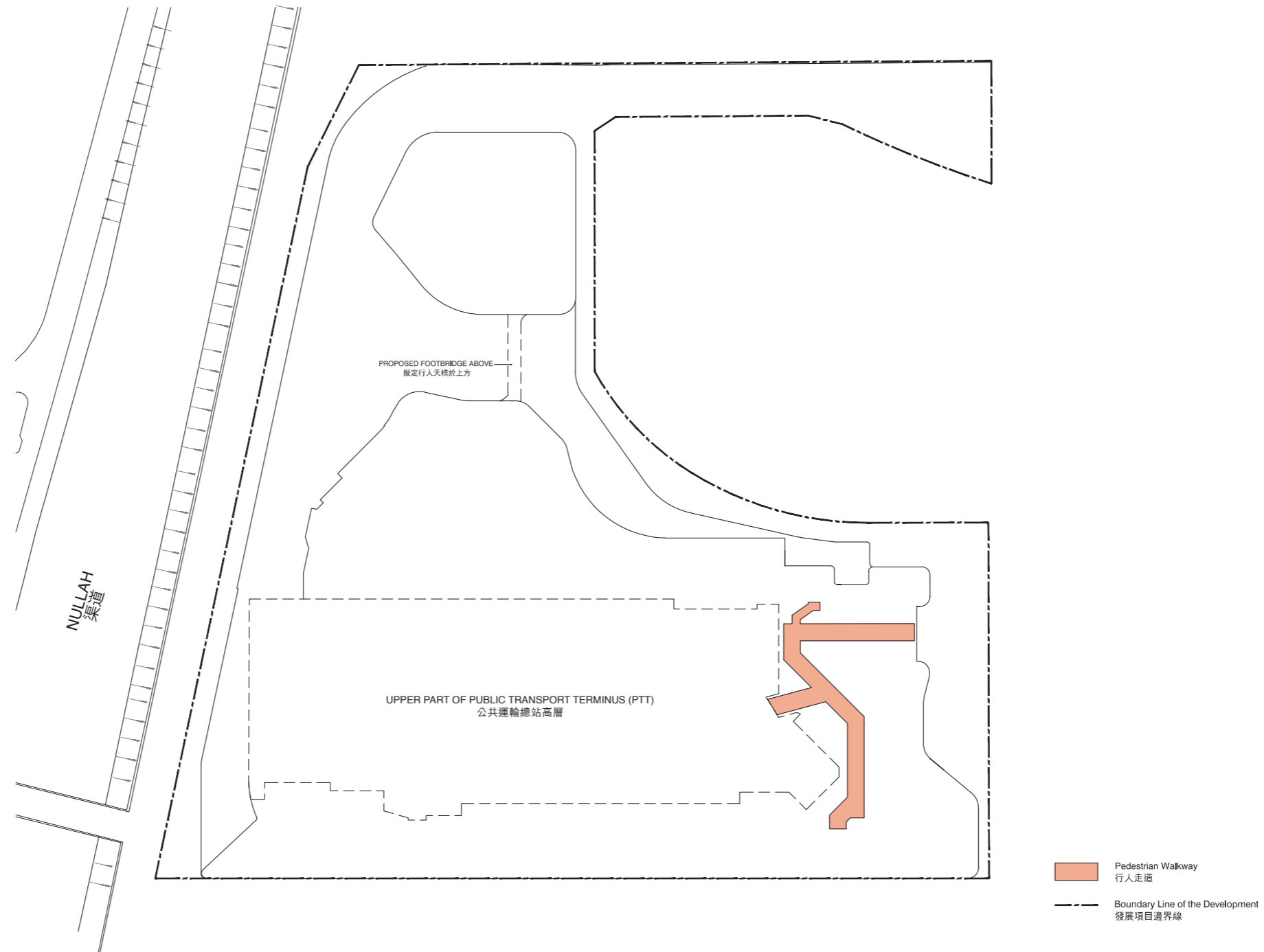

Remarks:

The Pedestrian Walkway may not be available for use immediately upon completion of the Development. Its use and/or operation shall be subject to the issue of consents or approvals by the relevant government authorities, relevant laws, the Land Grant, provisions of the deed of mutual covenants and restrictions of the on-site environment. According to the latest approval building plans, it is estimated that the Pedestrian Walkway shall be completed and open for use upon completion of the commercial portion of the Development.

備註：

行人走道在發展項目落成時未必即時使用，其使用及/或運作可能受制於政府有關部門發出之同意書或許可証、相關法律、批地文件、公契條款及現場環境狀況限制。根據最新的經批准的建築圖則，行人走道預計將會在發展項目的商業部分落成時完成並開放。

Scale 0 25M/米
比例



2/F Floor Plan
2樓樓面平面圖

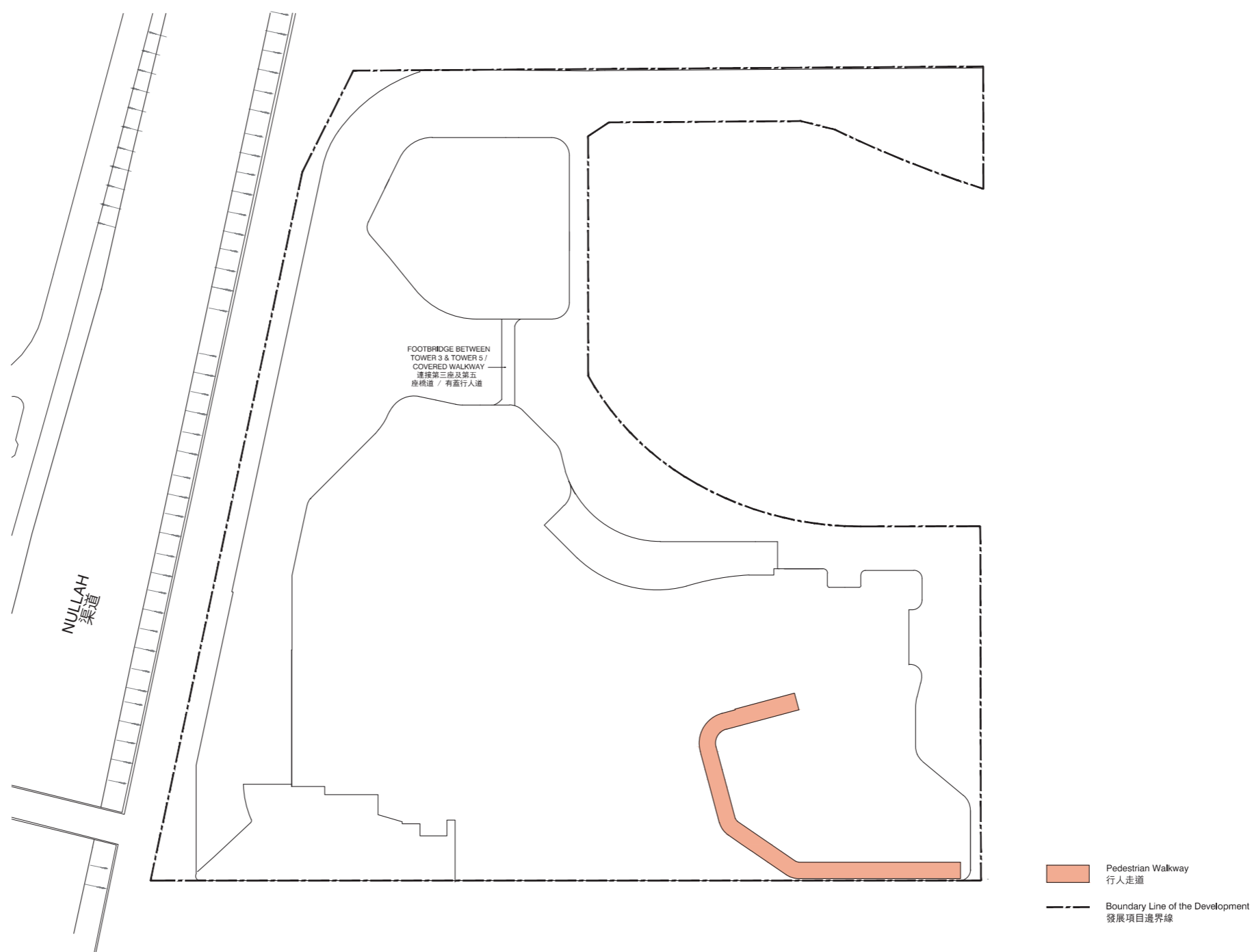

Remarks:

The Pedestrian Walkway may not be available for use immediately upon completion of the Development. Its use and/or operation shall be subject to the issue of consents or approvals by the relevant government authorities, relevant laws, the Land Grant, provisions of the deed of mutual covenants and restrictions of the on-site environment. According to the latest approval building plans, it is estimated that the Pedestrian Walkway shall be completed and open for use upon completion of the commercial portion of the Development.

備註：

行人走道在發展項目落成時未必即時使用，其使用及/或運作可能受制於政府有關部門發出之同意書或許可証、相關法律、批地文件、公契條款及現場環境狀況限制。根據最新的經批准的建築圖則，行人走道預計將會在發展項目的商業部分落成時完成並開放。

Scale 0 25M/米
比例

1. You are recommended to instruct a separate firm of solicitors (other than that acting for the owner) to act for you in relation to the transaction.
2. If you instruct such separate firm of solicitors to act for you in relation to the transaction, that firm will be able to give independent advice to you.
3. If you instruct the firm of solicitors acting for the owner to act for you as well, and a conflict of interest arises between the owner and you:
 - (i) that firm may not be able to protect your interests; and
 - (ii) you may have to instruct a separate firm of solicitors.
4. In the case of paragraph 3.(ii), the total solicitors' fees payable by you may be higher than the fees that would have been payable if you had instructed a separate firm of solicitors in the first place.

1. 此提示建議你聘用一間獨立的律師事務所（代表擁有人行事者除外），以在交易中代表你行事。
2. 如你聘用上述的獨立的律師事務所，以在交易中代表你行事，該律師事務所將會能夠向你提供獨立意見。
3. 如你聘用代表擁有人行事的律師事務所同時代表你行事，而擁有人與你之間出現利益衝突：
 - (i) 該律師事務所可能不能夠保障你的利益；及
 - (ii) 你可能要聘用一間獨立的律師事務所。
4. 如屬 3.(ii) 段的情況，你須支付的律師費用總數，可能高於如你自一開始即聘用一間獨立的律師事務所須支付的費用。

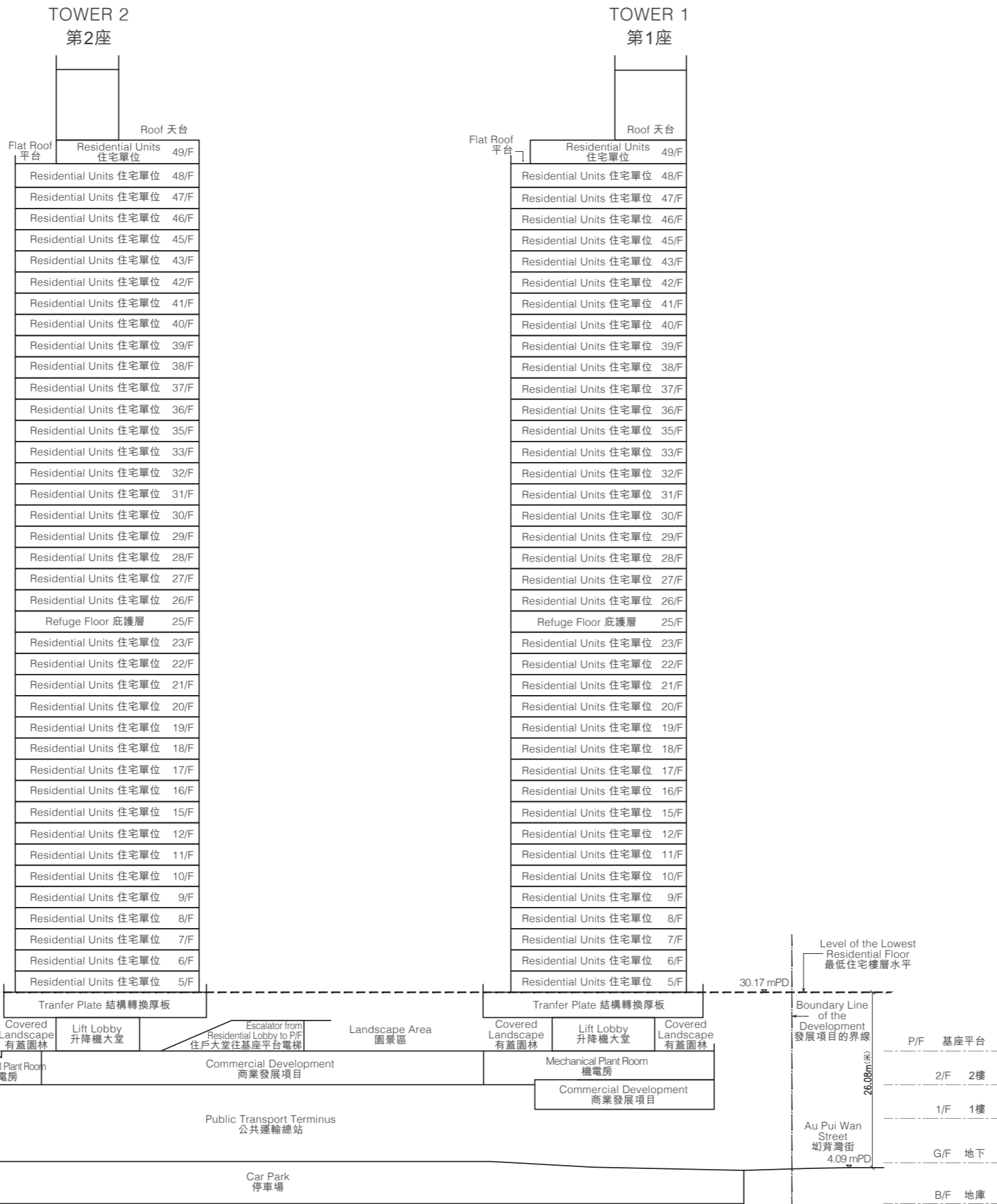

CROSS-SECTION A-A
橫截面圖 A-A

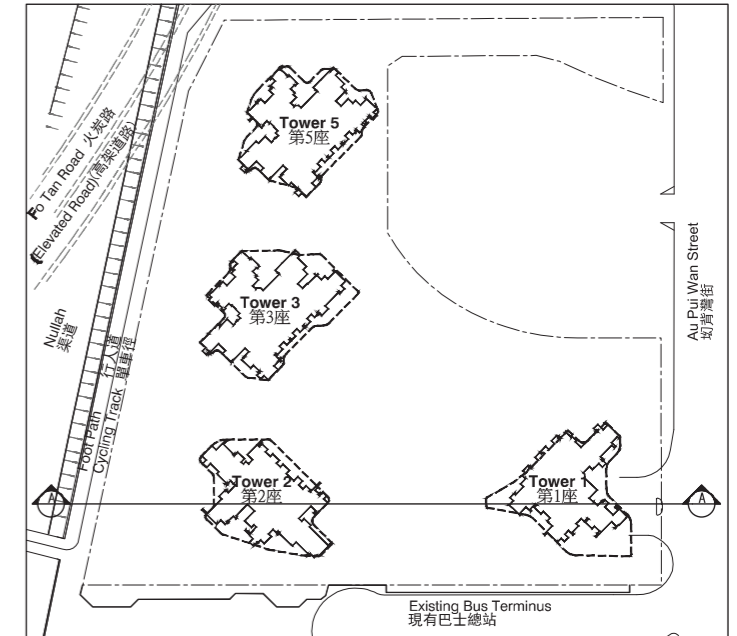

Key Plan
示意圖

Notes 備註:

1. ∇ mPD: Height in metres above Hong Kong Principal Datum (HKPD).
香港主水平基準以上高度 (米)。

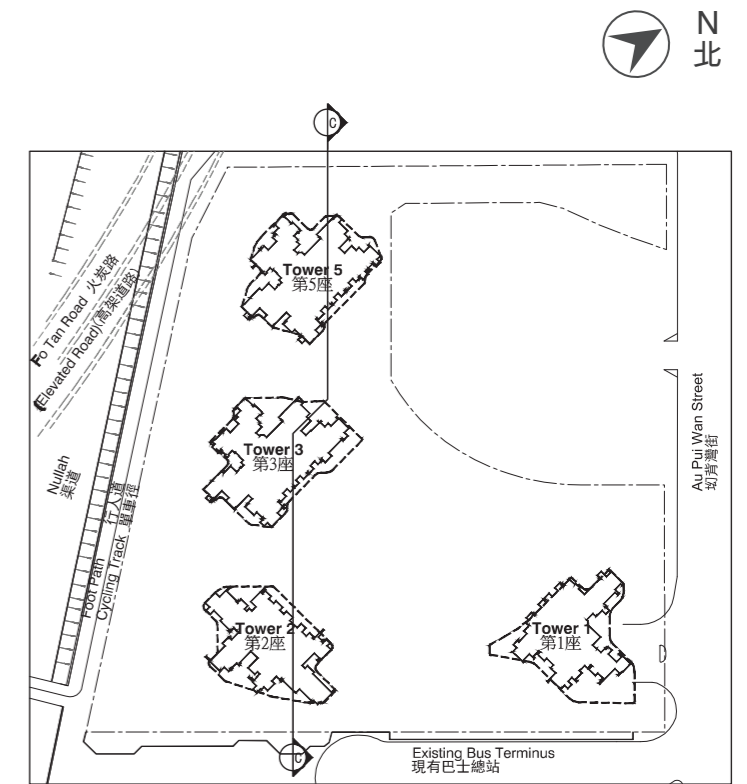
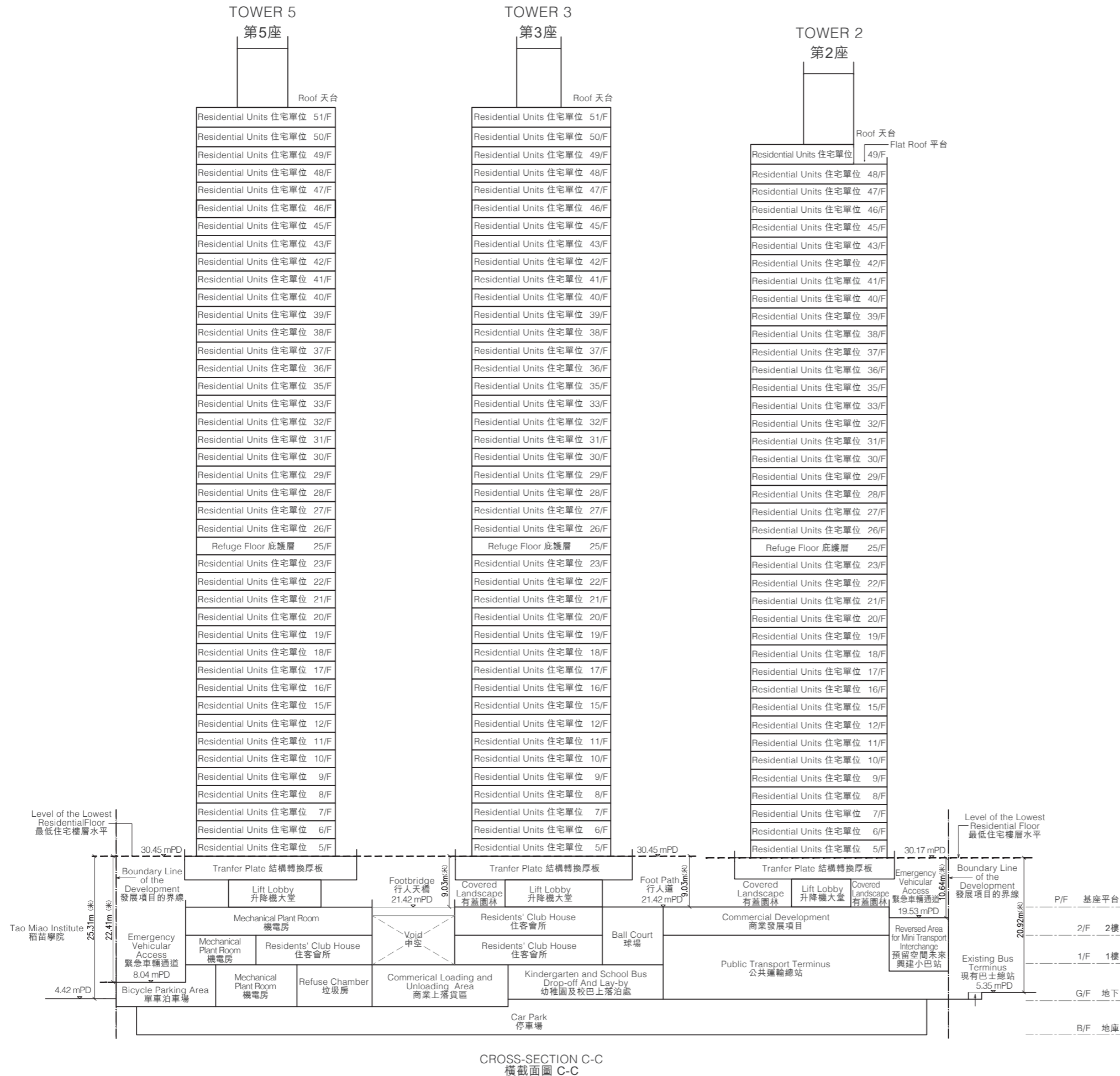

Notes 備註：
 1. ∇ mPD: Height in metres above Hong Kong Principal Datum (HKPD).
 香港主水平基準以上高度（米）。

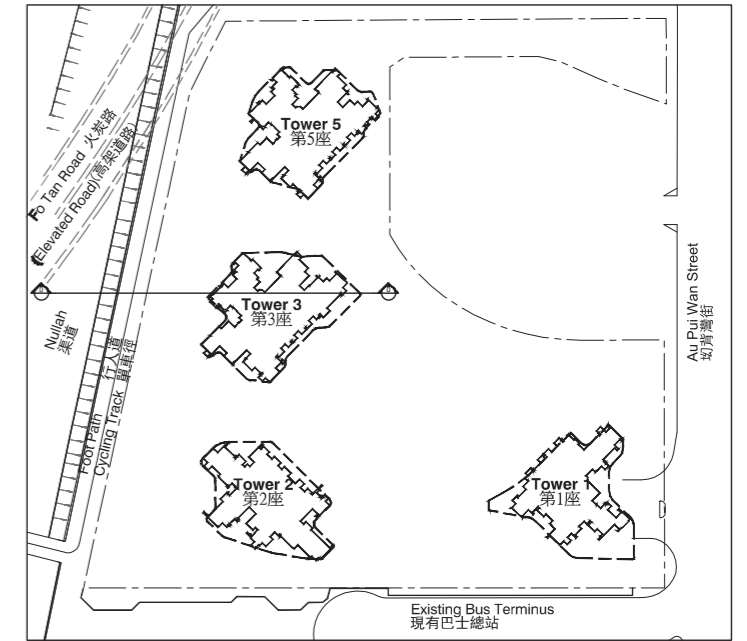
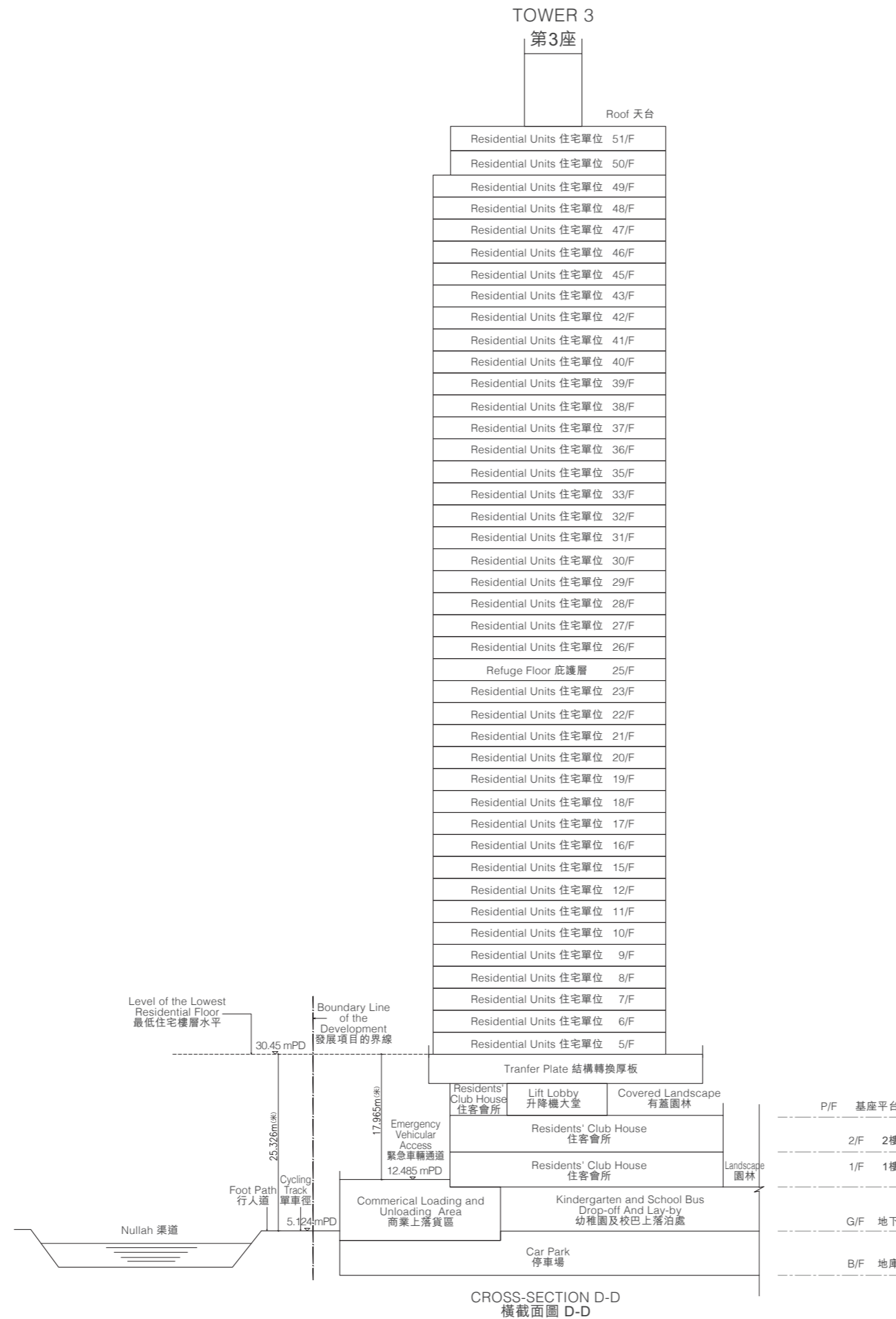

Notes 備註：
 1. ∇ mPD: Height in metres above Hong Kong Principal Datum (HKPD).
 香港主水平基準以上高度（米）。

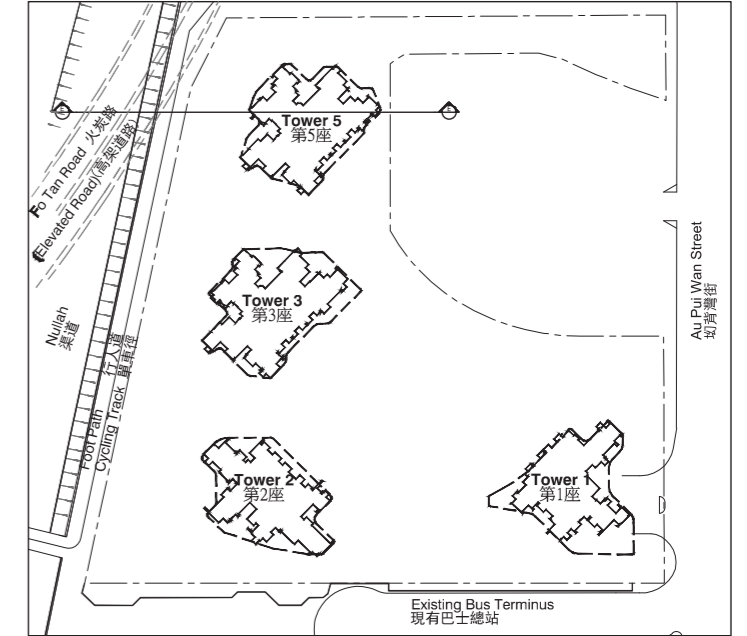
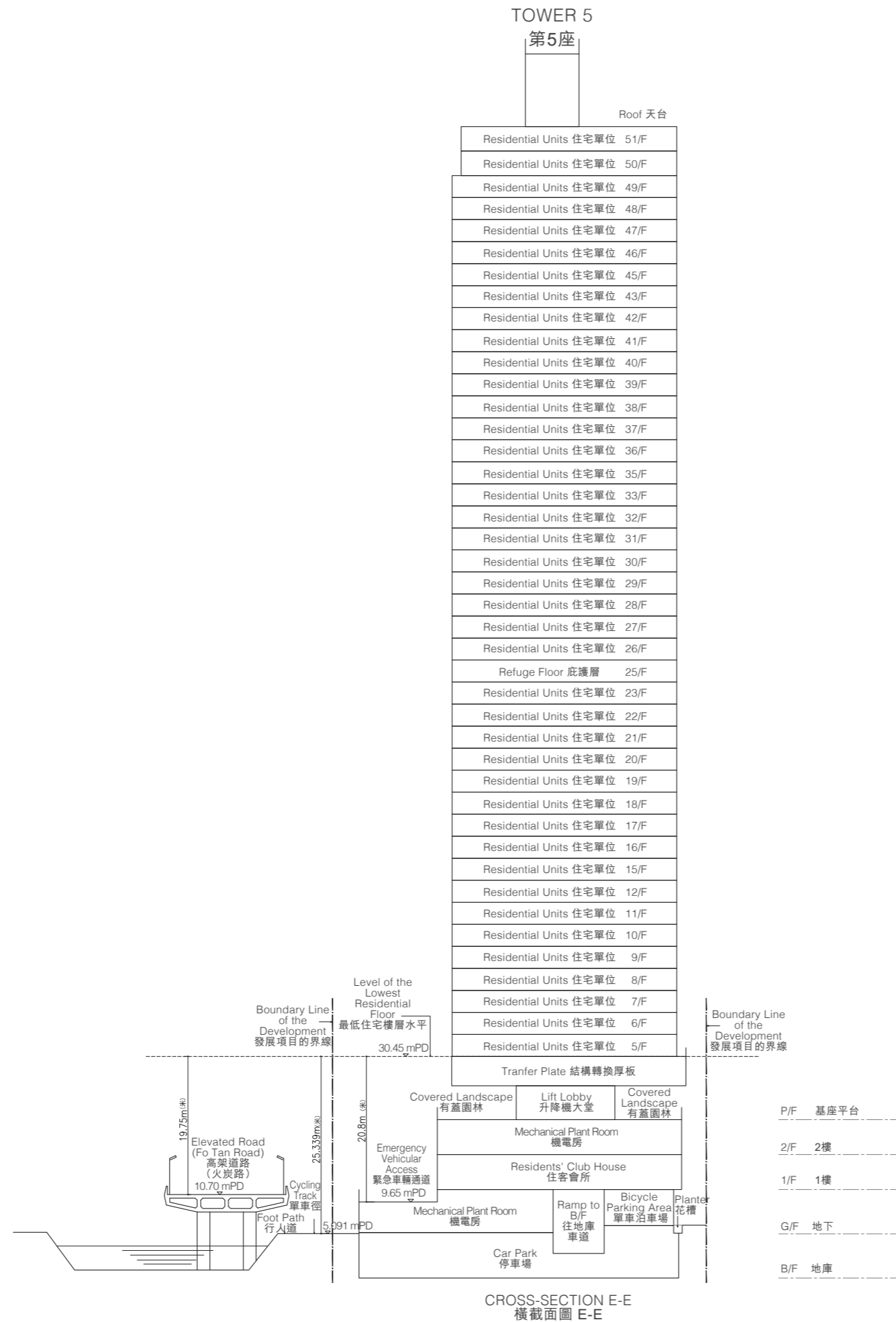

Key Plan
示意圖

Notes 備註：
1. ∇ mPD: Height in metres above Hong Kong Principal Datum (HKPD).
香港主水平基準以上高度（米）。



TOWER 1
第1座

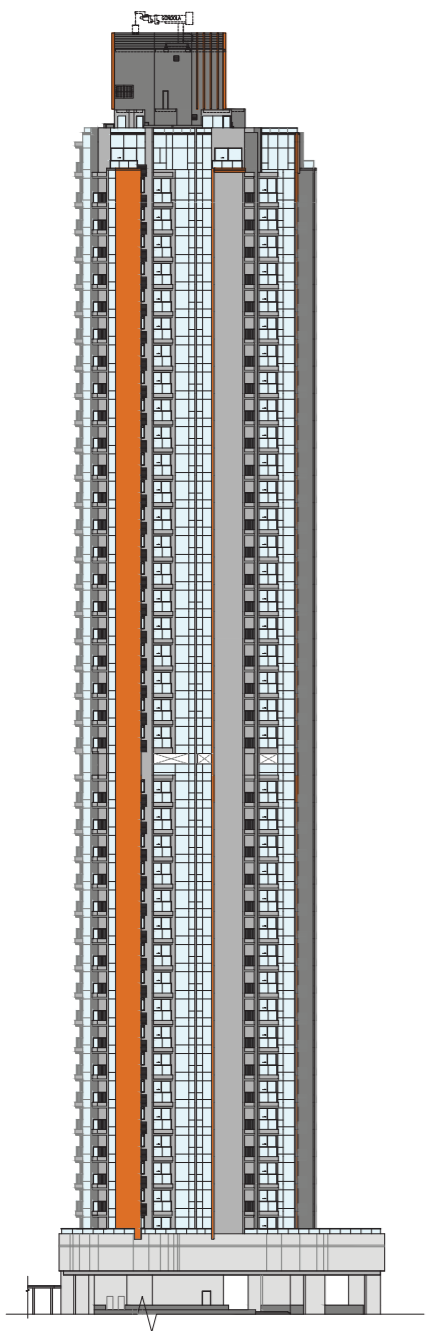

ELEVATION PLAN 1
立面圖 1

TOWER 1
第1座

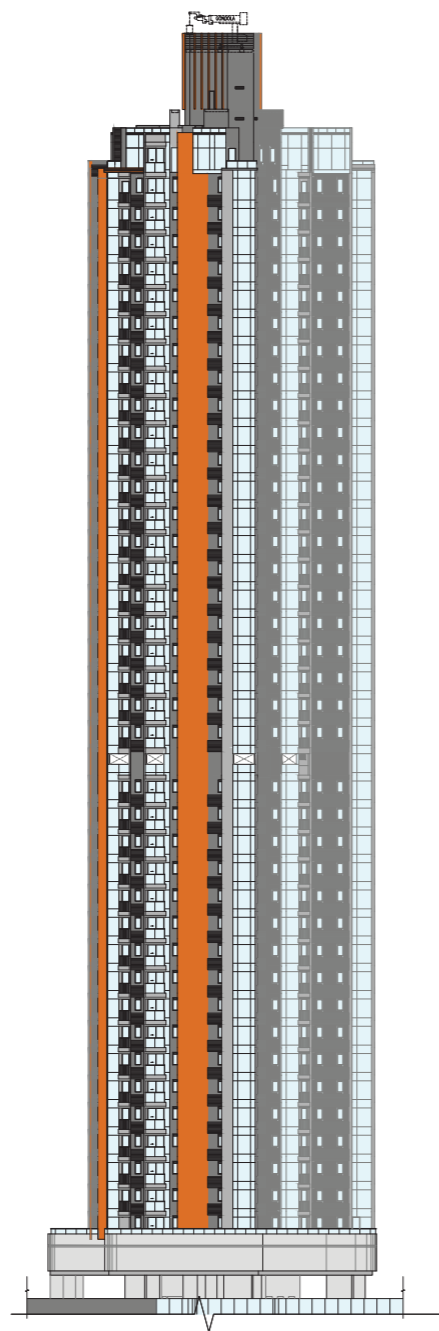

ELEVATION PLAN 2
立面圖 2

TOWER 1
第1座

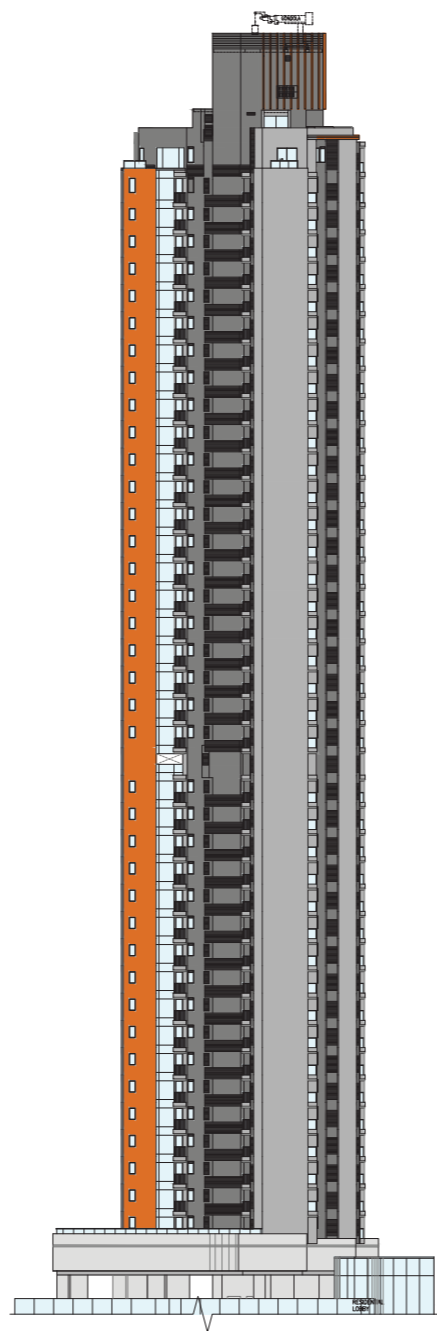

ELEVATION PLAN 3
立面圖 3

TOWER 1
第1座

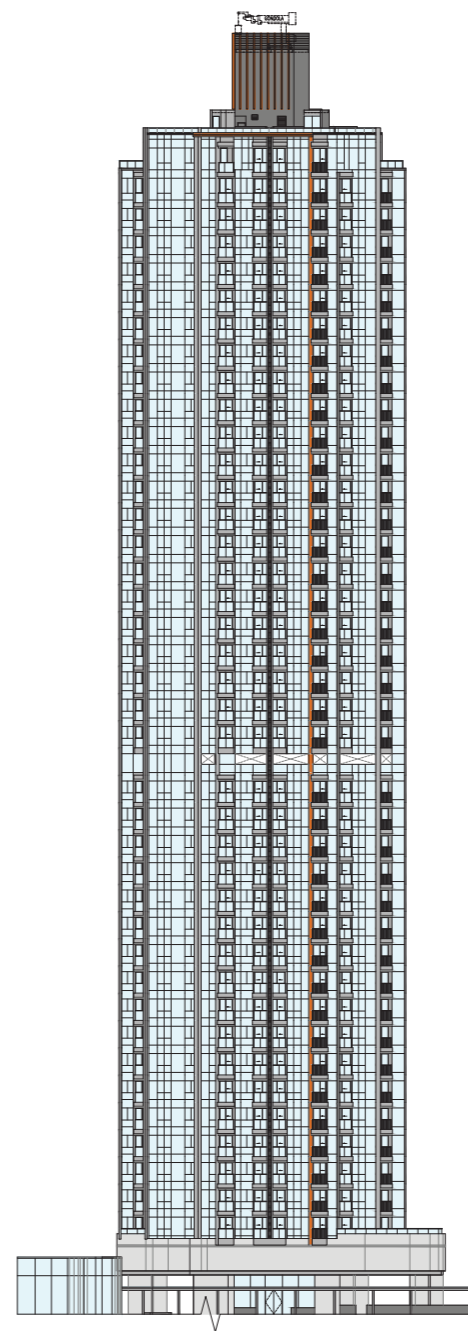

ELEVATION PLAN 4
立面圖 4

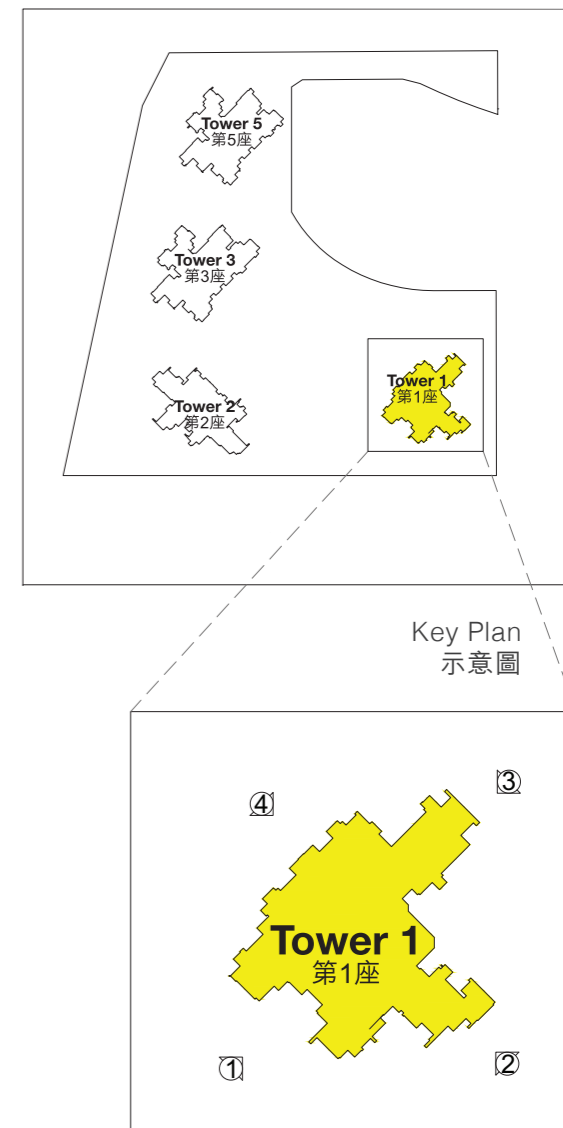

The Authorized Person for the Development has certified that the elevations shown on these plans:
1. are prepared on the basis of the approved building plans for the Development as of 28 August 2020;
2. are in general accordance with the outward appearance of the Development.

發展項目的認可人士已證明本圖所顯示的立面：
1. 以2020年8月28日的情況為準的發展項目經批准的建築圖則為基礎擬備；
2. 大致上與該發展項目的外觀一致。



TOWER 2
第2座

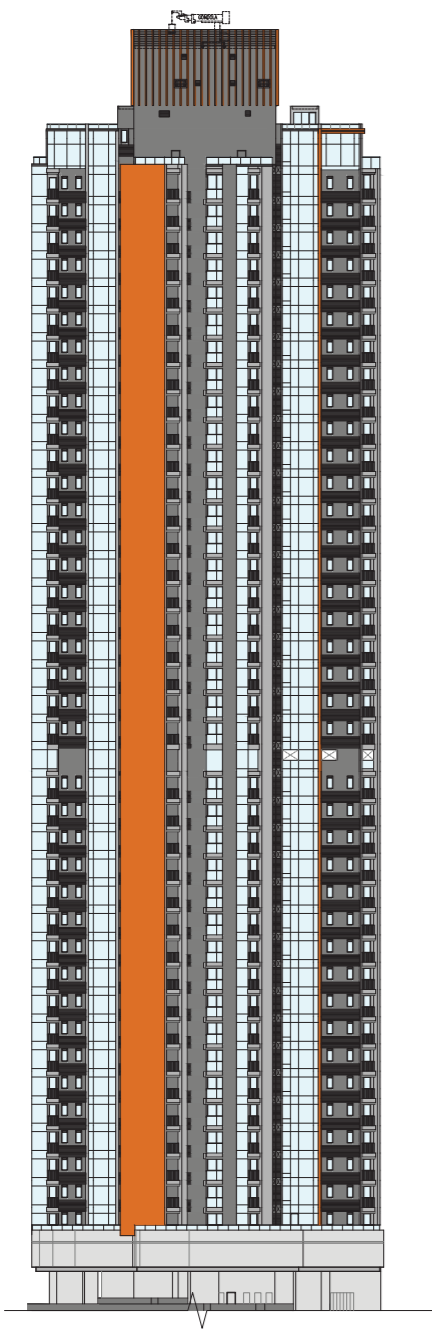

ELEVATION PLAN 1
立面圖 1

TOWER 2
第2座

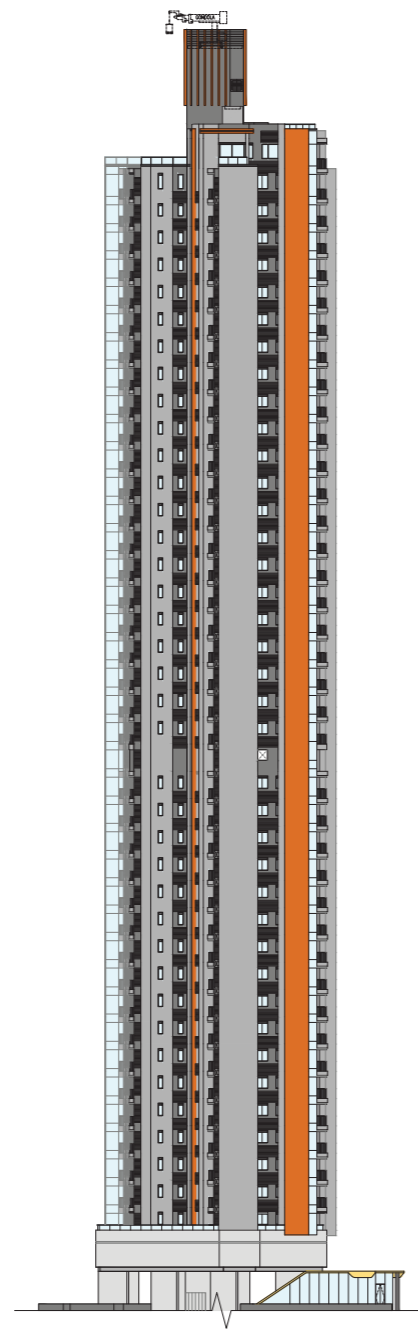

ELEVATION PLAN 2
立面圖 2

TOWER 2
第2座

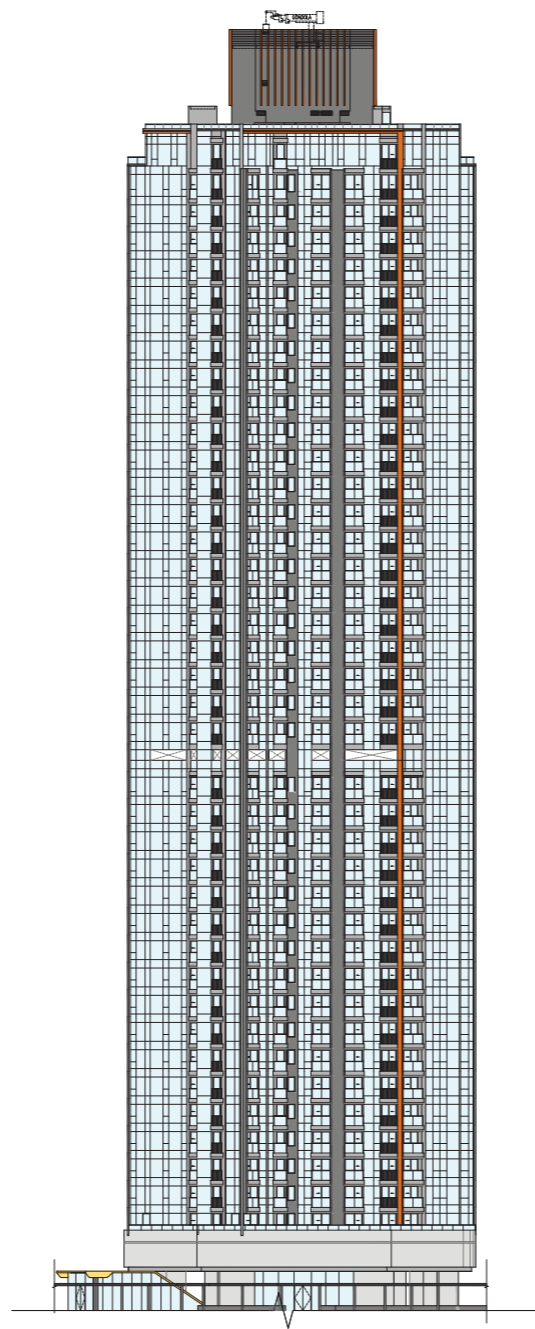

ELEVATION PLAN 3
立面圖 3

TOWER 2
第2座

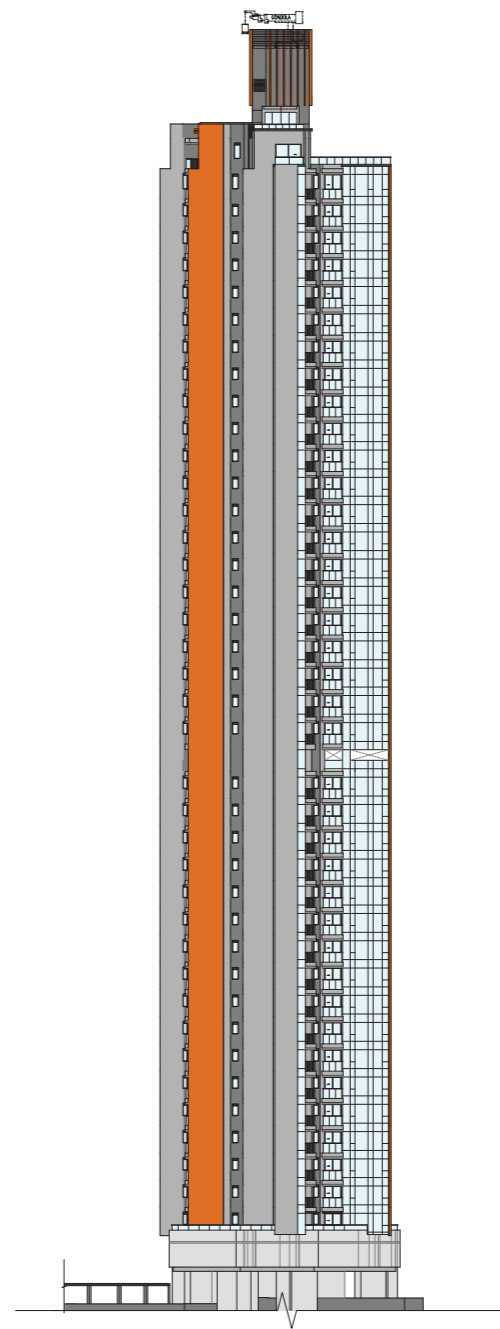

ELEVATION PLAN 4
立面圖 4

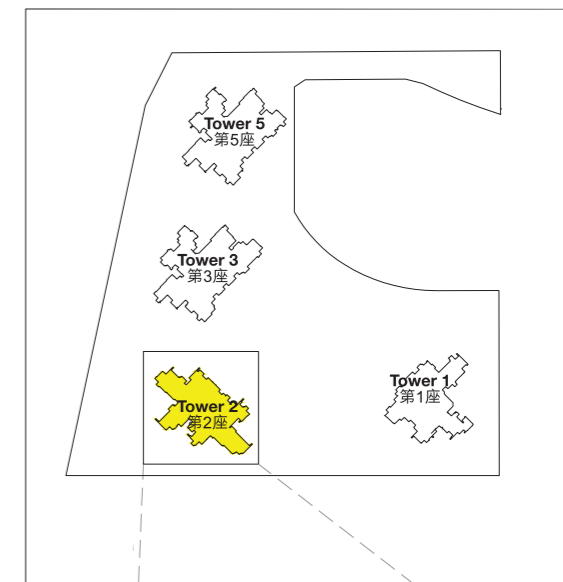

Key Plan
示意圖

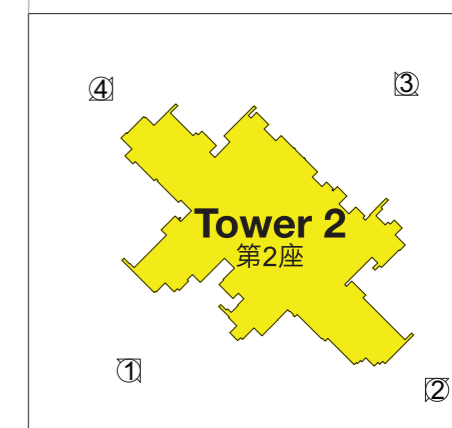

The Authorized Person for the Development has certified that the elevations shown on these plans:
1. are prepared on the basis of the approved building plans for the Development as of 28 August 2020;
2. are in general accordance with the outward appearance of the Development.

發展項目的認可人士已證明本圖所顯示的立面：
1. 以2020年8月28日的情況為準的發展項目經批准的建築圖則為基礎擬備；
2. 大致上與該發展項目的外觀一致。



TOWER 3
第3座

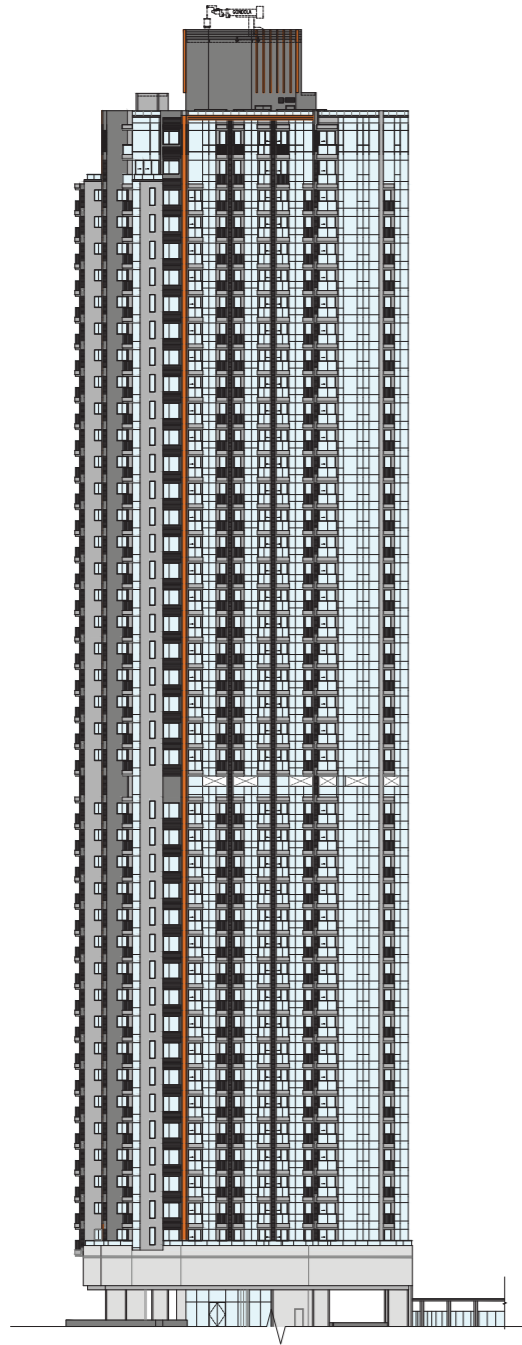

ELEVATION PLAN 1
立面圖 1

TOWER 3
第3座

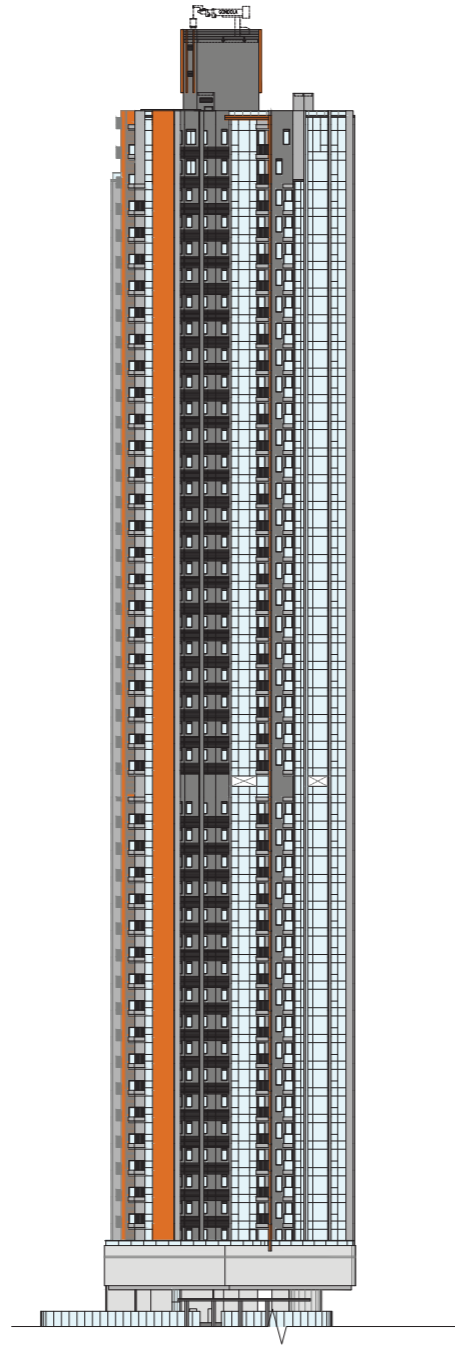

ELEVATION PLAN 2
立面圖 2

TOWER 3
第3座



ELEVATION PLAN 3
立面圖 3

TOWER 3
第3座

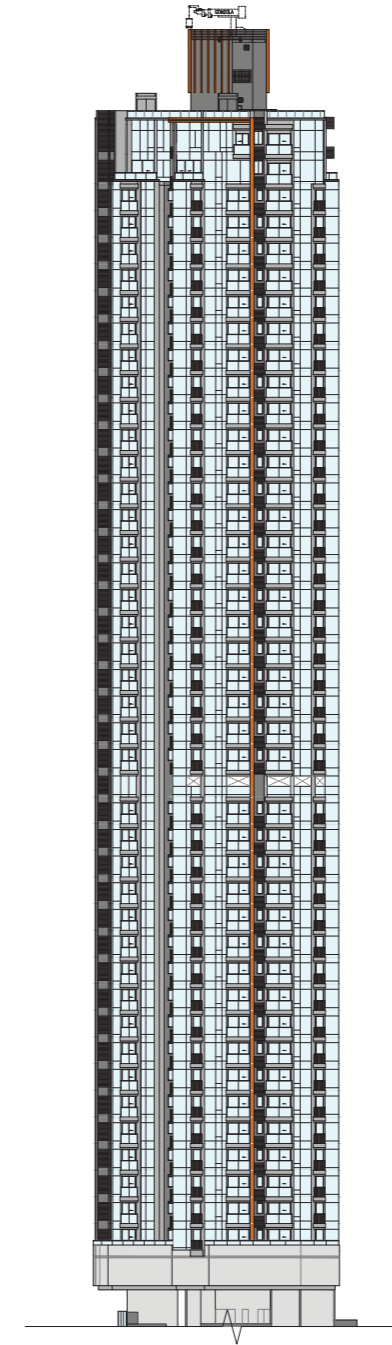

ELEVATION PLAN 4
立面圖 4

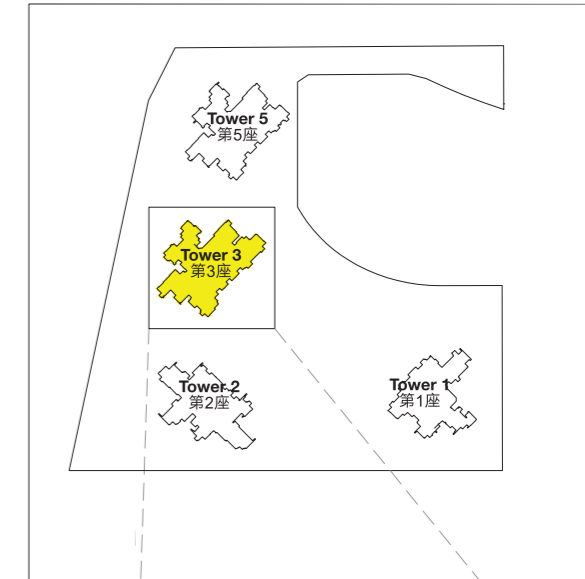

Key Plan
示意圖

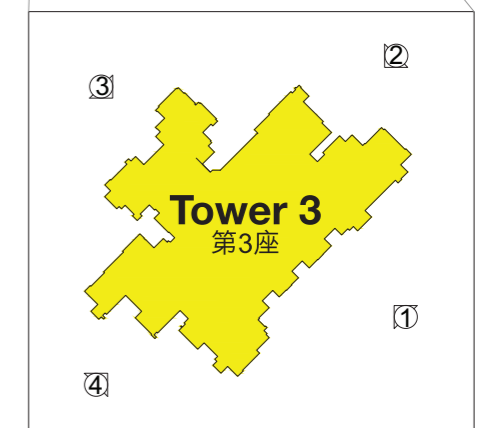

The Authorized Person for the Development has certified that the elevations shown on these plans:
1. are prepared on the basis of the approved building plans for the Development as of 28 August 2020;
2. are in general accordance with the outward appearance of the Development.

發展項目的認可人士已證明本圖所顯示的立面：
1. 以2020年8月28日的情況為準的發展項目經批准的建築圖則為基礎擬備；
2. 大致上與該發展項目的外觀一致。



TOWER 5
第5座

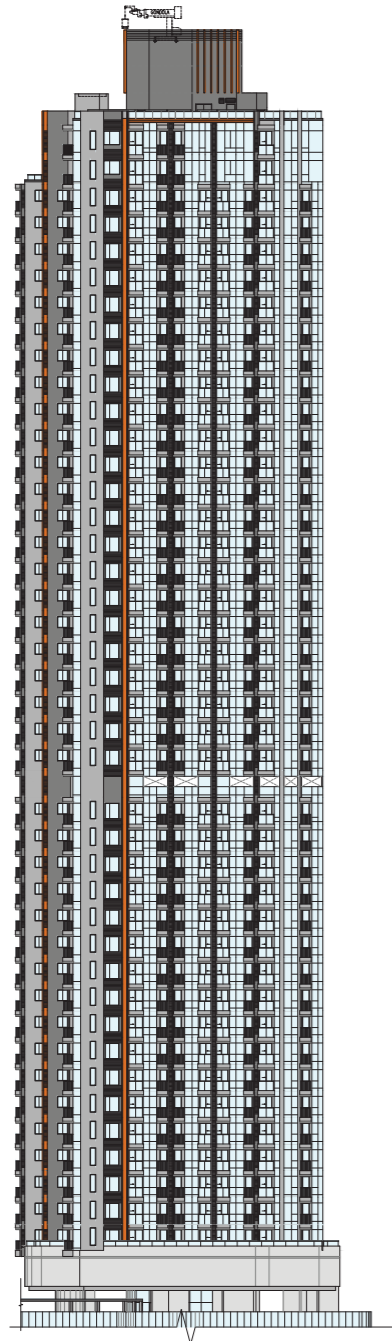

ELEVATION PLAN 1
立面圖 1

TOWER 5
第5座

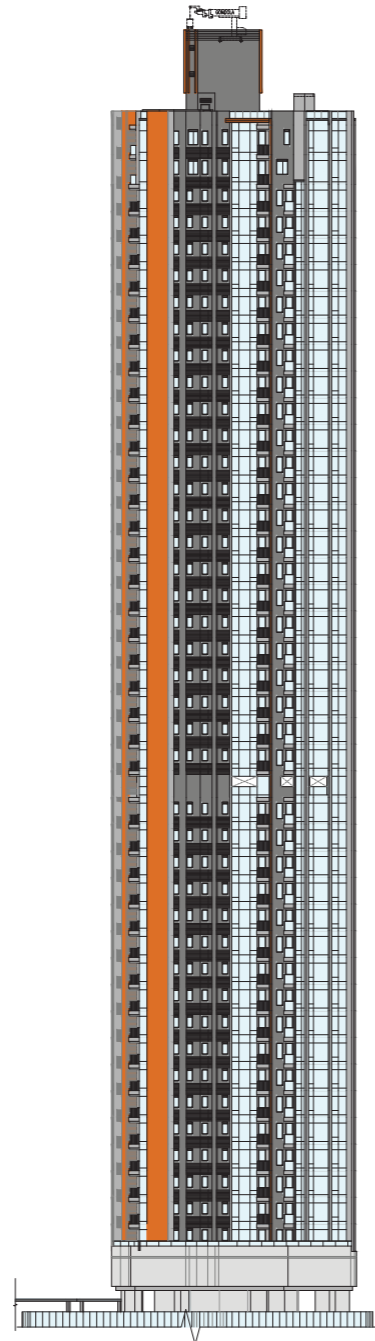

ELEVATION PLAN 2
立面圖 2

TOWER 5
第5座

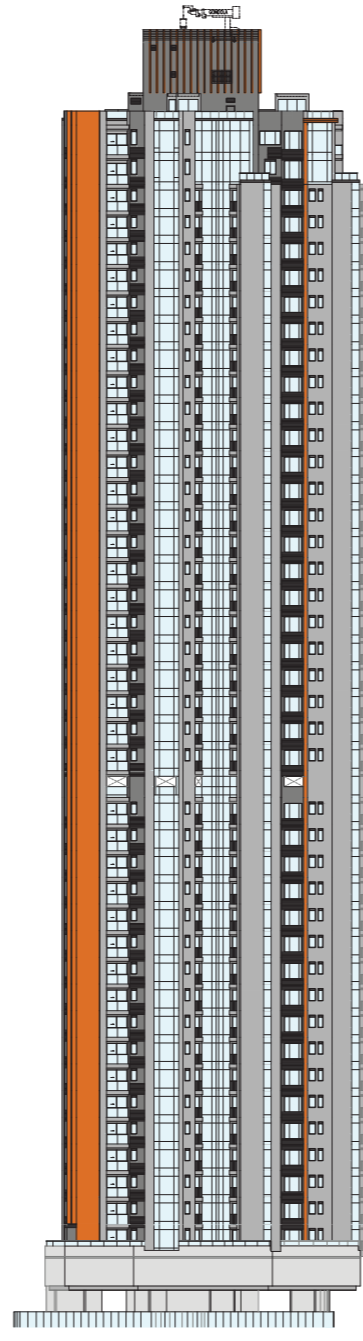

ELEVATION PLAN 3
立面圖 3

TOWER 5
第5座



ELEVATION PLAN 4
立面圖 4

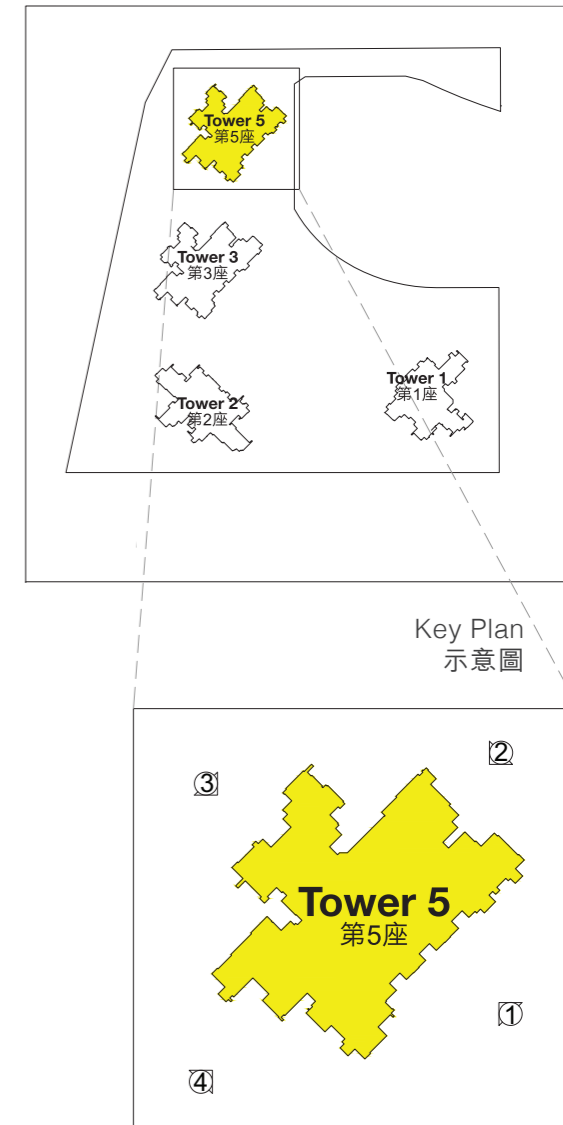

The Authorized Person for the Development has certified that the elevations shown on these plans:
1. are prepared on the basis of the approved building plans for the Development as of 28 August 2020;
2. are in general accordance with the outward appearance of the Development.

發展項目的認可人士已證明本圖所顯示的立面：
1. 以2020年8月28日的情況為準的發展項目經批准的建築圖則為基礎擬備；
2. 大致上與該發展項目的外觀一致。

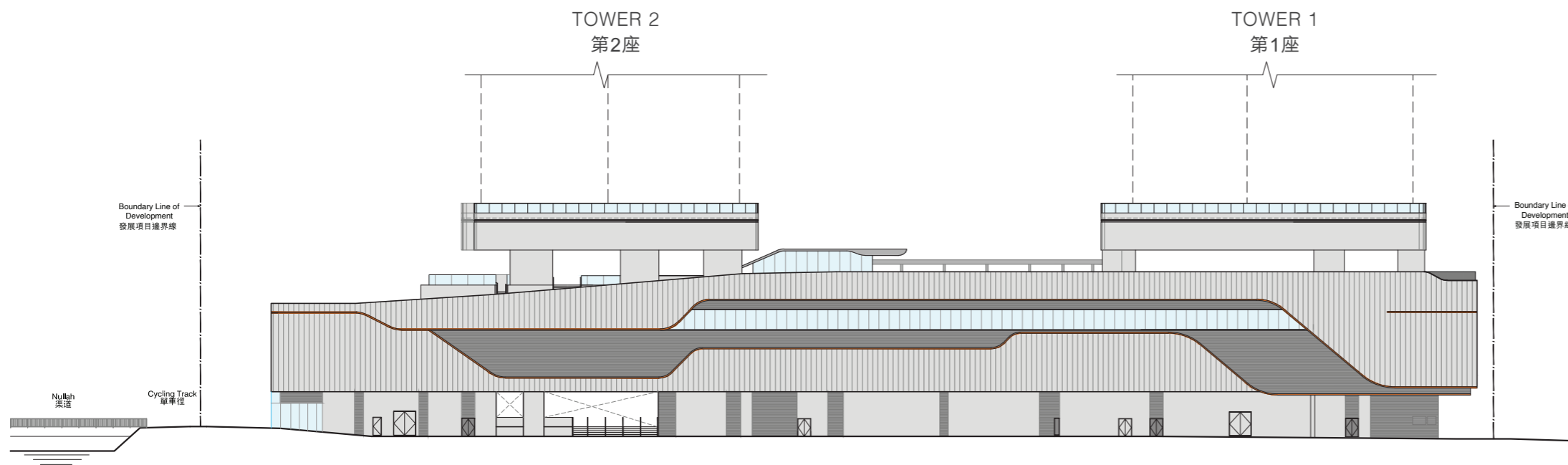

ELEVATION PLAN 1
立面圖 1

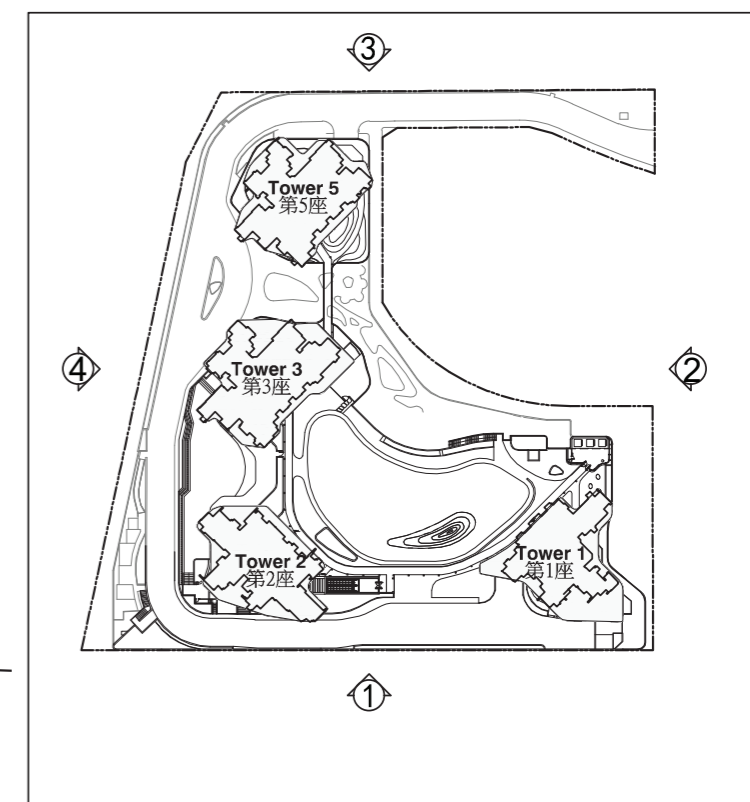

Key Plan
示意圖

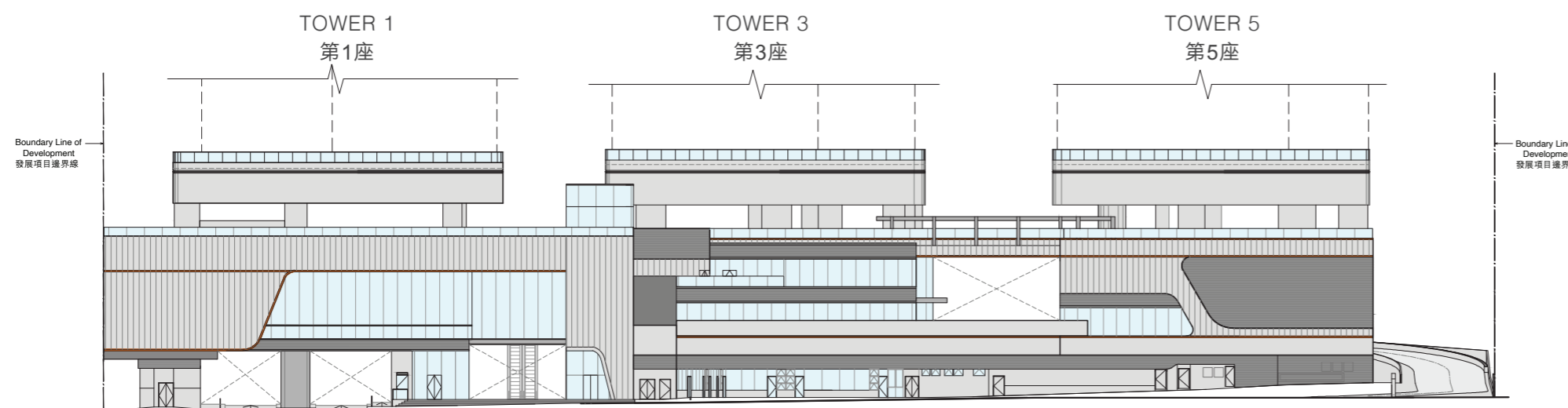

ELEVATION PLAN 2
立面圖 2

The Authorized Person for the Development has certified that the elevations shown on these plans:
1. are prepared on the basis of the approved building plans for the Development as of 28 August 2020; and
2. are in general accordance with the outward appearance of the Development.

發展項目的認可人士已證明本圖所顯示的立面：
1. 以2020年8月28日的情況為準的發展項目經批准的建築圖則為基礎擬備；及
2. 大致上與該發展項目的外觀一致。

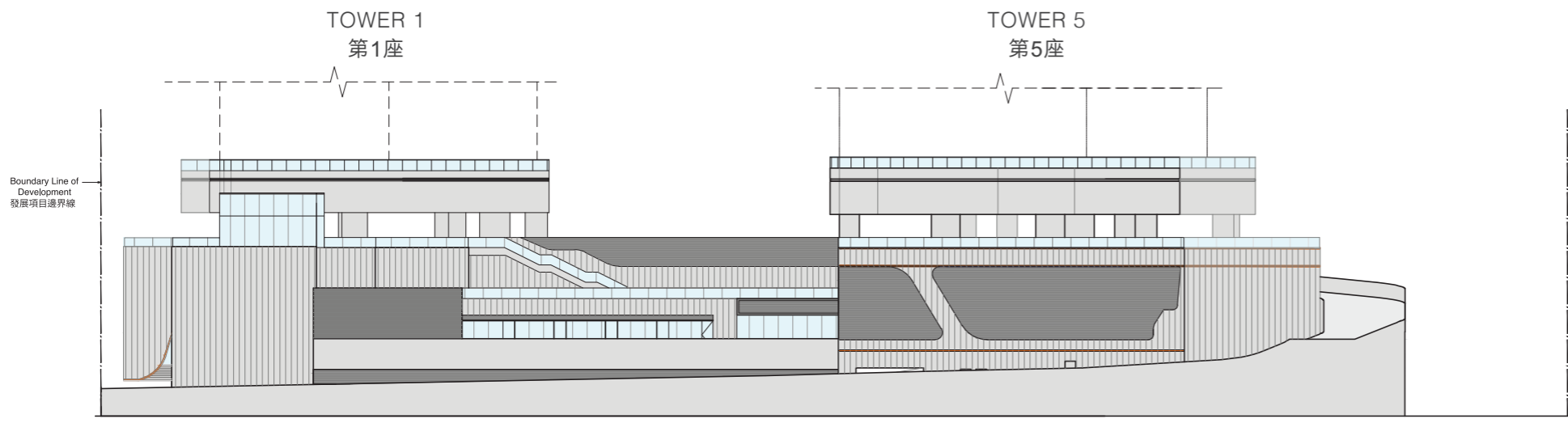

ELEVATION PLAN 3
立面圖 3

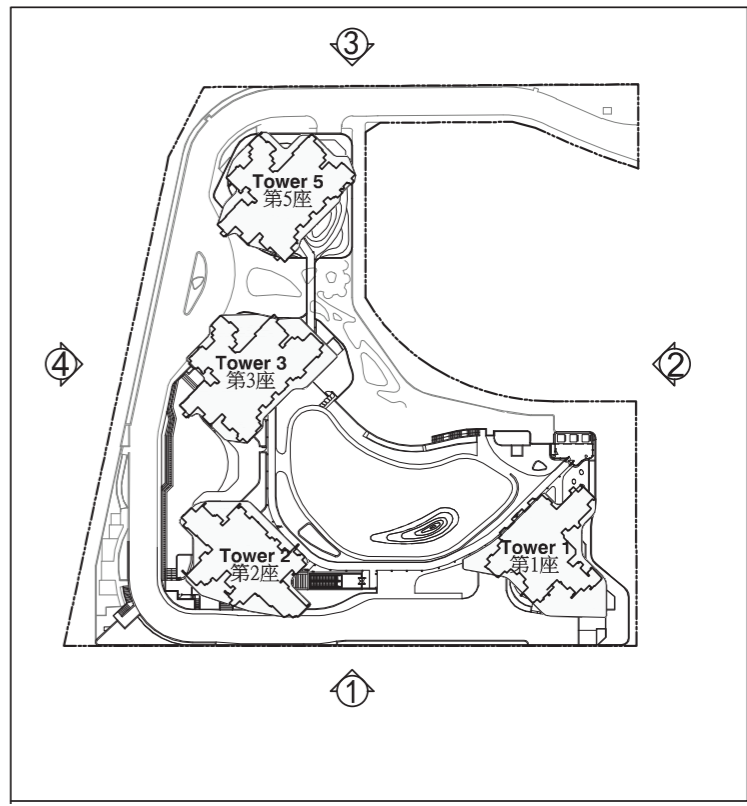

Key Plan
示意圖

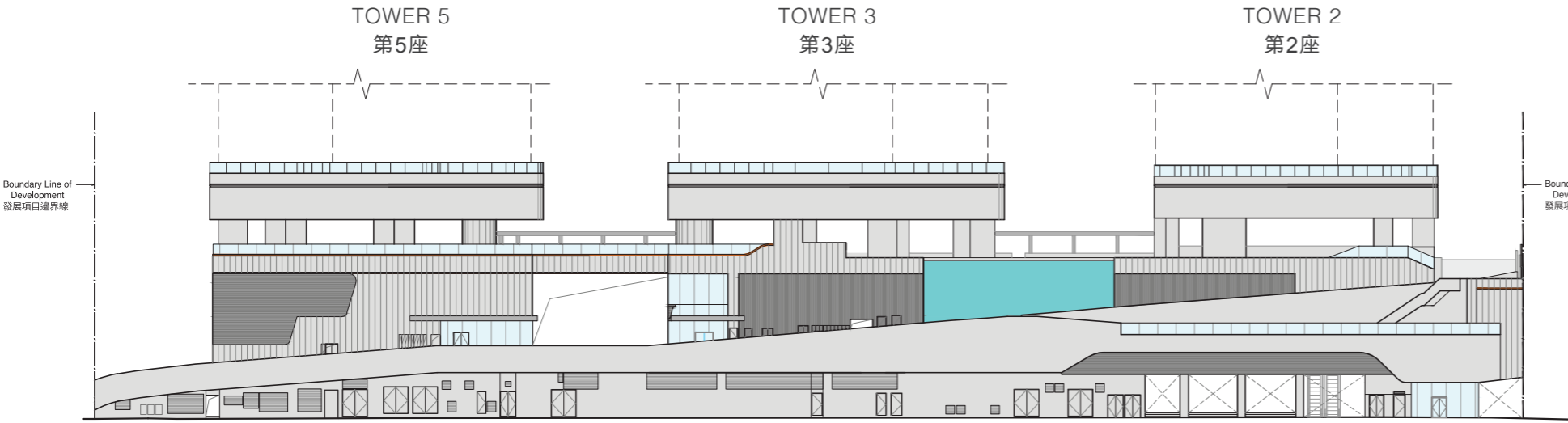

ELEVATION PLAN 4
立面圖 4

The Authorized Person for the Development has certified that the elevations shown on these plans:
1. are prepared on the basis of the approved building plans for the Development as of 28 August 2020; and
2. are in general accordance with the outward appearance of the Development.

發展項目的認可人士已證明本圖所顯示的立面：
1. 以2020年8月28日的情況為準的發展項目經批准的建築圖則為基礎擬備；及
2. 大致上與該發展項目的外觀一致。

Common Facilities 公用設施		Area 面積		Total Area 總面積	
		sq. m. 平方米	sq. ft. 平方呎	sq. m. 平方米	sq. ft. 平方呎
Residents' clubhouse (including any recreational facilities for residents' use) 住客會所 (包括供住客使用的任何康樂設施)	Covered 有上蓋	2,838.647	30,555	4,209.369	45,309
	Uncovered 沒有上蓋	1,370.722	14,754		
Communal garden or play area for residents' use on the roof, or on any floor between the roof and the lowest residential floor, of a building in the Development (whether known as a communal sky garden or otherwise) 位於發展項目中的建築物的天台或在天台和最低一層住宅樓層之間的任何一層的、供住客使用的公用花園或遊樂地方 (不論是稱為公用空中花園或有其他名稱)	Covered 有上蓋	N/A 不適用	N/A 不適用	N/A 不適用	N/A 不適用
	Uncovered 沒有上蓋				
Communal garden or play area for residents' use below the lowest residential floor, of a building in the Development (whether known as a covered and landscaped play area or otherwise) 位於發展項目中的建築物的最低一層住宅樓層以下的、供住客使用的公用花園或遊樂地方 (不論是稱為有蓋及園景的遊樂場或有其他名稱)	Covered 有上蓋	2,401.456	25,849	6,780.982	72,990
	Uncovered 沒有上蓋	4,379.526	47,141		

Remarks :

Areas in square feet are converted from areas in square metres at a rate of 1 square metre to 10.764 square feet and rounded off to the nearest integer.

備註：

以平方呎顯示之面積由以平方米顯示之面積以1平方米=10.764平方呎換算，並四捨五入至整數。

1. Copies of the Outline Zoning Plans relating to the Development is available at: <http://www.ozp.tpb.gov.hk>
2. (a) The latest draft of every deed of mutual covenant in respect of the specified residential property as at the date on which the specified residential property is offered to be sold is available for inspection at the place at which the specified residential property is offered to be sold.
(b) The inspection is free of charge.

1. 備有關於本發展項目的分區計劃大綱圖的文本供閱覽的互聯網網站的網址為：<http://www.ozp.tpb.gov.hk>
2. (a) 指明住宅物業的每一公契在將指明住宅物業提供出售的日期的最新擬稿的文本存放在指明住宅物業的售樓處，以供閱覽。
(b) 無須為閱覽付費。

1. EXTERIOR FINISHES

Item		Description				
(a)	External wall	Type of finishes	Podium	Glass panel, stone cladding, tiles, aluminium cladding, aluminium louver, glass cladding and spray paint		
			Residential Tower	Tiles, curtain wall, aluminium cladding, glass balustrade and aluminium louver		
(b)	Window	Curtain Wall	Material of the frame and glass		Aluminium window frame with Insulated Glass Unit (IGU) of tinted low-e coating glass for the following residential units	
			Tower		Unit	Location
			Tower 1	5/F - 12/F, 15/F - 23/F, 26/F - 33/F, 35/F - 43/F & 45/F - 48/F	A	Living room, Dining room, Master bedroom, Bedroom 1 and Bedroom 2
					B & F	Living room and Master bedroom
					C	Living room
					D, E, G & H	Living room, Master bedroom and Bedroom 1
					A	Living room, Dining room, Kitchen, Master bedroom, Bedroom 2 and Bedroom 3
						49/F
			C	Living room, Kitchen, Master bedroom, Bedroom 1 and Bedroom 2		
			Tower 2	5/F - 12/F, 15/F - 23/F, 26/F - 33/F, 35/F - 43/F & 45/F - 48/F	A	
					B	Bedroom 1
					C	Living room, Dining room, Master bedroom, Bedroom 1 and Bedroom 2
D & G	Living room, Master bedroom and Bedroom 1					
E & H	Living room					
F	Living room, Kitchen, Master bedroom, Bedroom 1 and Bedroom 2					
49/F	A	Living room, Dining room, Kitchen, Master bedroom, Bedroom 1, Bedroom 2 and Bedroom 3				
	B	Living Room, Dining room, Kitchen, Master bedroom, Bedroom 1 and Bedroom 3				

1. 外部裝修物料

細項		描述					
(a)	外牆	裝修物料的类型	基座平台	玻璃面板、石材飾板、瓷磚、鋁飾板、鋁百葉、玻璃飾板及噴漆			
			住宅大樓	瓷磚、幕牆、鋁飾板、玻璃圍欄及鋁百葉			
(b)	窗	幕牆	框及玻璃的用料		裝設幕牆鋁框配有低輻射鍍膜中空玻璃 (IGU) 於以下住宅單位		
			座數		單位	位置	
			第1座	5樓-12樓、15樓-23樓、26樓-33樓、35樓-43樓及45樓-48樓	A	客廳、飯廳、主人睡房、睡房1及睡房2	
					B及F	客廳及主人睡房	
					C	客廳	
					D、E、G及H	客廳、主人睡房及睡房1	
					49樓	A	客廳、飯廳、廚房、主人睡房、睡房2及睡房3
						B	客廳、廚房、主人睡房、睡房1、睡房2及睡房3
			第2座	5樓-12樓、15樓-23樓、26樓-33樓、35樓-43樓及45樓-48樓	C	客廳、廚房、主人睡房、睡房1及睡房2	
					A	主人睡房	
					B	睡房1	
					D及G	客廳、主人睡房及睡房1	
E及H	客廳						
F	客廳、廚房、主人睡房、睡房1及睡房2						
49樓	A	客廳、飯廳、廚房、主人睡房、睡房1、睡房2及睡房3					
	B	客廳、飯廳、廚房、主人睡房、睡房1及睡房3					

Note: 4/F, 13/F, 14/F, 24/F, 34/F and 44/F are omitted. 25/F is refuge floor.

備註：不設4樓、13樓、14樓、24樓、34樓及44樓。25樓為庇護層。

1. EXTERIOR FINISHES

Item		Description				
(b)	Window	Curtain Wall	Material of the frame and glass		Aluminium window frame with Insulated Glass Unit (IGU) of tinted low-e coating glass for the following residential units	
			Tower		Unit	Location
			Tower 3	5/F - 12/F, 15/F - 23/F, 26/F - 33/F, 35/F - 43/F & 45/F - 49/F	A & H	Living room, Master bedroom, Bedroom 1 and Bedroom 2
					B & C	Living room, Master bedroom and Bedroom 1
					D & J	Master bedroom and Bedroom 1
					E, F & G	Living room and Master bedroom
			50/F & 51/F	C	Master bedroom, Bedroom 1 and Bedroom 2	
				D	Living room and Master bedroom	
				E	Living room, Dining room, Master bedroom, Bedroom 1 and Bedroom 2	
				F	Master bedroom and Bedroom 1	
			50/F & 51/F	A (Duplex Unit)	Living room, Dining room, Family room, Master bedroom, Bedroom 1, Bedroom 2, Bedroom 3 and Bathroom 2	
				B (Duplex Unit)	Living room, Dining room, Master bedroom, Bedroom 2 and Bedroom 3	

1. 外部裝修物料

細項		描述				
(b)	窗	幕牆	框及玻璃的用料		裝設幕牆鋁框配有色低輻射鍍膜中空玻璃 (IGU) 於以下住宅單位	
			座數		單位	位置
			第3座	5樓-12樓、15樓-23樓、26樓-33樓、35樓-43樓及45樓-49樓	A及H	客廳、主人睡房、睡房1及睡房2
					B及C	客廳、主人睡房及睡房1
					D及J	主人睡房及睡房1
					E、F及G	客廳及主人睡房
			50樓及51樓	C	主人睡房、睡房1及睡房2	
				D	客廳及主人睡房	
				E	客廳、飯廳、主人睡房、睡房1及睡房2	
			50樓及51樓	F	主人睡房及睡房1	
				A (複式單位)	客廳、飯廳、家庭室、主人睡房、睡房1、睡房2、睡房3及浴室2	
			B (複式單位)	客廳、飯廳、主人睡房、睡房2及睡房3		

Note: 4/F, 13/F, 14/F, 24/F, 34/F and 44/F are omitted. 25/F is refuge floor.

備註：不設4樓、13樓、14樓、24樓、34樓及44樓。25樓為庇護層。

1. EXTERIOR FINISHES

Item		Description				
(b)	Window	Curtain Wall	Material of the frame and glass	Aluminium window frame with Insulated Glass Unit (IGU) of tinted low-e coating glass for the following residential units		
			Tower	Unit	Location	
			Tower 5	5/F - 12/F, 15/F - 23/F, 26/F - 33/F, 35/F - 43/F & 45/F - 49/F	A	Living room, Master bedroom, Bedroom 1 and Bedroom 2
					B, C & H	Living room, Master bedroom and Bedroom 1
					D & J	Master bedroom and Bedroom 1
					E, F & G	Living room and Master bedroom
					C & F	Master bedroom and Bedroom 1
				50/F	D	Living room and Master bedroom
					E	Living room, Dining room, Master bedroom, Bedroom 1, Bedroom 2 and Bedroom 3
				51/F	C & F	Master bedroom and Bedroom 1
					D	Living room and Master bedroom
				50/F & 51/F	E	Living room, Dining room, Master bedroom, Bedroom 1, Bedroom 2 and Bedroom 3
			A (Duplex Unit)		Living room, Dining room, Family room, Bedroom 1, Bedroom 2, Bedroom 3 and Bathroom 3	
			B (Duplex Unit)	Living room, Dining room, Master bedroom, Bedroom 2 and Bedroom 3		

1. 外部裝修物料

細項		描述			
(b)	窗	幕牆	框及玻璃的用料	裝設幕牆鋁框配有色低輻射鍍膜中空玻璃 (IGU) 於以下住宅單位	
			座數	單位	位置
			5樓-12樓、15樓-23樓、26樓-33樓、35樓-43樓及45樓-49樓	A	客廳、主人睡房、睡房1及睡房2
				B、C及H	客廳、主人睡房及睡房1
				D及J	主人睡房及睡房1
				E、F及G	客廳及主人睡房
			50樓	C及F	主人睡房及睡房1
				D	客廳及主人睡房
			51樓	E	客廳、飯廳、主人睡房、睡房1、睡房2及睡房3
				C及F	主人睡房及睡房1
			50樓及51樓	D	客廳及主人睡房
				E	客廳、飯廳、主人睡房、睡房1、睡房2及睡房3
				A (複式單位)	客廳、飯廳、家庭室、睡房1、睡房2、睡房3及浴室3
				B (複式單位)	客廳、飯廳、主人睡房、睡房2及睡房3

Note: 4/F, 13/F, 14/F, 24/F, 34/F and 44/F are omitted. 25/F is refuge floor.

備註：不設4樓、13樓、14樓、24樓、34樓及44樓。25樓為庇護層。

1. EXTERIOR FINISHES

Item		Description					
(b)	Window	Window	Material of the frame and glass	Aluminium window frames finished with tinted tempered glass for the following residential units			
			Tower 1	5/F - 12/F, 15/F - 23/F, 26/F - 33/F, 35/F - 43/F & 45/F - 48/F	A	Kitchen	
					G	Kitchen and Master bedroom	
					H	Kitchen and Master bedroom	
					49/F	A	Bedroom 1 and Utility room
						C	Master bedroom and Dining room
						C	Kitchen
			Tower 2	5/F - 12/F, 15/F - 23/F, 26/F - 33/F, 35/F - 43/F & 45/F - 48/F	D	Kitchen	
					E	Living room and Open kitchen	
					F	Dining room	
					G	Kitchen	
					H	Living room	
					49/F	A	Interior Staircase
			B	Corridor & Bedroom 2			

1. 外部裝修物料

細項		描述					
(b)	窗	窗	框及玻璃的用料	鋁窗框配有強化玻璃於以下住宅單位			
			第1座	5樓-12樓、15樓-23樓、26樓-33樓、35樓-43樓及45樓-48樓	A	廚房	
					G	廚房及主人睡房	
					H	廚房及主人睡房	
					49樓	A	睡房1及工作間
						C	主人睡房及飯廳
						C	廚房
			第2座	5樓-12樓、15樓-23樓、26樓-33樓、35樓-43樓及45樓-48樓	D	廚房	
					E	客廳及開放式廚房	
					F	飯廳	
					G	廚房	
					H	客廳	
					49樓	A	室內樓梯
						B	走廊及睡房2

Note: 4/F, 13/F, 14/F, 24/F, 34/F and 44/F are omitted. 25/F is refuge floor.

備註：不設4樓、13樓、14樓、24樓、34樓及44樓。25樓為庇護層。

1. EXTERIOR FINISHES

Item		Description				
(b)	Window	Window	Material of the frame and glass	Aluminium window frames finished with tinted tempered glass for the following residential units		
			Tower 3	5/F - 12/F, 15/F - 23/F, 26/F - 33/F, 35/F - 43/F & 45/F - 49/F	A	Dining room and Kitchen
					B	Open kitchen
					C	Living room, Kitchen, Master bedroom, Bedroom 2 and Utility room (next to Master Bathroom)
					D	Kitchen, Master bedroom and Bedroom 2
					H & J	Kitchen
				50/F & 51/F	C	Kitchen
					E	Kitchen and Bedroom 3
					F	Kitchen
				50/F & 51/F	A (Duplex Unit)	Kitchen and Master bedroom
					B (Duplex Unit)	Living room, Kitchen and Bedroom 1

1. 外部裝修物料

細項		描述				
(b)	窗	窗	框及玻璃的用料	鋁窗框配有強化玻璃於以下住宅單位		
			第3座	5樓-12樓、15樓-23樓、26樓-33樓、35樓-43樓及45樓-49樓	A	飯廳及廚房
					B	開放式廚房
					C	客廳、廚房、主人睡房、睡房2及工作間(主人浴室旁邊)
					D	廚房、主人睡房及睡房2
					H及J	廚房
				50樓及51樓	C	廚房
					E	廚房及睡房3
					F	廚房
				50樓及51樓	A (複式單位)	廚房及主人睡房
					B (複式單位)	客廳、廚房及睡房1

Note: 4/F, 13/F, 14/F, 24/F, 34/F and 44/F are omitted. 25/F is refuge floor.

備註：不設4樓、13樓、14樓、24樓、34樓及44樓。25樓為庇護層。

1. EXTERIOR FINISHES

Item		Description				
(b)	Window	Window	Material of the frame and glass	Aluminium window frames finished with tinted tempered glass for the following residential units		
			Tower 5	5/F - 12/F, 15/F - 23/F, 26/F - 33/F, 35/F - 43/F & 45/F - 49/F	A	Dining room and Kitchen
					B	Open Kitchen
					C	Living Room, Kitchen, Master bedroom, Bedroom 2 and Utility room (next to Master bathroom)
					D	Kitchen, Master bedroom and Bedroom 2
					H & J	Kitchen
					C	Master bedroom, Bedroom 2 and Kitchen
			50/F & 51/F	E	Kitchen and Store room	
				F	Kitchen	
				A (Duplex Unit)	Kitchen, Dining room and Master bedroom	
			50/F & 51/F	A (Duplex Unit)	Kitchen, Living room and Bedroom 1	

1. 外部裝修物料

細項		描述				
(b)	窗	窗	框及玻璃的用料	鋁窗框鑲有色強化玻璃於以下住宅單位		
			第5座	5樓-12樓、15樓-23樓、26樓-33樓、35樓-43樓及45樓-49樓	A	飯廳及廚房
					B	開放式廚房
					C	客廳、廚房、主人睡房、睡房2及工作間 (主人浴室旁邊)
					D	廚房、主人睡房及睡房2
					H及J	廚房
					C	主人睡房、睡房2及廚房
			50樓及51樓	E	廚房及儲物室	
				F	廚房	
				A (複式單位)	廚房、飯廳及主人睡房	
			50樓及51樓	B (複式單位)	廚房、客廳及睡房1	

Note: 4/F, 13/F, 14/F, 24/F, 34/F and 44/F are omitted. 25/F is refuge floor.

備註：不設4樓、13樓、14樓、24樓、34樓及44樓。25樓為庇護層。

1. EXTERIOR FINISHES

Item		Description				
(b)	Window	Window	Material of the frame and glass	Aluminium window frames finished with obscured glass for the following residential units		
			Tower	Unit	Location	
			Tower 1	5/F - 12/F, 15/F - 23/F, 26/F - 33/F, 35/F - 43/F & 45/F - 48/F	H	Utility room
			Tower 2	5/F - 12/F, 15/F - 23/F, 26/F - 33/F, 35/F - 43/F & 45/F - 48/F	D	Dining room and Utility room
					E	Master bedroom
					G	Master bedroom and Utility room
				49/F	B	Bedroom 3
			Tower 3	5/F - 12/F, 15/F - 23/F, 26/F - 33/F, 35/F - 43/F & 45/F - 49/F	A	Bedroom 2
					B	Bedroom 1
					H	Utility room
			Tower 5	5/F - 12/F, 15/F - 23/F, 26/F - 33/F, 35/F - 43/F & 45/F - 49/F	A	Bedroom 2
					B	Bedroom 1
50/F & 51/F	A (Duplex Unit)	Bedroom 2				
Bathroom and Lavatory		Aluminium window frames finished with fluorocarbon coating fitted with obscured glass if window is provided				

Note: 4/F, 13/F, 14/F, 24/F, 34/F and 44/F are omitted. 25/F is refuge floor.

1. 外部裝修物料

細項		描述				
(b)	窗	窗	框及玻璃的用料	鋁窗框配磨砂玻璃於以下住宅單位		
			座數	單位	位置	
			第1座	5樓-12樓、15樓-23樓、26樓-33樓、35樓-43樓及45樓-48樓	H	工作間
			第2座	5樓-12樓、15樓-23樓、26樓-33樓、35樓-43樓及45樓-48樓	D	飯廳及工作間
					E	主人睡房
					G	主人睡房及工作間
				49樓	B	睡房3
			第3座	5樓-12樓、15樓-23樓、26樓-33樓、35樓-43樓及45樓-49樓	A	睡房2
					B	睡房1
					H	工作間
			第5座	5樓-12樓、15樓-23樓、26樓-33樓、35樓-43樓及45樓-49樓	A	睡房2
					B	睡房1
50樓及51樓	A (複式單位)	睡房2				
浴室及洗手間		鋁窗框配有氟化碳噴塗層鑲磨砂玻璃 (如有窗)				

備註：不設4樓、13樓、14樓、24樓、34樓及44樓。25樓為庇護層。

1. EXTERIOR FINISHES

Item		Description			
(c)	Bay window	Material of bay window	Not applicable		
		Window sill finishes	Not applicable		
(d)	Planter	Type of finishes	Not applicable		
(e)	Verandah or balcony	(i) Type of finishes	Balcony: Installed with laminated glass balustrade and aluminium top rail		
			Balcony Floor: Artificial wood deck		
			Balcony Wall (if any)		
			Finished with aluminium cladding		
			Tower		Unit
			Tower 1	5/F	B
				6/F - 12/F, 15/F - 23/F, 26/F - 33/F, 35/F - 43/F & 45/F - 48/F	A, B, F, G & H
				49/F	C
			Tower 2	6/F - 12/F, 15/F - 23/F, 26/F - 33/F, 35/F - 43/F & 45/F - 48/F	A, B, C & D
				49/F	B
			Tower 3	6/F - 12/F, 15/F - 23/F, 26/F - 33/F, 35/F - 43/F & 45/F - 49/F	A, B, C, D & H
				50/F - 51/F	C & E
				50/F & 51/F	51/F of B (Duplex Unit)
			Tower 5	6/F - 12/F, 15/F - 23/F, 26/F - 33/F, 35/F - 43/F & 45/F - 49/F	C, D & H
				50/F - 51/F	C & E
				50/F & 51/F	51/F of B (Duplex Unit)
			Finished with aluminium cladding and tiles		
			Tower		Unit
			Tower 1	5/F - 12/F, 15/F - 23/F, 26/F - 33/F, 35/F - 43/F & 45/F - 48/F	C & D
				49/F	A & B
			Tower 3	6/F - 12/F, 15/F - 23/F, 26/F - 33/F, 35/F - 43/F & 45/F - 49/F	E, F & G
				50/F - 51/F	D
			Tower 5	6/F - 12/F, 15/F - 23/F, 26/F - 33/F, 35/F - 43/F & 45/F - 49/F	A, E, F & G
				50/F - 51/F	D

Note: 4/F, 13/F, 14/F, 24/F, 34/F and 44/F are omitted. 25/F is refuge floor.

1. 外部裝修物料

細項		描述			
(c)	窗台	窗台的用料	不適用		
		窗台板的裝修物料	不適用		
(d)	花槽	裝修物料的类型	不適用		
(e)	陽台或露台	(i) 裝修物料的类型	露台：裝有夾層玻璃圍欄及鋁料扶手		
			露台地台：人造木平台		
			露台牆身（如有）		
			裝有鋁飾板		
			座數		單位
			第1座	5樓	B
				6樓-12樓、15樓-23樓、26樓-33樓、35樓-43樓及45樓-48樓	A、B、F、G及H
				49樓	C
			第2座	6樓-12樓、15樓-23樓、26樓-33樓、35樓-43樓及45樓-48樓	A、B、C及D
				49樓	B
			第3座	6樓-12樓、15樓-23樓、26樓-33樓、35樓-43樓及45樓-49樓	A、B、C、D及H
				50樓-51樓	C及E
				50樓及51樓	B（複式單位）的51樓
			第5座	6樓-12樓、15樓-23樓、26樓-33樓、35樓-43樓及45樓-49樓	C、D及H
				50樓-51樓	C及E
				50樓及51樓	B（複式單位）的51樓
			裝有鋁飾板及鋪砌瓷磚		
			座數		單位
			第1座	5樓-12樓、15樓-23樓、26樓-33樓、35樓-43樓及45樓-48樓	C及D
				49樓	A及B
			第3座	6樓-12樓、15樓-23樓、26樓-33樓、35樓-43樓及45樓-49樓	E、F及G
				50樓-51樓	D
			第5座	6樓-12樓、15樓-23樓、26樓-33樓、35樓-43樓及45樓-49樓	A、E、F及G
				50樓-51樓	D

備註：不設4樓、13樓、14樓、24樓、34樓及44樓。25樓為庇護層。

1. EXTERIOR FINISHES

Item		Description			
(e)	Verandah or balcony	(i) Type of finishes	Finished with tiles		
			Tower		Unit
			Tower 1	6/F - 12/F, 15/F - 23/F, 26/F - 33/F, 35/F - 43/F & 45/F - 48/F	E
			Tower 2	6/F - 12/F, 15/F - 23/F, 26/F - 33/F, 35/F - 43/F & 45/F - 48/F	E, F, G & H
			Tower 3	6/F - 12/F, 15/F - 23/F, 26/F - 33/F, 35/F - 43/F & 45/F - 49/F	J
				50/F - 51/F	F
			Tower 5	6/F - 12/F, 15/F - 23/F, 26/F - 33/F, 35/F - 43/F & 45/F - 49/F	J
				50/F - 51/F	F
			Balcony ceiling: Installed with aluminium ceiling at the balcony, except the balcony ceiling installed with aluminium acoustic ceiling at the balcony for the following residential units.		
			Tower		Unit
			Tower 1	6/F - 12/F, 15/F - 23/F, 26/F - 33/F, 35/F - 43/F & 45/F - 48/F	F, G & H
				49/F	C
			Tower 2	6/F - 12/F, 15/F - 23/F, 26/F - 33/F, 35/F - 43/F & 45/F - 48/F	A, B, D, E & F
			Tower 3	6/F - 12/F, 15/F - 23/F, 26/F - 33/F, 35/F - 43/F & 45/F - 48/F	B
(ii) Whether it is covered	Balcony is covered				
Verandah	Not applicable				
(f)	Drying facilities for clothing	Type	Not applicable		
		Material	Not applicable		

1. 外部裝修物料

細項		描述			
(e)	陽台或露台	(i) 裝修物料 的類型	鋪砌瓷磚		
			座數		單位
			第1座	6樓-12樓、15樓-23樓、 26樓-33樓、35樓-43樓及45樓-48樓	E
			第2座	6樓-12樓、15樓-23樓、 26樓-33樓、35樓-43樓及45樓-48樓	E、F、G及H
			第3座	6樓-12樓、15樓-23樓、 26樓-33樓、35樓-43樓及45樓-49樓	J
				50樓-51樓	F
			第5座	6樓-12樓、15樓-23樓、 26樓-33樓、35樓-43樓及45樓-49樓	J
				50樓-51樓	F
			露台天花：露台裝有鋁天花，除以下住宅單位裝有鋁減音天花		
			座數		單位
			第1座	6樓-12樓、15樓-23樓、 26樓-33樓、35樓-43樓及45樓-48樓 49樓	F、G及H C
			第2座	6樓-12樓、15樓-23樓、 26樓-33樓、35樓-43樓及45樓-48樓	A、B、D、E及F
			第3座	6樓-12樓、15樓-23樓、 26樓-33樓、35樓-43樓及45樓-48樓	B
			(ii) 是否有蓋	露台設有上蓋	
陽台	不適用				
(f)	乾衣設施	類型	不適用		
		用料	不適用		

Note: 4/F, 13/F, 14/F, 24/F, 34/F and 44/F are omitted. 25/F is refuge floor.

備註：不設4樓、13樓、14樓、24樓、34樓及44樓。25樓為庇護層。

2. INTERIOR FINISHES

Item		Description			
		Wall	Floor	Ceiling	
(a)	Lobby	P/F residential entrance lobby finishes	Natural stone and metal	Natural stone	Ceiling finished with emulsion paint where exposed and gypsum board bulkhead finished with emulsion paint.
		Lift lobby finishes for residential floors	Wood, plastic laminate and metal	Natural stone and metal	Ceiling finished with emulsion paint where exposed and gypsum board bulkhead finished with emulsion paint.
		Residential shuttle lift lobby finishes	B/F & G/F: Natural stone, wood veneer, metal and emulsion paint where exposed P/F: Natural Stone, wood veneer, metal, glass and emulsion paint where exposed	Natural stone and metal	Gypsum board ceiling and bulkhead finished with emulsion paint where exposed.

2. 室內裝修物料

細項		描述			
		牆壁	地板	天花板	
(a)	大堂	基座平台住宅入口大堂的裝修物料的類型	天然石及金屬	天然石	外露天花板髹乳膠漆及石膏板假陣髹乳膠漆
		住宅樓層升降機大堂裝修物料的類型	木、塑料層壓板及金屬	天然石及金屬	外露天花板髹乳膠漆及石膏板假陣髹乳膠漆
		住宅穿梭升降機大堂裝修物料的類型	地庫及地下： 天然石、木皮飾面、金屬及外露牆身髹乳膠漆 基座平台： 天然石、木皮飾面、金屬、玻璃及外露牆身髹乳膠漆	天然石及金屬	外露石膏板天花和假陣髹乳膠漆

Note: 4/F, 13/F, 14/F, 24/F, 34/F and 44/F are omitted. 25/F is refuge floor.

備註：不設4樓、13樓、14樓、24樓、34樓及44樓。25樓為庇護層。

2. INTERIOR FINISHES

Item		Description						
		Wall		Ceiling				
(b)	Internal wall and ceiling	Living room and Dining room finishes	Walls finished with emulsion paint (apart from area covered by cabinet & area covered by bulkhead at which there are no wall finishes), except following residential units finished with emulsion paint with melamine feature wall (apart from area covered by cabinet & area covered by bulkhead at which there are no wall finishes).		Ceiling finished with emulsion paint where exposed and gypsum board bulkhead finished with emulsion paint.			
			Tower		Unit			
			Tower 1	5/F - 12/F, 15/F - 23/F, 26/F - 33/F, 35/F - 43/F & 45/F - 48/F	B, C & F		Ceiling finished with emulsion paint where exposed and gypsum board bulkhead finished with emulsion paint.	
				49/F	A, B & C		Ceiling finished with emulsion paint where exposed and gypsum board false ceiling finished with emulsion paint.	
			Tower 2	5/F - 12/F, 15/F - 23/F, 26/F - 33/F, 35/F - 43/F & 45/F - 48/F	A, E & H		Ceiling finished with emulsion paint where exposed and gypsum board bulkhead finished with emulsion paint.	
				49/F	A & B		Ceiling finished with emulsion paint where exposed and gypsum board false ceiling finished with emulsion paint.	

Note: 4/F, 13/F, 14/F, 24/F, 34/F and 44/F are omitted. 25/F is refuge floor.

2. 室內裝修物料

細項		描述				
		牆壁		天花板		
(b)	內牆及天花板	客廳及飯廳的裝修物料的类型	除以下住宅單位之牆身髹乳膠漆及三聚氰胺貼面裝置牆（不包括櫃背牆身、裝飾橫樑遮蓋之牆身、該處之牆身不設裝修物料），所有牆身髹乳膠漆（不包括櫃背牆身、裝飾橫樑遮蓋之牆身、該處之牆身不設裝修物料）。		外露天花板髹乳膠漆及石膏板假陣髹乳膠漆	
			座數		單位	
			第1座	5樓-12樓、15樓-23樓、26樓-33樓、35樓-43樓及45樓-48樓	B、C及F	外露天花板髹乳膠漆及石膏板假陣髹乳膠漆
				49樓	A、B及C	外露天花板髹乳膠漆及石膏板假天花髹乳膠漆
			第2座	5樓-12樓、15樓-23樓、26樓-33樓、35樓-43樓及45樓-48樓	A、E及H	外露天花板髹乳膠漆及石膏板假陣髹乳膠漆
				49樓	A及B	外露天花板髹乳膠漆及石膏板假天花髹乳膠漆

備註：不設4樓、13樓、14樓、24樓、34樓及44樓。25樓為庇護層。

2. INTERIOR FINISHES

Item	Description				
	Wall		Ceiling		
(b) Internal wall and ceiling	Living room and Dining room finishes	Walls finished with emulsion paint (apart from area covered by cabinet & area covered by bulkhead at which there are no wall finishes), except following residential units finished with emulsion paint with melamine feature wall (apart from area covered by cabinet & area covered by bulkhead at which there are no wall finishes).		Ceiling finished with emulsion paint where exposed and gypsum board bulkhead finished with emulsion paint.	
		Tower 3	5/F - 12/F, 15/F - 23/F, 26/F - 33/F, 35/F - 43/F & 45/F - 49/F	E, F & G	Ceiling finished with emulsion paint where exposed and gypsum board bulkhead finished with emulsion paint.
				D	
		Tower 5	5/F - 12/F, 15/F - 23/F, 26/F - 33/F, 35/F - 43/F & 45/F - 49/F	E, F & G	Ceiling finished with emulsion paint where exposed and gypsum board bulkhead finished with emulsion paint.
				D	
		Tower 3	50/F - 51/F	A & B (Duplex Unit)	Ceiling finished with emulsion paint where exposed and gypsum board false ceiling finished with emulsion paint.
				D	
		Tower 5	50/F - 51/F	A & B (Duplex Unit)	Ceiling finished with emulsion paint where exposed and gypsum board false ceiling finished with emulsion paint.
				D	
		Bedroom finishes	Wall of Master bedroom and Bedroom(s) finished with emulsion paint, except area above the false ceiling level and area covered by bulkhead at which there are no wall finishes		Ceiling finished with emulsion paint where exposed and gypsum board bulkhead finished with emulsion paint.

2 室內裝修物料

細項	描述				
	牆壁		天花板		
(b) 內牆及天花板	客廳及飯廳的裝修物料的类型	除以下住宅單位之牆身髹乳膠漆及三聚氰胺貼面裝置牆（不包括櫃背牆身、裝飾橫樑遮蓋之牆身、該處之牆身不設裝修物料），所有牆身髹乳膠漆（不包括櫃背牆身、裝飾橫樑遮蓋之牆身、該處之牆身不設裝修物料）。		外露天花板髹乳膠漆及石膏板假陣髹乳膠漆	
		第3座	5樓-12樓、15樓-23樓、26樓-33樓、35樓-43樓及45樓-49樓	E、F及G	外露天花板髹乳膠漆及石膏板假陣髹乳膠漆
			50樓-51樓	D	
		第5座	50樓及51樓	A及B (複式單位)	外露天花板髹乳膠漆及石膏板假天花髹乳膠漆
			5樓-12樓、15樓-23樓、26樓-33樓、35樓-43樓及45樓-49樓	E、F及G	外露天花板髹乳膠漆及石膏板假陣髹乳膠漆
			50樓-51樓	D	
			50樓及51樓	A及B (複式單位)	外露天花板髹乳膠漆及石膏板假天花髹乳膠漆
		睡房的裝修物料的类型	主人睡房及睡房之牆身髹乳膠漆、不包括假天花以上及裝飾橫樑遮蓋之牆身、該處之牆身不設裝修物料。		外露天花板髹乳膠漆及石膏板假陣髹乳膠漆

Note: 4/F, 13/F, 14/F, 24/F, 34/F and 44/F are omitted. 25/F is refuge floor.

備註：不設4樓、13樓、14樓、24樓、34樓及44樓。25樓為庇護層。

2. INTERIOR FINISHES

Item	Description				Skirting			
	Floor							
(c)	Internal Floor	Material for Living room and Dining room		Floor finished with engineered timber flooring, metal trimming and natural stone.		Timber skirting		
		Material for Bedroom		Floor finished with engineered timber flooring, except floor of the following residential units finished with engineered timber flooring, metal trimming and natural stone border along the edge of floor adjoining door to Balcony or Utility platform or Flat roof.		Timber skirting		
	Tower			Unit	Location			
	Tower 1			5/F - 12/F, 15/F - 23/F, 26/F - 33/F, 35/F - 43/F & 45/F - 48/F			A, D & E	Master bedroom
				6/F - 12/F, 15/F - 23/F, 26/F - 33/F, 35/F - 43/F & 45/F - 48/F			G	Master bedroom
				49/F			A & B	Master bedroom and Bedroom 2
							C	Master bedroom
	Tower 2			5/F			G	Bedroom 1
				5/F - 12/F, 15/F - 23/F, 26/F - 33/F, 35/F - 43/F & 45/F - 48/F			B, C, D, E & F	Master bedroom
				6/F - 12/F, 15/F - 23/F, 26/F - 33/F, 35/F - 43/F & 45/F - 48/F			G	Master bedroom
				49/F			A	Bedroom 3
							B	Master bedroom and Bedroom 3

2. 室內裝修物料

細項	描述				牆腳線			
	地板							
(c)	內部地板	客廳及飯廳的用料		地板鋪砌複合木地板、金屬條及天然石。		木牆腳線		
		睡房的用料		除以下住宅單位之地板鋪砌複合木地板、金屬條及天然石圍邊於相連露台或工作平台或平台的門，所有地板鋪砌複合木地板。				
				座數		單位	位置	
				第1座	5樓-12樓、15樓-23樓、26樓-33樓、35樓-43樓及45樓-48樓		A、D及E	主人睡房
					6樓-12樓、15樓-23樓、26樓-33樓、35樓-43樓及45樓-48樓		G	主人睡房
					49樓		A及B	主人睡房及睡房2
							C	主人睡房
				第2座	5樓		G	睡房1
					5樓-12樓、15樓-23樓、26樓-33樓、35樓-43樓及45樓-48樓		B、C、D、E及F	主人睡房
					6樓-12樓、15樓-23樓、26樓-33樓、35樓-43樓及45樓-48樓		G	主人睡房
					49樓		A	睡房3
							B	主人睡房及睡房3

Note: 4/F, 13/F, 14/F, 24/F, 34/F and 44/F are omitted. 25/F is refuge floor.

備註：不設4樓、13樓、14樓、24樓、34樓及44樓。25樓為庇護層。

2. INTERIOR FINISHES

Item		Description			Skirting		
		Floor					
(c)	Internal Floor	Material for Living room and Dining room	Floor finished with engineered timber flooring, metal trimming and natural stone.			Timber skirting	
		Material for Master bedroom/ Bedroom	Floor finished with engineered timber flooring, except floor of the following residential units finished with engineered timber flooring, metal trimming and natural stone border along the edge of floor adjoining door to Balcony or Utility platform or door to Flat roof.			Timber skirting	
	Tower		Unit	Location			
	Tower 3		6/F - 12/F, 15/F - 23/F, 26/F - 33/F, 35/F - 43/F & 45/F - 49/F	B	Master bedroom		
			5/F - 12/F, 15/F - 23/F, 26/F - 33/F, 35/F - 43/F & 45/F - 49/F	C, D, E, F, G, H & J	Master bedroom		
			50/F - 51/F	D, E & F	Master bedroom		
			50/F	C	Master bedroom and Bedroom 2		
			51/F	B (Duplex Unit)	Master bedroom		
				C	Bedroom 2		
			5/F	C	Bedroom 2		
	Tower 5		5/F - 12/F, 15/F - 23/F, 26/F - 33/F, 35/F - 43/F & 45/F - 49/F	C, D, E, F, G, H & J	Master bedroom		
			50/F - 51/F	C, D, E & F	Master bedroom		
			51/F	B (Duplex Unit)	Master bedroom		

2. 室內裝修物料

細項		描述			牆腳線			
		地板						
(c)	內部地板	客廳及飯廳的用料	地板鋪砌複合木地板、金屬條及天然石。			木牆腳線		
		主人睡房/睡房的用料	除以下住宅單位之地板鋪砌複合木地板、金屬條及天然石圍邊於相連露台或工作平台或平台，所有地板鋪砌複合木地板。			木牆腳線		
			座數	單位	位置			
			第3座	6樓-12樓、15樓-23樓、26樓-33樓、35樓-43樓及45樓-49樓	B		主人睡房	
				5樓-12樓、15樓-23樓、26樓-33樓、35樓-43樓及45樓-49樓	C、D、E、F、G、H及J		主人睡房	
				50樓-51樓	D、E及F		主人睡房	
				50樓	C		主人睡房及睡房2	
				51樓	B (複式單位)		主人睡房	
					C		睡房2	
				5樓	C		睡房2	
			第5座	5樓-12樓、15樓-23樓、26樓-33樓、35樓-43樓及45樓-49樓	C、D、E、F、G、H及J		主人睡房	
				50樓-51樓	C、D、E及F		主人睡房	
				51樓	B (複式單位)		主人睡房	

Note: 4/F, 13/F, 14/F, 24/F, 34/F and 44/F are omitted. 25/F is refuge floor.

備註：不設4樓、13樓、14樓、24樓、34樓及44樓。25樓為庇護層。

2. INTERIOR FINISHES

Item	Description							
		Wall	Floor	Ceiling				
(d)	Bathroom	(i) Type of finishes	Master bathroom/ Bathroom	Wall finished with tiles, except the wall of the following residential units finished with natural stone.		Natural stone	Gypsum board false ceiling finished with emulsion paint	
				Tower		Unit		
				Tower 1	5/F - 12/F, 15/F - 23/F, 26/F - 33/F, 35/F - 43/F & 45/F - 48/F	A	Natural Stone	Gypsum board false ceiling with emulsion paint
					49/F	A, B & C		
				Tower 2	5/F - 12/F, 15/F - 23/F, 26/F - 33/F, 35/F - 43/F & 45/F - 49/F	C & F		
					49/F	A & B		
				Tower 3	5/F - 12/F, 15/F - 23/F, 26/F - 33/F, 35/F - 43/F & 45/F - 49/F	C & H		
					50/F & 51/F	A (Duplex Unit), B (Duplex Unit), C & E		
				Tower 5	5/F - 12/F, 15/F - 23/F, 26/F - 33/F, 35/F - 43/F & 45/F - 49/F	C		
					50/F & 51/F	A (Duplex), B (Duplex) & E		

Note: 4/F, 13/F, 14/F, 24/F, 34/F and 44/F are omitted. 25/F is refuge floor.

2. 室內裝修物料

細項	描述					地板	天花板	
			牆壁	單位				
(d)	浴室	(i) 裝修物料 的類型	主人浴室/ 浴室	除以下住宅單位之牆身鋪砌天然石，所有牆身鋪砌瓷磚。		天然石	石膏板假天花髹乳膠漆	
				座數		單位		
				第1座	5樓-12樓、15樓-23樓、26樓-33樓、35樓-43樓及45樓-48樓	A	天然石	石膏板假天花 乳膠漆
					49樓	A、B及C		
				第2座	5樓-12樓、15樓-23樓、26樓-33樓、35樓-43樓及45樓-49樓	C及F		
					49樓	A及B		
				第3座	5樓-12樓、15樓-23樓、26樓-33樓、35樓-43樓及45樓-49樓	C及H		
					50樓及51樓	A(複式單位)、B(複式單位)、C及E		
				第5座	5樓-12樓、15樓-23樓、26樓-33樓、35樓-43樓及45樓-49樓	C		
					50樓及51樓	A(複式單位)、B(複式單位)及E		

備註：不設4樓、13樓、14樓、24樓、34樓及44樓。25樓為庇護層。

2. INTERIOR FINISHES

Item	Description										
	Wall			Floor			Ceiling				
(d) Bathroom	(i) Type of finishes	Lavatory	Wall finished with natural wall tiles except the following residential unit finished with natural stone			Floor finished with floor tiles except the following residential unit finished with natural stone			Ceiling finished with aluminium false ceiling with louver except the following residential unit finished with gypsum board false ceiling with emulsion paint		
			Tower	Unit	Tower	Unit	Tower	Unit			
		Tower 1	49/F	C	Tower 1	49/F	C	Tower 1	49/F	C	
		Lavatory 1	Wall finished with natural wall tiles except the following residential unit finished with natural stone			Floor finished with floor tiles except the following residential unit finished with natural stone			Ceiling finished with aluminium false ceiling with louver except the following residential unit finished with gypsum board false ceiling with emulsion paint		
			Tower	Unit	Tower	Unit	Tower	Unit			
		Tower 3 & 5	50/F	A (Duplex Unit)	Tower 3 & 5	50/F	A (Duplex Unit)	Tower 3 & 5	50/F	A (Duplex Unit)	
	Lavatory 2	Wall finished with natural wall tiles except the following residential unit finished with natural stone			Floor finished with floor tiles except the following residential unit finished with natural stone			Ceiling finished with aluminium false ceiling with louver except the following residential unit finished with gypsum board false ceiling with emulsion paint			
		Tower	Unit	Tower	Unit	Tower	Unit				
	Tower 3 & 5	50/F	B (Duplex Unit)	Tower 3 & 5	50/F	B (Duplex Unit)	Tower 3 & 5	50/F	B (Duplex Unit)		
	(ii) Whether the wall finishes run up to the ceiling	Up to level of false ceiling									

2. 室內裝修物料

細項	描述										
	牆壁			地板			天花板				
(d) 浴室	(i) 裝修物料的类型	洗手間	除以下住宅單位之牆身鋪砌天然石材，所有單位牆身鋪砌瓷磚。			除以下住宅單位之地板鋪砌天然石材，所有單位地板鋪砌地台瓷磚。			除以下住宅單位之天花板鋪砌石膏板假天花髹乳膠漆，所有單位天花板鋪砌鋁質假天花。		
			座數	單位	座數	單位	座數	單位			
		第1座	49樓	C	第1座	49樓	C	第1座	49樓	C	
		洗手間1	除以下住宅單位之牆身鋪砌天然石材，所有單位牆身鋪砌瓷磚。			除以下住宅單位之地板鋪砌天然石材，所有單位地板鋪砌地台瓷磚。			除以下住宅單位之天花板鋪砌石膏板假天花髹乳膠漆，所有單位天花板鋪砌鋁質假天花。		
			座數	單位	座數	單位	座數	單位			
		第3座及第5座	50樓	A (複式單位)	第3座及第5座	50樓	A (複式單位)	第3座及第5座	50樓	A (複式單位)	
	洗手間2	除以下住宅單位之牆身鋪砌天然石材，所有單位牆身鋪砌瓷磚。			除以下住宅單位之地板鋪砌天然石材，所有單位地板鋪砌地台瓷磚。			除以下住宅單位之天花板鋪砌石膏板假天花髹乳膠漆，所有單位天花板鋪砌鋁質假天花。			
		座數	單位	座數	單位	座數	單位				
	第3座及第5座	50樓	B (複式單位)	第3座及第5座	50樓	B (複式單位)	第3座及第5座	50樓	B (複式單位)		
	(ii) 牆壁的裝修物料是否鋪至天花板	裝修物料鋪至假天花底									

Note: 4/F, 13/F, 14/F, 24/F, 34/F and 44/F are omitted. 25/F is refuge floor.

備註：不設4樓、13樓、14樓、24樓、34樓及44樓。25樓為庇護層。

2. INTERIOR FINISHES

Item		Description							
		Wall			Floor	Ceiling	Cooking Bench		
(e)	Kitchen	(i) Type of finishes	Open kitchen	Wall finished with plastic laminate, engineered stone and tiles (except areas covered by hanging kitchen cabinets, areas above the false ceiling level and areas covered by bulkhead at which there are no wall finishes)			Ceramic tiles, metal trimming natural stone & engineered timber flooring	Gypsum board false ceiling with emulsion paint	Acrylic solid surface
			Kitchen	Wall finished with wall tiles (except areas covered by hanging kitchen cabinets, areas above the false ceiling level and areas covered by bulkhead at which there are no wall finishes) (except the following residential units)			Ceramic tiles (except the following residential units)	Aluminium false ceiling and aluminium louver (except the following residential units)	Acrylic solid surface (except the following residential units)
		Tower		Unit	Wall	Floor	Ceiling	Cooking Bench	
		Tower 1		49/F	A, B & C	Wall finished with natural stone (except area covered by hanging kitchen cabinets, area above the false ceiling level and areas covered by bulkhead at which there are no wall finishes)	Natural stone	Gypsum board false ceiling finished with emulsion paint and aluminium louver	Natural Stone
		Tower 2		49/F	A & B				
		Tower 3	50/F & 51/F	A & B (Duplex Unit)					
Tower 5	50/F & 51/F	A & B (Duplex Unit)							
(ii) Whether the wall finishes run up to the ceiling		Wall finishes run up to the false ceiling							

2. 室內裝修物料

細項		描述							
		牆壁			地板	天花板	灶台		
(e)	廚房	(i) 裝修物料的类型	開放式廚房	牆身鋪砌塑料層壓板、複合石及瓷磚 (但不包括掛廚櫃牆身、假天花以上及裝飾橫樑遮蓋的位置、該處之牆身不設裝修物料。)			瓷磚、金屬條、天然石及複合木地板	石膏板假天花髹乳膠漆	人造石
			廚房	牆身鋪砌瓷磚 (但不包括掛廚櫃牆身、假天花以上及裝飾橫樑遮蓋的位置、該處之牆身不設裝修物料。)(除以下住宅單位)			瓷磚 (除以下住宅單位)	鋁質假天花及鋁質百葉 (除以下住宅單位)	人造石 (除以下住宅單位)
		座數		單位	牆壁	地板	天花板	灶台	
		第1座		49樓	A、B及C	牆身鋪砌天然石 (但不包括掛廚櫃牆身、假天花以上及裝飾橫樑遮蓋的位置、該處之牆身不設裝修物料。)	天然石	石膏板假天花髹乳膠漆及鋁質百葉	天然石
		第2座		49樓	A及B				
		第3座	50樓及51樓	A及B (複式單位)					
第5座	50樓及51樓	A及B (複式單位)							
(ii) 牆壁的裝修物料是否鋪至天花板		牆壁的裝修物料鋪至假天花							

Note: 4/F, 13/F, 14/F, 24/F, 34/F and 44/F are omitted. 25/F is refuge floor.

備註：不設4樓、13樓、14樓、24樓、34樓及44樓。25樓為庇護層。

3. INTERIOR FITTINGS

		Material	Finishes	Accessories			
(a)	Doors	Main entrance door	Fire rated solid core timber door	Plastic laminate	Lockset, eye viewer, concealed door closer, security chain, concealed door hinges, door bottom seal and door stopper		
		Balcony door (sliding door)	Aluminium frame sliding door with tinted low-e coating tempered glass	Aluminium frame with fluorocarbon coating	Door handle, lockset, sliding door track and door stopper		
		Balcony door (swing door)	Aluminium frame swing door with tinted low-e coating tempered glass	Aluminium frame with fluorocarbon coating	Door handle, door hinges, lockset and door stopper		
		Utility platform door	Aluminium frame swing door with tinted low-e coating tempered glass	Aluminium frame with fluorocarbon coating	Door handle, door hinges and lockset, except the Utility platform door of the following residential units fitted with door handle, door hinges, door closer and lockset.		
					Tower		Unit
					Tower 1	6/F - 12/F, 15/F - 23/F, 26/F - 33/F, 35/F - 43/F & 45/F - 48/F	A, G & H
					Tower 2	6/F - 12/F, 15/F - 23/F, 26/F - 33/F, 35/F - 43/F & 45/F - 48/F	C, D, E, F & G
Tower 3	6/F - 12/F, 15/F - 23/F, 26/F - 33/F, 35/F - 43/F & 45/F - 49/F	A, B & D					
	5/F - 12/F, 15/F - 23/F, 26/F - 33/F, 35/F - 43/F & 45/F - 49/F	C					
Tower 5	6/F - 12/F, 15/F - 23/F, 26/F - 33/F, 35/F - 43/F & 45/F - 49/F	A, B & J					
	5/F - 12/F, 15/F - 23/F, 26/F - 33/F, 35/F - 43/F & 45/F - 49/F	C & D					

Note: 4/F, 13/F, 14/F, 24/F, 34/F and 44/F are omitted. 25/F is refuge floor.

3. 室內裝置

		用料	裝修物料	配件		
(a)	門	單位大門	防火實心木門	膠板	門鎖, 防盜眼、暗藏門鼓、防盜鏈、暗藏門鉸、門底密封條及門擋	
		露台趟門	鋁質框趟門鑲有色低輻射鍍膜強化玻璃	氟碳塗層鋁框	門把手、門鎖、趟門軌道套裝及門擋	
		露台掩門	鋁質框掩門鑲有色低輻射鍍膜強化玻璃	氟碳塗層鋁框	門把手、門鉸、門鎖及門擋	
		工作平台門	鋁質框掩門鑲有色低輻射鍍膜強化玻璃	氟碳塗層鋁框	門把手、門鉸及門鎖。除以下住宅單位之工作平台門裝設門把手、門鉸、門鼓及門鎖	
					座數	單位
					第1座	6樓-12樓、15樓-23樓、26樓-33樓、35樓-43樓及45樓-48樓 A、G及H
					第2座	6樓-12樓、15樓-23樓、26樓-33樓、35樓-43樓及45樓-48樓 C、D、E、F及G
					第3座	6樓-12樓、15樓-23樓、26樓-33樓、35樓-43樓及45樓-49樓 A、B及D
						5樓-12樓、15樓-23樓、26樓-33樓、35樓-43樓及45樓-49樓 C
					第5座	6樓-12樓、15樓-23樓、26樓-33樓、35樓-43樓及45樓-49樓 A、B及J
				5樓-12樓、15樓-23樓、26樓-33樓、35樓-43樓及45樓-49樓 C及D		

備註：不設4樓、13樓、14樓、24樓、34樓及44樓。25樓為庇護層。

3. INTERIOR FITTINGS

		Material	Finishes	Accessories				
(a)	Doors	Flat roof door (sliding door)	Aluminium frame sliding door with tinted low-e coating tempered glass	Aluminium frame with fluorocarbon coating	Door handle, lockset, sliding track set and door stopper.			
		Flat roof door (swing door)	Aluminium frame swing door with tinted low-e coating tempered glass	Aluminium frame with fluorocarbon coating	Door handle, door hinges and lockset, except the Flat roof door of the following residential units fitted with door handle, lockset, door hinges, door stopper and door closer.			
					Tower		Unit	Location
					Tower 1	5/F	A	Living room & Master bedroom
							H	Living room
					Tower 2	5/F	C & D	Master bedroom
							E	Living room
							F	Living room & Master bedroom
					Tower 3	5/F	G	Bedroom 1
		A & B	Living room					
Tower 5	5/F	D	Master bedroom					
		A & B	Living room					
		C	Bedroom 2					
Tower 5	5/F	J	Master bedroom					
		Door handle, door hinges and lockset: Unit D and E, 49/F, Tower 2						
Master bedroom door/ Bedroom door	Timber hollow core door	Plastic laminate	Lockset, door hinges and door stopper					
Master bathroom door/ Bathroom door	Timber hollow core door	Plastic laminate	Timber louver, lockset, door hinges and door stopper, except the Bathroom door of the following residential units finished with:-					
			(i) lockset, door stopper and sliding door track					
	Tower		Unit					
	Tower 2	5/F - 12/F, 15/F - 23/F, 26/F - 33/F, 35/F - 43/F & 45/F - 48/F	A					
(ii) lockset, door hinges and door stopper		Tower		Unit				
Tower 2	5/F - 12/F, 15/F - 23/F, 26/F - 33/F, 35/F - 43/F & 45/F - 48/F	E						
Metal frames with colour tempered glass	Metal frame with coating	Lockset, door stopper and sliding door track						
		Tower		Unit				
Tower 1	5/F - 12/F, 15/F - 23/F, 26/F - 33/F, 35/F - 43/F & 45/F - 48/F	F						
Kitchen door	Fire-rated solid core timber swing door with fire-rated glass panel	Plastic laminate	Lockset, door hinges, door bottom seal, door stopper and concealed door closer					

Note: 4/F, 13/F, 14/F, 24/F, 34/F and 44/F are omitted. 25/F is refuge floor.

3. 室內裝置

		用料	裝修物料	配件					
(a)	門	平台趟門	鋁質框趟門鑲有色低輻射鍍膜強化玻璃	氟碳塗層鋁框	門把手、門鎖、趟門軌道套裝及門擋				
		平台掩門	鋁質框掩門鑲有色低輻射鍍膜強化玻璃	氟碳塗層鋁框	門把手、門鎖及門鎖。除以下住宅單位之平台門裝設門把手、門鎖、門鎖、門鎖及門鎖				
					座數		單位		
					第1座	5樓	A		客廳及主人睡房
							H		客廳
					第2座	5樓	C及D		主人睡房
							E		客廳
							F		客廳及主人睡房
					第3座	5樓	G		睡房1
							A及B		客廳
					第5座	5樓	D		主人睡房
		A及B		客廳					
防火金屬掩門	油漆	門把手、門鎖及門鎖：第2座49樓D及E單位							
主人睡房門/睡房門	中空木門	塑料層壓板	門鎖、門鎖及門鎖						
主人浴室門/浴室門	中空木門	塑料層壓板	所有主人浴室門/浴室門配木百葉、門鎖、門鎖及門鎖。						
			除以下單位浴室門:-						
			(i) 門鎖、門鎖及趟門軌道套裝						
			座數		單位				
			第2座	5樓 - 12樓、15樓 - 23樓、26樓 - 33樓、35樓 - 43樓及45樓 - 48樓	A				
主人浴室門/浴室門	金屬框趟門鑲有色強化玻璃	塗層金屬框	(ii) 門鎖、門鎖及門鎖						
			座數		單位				
			第2座	5樓 - 12樓、15樓 - 23樓、26樓 - 33樓、35樓 - 43樓及45樓 - 48樓	E				
廚房門	防火實心木掩門及防火玻璃	塑料層壓板	門鎖、門鎖及趟門軌道套裝						
			座數		單位				
第1座	5樓 - 12樓、15樓 - 23樓、26樓 - 33樓、35樓 - 43樓及45樓 - 48樓	F							

備註：不設4樓、13樓、14樓、24樓、34樓及44樓。25樓為庇護層。

3. INTERIOR FITTINGS

			Material	Finishes	Accessories		
(a)	Doors	Utility room door	Timber hollow core door	Plastic laminate	Lockset, door hinges and door stopper, except the following residential units fitted with lockset and sliding door track.		
					Tower		Unit
					Tower 1	5/F - 12/F, 15/F - 23/F, 26/F - 33/F, 35/F - 43/F & 45/F - 48/F	H
					Tower 2	5/F - 12/F, 15/F - 23/F, 26/F - 33/F, 35/F - 43/F & 45/F - 48/F	F & G
					Tower 3	5/F - 12/F, 15/F - 23/F, 26/F - 33/F, 35/F - 43/F & 45/F - 49/F	H & J
						50/F - 51/F	F
		Tower 5	5/F - 12/F, 15/F - 23/F, 26/F - 33/F, 35/F - 43/F & 45/F - 49/F	J			
			50/F - 51/F	F			
		Fire rated solid core timber door	Lockset and sliding door track				
			Tower		Unit		
			Tower 1	49/F	B		
			Tower 3 & 5	5/F - 12/F, 15/F - 23/F, 26/F - 33/F, 35/F - 43/F & 45/F - 49/F	C		
50/F	B (Duplex Unit)						
Roof door	Aluminium frame swing door with tempered glass	Aluminium frame with fluorocarbon coating	Door handle, door hinges and lockset for the following residential units i) Unit A, B & C, 49/F, Tower 1 ii) Unit A & B, 49/F, Tower 2 iii) Unit A & B, 51/F, Tower 3 & Tower 5 (Duplex Unit)				
Store room door	Timber hollow core door	Plastic laminate	Door hinge				
Lavatory door/ Lavatory 1 door/ Lavatory 2 door	Folding door : Aluminum frame folding door Swing door : Timber hollow core door	Folding door : Frosted glass Swing door : Plastic laminate	Folding door: Door track set and lockset Swing door : Door hinges and lockset				

Note: 4/F, 13/F, 14/F, 24/F, 34/F and 44/F are omitted. 25/F is refuge floor.

3. 室內裝置

		用料	裝修物料	配件			
(a)	門	工作間門	中空木門	塑料層壓板	門鎖、門鉸及門擋。除以下住宅物業之門裝設門鎖及趟門軌道套裝		
					座數		單位
					第1座	5樓 - 12樓、15樓 - 23樓、26樓 - 33樓、 35樓 - 43樓及45樓 - 48樓	H
					第2座	5樓 - 12樓、15樓 - 23樓、26樓 - 33樓、 35樓 - 43樓及45樓 - 48樓	F及G
					第3座	5樓 - 12樓、15樓 - 23樓、26樓 - 33樓、 35樓 - 43樓及45樓 - 49樓	H及J
						50樓及51樓	F
					第5座	5樓 - 12樓、15樓 - 23樓、26樓 - 33樓、 35樓 - 43樓及45樓 - 49樓	J
						50樓及51樓	F
					門鎖及趟門軌道套裝		
					座數		單位
第1座	49樓	B					
第3座及 第5座	5樓 - 12樓、15樓 - 23樓、26樓 - 33樓、 35樓 - 43樓及45樓 - 49樓	C					
	50樓	B (複式單位)					
	天台門	鋁質框掩門鑲強化玻璃	氟碳塗層鋁框	門把手、門鉸及門鎖、適用於以下住宅單位 i) 第1座49樓A、B及C單位 ii) 第2座49樓A及B單位 iii) 第3座及第5座51樓A及B單位 (複式單位)			
	儲物室門	中空木門	塑料層壓板	門鉸			
	洗手間門/洗手間1門/ 洗手間2門	摺疊門：鋁框摺疊門 掩門：中空木門	摺疊門：磨砂玻璃 掩門：塑料層壓板	摺疊門：門軌道套裝及門鎖 掩門：門鉸及門鎖			

備註：不設4樓、13樓、14樓、24樓、34樓及44樓。25樓為庇護層。

3. INTERIOR FITTINGS

		Fitting & Equipment	Type	Material			
(b)	Master bathroom/ Bathroom	(i) Type and material of fittings and equipment	Countertop	Natural stone			
			Cabinet	Cabinet	Glass and mirror cabinet except the following master bathroom with glass and mirror cabinet with stainless steel frame		
					Tower		Unit
					Tower 1	49/F	A, B & C
					Tower 2	5/F - 12/F, 15/F - 23/F, 26/F - 33/F, 35/F - 43/F & 45/F - 48/F	C
						49/F	A & B
					Tower 3	5/F - 12/F, 15/F - 23/F, 26/F - 33/F, 35/F - 43/F & 45/F - 49/F	C & H
			50/F - 51/F	A & B (Duplex Unit), C & E			
			Tower 5	5/F - 12/F, 15/F - 23/F, 26/F - 33/F, 35/F - 43/F & 45/F - 49/F	C		
				50/F - 51/F	A & B (Duplex Unit) & E		
		Bathroom fittings	Water closet	Vitreous china			
			Wash basin	Vitreous china			
			Basin mixer	Chrome plated			
			Toilet paper holder	Chrome plated with glass			
			Towel hook	Chrome plated			
			Towel ring	Chrome plated			
			Towel bar	Chrome plated			
			Shower compartment	Tempered glass			
			Bathtub curtain track (only for bathtub)	Plastic & Aluminium			
		Bathroom appliance	For the appliances provision and brand name, please refer to the "Appliances Schedule "				
(ii) Type and material of water supply system	Cold water supply	Copper water pipes					
	Hot water supply	Copper water pipes with thermal insulation					
(iii) Type and material of bathing facilities (including shower or bathtub, if applicable)	Shower	Shower set	Chrome plated				
	Bathtub	Bathtub set	Chrome plated				
(iv) Size of bathtub, if applicable		Size: 1500 (L) x 700 (W) x 390 (H) mm	Enamelled steel				

Note: 4/F, 13/F, 14/F, 24/F, 34/F and 44/F are omitted. 25/F is refuge floor.

3. 室內裝置

		裝置及設備	類型	用料		
(b)	主人浴室/浴室	(i) 裝置及設備的類型及用料	櫃檯面	天然石		
			櫃	玻璃鏡櫃除以下主人浴室裝設玻璃鏡櫃及不銹鋼架		
				座數	單位	
				第1座	49樓	A、B及C
				第2座	5樓 - 12樓、15樓 - 23樓、 26樓 - 33樓、35樓 - 43樓及 45樓 - 48樓	C
					49樓	A及B
				第3座	5樓 - 12樓、15樓 - 23樓、 26樓 - 33樓、35樓 - 43樓及 45樓 - 49樓	C及H
					50樓-51樓	A及B（複式 單位）、C及E
				第5座	5樓 - 12樓、15樓 - 23樓、 26樓 - 33樓、35樓 - 43樓及 45樓 - 49樓	C
					50樓-51樓	A及B（複式 單位）及E
				浴室裝置	坐廁	搪瓷
		洗手盆	搪瓷			
		水龍頭	鍍鉻			
		廁紙架	鍍鉻及玻璃			
		毛巾掛鈎	鍍鉻			
		毛巾環	鍍鉻			
		毛巾棍	鍍鉻			
		淋浴間	強化玻璃			
		浴缸簾導軌（只用於浴缸）	塑料及鋁料			
		浴室設備	隨樓附送的設備及品牌，請參閱「設備說明表」			
		(ii) 供水系統的類型及用料	冷水供應	銅喉		
			熱水供應	隔熱絕緣保護之銅喉		
		(iii) 沐浴設施（包括花灑或浴缸（如適用的話））	花灑	淋浴套裝	鍍鉻	
浴缸	浴缸套裝		鍍鉻			
(iv) 浴缸大小（如適用的話）		尺寸：1500（長）x 700（闊）x 390（高） 毫米	搪瓷鋼			

備註：不設4樓、13樓、14樓、24樓、34樓及44樓。25樓為庇護層。

3. INTERIOR FITTINGS

			Material				
(c)	Kitchen	(i) Sink unit	Stainless steel				
		(ii) Water supply system	Copper water pipes for cold water supply and copper water pipes with thermal insulation for hot water supply				
		(iii) Kitchen cabinet	Wooden cabinet	Material		Finishes	
				Open kitchen: Melamine faced, except the finishes of the following units with melamine faced and medium-density fiberboard door panels finished with high gloss lacquer paint			
				Tower		Unit	
				Tower 1	5/F - 12/F, 15/F - 23/F, 26/F - 33/F, 35/F - 43/F & 45/F - 48/F		B, C & F
				Tower 2	5/F - 12/F, 15/F - 23/F, 26/F - 33/F, 35/F - 43/F & 45/F - 48/F		A, E & H
				Tower 3 & Tower 5	5/F - 12/F, 15/F - 23/F, 26/F - 33/F, 35/F - 43/F & 45/F - 49/F		E, F & G
		50/F - 51/F			D		
		Kitchen: Lacquer paint & melamine faced					
(iv) Type of all other fittings and equipment	Other fittings	Chrome plated sink mixer					
	Other equipment	Sprinkler head(s) and sounder-base smoke detector(s) installed in all units with open kitchen For the provision of appliances' brands and names, please refer to the "Appliances Schedule"					
			Fittings	Type	Material		
(d)	Master bedroom/ Bedroom	Type and material of fittings (including built-in wardrobe)	Not applicable	Not applicable	Not applicable		
(e)	Telephone	Location and number of connection points	Please refer to the "Schedule for Location and Number of Mechanical and Electrical Provisions of Residential Units".				
(f)	Aerials	Location and number of connection points	Please refer to the "Schedule for Location and Number of Mechanical and Electrical Provisions of Residential Units".				

Note: 4/F, 13/F, 14/F, 24/F, 34/F and 44/F are omitted. 25/F is refuge floor.

3. 室內裝置

		用料				
(c)	廚房	(i) 洗滌盆	不銹鋼			
		(ii) 供水系統	冷水喉採用銅喉及熱水喉採用配有隔熱絕緣保護之銅喉			
			用料	裝修物料		
		(iii) 廚櫃	木製廚櫃	開放式廚房：三聚氰胺貼面，除以下住宅單位的物料為三聚氰胺貼面及高光度油漆飾面中級密度纖維門板		
					座數	單位
				第1座	5樓 - 12樓、15樓 - 23樓、26樓 - 33樓、35樓 - 43樓及45樓 - 48樓	B、C及F
				第2座	5樓 - 12樓、15樓 - 23樓、26樓 - 33樓、35樓 - 43樓及45樓 - 48樓	A、E及H
				第3座及第5座	5樓 - 12樓、15樓 - 23樓、26樓 - 33樓、35樓 - 43樓及45樓 - 49樓	E、F及G
		50樓-51樓	D			
				廚房：焗漆及三聚氰胺貼面		
(iv) 所有其他裝置及設備的類型	其他裝置的類型	鍍鉻冷熱水龍頭				
	其他設備的類型	消防花灑頭及配置聲響警報基座煙霧探測器安裝於開放式廚房的單位 隨樓附送之設備及品牌，請參閱「設備說明表」				
		裝置	類型	用料		
(d)	主人睡房/睡房	裝置（包括嵌入式衣櫃）的類型及用料	不適用	不適用	不適用	
(e)	電話	接駁點的位置及數目	請參考「住宅單位機電裝置位置及數量說明表」			
(f)	天線	接駁點的位置及數目	請參考「住宅單位機電裝置位置及數量說明表」			

備註：不設4樓、13樓、14樓、24樓、34樓及44樓。25樓為庇護層。

3. INTERIOR FITTINGS

Item		Description				
(g)	Electrical installations	(i) Electrical fittings (including safety devices)	Electrical fittings	Faceplate for all switches and power sockets		
			Safety devices	(a) Single-phase electricity supply with miniature circuit breaker distribution board is provided for the following units:		
				Tower	Floor	Unit
				1 & 2	5/F - 12/F, 15/F-23/F, 26/F-33/F, 35/F-43/F & 45/F-48/F	A, B, C, D, E, F, G & H
				3 & 5	5/F - 12/F, 15/F-23/F, 26/F-33/F, 35/F-43/F & 45/F-49/F	A, B, C, D, E, F, G, H & J
				3 & 5	50/F & 51/F	C, D, E & F
				(b) Three-phase electricity (supply with miniature circuit breaker distribution board) is provided for the following units:		
				Tower	Floor	Unit
				1	49/F	A, B & C
				2	49/F	A & B
3 & 5	50/F & 51/F	A & B (Duplex Unit)				
	(ii) Whether conduits are concealed or exposed	Conduits are partly concealed and partly exposed* *Remarks: Other than those parts of the conduits concealed within concrete, the rest of them are exposed. The exposed conduits may be covered or hidden by false ceilings, bulkheads, cabinets, claddings, non-concrete partition walls, designated pipe ducts or other materials.				
	(iii) Location and number of power points and air-conditioner points	Please refer to the "Schedule for Location and Number of Mechanical and Electrical Provisions of Residential Units".				
Item		Description				
(h)	Gas supply	Type	Town gas			
		System	Gas piping is provided and connected to gas water heater and gas hob			
		Location	Please refer to the "Appliances Schedule"			
(i)	Washing machine connection point	Location	Please refer to the "Schedule for Location and Number of Mechanical and Electrical Provisions of Residential Units".			
		Design	Drain point and water point are provided for washer dryer			
(j)	Water supply	(i) Material of water pipes	Copper water pipes are provided for cold water supply. Copper water pipes with thermal insulation are provided for hot water supply.			
		(ii) Whether water pipes are concealed or exposed	Water pipes are partly concealed and partly exposed* *Remarks: Other than those parts of the water pipes concealed within concrete, the rest of them are exposed. The exposed water pipes may be covered or hidden by false ceilings, bulkheads, cabinets, claddings, non-concrete partition walls, designated pipe ducts or other materials.			
		(iii) Whether hot water is available	Hot water supply to Open kitchen, Kitchen, Master bathroom, Bathroom and Lavatory			

Note: 4/F, 13/F, 14/F, 24/F, 34/F and 44/F are omitted. 25/F is refuge floor.

3. 室內裝置

細項		描述				
(g)	電力裝置	(i) 供電附件 (包括安全裝置)	供電附件	提供開關掣及插座之面板		
			安全裝置	(a) 單相電力並裝妥微型斷路器提供於以下單位:		
				座數	樓層	單位
				1 及 2	5樓 - 12樓、15樓-23樓、26樓-33樓、35樓-43樓 及 45樓-48樓	A、B、C、D、E、F、G 及H
				3 及 5	5樓 - 12樓、15樓-23樓、26樓-33樓、35樓-43樓 及 45樓-49樓	A、B、C、D、E、F、G、H及J
				3 及 5	50樓 及 51樓	C、D、E及F
				(b) 三相電力並裝妥微型斷路器提供於以下單位:		
				座數	樓層	單位
				1	49樓	A、B及C
				2	49樓	A及B
3 及 5	50樓及51樓	A及B (複式單位)				
(ii) 導管是隱藏或外露	導管是部分隱藏及部分外露* *備註：除部分隱藏於混凝土內之導管外，其他部分的導管均為外露。外露的導管可能被假天花、假陣、貯存櫃、覆面、非混凝土間牆、指定之槽位或其他物料遮蓋。					
(iii) 電插座及空調機接駁點的位置及數目	請參閱「住宅單位機電裝置位置及數量說明表」					
細項		描述				
(h)	氣體供應	類型	煤氣			
		系統	煤氣喉接駁至煤氣熱水爐及煤氣煮食爐			
		位置	煤氣接駁點的位置請參閱「設備說明表」			
(i)	洗衣機接駁點	位置	請參閱「住宅單位機電裝置位置及數量說明表」			
		設計	洗衣乾衣機設有來去水設計			
(j)	供水	(i) 水管的用料	冷水喉採用銅喉及熱水喉採用配有隔熱絕緣保護之銅喉			
		(ii) 水管是隱藏或外露	水管是部分隱藏及部分外露* *備註：除部分隱藏於混凝土內之水管外，其他部分的水管均為外露。外露的水管可能被假天花、假陣、貯存櫃、覆面、非混凝土間牆、指定之槽位或其他物料遮蓋。			
		(iii) 有否熱水供應	開放式廚房、廚房、主人浴室、浴室及洗手間有熱水供應			

備註：不設4樓、13樓、14樓、24樓、34樓及44樓。25樓為庇護層。

4. MISCELLANEOUS

Item		Description		
(a)	Lifts	Residential Lifts	(i) Brand name and model number	Brand Name HITACHI
				Model Number HCA-900-CO240
			(ii) Number and Floors served by the lifts	Number of Lifts 16
				Tower Floor served by the lift
				<p>Tower 1</p> <ul style="list-style-type: none"> - 1 no. of passenger lift (L2): P/F, 5/F - 12/F, 15/F - 23/F, 25/F - 33/F, 35/F-43/F & 45/F - 49/F (Except 4/F, 13/F, 14/F, 24/F, 34/F & 44/F) - 3 no. of passenger lifts (L1, L3 & L4): P/F, 5/F - 12/F, 15/F - 23/F, 26/F - 33/F, 35/F - 43/F & 45/F - 49/F (Except 4/F, 13/F, 14/F, 24/F, 25/F, 34/F & 44/F) <p>Tower 2</p> <ul style="list-style-type: none"> - 1 no. of passenger lift (L1): P/F, 5/F - 12/F, 15/F - 23/F, 25/F - 33/F, 35/F - 43/F & 45/F - 49/F (Except 4/F, 13/F, 14/F, 24/F, 34/F & 44/F) - 3 no. of passenger lifts (L2, L3 & L4): P/F, 5/F - 12/F, 15/F - 23/F, 26/F - 33/F, 35/F - 43/F & 45/F - 49/F (Except 4/F, 13/F, 14/F, 24/F, 25/F, 34/F & 44/F) <p>Tower 3</p> <ul style="list-style-type: none"> - 1 no. of passenger lift (L3): 1/F - 2/F, P/F, 5/F - 12/F, 15/F - 23/F, 25/F - 33/F, 35/F - 43/F & 45/F - 51/F (Except 4/F, 13/F, 14/F, 24/F, 34/F & 44/F) - 3 no. of passenger lifts (L1, L2 & L4): 1/F, P/F, 5/F - 12/F, 15/F - 23/F, 26/F - 33/F, 35/F - 43/F & 45/F - 51/F (Except 2/F, 4/F, 13/F, 14/F, 24/F, 25/F, 34/F & 44/F) <p>Tower 5</p> <ul style="list-style-type: none"> - 1 no. of passenger lift (L1): 1/F - 2/F, P/F, 5/F - 12/F, 15/F - 23/F, 25/F - 33/F, 35/F - 43/F & 45/F - 51/F (Except 4/F, 13/F, 14/F, 24/F, 34/F & 44/F) - 3 no. of passenger lifts (L2, L3 & L4): 1/F, P/F, 5/F - 12/F, 15/F - 23/F, 26/F - 33/F, 35/F - 43/F & 45/F - 51/F (Except 2/F, 4/F, 13/F, 14/F, 24/F, 25/F, 34/F & 44/F)

The Vendor undertakes that if lifts of the specified brand name or model number are not installed in the Development, lifts of comparable quality will be installed.

Note: 4/F, 13/F, 14/F, 24/F, 34/F and 44/F are omitted. 25/F is refuge floor.

4. 雜項

細項		描述		
(a)	升降機	住宅升降機	(i) 品牌名稱及產品型號	品牌名稱 日立
				產品型號 HCA-900-CO240
			(ii) 升降機的數目及到達的樓層	升降機的數目 16
				升降機到達的樓層
				<p>第1座</p> <ul style="list-style-type: none"> 1部乘客升降機 (L2) : 基座平台、5樓-12樓、15樓-23樓、25樓-33樓、35樓-43樓及45樓-49樓 (除4樓、13樓、14樓、24樓、34樓及44樓) 3部乘客升降機 (L1、L3及L4) : 基座平台、5樓-12樓、15樓-23樓、26樓-33樓、35樓-43樓及45樓-49樓 (除4樓、13樓、14樓、24樓、25樓、34樓及44樓) <p>第2座</p> <ul style="list-style-type: none"> 1部乘客升降機 (L1) : 基座平台、5樓-12樓、15樓-23樓、25樓-33樓、35樓-43樓及45樓-49樓 (除4樓、13樓、14樓、24樓、34樓及44樓) 3部乘客升降機 (L2、L3及L4) : 基座平台、5樓-12樓、15樓-23樓、26樓-33樓、35樓-43樓及45樓-49樓 (除4樓、13樓、14樓、24樓、25樓、34樓及44樓) <p>第3座</p> <ul style="list-style-type: none"> 1部乘客升降機 (L3) : 1樓-2樓、基座平台、5樓-12樓、15樓-23樓、25樓-33樓、35樓-43樓及45樓-51樓 (除4樓、13樓、14樓、24樓、34樓及44樓) 3部乘客升降機 (L1、L2及L4) : 1樓、基座平台、5樓-12樓、15樓-23樓、26樓-33樓、35樓-43樓及45樓-51樓 (除2樓、4樓、13樓、14樓、24樓、25樓、34樓及44樓) <p>第5座</p> <ul style="list-style-type: none"> 1部乘客升降機 (L1) : 1樓-2樓、基座平台、5樓-12樓、15樓-23樓、25樓-33樓、35樓-43樓及45樓-51樓 (除4樓、13樓、14樓、24樓、34樓及44樓) 3部乘客升降機 (L2、L3及L4) : 1樓、基座平台、5樓-12樓、15樓-23樓、26樓-33樓、35樓-43樓及45樓-51樓 (除2樓、4樓、13樓、14樓、24樓、25樓、34樓及44樓)

賣方承諾如發展項目中沒有安裝指明的品牌名稱或產品型號的升降機，便會安裝品質相若的升降機。

備註：不設4樓、13樓、14樓、24樓、34樓及44樓。25樓為庇護層。

4. MISCELLANEOUS

Item		Description			
(a)	Lifts	Residential Lifts	(i) Brand name and model number	Brand Name	HITACHI
				Model Number	LCA-900-C060
			(ii) Number and floors served by them	Number of Lift(s)	1
				Floor served by the lift(s)	2/F & P/F
			(i) Brand name and model number	Brand Name	HITACHI
				Model Number	LCA-900-C0105
			(ii) Number and floors served by them	Number of Lift(s)	2
				Floor served by the lift(s)	B/F, G/F, 1/F, 2/F & P/F
			(i) Brand name and model number	Brand Name	HITACHI
				Model Number	LCA-2000-C0105
			(ii) Number and floors served by them	Number of Lift(s)	3
				Floor served by the lift(s)	B/F, G/F & P/F

4. 雜項

細項		描述			
(a)	升降機	住宅升降機	(i) 品牌名稱及產品型號	品牌名稱	日立
				產品型號	LCA-900-C060
			(ii) 升降機的數目及到達的樓層	升降機的數目	1
				到達的樓層	2樓及基座平台
			(i) 品牌名稱及產品型號	品牌名稱	日立
				產品型號	LCA-900-C0105
			(ii) 升降機的數目及到達的樓層	升降機的數目	2
				到達的樓層	地庫、地下、1樓、2樓及基座平台
			(i) 品牌名稱及產品型號	品牌名稱	日立
				產品型號	LCA-2000-C0105
			(ii) 升降機的數目及到達的樓層	升降機的數目	3
				到達的樓層	地庫、地下及基座平台

The Vendor undertakes that if lifts of the specified brand name or model number are not installed in the Development, lifts of comparable quality will be installed.

Note: 4/F, 13/F, 14/F, 24/F, 34/F and 44/F are omitted. 25/F is refuge floor.

賣方承諾如發展項目中沒有安裝指明的品牌名稱或產品型號的升降機，便會安裝品質相若的升降機。

備註：不設4樓、13樓、14樓、24樓、34樓及44樓。25樓為庇護層。

4. MISCELLANEOUS

Item		Description				
(b)	Letter box	Material	Metal			
(c)	Refuse Collection	Refuse storage & material recovery room is provided for storage of refuse at the common area of each residential floor. The refuse is collected and transported by cleaners to the central refuse storage and material recovery chamber provided on G/F for removal.				
				Water meter	Electricity meter	Gas meter
(d)	Water meter, electricity meter and gas meter	(i) Location	Tower 1 & Tower 2	Typical floor unit: Inside Water Meter Cabinet at respective residential floor; 49/F unit : Inside Water Meter Cabinet at roof floor;	Inside Electrical Meter Room/ Electrical Meter Cabinet at respective residential floor	Inside Kitchen/ Balcony/ Utility platform/ Flat roof/ Store room at respective unit
			Tower 3 & Tower 5	Inside water meter cabinet at respective residential floor	Inside Electrical Meter Room/ Electrical Meter Cabinet at respective residential floor	Inside Kitchen/ Balcony/ Utility platform/ Flat roof at respective unit
		(ii) Whether they are separate or communal meters for residential properties	Separate Meter	Separate Meter	Separate Meter	

4. 雜項

細項		描述				
(b)	信箱	用料	金屬			
(c)	垃圾收集	每層住宅樓層的公用地方設有垃圾及物料回收室，貯存垃圾，並由清潔工人收集及運送到地下之垃圾及物料回收房、處理及運走。				
(d)	水錶、電錶及氣體錶	(i) 位置		水錶	電錶	氣體錶
			第1及2座	標準層單位： 每層之水錶櫃 49層單位： 天台層之水錶櫃	各自住宅樓層之電錶房/電錶櫃	設於單位的廚房/露台/ 工作平台/平台/ 儲物室
			第3及5座	每層之公共水錶櫃內	各自住宅樓層之電錶房/電錶櫃	設於單位的廚房/露台/ 工作平台/平台
		(ii) 就住宅單位而言是獨立抑或公用的錶	獨立錶	獨立錶	獨立錶	

Note: 4/F, 13/F, 14/F, 24/F, 34/F and 44/F are omitted. 25/F is refuge floor.

備註：不設4樓、13樓、14樓、24樓、34樓及44樓。25樓為庇護層。

5. SECURITY FACILITIES

Item	Description	
Security system and equipment (including details of built-in provisions and their locations)	Access control and security system	<p>Each residential unit is equipped with a video door phone system and connected to caretaker counter at the P/F of respective entrance lobbies. (Please refer to the "Appliances Schedule" for location of video door phone in residential unit)</p> <p>Smart card readers are installed at each lift lobby of residential entrance at P/F</p> <p>Carpark control system is provided. Carpark barrier gate is provided at G/F vehicle entrance</p>
	CCTV	CCTV cameras are provided at main entrance lobbies, lifts and common area and connected to the management office

6. APPLIANCES

Brand name and model number	Please refer to "Appliances Schedule"

The Vendor undertakes that if lifts or appliances of the specified brand name or model number are not installed in the Development, lifts or appliances of comparable quality will be installed.

5. 保安設施

細項	描述	
保安系統及設備（包括嵌入式的裝修的細節及其位置）	入口通道控制及保安系統	<p>每戶單位設有門口視像對講機並連接各大廈位於基座平台入口大堂服務員櫃台。（有關住宅單位視像對講機位置，請參閱「設備說明表」）</p> <p>基座平台住宅大樓之入口升降機大堂均設有智能卡系統</p> <p>設有停車場管理系統，車閘設於地下車輛入口</p>
	閉路電視	閉路電視設於主要入口大堂、升降機內及公用空間並連接至管理處

6. 設備

品牌名稱及產品型號	請參閱「設備說明表」

賣方承諾如發展項目中沒有安裝指明的品牌名稱或產品型號的升降機或設備，便會安裝品質相若的升降機或設備。

APPLIANCES SCHEDULE - AIR CONDITIONING 設備說明表 - 空調

Tower 1 第1座															
Location 位置	Appliance 設備	Brand Name 品牌名稱	Model Number 產品型號	5/F, 6/F-12/F, 15/F-23/F, 26/F-33/F, 35/F-43/F, 45/F-48/F 5樓, 6樓-12樓, 15樓-23樓, 26樓-33樓, 35樓-43樓, 45樓-48樓								49/F 49樓			
				A	B	C	D	E	F	G	H	A	B	C	
Living Room & Dining Room / Master Bedroom / Bedroom 1 / Bedroom 2 / Utility Room (with Lavatory) 客廳及飯廳/ 主人睡房/睡房 1/睡房 2/ 睡房 3/工作間 (附設洗手間)	Split Type Air-Conditioner Indoor Unit 分體式冷暖機室內機	Daikin大金	FTXS35EVMA8	1	--	--	--	--	--	--	--	2	--	--	--
			FTXS71FVMA8	--	--	1	--	1	--	1	--	--	--	--	
	FTXS25LVMN		--	--	--	--	--	--	--	--	1	--	1		
	Split Type Air-Conditioner Outdoor Unit 分體式冷暖機室外機		RXS35EBVMA	1	--	--	--	--	--	--	2	--	--	--	
			RXS71FVMA	--	--	1	--	1	--	1	--	--	--	--	
			RXS25LVMN	--	--	--	--	--	--	--	--	1	--	1	
	Multiple Split Type Air-Conditioner Indoor Unit 多聯分體式冷暖機室內機	Daikin大金	FTXS25EVMA	2	--	--	--	1	--	1	1	--	--	--	
			FTXS35EVMA	2	1	--	--	1	1	1	1	--	--	--	
			FTXS50FVMA	--	1	--	--	--	1	--	--	--	--	--	
			FTXS25KVMN	--	--	--	--	--	--	--	--	3	3	2	
			FTXS35KVMN	--	--	--	--	--	--	--	--	1	1	--	
			Multiple Split Type Air-Conditioner Outdoor Unit 多聯分體式冷暖機室外機	2MXS50FV1B	--	--	--	--	--	--	--	--	1	1	1
				3MXS68EVMA	2	--	--	--	1	--	1	1	--	--	--
				3MXS68LVMA9	--	--	--	--	--	--	--	--	1	1	--
	4MXS100AA	--		1	--	--	--	1	--	--	--	--	--		
	VRV Type Air-Conditioner Indoor Unit 多聯變頻式空調系統室內機	Daikin大金	FXDP36QPVC	--	--	--	--	--	--	--	--	3	3	3	
			FXAQ25AVM	--	--	--	1	--	--	--	--	1	1		
			FXAQ32AVM	--	--	--	1	--	--	--	--	--	--	--	
			FXAQ63AVM	--	--	--	1	--	--	--	--	--	--	--	
		VRV Type Air-Conditioner Outdoor Unit 多聯變頻式空調系統室外機		RJZQ5AAV	--	--	--	1	--	--	--	--	1	1	1

Notes:

1. "1, 2," denotes the quantity of such provision(s) provided in the residential property.
2. The symbol "--" denotes "Not provided".
3. The Vendor undertakes that if lifts or appliances of the specified brand name or model number are not installed in the Development, lifts or appliances of comparable quality will be installed.
4. 4/F, 13/F, 14/F, 24/F, 34/F and 44/F are omitted. 25/F is refuge floor.

備註:

1. "1, 2," 表示提供於該住宅物業內的裝置數量。
2. 「--」代表「不提供」。
3. 賣方承諾如發展項目中沒有安裝指明的品牌名稱或產品型號的升降機或設備，便會安裝品質相若的升降機或設備。
4. 不設4樓、13樓、14樓、24樓、34樓及44樓。25樓為庇護層。

APPLIANCES SCHEDULE 設備說明表

Location 位置	Appliance 設備	Brand Name 品牌名稱	Model Number (if any) 產品型號 (如有)	Tower 1 第1座										
				Floor 樓層										
				5/F-12/F, 15/F-23/F, 26/F-33/F, 35/F-43/F, 45/F-48/F 5樓-12樓, 15樓-23樓, 26樓-33樓, 35樓-43樓, 45樓-48樓								49/F 49樓		
				Unit 單位										
				A	B	C	D	E	F	G	H	A	B	C
Open Kitchen 開放式廚房	Built-in Refrigerator ⁵ 嵌入式雪櫃 ⁵	De Dietrich	DRS 2022 J	--	√	√	--	--	√	--	--	--	--	--
			DRP 1905 JE	--	--	--	√	√	--	--	--	--	--	--
	Induction Hob 電磁爐	Miele	CS 1212-1i	--	√	√	--	--	√	--	--	--	--	--
			KM 7201 FR	--	--	--	√	√	--	--	--	--	--	--
	Microwave Combination Oven 微波焗爐	Miele	H 7440 BMX	--	--	--	√	√	--	--	--	--	--	--
	Cooker Hood 抽油煙機	Miele	DA 3466 HP	--	√	√	√	√	√	--	--	--	--	--
	Washer Dryer ⁶ 洗衣乾衣機 ⁶	De Dietrich	DLZ 8285 U	--	√	√	√	√	√	--	--	--	--	--
Steam Oven ⁷ 蒸爐 ⁷	Miele	DG 6010	--	√	√	--	--	√	--	--	--	--	--	

Notes:

1. The symbol "√" as shown in the above table denotes "Provided".
2. The symbol "--" as shown in the above table denotes "Not provided".
3. The Vendor undertakes that if lifts or appliances of the specified brand name or model number are not installed in the Development, lifts or appliances of comparable quality will be installed.
4. 4/F, 13/F, 14/F, 24/F, 34/F and 44/F are omitted. 25/F is refuge floor.
5. Built-in Refrigerator are located near the main entrance door of unit B, C, E & F.
6. Washer Dryer are located near the main entrance door of unit B, C & E.
7. Steam Oven are located near the main entrance door of unit B, C & F.

備註:

1. 上表「√」代表「提供」。
2. 上表「--」代表「不提供」。
3. 賣方承諾如發展項目中沒有安裝指明的品牌名稱或產品型號的升降機或設備，便會安裝品質相若的升降機或設備。
4. 不設4樓、13樓、14樓、24樓、34樓及44樓。25樓為庇護層。
5. 嵌入式雪櫃安裝於B、C、E及F單位大門附近。
6. 洗衣乾衣機安裝於B、C及E單位大門附近。
7. 蒸爐安裝於B、C及F單位大門附近。

APPLIANCES SCHEDULE 設備說明表

Location 位置	Appliance 設備	Brand Name 品牌名稱	Model Number (if any) 產品型號 (如有)	Tower 1 第1座												
				Floor 樓層												
				5/F-12/F, 15/F-23/F, 26/F-33/F, 35/F-43/F, 45/F-48/F 5樓-12樓, 15樓-23樓, 26樓-33樓, 35樓-43樓, 45樓-48樓								49/F 49樓				
				Unit 單位												
				A	B	C	D	E	F	G	H	A	B	C		
Kitchen 廚房	Built-in Refrigerator 嵌入式雪櫃	De Dietrich	DRP 1905 JE	√	--	--	--	--	--	--	√	√	--	--	--	
		Miele	KFNS 37432 ID	--	--	--	--	--	--	--	--	--	--	--	--	√
	Refrigerator 雪櫃	Sub-Zero	ICBBI-36UFDID	--	--	--	--	--	--	--	--	--	√	√	--	
	Gas Hob 氣體煮食爐	Miele	CS 1018G	√	--	--	--	--	--	--	√	√	√	√	√	
	CombiSet-2-Burner Gas Hob 組合式雙頭氣體煮食爐		CS 1013-1	√	--	--	--	--	--	--	√	√	√	√	√	
	Steam Combination Oven 蒸焗爐	Miele	DGC 7440 X	√	--	--	--	--	--	--	√	√	√	√	√	
	Washer Dryer 洗衣乾衣機	De Dietrich	DLZ 8285 U	√	--	--	--	--	--	--	√	√	--	--	--	
		Miele	WTR 860 WPM	--	--	--	--	--	--	--	--	--	√	√	√	
	Wine Cellar 酒櫃	Vinvautz	VZ 07 SSUG	√	--	--	--	--	--	--	--	--	--	--	--	√
			VZ 43 SDUG	--	--	--	--	--	--	--	--	--	--	√	√	--
	CombiSet-Barbecue Grill 組合式燒烤爐	Miele	CS 1312 BG	--	--	--	--	--	--	--	--	--	--	√	√	--
	Cooker Hood 抽油煙機	Miele	DA 3496 HP	√	--	--	--	--	--	--	√	√	--	--	--	√
			DA 5328 W	--	--	--	--	--	--	--	--	--	--	√	√	--
Coffee Machine 咖啡機	Miele	CVA 7440	--	--	--	--	--	--	--	--	--	√	√	--		
Private Roof 私人天台	BBQ Burner 燒烤爐	Napoleon	LEX Built-in 4 Burner	--	--	--	--	--	--	--	--	--	√	√	√	

Notes:

1. The symbol "√" as shown in the above table denotes "Provided".
2. The symbol "--" as shown in the above table denotes "Not provided".
3. The Vendor undertakes that if lifts or appliances of the specified brand name or model number are not installed in the Development, lifts or appliances of comparable quality will be installed.
4. 4/F, 13/F, 14/F, 24/F, 34/F and 44/F are omitted. 25/F is refuge floor.

備註:

1. 上表「√」代表「提供」。
2. 上表「--」代表「不提供」。
3. 賣方承諾如發展項目中沒有安裝指明的品牌名稱或產品型號的升降機或設備，便會安裝品質相若的升降機或設備。
4. 不設4樓、13樓、14樓、24樓、34樓及44樓。25樓為底護層。

APPLIANCES SCHEDULE 設備說明表

Location 位置	Appliance 設備	Brand Name 品牌名稱	Model Number (if any) 產品型號 (如有)	Tower 1 第1座											
				Floor 樓層											
				5/F-12/F, 15/F-23/F, 26/F-33/F, 35/F-43/F, 45/F-48/F 5樓-12樓, 15樓-23樓, 26樓-33樓, 35樓-43樓, 45樓-48樓								49/F 49樓			
				Unit 單位											
				A	B	C	D	E	F	G	H	A	B	C	
Open Kitchen/ Kitchen 開放式廚房/廚房	Exhaust Fan 抽氣扇	Nicotra	DPT15-45H	√	--	--	--	--	--	--	√	√	√	√	√
	Gas Water Heater 煤氣熱水爐	TGC	TSTW160/220TFL/TFQL	√	--	--	--	--	--	--	√	√	√	√	√
Living Room/ Dining Room/ Corridor 客廳/飯廳/走廊	Video Door Phone 視像對講機	iNex	IN-P9-C315	√	√	√	√	√	√	√	√	√	√	√	√
	Smoke Detector with Sounder Base 聲響警報基座煙霧探測器	Notifier	FSP-851 B501BH-3	--	√	√	√	√	√	--	--	--	--	--	--
	Exhaust Fan 抽氣扇	Nicotra	DPT15-34H	--	--	--	--	--	--	√	--	--	--	--	--
Master Bathroom 主人浴室	Thermo Ventilator 浴室寶	Panasonic	FV-40BE2H	√	--	--	--	--	--	--	--	--	√	√	√
	Exhaust Fan 抽氣扇	Nicotra	DPT15-34H	√	--	--	--	--	--	--	--	--	√	√	√
	Smart Mirror 智能鏡	ShareTV	ST-1915	√	--	--	--	--	--	--	--	--	√	√	√
	Gas Water Heater 煤氣熱水爐	TGC	TSTW160/220TFL/TFQL	--	--	--	--	--	--	--	--	--	--	--	√
Bathroom 浴室	Thermo Ventilator 浴室寶	Panasonic	FV-40BE2H	√	√	√	√	√	√	√	√	√	--	√	--
	Exhaust Fan 抽氣扇	Nicotra	DPT15-34H	--	--	--	√	√	--	√	√	√	--	--	--
	Smart Mirror 智能鏡	ShareTV	ST-1915	--	√	√	√	√	√	√	√	√	--	--	--
Bathroom 1 浴室 1	Thermo Ventilator 浴室寶	Panasonic	FV-40BE2H	--	--	--	--	--	--	--	--	--	√	--	√
Bathroom 2 浴室 2	Exhaust Fan 抽氣扇	Nicotra	DPT15-34H	--	--	--	--	--	--	--	--	--	√	--	√

Notes:

1. The symbol "√" as shown in the above table denotes "Provided".
2. The symbol "--" as shown in the above table denotes "Not provided".
3. The Vendor undertakes that if lifts or appliances of the specified brand name or model number are not installed in the Development, lifts or appliances of comparable quality will be installed.
4. 4/F, 13/F, 14/F, 24/F, 34/F and 44/F are omitted. 25/F is refuge floor.

備註:

1. 上表「√」代表「提供」。
2. 上表「--」代表「不提供」。
3. 賣方承諾如發展項目中沒有安裝指明的品牌名稱或產品型號的升降機或設備，便會安裝品質相若的升降機或設備。
4. 不設4樓、13樓、14樓、24樓、34樓及44樓。25樓為底護層。

APPLIANCES SCHEDULE 設備說明表

Location 位置	Appliance 設備	Brand Name 品牌名稱	Model Number (if any) 產品型號 (如有)	Tower 1 第1座											
				Floor 樓層											
				5/F-12/F, 15/F-23/F, 26/F-33/F, 35/F-43/F, 45/F-48/F 5樓-12樓, 15樓-23樓, 26樓-33樓, 35樓-43樓, 45樓-48樓								49/F 49樓			
				Unit 單位											
				A	B	C	D	E	F	G	H	A	B	C	
Lavatory/Lavatory inside Utility Room 洗手間/工作間內之 洗手間	Exhaust Fan 抽氣扇	Nicotra	DPT15-34H	--	--	--	--	--	--	--	--	--	√	√	√
Balcony/Flat Roof 露台/平台	Gas Water Heater 煤氣熱水爐	TGC	RBOX16QL/R	--	√	√	√	√	√	--	--	--	--	--	--
Private Roof 私人天台	Gas Water Heater 煤氣熱水爐	TGC	TSTW160/220TFL/TFQL	--	--	--	--	--	--	--	--	--	--	√	--

Notes:

1. The symbol "√" as shown in the above table denotes "Provided".
2. The symbol "--" as shown in the above table denotes "Not provided".
3. The Vendor undertakes that if lifts or appliances of the specified brand name or model number are not installed in the Development, lifts or appliances of comparable quality will be installed.
4. 4/F, 13/F, 14/F, 24/F, 34/F and 44/F are omitted. 25/F is refuge floor.

備註:

1. 上表「√」代表「提供」。
2. 上表「--」代表「不提供」。
3. 賣方承諾如發展項目中沒有安裝指明的品牌名稱或產品型號的升降機或設備，便會安裝品質相若的升降機或設備。
4. 不設4樓、13樓、14樓、24樓、34樓及44樓。25樓為庇護層。

APPLIANCES SCHEDULE - AIR CONDITIONING 設備說明表 - 空調

Tower 2 第2座																									
Location 位置	Appliance 設備	Brand Name 品牌名稱	Model Number 產品型號	5/F 5樓								6/F-12/F, 15/F-23/F, 26/F-33/F, 35/F-43/F, 45/F-48/F 6樓-12樓, 15樓-23樓, 26樓-33樓, 35樓-43樓, 45樓-48樓								49/F 49樓					
				A	B	C	D	E	F	G	H	A	B	C	D	E	F	G	H	A	B				
Living Room & Dining Room / Master Bedroom / Bedroom 1 / Bedroom 2 / Bedroom 3 / Utility Room (with Lavatory) 客廳及飯廳/ 主人睡房/睡房 1/睡房 2/ 睡房 3/工作間 (附設洗手間)	Split Type Air-Conditioner Indoor Unit 分體式冷暖機室內機	Daikin大金	FTXS25EVMA8	--	--	--	--	--	--	--	--	--	--	--	--	1	--	--	1	--	--	--			
			FTXS35EVMA8	--	--	--	--	1	1	--	--	--	--	--	--	1	1	1	1	--	--	--	--		
			FTXS50FVMA8	--	--	--	--	1	--	--	1	--	--	--	--	1	--	--	1	--	--	--	--	--	
			FTXS71FVMA8	--	--	--	1	--	1	1	--	--	--	--	1	--	1	1	--	--	--	--	--	--	
			FTXS25LVMN	--	--	--	--	--	--	--	--	--	--	--	--	--	--	--	--	--	--	--	--	2	
			FTXS35LVMN	--	--	--	--	--	--	--	--	--	--	--	--	--	--	--	--	--	--	--	--	1	
	Split Type Air-Conditioner Outdoor Unit 分體式冷暖機室外機		RXS25EBVMA	--	--	--	--	--	--	--	--	--	--	--	--	1	--	--	1	--	--	--	--		
			RXS35EBVMA	--	--	--	--	1	1	--	--	--	--	--	--	1	1	1	1	--	--	--	--		
			RXS50FVMA	--	--	--	--	1	--	--	1	--	--	--	--	1	--	--	1	--	--	--	--		
			RXS71FVMA	--	--	--	1	--	1	1	--	--	--	--	1	--	1	1	--	--	--	--	--	--	
			RXS25LVMN	--	--	--	--	--	--	--	--	--	--	--	--	--	--	--	--	--	--	--	--	2	
			RXS35LVMN	--	--	--	--	--	--	--	--	--	--	--	--	--	--	--	--	--	--	--	--	1	
	Multiple Split Type Air-Conditioner Indoor Unit 多聯分體式冷暖機室內機	Daikin大金	FTXS25EVMA	--	--	3	1	--	2	1	--	--	--	3	--	--	2	--	--	--	--	--	--		
			FTXS35EVMA	1	--	3	1	--	--	1	--	1	--	3	--	--	--	--	--	--	--	--	--	--	
			FTXS50FVMA	1	--	--	--	--	--	--	--	1	--	--	--	--	--	--	--	--	--	--	--	--	
			FTXS25KVMN	--	--	--	--	--	--	--	--	--	--	--	--	--	--	--	--	--	--	2	1	--	
			FTXS35KVMN	--	--	--	--	--	--	--	--	--	--	--	--	--	--	--	--	--	--	2	1	--	
			2MXS50FV1B	--	--	--	--	--	1	--	--	--	--	--	--	--	--	1	--	--	--	--	--	--	
			3MXS68EVMA	--	--	3	1	--	--	1	--	--	--	--	3	--	--	--	--	--	--	--	--	--	
			3MXS68LVMA9	--	--	--	--	--	--	--	--	--	--	--	--	--	--	--	--	--	--	2	1	--	
	Multiple Split Type Air-Conditioner Outdoor Unit 多聯分體式冷暖機室外機		4MXS100AA	1	--	--	--	--	--	--	--	1	--	--	--	--	--	--	--	--	--	--	--		
			VRV Type Air-Conditioner Indoor Unit 多聯變頻式空調系統室內機	Daikin大金	FXDP36QPVC	--	--	--	--	--	--	--	--	--	--	--	--	--	--	--	--	--	3	3	
					FXAQ25AVM	--	1	--	--	--	--	--	--	--	1	--	--	--	--	--	--	--	1	--	--
					FXAQ32AVM	--	1	--	--	--	--	--	--	--	1	--	--	--	--	--	--	--	--	--	--
	FXAQ50AVM	--			1	--	--	--	--	--	--	--	1	--	--	--	--	--	--	--	--	--	--		
	VRV Type Air-Conditioner Outdoor Unit 多聯變頻式空調系統室外機	Daikin大金	RJZQ5AAV	--	1	--	--	--	--	--	--	--	1	--	--	--	--	--	--	1	1	--	--		

Notes:

- "1, 2," denotes the quantity of such provision(s) provided in the residential property.
- The symbol "--" denotes "Not provided".
- The Vendor undertakes that if lifts or appliances of the specified brand name or model number are not installed in the Development, lifts or appliances of comparable quality will be installed.
- 4/F, 13/F, 14/F, 24/F, 34/F and 44/F are omitted. 25/F is refuge floor.

備註:

- "1, 2," 表示提供於該住宅物業內的裝置數量。
- 「--」代表「不提供」。
- 賣方承諾如發展項目中沒有安裝指明的品牌名稱或產品型號的升降機或設備，便會安裝品質相若的升降機或設備。
- 不設4樓、13樓、14樓、24樓、34樓及44樓。25樓為庇護層。

APPLIANCES SCHEDULE 設備說明表

Location 位置	Appliance 設備	Brand Name 品牌名稱	Model Number (if any) 產品型號 (如有)	Tower 2 第2座										
				Floor 樓層										
				5/F-12/F, 15/F-23/F, 26/F-33/F, 35/F-43/F, 45/F-48/F 5樓-12樓, 15樓-23樓, 26樓-33樓, 35樓-43樓, 45樓-48樓								49/F 49樓		
				Unit 單位										
				A	B	C	D	E	F	G	H	A	B	
Open Kitchen 開放式廚房	Built-in Refrigerator ⁵ 嵌入式雪櫃 ⁵	De Dietrich	DRS 2022 J	√	--	--	--	√	--	--	√	--	--	
			DRP 1905 JE	--	√	--	--	--	--	--	--	--	--	--
	Induction Hob 電磁爐	Miele	CS 1212-1i	√	--	--	--	√	--	--	√	--	--	
			KM 7201 FR	--	√	--	--	--	--	--	--	--	--	--
	Microwave Combination Oven 微波焗爐	Miele	H 7440 BMX	--	√	--	--	--	--	--	--	--	--	--
	Cooker Hood 抽油煙機	Miele	DA 3466 HP	√	√	--	--	√	--	--	√	--	--	
	Washer Dryer ⁵ 洗衣乾衣機 ⁵	De Dietrich	DLZ 8285 U	√	√	--	--	√	--	--	√	--	--	
Steam Oven ⁵ 蒸爐 ⁵	Miele	DG 6010	√	--	--	--	√	--	--	√	--	--		

Notes:

1. The symbol "√" as shown in the above table denotes "Provided".
2. The symbol "--" as shown in the above table denotes "Not provided".
3. The Vendor undertakes that if lifts or appliances of the specified brand name or model number are not installed in the Development, lifts or appliances of comparable quality will be installed.
4. 4/F, 13/F, 14/F, 24/F, 34/F and 44/F are omitted. 25/F is refuge floor.
5. Built-in Refrigerator, Washer Dryer and Steam Oven are located near the main entrance door of unit H.

備註:

1. 上表「√」代表「提供」。
2. 上表「--」代表「不提供」。
3. 賣方承諾如發展項目中沒有安裝指明的品牌名稱或產品型號的升降機或設備，便會安裝品質相若的升降機或設備。
4. 不設4樓、13樓、14樓、24樓、34樓及44樓。25樓為庇護層。
5. 嵌入式雪櫃、洗衣乾衣機及蒸爐安裝於H單位大門附近。

APPLIANCES SCHEDULE 設備說明表

Location 位置	Appliance 設備	Brand Name 品牌名稱	Model Number (if any) 產品型號 (如有)	Tower 2 第2座										
				Floor 樓層										
				5/F-12/F, 15/F-23/F, 26/F-33/F, 35/F-43/F, 45/F-48/F 5樓-12樓, 15樓-23樓, 26樓-33樓, 35樓-43樓, 45樓-48樓								49/F 49樓		
				Unit 單位										
				A	B	C	D	E	F	G	H	A	B	
Kitchen 廚房	Built-in Refrigerator 嵌入式雪櫃	De Dietrich	DRP 1905 JE	--	--	√	√	--	√	√	--	--	--	
	Refrigerator 雪櫃	Miele	K 31222 Ui ⁵	--	--	--	--	--	--	--	--	--	√	--
		Sub-Zero	ICBBI-36UFDID	--	--	--	--	--	--	--	--	--	√	√
	Gas Hob 氣體煮食爐	Miele	CS 1018G	--	--	√	√	--	√	√	--	√	√	
	CombiSet-2-Burner Gas Hob 組合式雙頭氣體煮食爐		CS 1013-1	--	--	√	√	--	√	√	--	√	√	
	Steam Combination Oven 蒸焗爐	Miele	DGC 7440 X	--	--	√	√	--	√	√	--	√	√	
	Washer Dryer 洗衣乾衣機	De Dietrich	DLZ 8285 U	--	--	√	√	--	√	√	--	--	--	--
		Miele	WTR 860 WPM	--	--	--	--	--	--	--	--	--	√	√
	Wine Cellar 酒櫃	Vinvautz	VZ 07 SSUG	--	--	√	--	--	--	√	--	--	--	--
			VZ 43 SDUG ⁵	--	--	--	--	--	--	--	--	--	√	√
	CombiSet-Barbecue Grill 組合式燒烤爐	Miele	CS 1312 BG	--	--	--	--	--	--	--	--	--	√	√
Cooker Hood 抽油煙機	Miele	DA 3496 HP	--	--	√	√	--	--	√	√	--	--	--	
		DA 5328 W ⁵	--	--	--	--	--	--	--	--	--	--	√	√
Coffee Machine 咖啡機	Miele	CVA 7440	--	--	--	--	--	--	--	--	--	√	√	
Private Roof 私人天台	BBQ Burner 燒烤爐	Napoleon	LEX Built-in 4 Burner	--	--	--	--	--	--	--	--	--	√	√

Notes:

1. The symbol "√" as shown in the above table denotes "Provided".
2. The symbol "--" as shown in the above table denotes "Not provided".
3. The Vendor undertakes that if lifts or appliances of the specified brand name or model number are not installed in the Development, lifts or appliances of comparable quality will be installed.
4. 4/F, 13/F, 14/F, 24/F, 34/F and 44/F are omitted. 25/F is refuge floor.
5. Appliances are located in the pantry.

備註:

1. 上表「√」代表「提供」。
2. 上表「--」代表「不提供」。
3. 賣方承諾如發展項目中沒有安裝指明的品牌名稱或產品型號的升降機或設備，便會安裝品質相若的升降機或設備。
4. 不設4樓、13樓、14樓、24樓、34樓及44樓。25樓為庇護層。
5. 設備安裝在備餐間。

APPLIANCES SCHEDULE 設備說明表

Location 位置	Appliance 設備	Brand Name 品牌名稱	Model Number (if any) 產品型號 (如有)	Tower 2 第2座									
				Floor 樓層									
				5/F-12/F, 15/F-23/F, 26/F-33/F, 35/F-43/F, 45/F-48/F 5樓-12樓, 15樓-23樓, 26樓-33樓, 35樓-43樓, 45樓-48樓								49/F 49樓	
				Unit 單位									
				A	B	C	D	E	F	G	H	A	B
Open Kitchen/ Kitchen 開放式廚房/廚房	Exhaust Fan 抽氣扇	Nicotra	DPT15-45H	--	--	√	√	--	√	√	--	√	√
	Gas Water Heater 煤氣熱水爐	TGC	TSTW160/220TFL/TFQL	--	--	√	--	--	--	√	--	--	--
Living Room/ Dining Room/ Corridor 客廳/飯廳/走廊	Video Door Phone 視像對講機	iNex	IN-P9-C315	√	√	√	√	√	√	√	√	√	√
	Smoke Detector with Sounder Base 聲響警報基座煙霧探測器	Notifier	FSP-851 B501BH-3	√	√	--	--	√	--	--	√	--	--
Master Bathroom 主人浴室	Thermo Ventilator 浴室寶	Panasonic	FV-40BE2H	--	--	√	--	--	√	--	--	√	√
	Exhaust Fan 抽氣扇	Nicotra	DPT15-34H	--	--	√	--	--	√	--	--	√	√
	Smart Mirror 智能鏡	ShareTV	ST-1915	--	--	√	--	--	√	--	--	√	√
Bathroom 浴室	Thermo Ventilator 浴室寶	Panasonic	FV-40BE2H	√	√	√	√	√	√	√	√	--	--
	Exhaust Fan 抽氣扇	Nicotra	DPT15-34H	--	√	--	√	--	--	√	--	--	--
	Smart Mirror 智能鏡	ShareTV	ST-1915	√	√	--	√	√	--	√	√	--	--
Bathroom 1 浴室 1	Thermo Ventilator 浴室寶	Panasonic	FV-40BE2H	--	--	--	--	--	--	--	--	√	√

Notes:

1. The symbol "√" as shown in the above table denotes "Provided".
2. The symbol "--" as shown in the above table denotes "Not provided".
3. The Vendor undertakes that if lifts or appliances of the specified brand name or model number are not installed in the Development, lifts or appliances of comparable quality will be installed.
4. 4/F, 13/F, 14/F, 24/F, 34/F and 44/F are omitted. 25/F is refuge floor.

備註:

1. 上表「√」代表「提供」。
2. 上表「--」代表「不提供」。
3. 賣方承諾如發展項目中沒有安裝指明的品牌名稱或產品型號的升降機或設備，便會安裝品質相若的升降機或設備。
4. 不設4樓、13樓、14樓、24樓、34樓及44樓。25樓為庇護層。

APPLIANCES SCHEDULE 設備說明表

Location 位置	Appliance 設備	Brand Name 品牌名稱	Model Number (if any) 產品型號 (如有)	Tower 2 第2座										
				Floor 樓層										
				5/F-12/F, 15/F-23/F, 26/F-33/F, 35/F-43/F, 45/F-48/F 5樓-12樓, 15樓-23樓, 26樓-33樓, 35樓-43樓, 45樓-48樓								49/F 49樓		
				Unit 單位										
				A	B	C	D	E	F	G	H	A	B	
Bathroom 2 浴室 2	Exhaust Fan 抽氣扇	Nicotra	DPT15-34H	--	--	--	--	--	--	--	--	--	√	√
Bathroom 3 浴室 3	Exhaust Fan 抽氣扇	Nicotra	DPT15-34H	--	--	--	--	--	--	--	--	--	√	√
	Gas Water Heater 煤氣熱水爐	TGC	TSTW160/220TFL/TFQL	--	--	--	--	--	--	--	--	--	--	√
Lavatory inside Utility Room 工作間內之洗手間	Exhaust Fan 抽氣扇	Nicotra	DPT15-34H	--	--	√	--	--	--	--	--	--	√	√
Balcony/Flat Roof 露台/平台	Gas Water Heater 煤氣熱水爐	TGC	RBOX16QL/R	√	√	--	--	--	√	--	√	--	--	--
Utility Platform/ Flat Roof 工作平台/平台	Gas Water Heater 煤氣熱水爐	TGC	RBOX16QL/R	--	--	--	√	√	√	--	--	--	--	--
Private Roof 私人天台	Gas Water Heater 煤氣熱水爐	TGC	TSTW160/220TFL/TFQL	--	--	--	--	--	--	--	--	--	√	√
Store Room 儲物室	Gas Water Heater 煤氣熱水爐	TGC	TSTW160/220TFL/TFQL	--	--	--	--	--	--	--	--	--	√	--

Notes:

1. The symbol "√" as shown in the above table denotes "Provided".
2. The symbol "--" as shown in the above table denotes "Not provided".
3. The Vendor undertakes that if lifts or appliances of the specified brand name or model number are not installed in the Development, lifts or appliances of comparable quality will be installed.
4. 4/F, 13/F, 14/F, 24/F, 34/F and 44/F are omitted. 25/F is refuge floor.

備註:

1. 上表「√」代表「提供」。
2. 上表「--」代表「不提供」。
3. 賣方承諾如發展項目中沒有安裝指明的品牌名稱或產品型號的升降機或設備，便會安裝品質相若的升降機或設備。
4. 不設4樓、13樓、14樓、24樓、34樓及44樓。25樓為庇護層。

APPLIANCES SCHEDULE- AIR CONDITIONING 設備說明表 - 空調

Tower 3 第3座																						
Location 位置	Appliance 設備	Brand Name 品牌名稱	Model Number 產品型號	5/F 5樓								6/F-12/F, 15/F-23/F, 26/F-33/F, 35/F-43/F, 45/F-49/F 6樓-12樓, 15樓-23樓, 26樓-33樓, 35樓-43樓, 45樓-49樓										
				A	B	C	D	E	F	G	H	J	A	B	C	D	E	F	G	H	J	
Living Room & Dining Room / Master Bedroom / Bedroom 1 / Bedroom 2 / Utility Room (with Lavatory) 客廳及飯廳/主人睡房/睡房 1/睡房 2/工作間 (附設洗手間)	Split Type Air-Conditioner Indoor Unit 分體式冷暖機室內機	Daikin大金	FTXS35EVMA8	1	--	--	1	--	--	--	1	--	1	--	1	1	--	--	--	1	--	
			FTXS71FVMA8	1	1	--	--	--	--	--	1	1	1	--	--	--	--	--	--	--	1	--
	Split Type Air-Conditioner Outdoor Unit 分體式冷暖機室外機		RXS35EBVMA	1	--	--	1	--	--	--	1	--	1	--	1	1	--	--	--	--	1	--
			RXS71FVMA	1	1	--	--	--	--	--	--	1	1	1	--	--	--	--	--	--	--	1
	Multiple Split Type Air-Conditioner Indoor Unit 多聯分體式冷暖機室內機	Daikin大金	FTXS25EVMA	2	1	1	--	--	--	--	2	1	2	1	1	--	--	--	--	2	1	
			FTXS35EVMA	--	1	1	--	1	1	1	2	1	--	1	1	--	1	1	1	2	1	
			FTXS50FVMA	--	--	--	--	1	1	1	--	--	--	--	--	--	1	1	1	--	--	
			2MXS50FV1B	1	--	--	--	--	--	--	--	--	1	--	--	--	--	--	--	--	--	--
	Multiple Split Type Air-Conditioner Outdoor Unit 多聯分體式冷暖機室外機	Daikin大金	3MXS68EVMA	--	1	1	--	1	1	1	2	1	--	1	1	--	1	1	1	2	1	
			VRV Type Air-Conditioner Indoor Unit 多聯變頻式空調系統室內機	FXAQ25AVM	--	--	2	2	--	--	--	--	--	--	--	2	2	--	--	--	--	--
	FXAQ32AVM	--		--	2	2	--	--	--	--	--	--	--	1	2	--	--	--	--	--		
	VRV Type Air-Conditioner Outdoor Unit 多聯變頻式空調系統室外機	Daikin大金		RJZQ5AAV	--	--	1	1	--	--	--	--	--	--	1	1	--	--	--	--	--	

Notes:

- "1, 2," denotes the quantity of such provision(s) provided in the residential property.
- The symbol "--" denotes "Not provided".
- The Vendor undertakes that if lifts or appliances of the specified brand name or model number are not installed in the Development, lifts or appliances of comparable quality will be installed.
- 4/F, 13/F, 14/F, 24/F, 34/F and 44/F are omitted. 25/F is refuge floor

備註:

- "1, 2," 表示提供於該住宅物業內的裝置數量。
- 「--」代表「不提供」。
- 賣方承諾如發展項目中沒有安裝指明的品牌名稱或產品型號的升降機或設備，便會安裝品質相若的升降機或設備。
- 不設4樓、13樓、14樓、24樓、34樓及44樓。25樓為庇護層。

APPLIANCES SCHEDULE- AIR CONDITIONING 設備說明表 - 空調

Tower 3 第3座														
Location 位置	Appliance 設備	Brand Name 品牌名稱	Model Number 產品型號	50/F & 51/F (Duplex Unit) 50樓及51樓 (複式單位)		50/F 50樓				51/F 51樓				
				A	B	C	D	E	F	C	D	E	F	
Living Room & Dining Room / Master Bedroom / Bedroom 1 / Bedroom 2 / Bedroom 3 / Family Room / Utility Room (with Lavatory) 客廳及飯廳/ 主人睡房/睡房 1/睡房 2/ 睡房 3/家庭室/工作間 (附設洗手間)	Split Type Air-Conditioner Indoor Unit 分體式冷暖機室內機	Daikin大金	FDXS25CVMA	--	1	--	--	--	--	--	--	--	--	
			FDXS50CVMA	2	--	--	--	--	--	--	--	--	--	
			FTXS25LVMN	1	--	--	--	--	1	--	--	--	--	
			FTXS35LVMN	--	2	1	--	--	--	2	--	--	--	
			FTXS71LVMN	1	--	--	--	2	1	--	--	2	--	
			Split Type Air-Conditioner Outdoor Unit 分體式冷暖機室外機	RXS25EBVMA	--	1	--	--	--	--	--	--	--	--
				RXS25LVMN	1	--	--	--	--	1	--	--	--	
				RXS35LVMN	--	2	1	--	--	--	2	--	--	
	RXS50FVMA	2		--	--	--	--	--	--	--	--			
	Multiple Split Type Air-Conditioner Indoor Unit 多聯分體式冷暖機室內機	Daikin大金	FDXS35CVMA	--	1	--	--	--	--	--	--	--		
			FDXS50CVMA	1	--	--	--	--	--	--	--	--		
			FTXS25KVMN	--	3	--	--	4	1	2	--	4	2	
			FTXS35KVMN	5	--	--	1	1	1	2	1	1	1	
			FTXS50KAVMN	--	--	--	1	--	--	--	1	--	--	
			FTXS71KAVMN	--	--	--	--	--	--	--	--	--	1	
			Multiple Split Type Air-Conditioner Outdoor Unit 多聯分體式冷暖機室外機	2MXS50FV1B	--	1	--	--	1	--	--	--	1	--
				3MXS68LVMA9	2	1	--	1	2	1	2	1	2	1
	4MXS80LVMA9	1		--	--	--	--	--	--	--	--	--		
	4MXS100AA	--		--	--	--	--	--	--	--	--	1		
	VRV Type Air-Conditioner Indoor Unit 多聯變頻式空調系統室內機	Daikin大金	FXDP36QPVC	--	2	--	--	--	--	--	--	--		
			FXAQ25AVM	--	--	3	--	--	--	--	--	--		
			FXAQ32AVM	--	--	2	--	--	--	--	--	--		
	VRV Type Air-Conditioner Outdoor Unit 多聯變頻式空調系統室外機		RJZQ5AAV	--	1	1	--	--	--	--	--	--		

Notes:

- "1, 2," denotes the quantity of such provision(s) provided in the residential property.
- The symbol "--" denotes "Not provided".
- The Vendor undertakes that if lifts or appliances of the specified brand name or model number are not installed in the Development, lifts or appliances of comparable quality will be installed.
- 4/F, 13/F, 14/F, 24/F, 34/F and 44/F are omitted. 25/F is refuge floor.

備註:

- "1, 2," 表示提供於該住宅物業內的裝置數量。
- 「--」代表「不提供」。
- 賣方承諾如發展項目中沒有安裝指明的品牌名稱或產品型號的升降機或設備，便會安裝品質相若的升降機或設備。
- 不設4樓、13樓、14樓、24樓、34樓及44樓。25樓為庇護層。

APPLIANCES SCHEDULE 設備說明表

Tower 3 第3座																						
樓層 Floor																						
Location 位置	Appliance 設備	Brand Name 品牌名稱	Model Number (if any) 產品型號 (如有)	5/F-12/F, 15/F-23/F, 26/F-33/F, 35/F-43/F, 45/F-49/F 5樓-12樓, 15樓-23樓, 26樓-33樓, 35樓-43樓, 45樓-49樓										50/F & 51/F (Duplex Unit) 50樓及51樓 (複式單位)		50/F 50樓		51/F 51樓				
				單位 Unit																		
				A	B	C	D	E	F	G	H	J	A	B	C	D	E	F	C	D	E	F
Open Kitchen 開放式廚房	Built-in Refrigerator 嵌入式雪櫃	De Dietrich	DRS 2022 J	--	--	--	--	√	√	√	--	--	--	--	--	√	--	--	--	√	--	--
			DRP 1905 JE	--	√	--	--	--	--	--	--	--	--	--	--	--	--	--	--	--	--	--
	Induction Hob 電磁爐	Miele	CS 1212-1i	--	--	--	--	√	√	√	--	--	--	--	--	√	--	--	--	√	--	--
			KM 7201 FR	--	√	--	--	--	--	--	--	--	--	--	--	--	--	--	--	--	--	--
	Microwave Combination Oven 微波焗爐	Miele	H 7440 BMX	--	√	--	--	--	--	--	--	--	--	--	--	--	--	--	--	--	--	--
	Cooker Hood 抽油煙機	Miele	DA 3466 HP	--	√	--	--	√	√	√	--	--	--	--	--	√	--	--	--	√	--	--
	Washer Dryer 洗衣乾衣機	De Dietrich	DLZ 8285 U	--	√	--	--	√	√	√	--	--	--	--	--	√	--	--	--	√	--	--
	Steam Oven 蒸爐	Miele	DG 6010	--	--	--	--	√	√	√	--	--	--	--	--	√	--	--	--	√	--	--

Notes:

1. The symbol "√" as shown in the above table denotes "Provided".
2. The symbol "--" as shown in the above table denotes "Not provided".
3. The Vendor undertakes that if lifts or appliances of the specified brand name or model number are not installed in the Development, lifts or appliances of comparable quality will be installed.
4. 4/F, 13/F, 14/F, 24/F, 34/F and 44/F are omitted. 25/F is refuge floor.

備註:

1. 上表「√」代表「提供」。
2. 上表「--」代表「不提供」。
3. 賣方承諾如發展項目中沒有安裝指明的品牌名稱或產品型號的升降機或設備，便會安裝品質相若的升降機或設備。
4. 不設4樓、13樓、14樓、24樓、34樓及44樓。25樓為庇護層。

APPLIANCES SCHEDULE 設備說明表

				Tower 3 第3座																		
				樓層 Floor																		
Location 位置	Appliance 設備	Brand Name 品牌名稱	Model Number (if any) 產品型號 (如有)	5/F-12/F, 15/F-23/F, 26/F-33/F, 35/F-43/F, 45/F-49/F 5樓-12樓, 15樓-23樓, 26樓-33樓, 35樓-43樓, 45樓-49樓						50/F & 51/F (Duplex Unit) 50樓及51樓 (複式單位)		50/F 50樓				51/F 51樓						
				單位 Unit																		
				A	B	C	D	E	F	G	H	J	A	B	C	D	E	F	C	D	E	F
Kitchen 廚房	Built-in Refrigerator 嵌入式雪櫃	De Dietrich	DRP 1905 JE	√	--	--	√	--	--	--	√	√	--	--	√	--	√	√	√	--	√	√
	Refrigerator 雪櫃	Panasonic	NR-F654HX/X3	--	--	√	--	--	--	--	--	--	--	--	--	--	--	--	--	--	--	--
		Miele	K 31222 Ui ⁵	--	--	--	--	--	--	--	--	--	√	√	--	--	--	--	--	--	--	--
		Sub-Zero	ICBBI-36UFDID	--	--	--	--	--	--	--	--	--	√	√	--	--	--	--	--	--	--	--
	Gas Hob 氣體煮食爐	Miele	CS 1018G	√	--	√	√	--	--	--	√	√	√	√	√	--	√	√	√	--	√	√
	CombiSet-2-Burner Gas Hob 組合式雙頭氣體煮食爐		CS 1013-1	√	--	√	√	--	--	--	√	√	√	√	√	--	√	√	√	--	√	√
	Steam Combination Oven 蒸焗爐	Miele	DGC 7440 X	√	--	√	√	--	--	--	√	√	√	√	√	--	√	√	√	--	√	√
	Washer Dryer 洗衣乾衣機	De Dietrich	DLZ 8285 U	√	--	√	√	--	--	--	√	√	--	--	√	--	√	√	√	--	√	√
		Miele	WTR 86 WPM	--	--	--	--	--	--	--	--	--	√	√	--	--	--	--	--	--	--	--
	Wine Cellar 酒櫃	Vinvautz	VZ 07 SSUG	√	--	√	√	--	--	--	√	--	--	--	√	--	√	--	√	--	√	--
			VZ 43 SDUG ⁵	--	--	--	--	--	--	--	--	--	√	√	--	--	--	--	--	--	--	--
	CombiSet-Barbecue Grill 組合式燒烤爐	Miele	CS 1312 BG	--	--	--	--	--	--	--	--	--	√	√	--	--	--	--	--	--	--	--
	Cooker Hood 抽油煙機	Miele	DA 3496 HP	√	--	√	√	--	--	--	√	√	--	--	√	--	√	√	√	--	√	√
DA 5328 W			--	--	--	--	--	--	--	--	--	√	√	--	--	--	--	--	--	--	--	
Coffee Machine 咖啡機	Miele	CVA 7440 ⁵	--	--	--	--	--	--	--	--	--	√	√	--	--	--	--	--	--	--	--	
Private Roof 私人天台	BBQ Burner 燒烤爐	Napoleon	LEX Built-in 4 Burner	--	--	--	--	--	--	--	--	--	--	√	√	--	--	--	--	--	--	

Notes:

- The symbol "√" as shown in the above table denotes "Provided".
- The symbol "--" as shown in the above table denotes "Not provided".
- The Vendor undertakes that if lifts or appliances of the specified brand name or model number are not installed in the Development, lifts or appliances of comparable quality will be installed.
- 4/F, 13/F, 14/F, 24/F, 34/F and 44/F are omitted. 25/F is refuge floor.
- Appliances are located in the pantry.

備註:

- 上表「√」代表「提供」。
- 上表「--」代表「不提供」。
- 賣方承諾如發展項目中沒有安裝指明的品牌名稱或產品型號的升降機或設備，便會安裝品質相若的升降機或設備。
- 不設4樓、13樓、14樓、24樓、34樓及44樓。25樓為底護層。
- 設備安裝在備餐間。

APPLIANCES SCHEDULE 設備說明表

				Tower 3 第3座																			
				樓層 Floor																			
Location 位置	Appliance 設備	Brand Name 品牌名稱	Model Number (if any) 產品型號 (如有)	5/F-12/F, 15/F-23/F, 26/F-33/F, 35/F-43/F, 45/F-49/F 5樓-12樓, 15樓-23樓, 26樓-33樓, 35樓-43樓, 45樓-49樓										50/F & 51/F (Duplex Unit) 50樓及51樓 (複式單位)		50/F 50樓				51/F 51樓			
				單位 Unit																			
				A	B	C	D	E	F	G	H	J	A	B	C	D	E	F	C	D	E	F	
Open Kitchen/ Kitchen 開放式廚房/ 廚房	Exhaust Fan 抽氣扇	Nicotra	DPT15-45H	√	--	√	√	--	--	--	√	√	√	√	√	--	√	√	√	--	√	√	
	Gas Water Heater 煤氣熱水爐	TGC	TSTW160/220TFL/TFQL	√	--	√	--	--	--	--	√	√	√	√	--	--	√	√	--	--	√	√	
	Lavatory Exhaust Fan 洗手間抽氣扇	Nicotra	DPT15-34H	--	--	--	--	--	--	--	--	--	--	--	√	--	--	--	√	--	--	--	
Living Room/ Dining Room/ Corridor 客廳/飯廳/走廊	Video Door Phone 視像對講機	iNex	IN-P9-C315	√	√	√	√	√	√	√	√	√	√	√	√	√	√	√	√	√	√	√	
	Smoke Detector with Sounder Base 聲響警報基座 煙霧探測器	Notifier	FSP-851 B501BH-3	--	√	--	--	√	√	√	--	--	--	--	--	√	--	--	--	√	--	--	
Master Bathroom 主人浴室	Thermo Ventilator 浴室寶	Panasonic	FV-40BE2H	--	--	√	--	--	--	--	√	--	√	√	√	--	√	--	√	--	√	--	
	Exhaust Fan 抽氣扇	Nicotra	DPT15-34H	--	--	√	--	--	--	--	√	--	√	√	√	--	√	--	√	--	√	--	
	Smart Mirror 智能鏡	ShareTV	ST-1915	--	--	√	--	--	--	--	√	--	√	√	√	--	√	--	√	--	√	--	
	Gas Water Heater 煤氣熱水爐	TGC	TSTW160/220TFL/TFQL	--	--	--	--	--	--	--	--	--	√	--	--	--	--	--	--	--	--	--	
Bathroom 浴室	Thermo Ventilator 浴室寶	Panasonic	FV-40BE2H	√	√	√	√	√	√	√	√	√	--	--	√	√	√	√	√	√	√	√	
	Exhaust Fan 抽氣扇	Nicotra	DPT15-34H	√	--	--	√	--	--	--	--	√	--	--	--	--	√	√	--	--	√	√	
	Smart Mirror 智能鏡	ShareTV	ST-1915	√	√	--	√	√	√	√	--	√	--	--	--	√	--	√	--	√	--	√	
Bathroom 1 浴室 1	Exhaust Fan 抽氣扇	Nicotra	DPT15-34H	--	--	--	--	--	--	--	--	--	√	√	--	--	--	--	--	--	--	--	
	Thermo Ventilator 浴室寶	Panasonic	FV-40BE2H	--	--	--	--	--	--	--	--	--	√	--	--	--	--	--	--	--	--	--	

Notes:

- The symbol "√" as shown in the above table denotes "Provided".
- The symbol "--" as shown in the above table denotes "Not provided".
- The Vendor undertakes that if lifts or appliances of the specified brand name or model number are not installed in the Development, lifts or appliances of comparable quality will be installed.
- 4/F, 13/F, 14/F, 24/F, 34/F and 44/F are omitted. 25/F is refuge floor.

備註:

- 上表「√」代表「提供」。
- 上表「--」代表「不提供」。
- 賣方承諾如發展項目中沒有安裝指明的品牌名稱或產品型號的升降機或設備，便會安裝品質相若的升降機或設備。
- 不設4樓、13樓、14樓、24樓、34樓及44樓。25樓為庇護層。

APPLIANCES SCHEDULE 設備說明表

				Tower 3 第3座																			
				樓層 Floor																			
Location 位置	Appliance 設備	Brand Name 品牌名稱	Model Number (if any) 產品型號 (如有)	5/F-12/F, 15/F-23/F, 26/F-33/F, 35/F-43/F, 45/F-49/F 5樓-12樓, 15樓-23樓, 26樓-33樓, 35樓-43樓, 45樓-49樓										50/F & 51/F (Duplex Unit) 50樓及51樓 (複式單位)		50/F 50樓				51/F 51樓			
				單位 Unit																			
				A	B	C	D	E	F	G	H	J	A	B	C	D	E	F	C	D	E	F	
Bathroom 2 浴室 2	Exhaust Fan 抽氣扇	Nicotra	DPT15-34H	--	--	--	--	--	--	--	--	--	√	√	--	--	--	--	--	--	--	--	
	Gas Water Heater 煤氣熱水爐	TGC	TSTW160/220TFL/TFQL	--	--	--	--	--	--	--	--	--	√	--	--	--	--	--	--	--	--	--	
Bathroom 3 浴室 3	Thermo Ventilator 浴室寶	Panasonic	FV-40BE2H	--	--	--	--	--	--	--	--	--	--	√	--	--	--	--	--	--	--	--	
	Exhaust Fan 抽氣扇	Nicotra	DPT15-34H	--	--	--	--	--	--	--	--	--	√	√	--	--	--	--	--	--	--	--	
	Gas Water Heater 煤氣熱水爐	TGC	TSTW160/220TFL/TFQL	--	--	--	--	--	--	--	--	--	--	√	--	--	--	--	--	--	--	--	
Bathroom 4 浴室 4	Thermo Ventilator 浴室寶	Panasonic	FV-40BE2H	--	--	--	--	--	--	--	--	--	--	--	--	--	--	--	--	--	--	--	
	Exhaust Fan 抽氣扇	Nicotra	DPT15-34H	--	--	--	--	--	--	--	--	--	--	--	--	--	--	--	--	--	--	--	
Lavatory 1 洗手間 1	Exhaust Fan 抽氣扇	Nicotra	DPT15-34H	--	--	--	--	--	--	--	--	--	√	√	--	--	--	--	--	--	--	--	
Lavatory 2 洗手間 2	Exhaust Fan 抽氣扇	Nicotra	DPT15-34H	--	--	--	--	--	--	--	--	--	√	√	--	--	--	--	--	--	--	--	
Lavatory inside Utility Room 工作間內之 洗手間	Exhaust Fan 抽氣扇	Nicotra	DPT15-34H	--	--	√	--	--	--	--	--	--	--	--	--	--	√	--	--	--	√	--	
Balcony/ Flat Roof 露台/平台	Gas Water Heater 煤氣熱水爐	TGC	RBOX16QL/R	--	--	--	√	√	√	√	--	--	--	--	√	√	--	--	√	√	--	--	
Utility Platform/ Flat Roof 工作平台/平台	Gas Water Heater 煤氣熱水爐	TGC	RBOX16QL/R	--	√	--	--	--	--	--	--	--	--	--	--	--	--	--	--	--	--	--	
Private Roof 私人天台	Gas Water Heater 煤氣熱水爐	TGC	TSTW160/220TFL/TFQL	--	--	--	--	--	--	--	--	--	√	√	--	--	--	--	--	--	--	--	

Notes:

1. The symbol "√" as shown in the above table denotes "Provided".
2. The symbol "--" as shown in the above table denotes "Not provided".
3. The Vendor undertakes that if lifts or appliances of the specified brand name or model number are not installed in the Development, lifts or appliances of comparable quality will be installed.
4. 4/F, 13/F, 14/F, 24/F, 34/F and 44/F are omitted. 25/F is refuge floor.

備註:

1. 上表「√」代表「提供」。
2. 上表「--」代表「不提供」。
3. 賣方承諾如發展項目中沒有安裝指明的品牌名稱或產品型號的升降機或設備，便會安裝品質相若的升降機或設備。
4. 不設4樓、13樓、14樓、24樓、34樓及44樓。25樓為庇護層。

APPLIANCES SCHEDULE- AIR CONDITIONING 設備說明表 - 空調

Tower 5 第5座																							
Location 位置	Appliance 設備	Brand Name 品牌名稱	Model Number 產品型號	5/F 5樓										6/F-12/F, 15/F-23/F, 26/F-33/F, 35/F-43/F, 45/F-49/F 6樓-12樓, 15樓-23樓, 26樓-33樓, 35樓-43樓, 45樓-49樓									
				A	B	C	D	E	F	G	H	J	A	B	C	D	E	F	G	H	J		
Living Room & Dining Room / Master Bedroom / Bedroom 1 / Bedroom 2 / Utility Room (with Lavatory) 客廳及飯廳/主人睡房/睡房 1/睡房 2/工作間 (附設洗手間)	Split Type Air-Conditioner Indoor Unit 分體式冷暖機室內機	Daikin大金	FTXS35EVMA8	1	--	1	1	--	--	--	--	--	1	--	1	1	--	--	--	--	--		
			FTXS71FVMA8	1	1	--	--	--	--	--	1	1	1	1	--	--	--	--	--	1	1	--	
	Split Type Air-Conditioner Outdoor Unit 分體式冷暖機室外機		RXS35EBVMA	1	--	1	1	--	--	--	--	--	1	--	1	1	--	--	--	--	--	--	
			RXS71FVMA	1	1	--	--	--	--	--	1	1	1	1	--	--	--	--	--	1	1	--	
	Multiple Split Type Air-Conditioner Indoor Unit 多聯分體式冷暖機室內機	Daikin大金	FTXS25EVMA	2	1	1	--	--	--	--	1	1	2	1	1	--	--	--	--	1	1	--	
			FTXS35EVMA	--	1	1	--	1	1	1	1	1	--	1	1	--	1	1	1	1	1	1	--
			FTXS50FVMA	--	--	--	--	1	1	1	-	-	--	--	--	--	1	1	1	-	-	-	--
			2MXS50FV1B	1	--	--	--	--	--	--	--	--	1	--	--	--	--	--	--	--	--	--	--
	Multiple Split Type Air-Conditioner Outdoor Unit 多聯分體式冷暖機室外機	Daikin大金	3MXS68EVMA	--	1	1	-	1	1	1	1	1	--	1	1	-	1	1	1	1	1	1	
			VRV Type Air-Conditioner Indoor Unit 多聯變頻式空調系統室內機	FXAQ25AVM	--	--	2	2	--	--	--	--	--	--	--	2	2	--	--	--	--	--	--
FXAQ32AVM				--	--	1	2	--	--	--	--	--	--	--	1	2	--	--	--	--	--	--	--
VRV Type Air-Conditioner Outdoor Unit 多聯變頻式空調系統室外機	Daikin大金	RJZQ5AAV	--	--	1	1	--	--	--	--	--	--	--	1	1	--	--	--	--	--	--		

Notes:

- “1, 2, ……” denotes the quantity of such provision(s) provided in the residential property.
- The symbol “--” denotes “Not provided”.
- The Vendor undertakes that if lifts or appliances of the specified brand name or model number are not installed in the Development, lifts or appliances of comparable quality will be installed.
- 4/F, 13/F, 14/F, 24/F, 34/F and 44/F are omitted. 25/F is refuge floor

備註:

- “1, 2, ……” 表示提供於該住宅物業內的裝置數量。
- 「--」代表「不提供」。
- 賣方承諾如發展項目中沒有安裝指明的品牌名稱或產品型號的升降機或設備，便會安裝品質相若的升降機或設備。
- 不設4樓、13樓、14樓、24樓、34樓及44樓。25樓為庇護層。

APPLIANCES SCHEDULE- AIR CONDITIONING 設備說明表 - 空調

Tower 5 第5座														
Location 位置	Appliance 設備	Brand Name 品牌名稱	Model Number 產品型號	50/F & 51/F (Duplex Unit) 50樓及51樓 (複式單位)		50/F 50樓				51/F 51樓				
				A	B	C	D	E	F	C	D	E	F	
Living Room & Dining Room / Master Bedroom / Bedroom 1 / Bedroom 2 / Bedroom 3 / Family Room / Utility Room (with Lavatory) 客廳及飯廳/ 主人睡房/睡房 1/睡房 2/ 睡房 3/家庭室/工作間 (附設洗手間)	Split Type Air-Conditioner Indoor Unit 分體式冷暖機室內機	Daikin大金	FDXS25CVMA	--	1	--	--	--	--	--	--	--	--	
			FDXS50CVMA	2	--	--	--	--	--	--	--	--	--	
			FTXS25LVMN	1	--	--	--	--	1	--	--	--	--	
			FTXS35LVMN	--	2	1	--	--	--	1	--	--	--	
			FTXS50LVMN	--	--	--	--	1	--	--	--	1	--	
			FTXS71LVMN	1	--	--	--	--	1	--	--	--	--	
	Split Type Air-Conditioner Outdoor Unit 分體式冷暖機室外機		RXS25EBVMA	--	1	--	--	--	--	--	--	--	--	--
			RXS25LVMN	1	--	--	--	--	1	--	--	--	--	
			RXS35LVMN	--	2	1	--	--	--	1	--	--	--	
			RXS50FVMA	2	--	--	--	--	--	--	--	--	--	
			RXS50LVMN	--	--	--	--	1	--	--	--	1	--	
			RXS71LVMN	1	--	--	--	--	1	--	--	--	--	
	Multiple Split Type Air-Conditioner Indoor Unit 多聯分體式冷暖機室內機	Daikin大金	FDXS35CVMA	--	1	--	--	--	--	--	--	--	--	
			FDXS50CVMA	1	--	--	--	--	--	--	--	--	--	
			FTXS25KVMN	--	3	--	--	4	1	--	--	4	2	
			FTXS35KVMN	5	--	--	1	1	1	--	1	1	1	
			FTXS50KAVMN	--	--	--	1	1	--	--	1	1	--	
			FTXS71KAVMN	--	--	--	--	--	--	--	--	--	1	
			Multiple Split Type Air-Conditioner Outdoor Unit 多聯分體式冷暖機室外機	2MXS50FV1B	--	1	--	--	1	--	--	--	1	--
				3MXS68LVMA9	2	1	--	1	1	1	--	1	1	1
	4MXS80LVMA9			1	--	--	--	1	--	--	--	1	--	
	4MXS100AA			--	--	--	--	--	--	--	--	--	1	
	VRV Type Air-Conditioner Indoor Unit 多聯變頻式空調系統室內機		Daikin大金	FXDP36QPVC	--	2	--	--	--	--	--	--	--	--
				FXAQ25AVM	--	--	2	--	--	--	2	--	--	--
FXAQ32AVM		--		--	2	--	--	--	2	--	--	--		
VRV Type Air-Conditioner Outdoor Unit 多聯變頻式空調系統室外機		RJZQ5AAV		--	1	1	--	--	--	1	--	--	--	

Notes:

- "1, 2," denotes the quantity of such provision(s) provided in the residential property.
- The symbol "--" denotes "Not provided".
- The Vendor undertakes that if lifts or appliances of the specified brand name or model number are not installed in the Development, lifts or appliances of comparable quality will be installed.
- 4/F, 13/F, 14/F, 24/F, 34/F and 44/F are omitted. 25/F is refuge floor

備註:

- "1, 2," 表示提供於該住宅物業內的裝置數量。
- 「--」代表「不提供」。
- 賣方承諾如發展項目中沒有安裝指明的品牌名稱或產品型號的升降機或設備，便會安裝品質相若的升降機或設備。
- 不設4樓、13樓、14樓、24樓、34樓及44樓。25樓為庇護層。

APPLIANCES SCHEDULE 設備說明表

Location 位置	Appliance 設備	Brand Name 品牌名稱	Model Number (if any) 產品型號 (如有)	Tower 5 第5座																			
				Floor 樓層																			
				5/F-12/F, 15/F-23/F, 26/F-33/F, 35/F-43/F, 45/F-49/F 5樓-12樓, 15樓-23樓, 26樓-33樓, 35樓-43樓, 45樓-49樓										50/F & 51/F (Duplex Unit) 50樓及51樓 (複式單位)		50/F 50樓				51/F 51樓			
				單位 Unit																			
A	B	C	D	E	F	G	H	J	A	B	C	D	E	F	C	D	E	F	C	D	E	F	
Open Kitchen 開放式廚房	Built-in Refrigerator 嵌入式雪櫃	De Dietrich	DRS 2022 J	--	--	--	--	√	√	√	--	--	--	--	--	√	--	--	--	√	--	--	
			DRP 1905 JE	--	√	--	--	--	--	--	--	--	--	--	--	--	--	--	--	--	--	--	--
	Induction Hob 電磁爐	Miele	CS 1212-1i	--	--	--	--	√	√	√	--	--	--	--	√	--	--	--	√	--	--		
			KM 7201 FR	--	√	--	--	--	--	--	--	--	--	--	--	--	--	--	--	--	--	--	--
	Microwave Combination Oven 微波焗爐	Miele	H 7440 BMX	--	√	--	--	--	--	--	--	--	--	--	--	--	--	--	--	--	--	--	
	Cooker Hood 抽油煙機	Miele	DA 3466 HP	--	√	--	--	√	√	√	--	--	--	--	--	√	--	--	--	√	--	--	
	Washer Dryer 洗衣乾衣機	De Dietrich	DLZ 8285 U	--	√	--	--	√	√	√	--	--	--	--	--	√	--	--	--	√	--	--	
	Steam Oven 蒸焗爐	Miele	DG 6010	--	--	--	--	√	√	√	--	--	--	--	--	√	--	--	--	√	--	--	

Notes:

1. The symbol "√" as shown in the above table denotes "Provided".
2. The symbol "--" as shown in the above table denotes "Not provided".
3. The Vendor undertakes that if lifts or appliances of the specified brand name or model number are not installed in the Development, lifts or appliances of comparable quality will be installed.
4. 4/F, 13/F, 14/F, 24/F, 34/F and 44/F are omitted. 25/F is refuge floor.

備註:

1. 上表「√」代表「提供」。
2. 上表「--」代表「不提供」。
3. 賣方承諾如發展項目中沒有安裝指明的品牌名稱或產品型號的升降機或設備，便會安裝品質相若的升降機或設備。
4. 不設4樓、13樓、14樓、24樓、34樓及44樓。25樓為庇護層。

APPLIANCES SCHEDULE 設備說明表

				Tower 5 第5座																			
				Floor 樓層																			
Location 位置	Appliance 設備	Brand Name 品牌名稱	Model Number (if any) 產品型號 (如有)	5/F-12/F, 15/F-23/F, 26/F-33/F, 35/F-43/F, 45/F-49/F 5樓-12樓, 15樓-23樓, 26樓-33樓, 35樓-43樓, 45樓-49樓										50/F & 51/F (Duplex Unit) 50樓及51樓 (複式單位)		50/F 50樓				51/F 51樓			
				Unit Unit																			
				A	B	C	D	E	F	G	H	J	A	B	C	D	E	F	C	D	E	F	
Kitchen 廚房	Built-in Refrigerator 嵌入式雪櫃	De Dietrich	DRP 1905 JE	√	--	--	√	--	--	--	√	√	--	--	√	--	√	√	√	--	√	√	
	Refrigerator 雪櫃	Panasonic	NR-F654HX/X3	--	--	√	--	--	--	--	--	--	--	--	--	--	--	--	--	--	--	--	
		Miele	K 31222 Ui ⁵	--	--	--	--	--	--	--	--	--	√	√	--	--	--	--	--	--	--	--	
		Sub-Zero	ICBBI-36UFDID	--	--	--	--	--	--	--	--	--	√	√	--	--	--	--	--	--	--	--	
	Gas Hob 氣體煮食爐	Miele	CS 1018G	√	--	√	√	--	--	--	√	√	√	√	√	--	√	√	√	--	√	√	
	CombiSet-2-Burner Gas Hob 組合式雙頭氣體煮食爐		CS 1013-1	√	--	√	√	--	--	--	√	√	√	√	√	--	√	√	√	--	√	√	
	Steam Combination Oven 蒸焗爐	Miele	DGC 7440 X	√	--	√	√	--	--	--	√	√	√	√	√	--	√	√	√	--	√	√	
	Washer Dryer 洗衣乾衣機	De Dietrich	DLZ 8285 U	√	--	√	√	--	--	--	√	√	--	--	√	--	√	√	√	--	√	√	
		Miele	WTR 86 WPM	--	--	--	--	--	--	--	--	--	√	√	--	--	--	--	--	--	--	--	
	Wine Cellar 酒櫃	Vinvautz	VZ 07 SSUG	√	--	√	√	--	--	--	--	--	--	--	√	--	√	--	√	--	√	--	
			VZ 43 SDUG ⁵	--	--	--	--	--	--	--	--	--	√	√	--	--	--	--	--	--	--	--	
	CombiSet-Barbecue Grill 組合式燒烤爐	Miele	CS 1312 BG	--	--	--	--	--	--	--	--	--	√	√	--	--	--	--	--	--	--	--	
	Cooker Hood 抽油煙機	Miele	DA 3496 HP	√	--	√	√	--	--	--	√	√	--	--	√	--	√	√	√	--	√	√	
DA 5328 W			--	--	--	--	--	--	--	--	--	√	√	--	--	--	--	--	--	--	--		
Coffee Machine 咖啡機	Miele	CVA 7440 ⁵	--	--	--	--	--	--	--	--	--	√	√	--	--	--	--	--	--	--	--		
Private Roof 私人天台	BBQ Burner 燒烤爐	Napoleon	LEX Built-in 4 Burner	--	--	--	--	--	--	--	--	--	--	√	√	--	--	--	--	--	--		

Notes:

1. The symbol "√" as shown in the above table denotes "Provided".
2. The symbol "--" as shown in the above table denotes "Not provided".
3. The Vendor undertakes that if lifts or appliances of the specified brand name or model number are not installed in the Development, lifts or appliances of comparable quality will be installed.
4. 4/F, 13/F, 14/F, 24/F, 34/F and 44/F are omitted. 25/F is refuge floor.
5. Appliances are located in the pantry.

備註:

1. 上表「√」代表「提供」。
2. 上表「--」代表「不提供」。
3. 賣方承諾如發展項目中沒有安裝指明的品牌名稱或產品型號的升降機或設備，便會安裝品質相若的升降機或設備。
4. 不設4樓、13樓、14樓、24樓、34樓及44樓。25樓為庇護層。
5. 設備安裝在備餐間。

APPLIANCES SCHEDULE 設備說明表

				Tower 5 第5座																			
				Floor 樓層																			
Location 位置	Appliance 設備	Brand Name 品牌名稱	Model Number (if any) 產品型號 (如有)	5/F-12/F, 15/F-23/F, 26/F-33/F, 35/F-43/F, 45/F-49/F 5樓-12樓, 15樓-23樓, 26樓-33樓, 35樓-43樓, 45樓-49樓										50/F & 51/F (Duplex Unit) 50樓及51樓 (複式單位)		50/F 50樓				51/F 51樓			
				Unit Unit																			
				A	B	C	D	E	F	G	H	J	A	B	C	D	E	F	C	D	E	F	
Open Kitchen/ Kitchen 開放式廚房/ 廚房	Exhaust Fan 抽氣扇	Nicotra	DPT15-45H	√	--	√	√	--	--	--	√	√	√	√	√	--	√	√	√	--	√	√	
	Gas Water Heater 煤氣熱水爐	TGC	TSTW160/220TFL/TFQL	√	--	√	--	--	--	--	√	√	√	√	--	--	√	√	--	--	√	√	
Living Room/ Dining Room/ Corridor 客廳/飯廳/走廊	Video Door Phone 視像對講機	iNex	IN-P9-C315	√	√	√	√	√	√	√	√	√	√	√	√	√	√	√	√	√	√	√	
	Smoke Detector with Sounder Base 聲響警報基座 煙霧探測器	Notifier	FSP-851 B501BH-3	--	√	--	--	√	√	√	--	--	--	--	--	√	--	--	--	√	--	--	
Master Bathroom 主人浴室	Thermo Ventilator 浴室寶	Panasonic	FV-40BE2H	--	--	√	--	--	--	--	--	--	√	√	--	--	√	--	--	--	--	√	--
	Exhaust Fan 抽氣扇	Nicotra	DPT15-34H	--	--	√	--	--	--	--	--	--	√	√	--	--	√	--	--	--	--	√	--
	Smart Mirror 智能鏡	ShareTV	ST-1915	--	--	√	--	--	--	--	--	--	√	√	--	--	√	--	--	--	--	√	--
	Gas Water Heater 煤氣熱水爐	TGC	TSTW160/220TFL/TFQL	--	--	--	--	--	--	--	--	--	√	--	--	--	--	--	--	--	--	--	--
Bathroom 浴室	Thermo Ventilator 浴室寶	Panasonic	FV-40BE2H	√	√	√	√	√	√	√	√	√	--	--	√	√	√	√	√	√	√	√	√
	Exhaust Fan 抽氣扇	Nicotra	DPT15-34H	√	--	--	√	--	--	--	√	√	--	--	√	--	√	√	√	--	√	√	√
	Smart Mirror 智能鏡	ShareTV	ST-1915	√	√	--	√	√	√	√	√	√	--	--	√	√	--	√	√	√	√	√	--
Bathroom 1 浴室 1	Thermo Ventilator 浴室寶	Panasonic	FV-40BE2H	--	--	--	--	--	--	--	--	--	√	--	--	--	--	--	--	--	--	--	--
	Exhaust Fan 抽氣扇	Nicotra	DPT15-34H	--	--	--	--	--	--	--	--	--	√	√	--	--	--	--	--	--	--	--	--
	Gas Water Heater 煤氣熱水爐	TGC	TSTW160/220TFL/TFQL	--	--	--	--	--	--	--	--	--	--	--	--	--	--	--	--	--	--	--	--

Notes:

1. The symbol "√" as shown in the above table denotes "Provided".
2. The symbol "--" as shown in the above table denotes "Not provided".
3. The Vendor undertakes that if lifts or appliances of the specified brand name or model number are not installed in the Development, lifts or appliances of comparable quality will be installed.
4. 4/F, 13/F, 14/F, 24/F, 34/F and 44/F are omitted. 25/F is refuge floor.

備註:

1. 上表「√」代表「提供」。
2. 上表「--」代表「不提供」。
3. 賣方承諾如發展項目中沒有安裝指明的品牌名稱或產品型號的升降機或設備，便會安裝品質相若的升降機或設備。
4. 不設4樓、13樓、14樓、24樓、34樓及44樓。25樓為庇護層。

APPLIANCES SCHEDULE 設備說明表

				Tower 5 第5座																			
				Floor 樓層																			
Location 位置	Appliance 設備	Brand Name 品牌名稱	Model Number (if any) 產品型號 (如有)	5/F-12/F, 15/F-23/F, 26/F-33/F, 35/F-43/F, 45/F-49/F 5樓-12樓, 15樓-23樓, 26樓-33樓, 35樓-43樓, 45樓-49樓										50/F & 51/F (Duplex Unit) 50樓及51樓 (複式單位)		50/F 50樓				51/F 51樓			
				Unit Unit																			
				A	B	C	D	E	F	G	H	J	A	B	C	D	E	F	C	D	E	F	
Bathroom 2 浴室 2	Exhaust Fan 抽氣扇	Nicotra	DPT15-34H	--	--	--	--	--	--	--	--	--	√	√	--	--	--	--	--	--	--	--	
	Gas Water Heater 煤氣熱水爐	TGC	TSTW160/220TFL/TFQL	--	--	--	--	--	--	--	--	--	√	--	--	--	--	--	--	--	--	--	
Bathroom 3 浴室 3	Exhaust Fan 抽氣扇	Nicotra	DPT15-34H	--	--	--	--	--	--	--	--	--	√	√	--	--	--	--	--	--	--	--	
	Gas Water Heater 煤氣熱水爐	TGC	TSTW160/220TFL/TFQL	--	--	--	--	--	--	--	--	--	--	√	--	--	--	--	--	--	--	--	
	Thermo Ventilator 浴室寶	Panasonic	FV-40BE2H	--	--	--	--	--	--	--	--	--	--	√	--	--	--	--	--	--	--	--	
Lavatory 1 洗手間 1	Exhaust Fan 抽氣扇	Nicotra	DPT15-34H	--	--	--	--	--	--	--	--	--	√	√	--	--	--	--	--	--	--	--	
Lavatory 2 洗手間 2	Exhaust Fan 抽氣扇	Nicotra	DPT15-34H	--	--	--	--	--	--	--	--	--	√	√	--	--	--	--	--	--	--	--	
Lavatory inside Utility Room 工作間內之 洗手間	Exhaust Fan 抽氣扇	Nicotra	DPT15-34H	--	--	√	--	--	--	--	--	--	--	--	--	--	√	--	--	--	√	--	
Balcony/ Flat Roof 露台/平台	Gas Water Heater 煤氣熱水爐	TGC	RBOX16QL/R	--	--	--	√	√	√	√	--	--	--	--	√	√	--	--	√	√	--	--	
Utility Platform/ Flat Roof 工作平台/平台	Gas Water Heater 煤氣熱水爐	TGC	RBOX16QL/R	--	√	--	--	--	--	--	--	--	--	--	--	--	--	--	--	--	--	--	
Private Roof 私人天台	Gas Water Heater 煤氣熱水爐	TGC	TSTW160/220TFL/TFQL	--	--	--	--	--	--	--	--	--	√	√	--	--	--	--	--	--	--	--	

Notes:

1. The symbol "√" as shown in the above table denotes "Provided".
2. The symbol "--" as shown in the above table denotes "Not provided".
3. The Vendor undertakes that if lifts or appliances of the specified brand name or model number are not installed in the Development, lifts or appliances of comparable quality will be installed.
4. 4/F, 13/F, 14/F, 24/F, 34/F and 44/F are omitted. 25/F is refuge floor.

備註:

1. 上表「√」代表「提供」。
2. 上表「--」代表「不提供」。
3. 賣方承諾如發展項目中沒有安裝指明的品牌名稱或產品型號的升降機或設備，便會安裝品質相若的升降機或設備。
4. 不設4樓、13樓、14樓、24樓、34樓及44樓。25樓為庇護層。

SCHEDULE FOR LOCATION AND NUMBER OF MECHANICAL AND ELECTRICAL PROVISIONS OF RESIDENTIAL UNITS (TOWER 1) 住宅單位機電裝置位置及數量說明表 (第1座)

Location 位置	Description 描述	5/F 5樓								6/F-12/F, 15/F-23/F, 26/F-33/F, 35/F-43/F, 45/F-48/F 6樓-12樓, 15樓-23樓, 26樓-33樓, 35樓-43樓, 45樓-48樓								49/F 49樓				
		A	B	C	D	E	F	G	H	A	B	C	D	E	F	G	H	A	B	C		
Main Entrance 大門入口	Exposed Type 外露型	Door Bell Push Button 門鈴按鈕	1	1	1	1	1	1	1	1	1	1	1	1	1	1	1	1	1	1	1	
Living Room, Dining Room & Corridor 客廳、飯廳及 走廊	Exposed Type 外露型	Lighting Switch 燈掣	14	4	6	12	13	8	14	16	13	4	6	12	12	7	13	14	16	15	16	
		Lighting Point 燈位	6	3	3	5	5	3	6	6	6	3	3	5	5	3	6	6	22	21	23	
		Video Door Phone 門口視像對講機	1	1	1	1	1	1	1	1	1	1	1	1	1	1	1	1	1	1	1	1
		13A Twin Socket Outlet 13安培雙位電插座	3	4	3	3	3	4	3	3	3	3	4	3	3	3	4	3	3	3	3	3
		13A Single Socket Outlet 13安培單位電插座	--	--	1	--	--	--	--	--	--	--	--	1	--	--	--	--	4	4	5	
		Fused Spur Unit 菲士接線座	--	--	--	--	--	--	--	--	--	--	--	--	--	--	--	--	4	2	2	
		Switch for Curtain 窗簾開關掣	--	--	--	--	--	--	--	--	--	--	--	--	--	--	--	--	4	2	2	
		Switch for Air Conditioning Unit 冷氣機開關掣	2	1	1	--	1	1	1	2	2	2	1	1	--	1	1	1	2	--	--	--
		TV/FM Outlet 電視/電台天線插座	2	2	1	2	2	2	2	2	2	2	2	1	2	2	2	2	2	2	2	2
		Telephone Outlet 電話插座	2	2	1	2	2	2	2	2	2	2	2	1	2	2	2	2	2	2	2	2
		Fibre cable point 光纖點位	1	1	1	1	1	1	1	1	1	1	1	1	1	1	1	1	--	--	--	
		RJ45 Outlet RJ45插座	--	--	--	--	--	--	--	--	--	--	--	--	--	--	--	--	1	1	1	
	Miniature Circuit Breakers Board 總電掣箱	1	1	1	1	--	1	1	--	1	1	1	1	--	1	1	--	--	--	--		
	Non-exposed Type 非外露型	Fused Spur Unit 菲士接線座	1	1	2	1	--	2	1	--	1	1	2	1	--	2	1	--	2	3	2	
		13A Single Socket Outlet 13安培單位電插座	--	3	3	1	1	2	--	--	--	3	3	1	1	2	--	--	2	2	2	
		Switch for Air Conditioning Unit 冷氣機開關掣	--	--	--	--	--	--	--	--	--	--	--	--	--	--	--	--	3	3	3	
		Door Bell 門鈴	--	--	1	--	--	--	--	--	--	--	1	--	--	--	--	--	--	--	--	
		Drain Point for Washer Dryer 去水位供洗衣乾衣機	--	1	1	--	--	--	--	--	--	--	1	1	--	--	--	--	--	--	--	
Water Point for Washer Dryer 來水位供洗衣乾衣機		--	1	1	--	--	--	--	--	--	--	1	1	--	--	--	--	--	--	--		
RJ45 Outlet RJ45插座	--	--	--	--	--	--	--	--	--	--	--	--	--	--	--	--	2	2	2			

Notes:

- "1, 2," denotes the quantity of such provision(s) provided in the residential property.
- The symbol "--" as shown in the above table denotes "Not provided".
- 4/F, 13/F, 14/F, 24/F, 34/F & 44/F are omitted. 25/F is refuge floor.
- The vendor undertakes that if lifts or appliances of the specified brand name or model number are not installed in the Development, lifts or appliances of comparable quality will be installed.
- Non-exposed type socket outlet/power connection unit may be covered or hidden by false ceilings, bulk-heads, cabinets, claddings, non-concrete partition walls, designated pipe ducts or other materials.

備註:

- "1, 2," 表示提供於該住宅物業內的裝置數量。
- 上表「--」代表「不提供」。
- 不設4樓、13樓、14樓、24樓、34樓及44樓。25樓為隔火層。
- 賣方承諾如發展項目中沒有安裝指明的品牌名稱或產品型號的升降機或設備，便會安裝品質相若的升降機或設備。
- 非外露形電插座/電力接線座可能被假天花、假陣、貯存櫃、覆面、非混凝土間牆、指定之槽位或其他物料遮蓋。

SCHEDULE FOR LOCATION AND NUMBER OF MECHANICAL AND ELECTRICAL PROVISIONS OF RESIDENTIAL UNITS (TOWER 1) 住宅單位機電裝置位置及數量說明表 (第1座)

Location 位置	Description 描述	5/F 5樓								6/F-12/F, 15/F-23/F, 26/F-33/F, 35/F-43/F, 45/F-48/F 6樓-12樓, 15樓-23樓, 26樓-33樓, 35樓-43樓, 45樓-48樓								49/F 49樓			
		A	B	C	D	E	F	G	H	A	B	C	D	E	F	G	H	A	B	C	
Master Bedroom 主人睡房	Exposed Type 外露型	Lighting Switch 燈掣	7	3	--	2	2	3	2	1	5	3	--	2	2	3	2	1	5	5	5
		Lighting Point 燈位	2	1	--	1	2	1	1	1	2	1	--	1	2	1	1	1	2	1	2
		13A Twin Socket Outlet 13安培雙位電插座	1	1	--	1	1	1	1	1	1	1	--	1	1	1	1	1	2	1	1
		13A Single Socket Outlet 13安培單位電插座	1	--	--	1	1	--	1	1	1	--	--	1	1	--	1	1	1	2	3
		13A Single Socket Outlet with USB 13安培單位電插座連USB	1	1	--	1	1	1	1	1	1	1	--	1	1	1	1	1	1	1	1
		Switch for Air Conditioning Unit 冷氣機開關掣	1	1	--	1	1	1	1	1	1	1	--	1	1	1	1	1	1	1	2
		TV/FM Outlet 電視/電台天線插座	1	1	--	1	1	1	1	1	1	1	--	1	1	1	1	1	2	1	1
		Telephone Outlet 電話插座	1	1	--	1	1	1	1	1	1	1	--	1	1	1	1	1	1	1	1
RJ45 Outlet RJ45插座	--	--	--	--	--	--	--	--	--	--	--	--	--	--	--	--	1	1	1		
Bedroom 1 睡房 1	Exposed Type 外露型	Lighting Switch 燈掣	1	--	--	1	1	--	1	1	1	--	--	1	1	--	1	1	1	1	3
		Lighting Point 燈位	1	--	--	1	1	--	1	1	1	--	--	1	1	--	1	1	1	1	1
		13A Twin Socket Outlet 13安培雙位電插座	--	--	--	--	--	--	--	--	--	--	--	--	--	--	--	--	1	1	1
		13A Single Socket Outlet 13安培單位電插座	1	--	--	1	1	--	1	1	1	--	--	1	1	--	1	1	--	--	--
		13A Single Socket Outlet with USB 13安培單位電插座連USB	1	--	--	1	1	--	1	1	1	--	--	1	1	--	1	1	1	1	1
		Switch for Air Conditioning Unit 冷氣機開關掣	1	--	--	1	1	--	1	1	1	--	--	1	1	--	1	1	1	1	1
		TV/FM Outlet 電視/電台天線插座	--	--	--	--	--	--	--	--	--	--	--	--	--	--	--	--	1	1	1
		Telephone Outlet 電話插座	1	--	--	1	1	--	1	1	1	--	--	1	1	--	1	1	1	1	1

Notes:

- "1, 2," denotes the quantity of such provision(s) provided in the residential property.
- The symbol "--" as shown in the above table denotes "Not provided".
- 4/F, 13/F, 14/F, 24/F, 34/F & 44/F are omitted. 25/F is refuge floor.
- The vendor undertakes that if lifts or appliances of the specified brand name or model number are not installed in the Development, lifts or appliances of comparable quality will be installed.
- Non-exposed type socket outlet/power connection unit may be covered or hidden by false ceilings, bulk-heads, cabinets, claddings, non-concrete partition walls, designated pipe ducts or other materials.

備註:

- "1, 2," 表示提供於該住宅物業內的裝置數量。
- 上表「--」代表「不提供」。
- 不設4樓、13樓、14樓、24樓及44樓。25樓為隔火層。
- 賣方承諾如發展項目中沒有安裝指明的品牌名稱或產品型號的升降機或設備，便會安裝品質相若的升降機或設備。
- 非外露形電插座/電力接線座可能被假天花、假陣、貯存櫃、覆面、非混凝土間牆、指定之槽位或其他物料遮蓋。

SCHEDULE FOR LOCATION AND NUMBER OF MECHANICAL AND ELECTRICAL PROVISIONS OF RESIDENTIAL UNITS (TOWER 1) 住宅單位機電裝置位置及數量說明表 (第1座)

Location 位置	Description 描述	5/F 5樓								6/F-12/F, 15/F-23/F, 26/F-33/F, 35/F-43/F, 45/F-48/F 6樓-12樓, 15樓-23樓, 26樓-33樓, 35樓-43樓, 45樓-48樓								49/F 49樓			
		A	B	C	D	E	F	G	H	A	B	C	D	E	F	G	H	A	B	C	
Bedroom 2 睡房 2	Exposed Type 外露型	Lighting Switch 燈掣	1	--	--	--	--	--	--	--	1	--	--	--	--	--	--	--	5	2	4
		Lighting Point 燈位	1	--	--	--	--	--	--	--	1	--	--	--	--	--	--	--	1	1	2
		13A Twin Socket Outlet 13安培雙位電插座	--	--	--	--	--	--	--	--	--	--	--	--	--	--	--	--	1	1	1
		13A Single Socket Outlet 13安培單位電插座	1	--	--	--	--	--	--	--	1	--	--	--	--	--	--	--	1	--	--
		13A Single Socket Outlet with USB 13安培單位電插座連USB	1	--	--	--	--	--	--	--	1	--	--	--	--	--	--	--	1	1	1
		Switch for Air Conditioning Unit 冷氣機開關掣	1	--	--	--	--	--	--	--	1	--	--	--	--	--	--	--	1	1	1
		TV/FM Outlet 電視/電台天線插座	--	--	--	--	--	--	--	--	--	--	--	--	--	--	--	--	1	1	1
Telephone Outlet 電話插座	1	--	--	--	--	--	--	--	1	--	--	--	--	--	--	--	1	1	1		
Bedroom 3 睡房 3	Exposed Type 外露型	Lighting Switch 燈掣	--	--	--	--	--	--	--	--	--	--	--	--	--	--	--	1	1	--	
		Lighting Point 燈位	--	--	--	--	--	--	--	--	--	--	--	--	--	--	--	--	1	1	--
		13A Twin Socket Outlet 13安培雙位電插座	--	--	--	--	--	--	--	--	--	--	--	--	--	--	--	--	1	1	--
		13A Single Socket Outlet with USB 13安培單位電插座連USB	--	--	--	--	--	--	--	--	--	--	--	--	--	--	--	--	1	1	--
		Switch for Air Conditioning Unit 冷氣機開關掣	--	--	--	--	--	--	--	--	--	--	--	--	--	--	--	--	1	1	--
		TV/FM Outlet 電視/電台天線插座	--	--	--	--	--	--	--	--	--	--	--	--	--	--	--	--	1	1	--
		Telephone Outlet 電話插座	--	--	--	--	--	--	--	--	--	--	--	--	--	--	--	--	1	1	--

Notes:

- "1, 2," denotes the quantity of such provision(s) provided in the residential property.
- The symbol "--" as shown in the above table denotes "Not provided".
- 4/F, 13/F, 14/F, 24/F, 34/F & 44/F are omitted. 25/F is refuge floor.
- The vendor undertakes that if lifts or appliances of the specified brand name or model number are not installed in the Development, lifts or appliances of comparable quality will be installed.
- Non-exposed type socket outlet/power connection unit may be covered or hidden by false ceilings, bulk-heads, cabinets, claddings, non-concrete partition walls, designated pipe ducts or other materials.

備註:

- "1, 2," 表示提供於該住宅物業內的裝置數量。
- 上表「--」代表「不提供」。
- 不設4樓、13樓、14樓、24樓、34樓及44樓。25樓為隔火層。
- 賣方承諾如發展項目中沒有安裝指明的品牌名稱或產品型號的升降機或設備，便會安裝品質相若的升降機或設備。
- 非外露形電插座/電力接線座可能被假天花、假陣、貯存櫃、覆面、非混凝土間牆、指定之槽位或其他物料遮蓋。

SCHEDULE FOR LOCATION AND NUMBER OF MECHANICAL AND ELECTRICAL PROVISIONS OF RESIDENTIAL UNITS (TOWER 1) 住宅單位機電裝置位置及數量說明表 (第1座)

Location 位置	Description 描述	5/F 5樓								6/F-12/F, 15/F-23/F, 26/F-33/F, 35/F-43/F, 45/F-48/F 6樓-12樓, 15樓-23樓, 26樓-33樓, 35樓-43樓, 45樓-48樓								49/F 49樓			
		A	B	C	D	E	F	G	H	A	B	C	D	E	F	G	H	A	B	C	
Kitchen/ Open Kitchen 廚房/開放式 廚房	Exposed Type 外露型	Lighting Point 燈位	3	1	--	1	1	1	2	2	3	1	--	1	1	1	2	2	3	3	3
	13A Twin Socket Outlet 13安培雙位電插座	1	--	--	1	1	--	1	1	1	1	--	--	1	1	--	1	1	2	2	1
	13A Single Socket Outlet 13安培單位電插座	1	1	1	1	1	1	1	1	1	1	1	1	1	1	1	1	1	1	2	1
	13A Single Socket Outlet with USB 13安培單位電插座連USB	--	--	1	--	--	--	--	--	--	--	--	1	--	--	--	--	--	--	--	--
	Switch for Air Conditioning Unit 冷氣機開關掣	--	--	--	1	--	--	--	--	--	--	--	--	1	--	--	--	--	--	--	--
	Telephone Outlet 電話插座	--	--	1	--	--	--	--	--	--	--	--	1	--	--	--	--	--	--	--	--
	Non-exposed Type 非外露型	13A Single Socket Outlet 13安培單位電插座	3	--	--	2	2	1	2	2	3	--	--	2	2	1	2	2	4	4	3
	Fused Spur Unit 菲士接線座	7	3	2	3	4	3	7	7	7	7	3	2	3	4	3	7	7	8	7	7
	Stove Switch 焗爐開關掣	1	--	--	--	--	--	1	1	1	--	--	--	--	--	1	1	1	1	1	1
	Electrical Cooker Switch 電煮食爐開關掣	--	1	1	1	1	1	--	--	--	1	1	1	1	1	--	--	--	--	--	--
	Barbecue Grill Switch 燒烤爐開關掣	--	--	--	--	--	--	--	--	--	--	--	--	--	--	--	--	--	1	1	--
	Connection Unit 接線座	1	1	1	1	1	1	1	1	1	1	1	1	1	1	1	1	1	2	2	1
	Door Bell 門鈴	1	1	--	1	1	1	1	1	1	1	1	--	1	1	1	1	1	1	1	1
	Drain Point For Washer Dryer 去水位供洗衣乾衣機	1	--	--	1	1	1	1	1	1	1	--	--	1	1	1	1	1	1	1	1
Water Point For Washer Dryer 來水位供洗衣乾衣機	1	--	--	1	1	1	1	1	1	1	--	--	1	1	1	1	1	1	1	1	

Notes:

- "1, 2," denotes the quantity of such provision(s) provided in the residential property.
- The symbol "--" as shown in the above table denotes "Not provided".
- 4/F, 13/F, 14/F, 24/F, 34/F & 44/F are omitted. 25/F is refuge floor.
- The vendor undertakes that if lifts or appliances of the specified brand name or model number are not installed in the Development, lifts or appliances of comparable quality will be installed.
- Non-exposed type socket outlet/power connection unit may be covered or hidden by false ceilings, bulk-heads, cabinets, claddings, non-concrete partition walls, designated pipe ducts or other materials.

備註:

- "1, 2," 表示提供於該住宅物業內的裝置數量。
- 上表「--」代表「不提供」。
- 不設4樓、13樓、14樓、24樓、34樓及44樓。25樓為隔火層。
- 賣方承諾如發展項目中沒有安裝指明的品牌名稱或產品型號的升降機或設備，便會安裝品質相若的升降機或設備。
- 非外露型電插座/電力接線座可能被假天花、假陣、貯存櫃、覆面、非混凝土間牆、指定之槽位或其他物料遮蓋。

SCHEDULE FOR LOCATION AND NUMBER OF MECHANICAL AND ELECTRICAL PROVISIONS OF RESIDENTIAL UNITS (TOWER 1) 住宅單位機電裝置位置及數量說明表 (第1座)

Location 位置	Description 描述		5/F 5樓								6/F-12/F, 15/F-23/F, 26/F-33/F, 35/F-43/F, 45/F-48/F 6樓-12樓, 15樓-23樓, 26樓-33樓, 35樓-43樓, 45樓-48樓								49/F 49樓			
			A	B	C	D	E	F	G	H	A	B	C	D	E	F	G	H	A	B	C	
Master Bathroom 主人浴室	Exposed Type 外露型	Lighting Point 燈位	4	--	--	--	--	--	--	--	4	--	--	--	--	--	--	--	6	5	6	
		13A Single Socket Outlet with USB 13安培單位電插座連USB	1	--	--	--	--	--	--	--	1	--	--	--	--	--	--	--	1	1	1	
		Thermo Ventilator Switch ⁶ 浴室寶開關掣 ⁶	1	--	--	--	--	--	--	--	1	--	--	--	--	--	--	--	1	1	1	
	Non-exposed Type 非外露型	Fused Spur Unit 菲士接線座	4	--	--	--	--	--	--	--	4	--	--	--	--	--	--	--	4	4	4	
		Connection Unit 接線座	1	--	--	--	--	--	--	--	1	--	--	--	--	--	--	--	1	1	1	
Bathroom 浴室 / Bathroom 1 浴室 1	Exposed Type 外露型	Lighting Point 燈位	4	4	3	4	4	4	4	4	4	4	3	4	4	4	4	4	4	4	4	
		13A Single Socket Outlet with USB 13安培單位電插座連USB	1	1	1	1	1	1	1	1	1	1	1	1	1	1	1	1	1	1	1	1
		Thermo Ventilator Switch ⁶ 浴室寶開關掣 ⁶	1	1	1	1	1	1	1	1	1	1	1	1	1	1	1	1	1	1	1	1
	Non-exposed Type 非外露型	Fused Spur Unit 菲士接線座	2	3	2	4	4	3	4	4	2	3	2	4	4	3	4	4	2	2	2	
		Connection Unit 接線座	1	1	1	1	1	1	1	1	1	1	1	1	1	1	1	1	1	1	1	1
Bathroom 2 浴室 2	Exposed Type 外露型	Lighting Point 燈位	--	--	--	--	--	--	--	--	--	--	--	--	--	--	--	--	4	--	4	
		13A Single Socket Outlet with USB 13安培單位電插座連USB	--	--	--	--	--	--	--	--	--	--	--	--	--	--	--	--	--	1	--	1
	Non-exposed Type 非外露型	Fused Spur Unit 菲士接線座	--	--	--	--	--	--	--	--	--	--	--	--	--	--	--	--	3	--	3	
		Connection Unit 接線座	--	--	--	--	--	--	--	--	--	--	--	--	--	--	--	--	--	--	--	--

Notes:

- "1, 2," denotes the quantity of such provision(s) provided in the residential property.
- The symbol "--" as shown in the above table denotes "Not provided".
- 4/F, 13/F, 14/F, 24/F, 34/F & 44/F are omitted. 25/F is refuge floor.
- The vendor undertakes that if lifts or appliances of the specified brand name or model number are not installed in the Development, lifts or appliances of comparable quality will be installed.
- Non-exposed type socket outlet/power connection unit may be covered or hidden by false ceilings, bulk-heads, cabinets, claddings, non-concrete partition walls, designated pipe ducts or other materials.
- Thermo ventilator switch may change to non-exposed type due to statutory requirement or power supply company requirement.

備註:

- "1, 2," 表示提供於該住宅物業內的裝置數量。
- 上表「--」代表「不提供」。
- 不設4樓、13樓、14樓、24樓、34樓及44樓。25樓為隔火層。
- 賣方承諾如發展項目中沒有安裝指明的品牌名稱或產品型號的升降機或設備，便會安裝品質相若的升降機或設備。
- 非外露型電插座/電力接線座可能被假天花、假陣、貯存櫃、覆面、非混凝土間牆、指定之槽位或其他物料遮蓋。
- 浴室寶開關掣可能更改為非外露型，視乎法定要求或電力供應公司要求。

SCHEDULE FOR LOCATION AND NUMBER OF MECHANICAL AND ELECTRICAL PROVISIONS OF RESIDENTIAL UNITS (TOWER 1) 住宅單位機電裝置位置及數量說明表 (第1座)

Location 位置	Description 描述	5/F 5樓								6/F-12/F, 15/F-23/F, 26/F-33/F, 35/F-43/F, 45/F-48/F 6樓-12樓, 15樓-23樓, 26樓-33樓, 35樓-43樓, 45樓-48樓								49/F 49樓			
		A	B	C	D	E	F	G	H	A	B	C	D	E	F	G	H	A	B	C	
Utility Room 工作間	Exposed Type 外露型	Lighting Switch 燈掣	--	--	--	--	1	--	--	1	--	--	--	--	1	--	--	1	4	3	1
		Lighting Point 燈位	--	--	--	--	1	--	--	1	--	--	--	--	1	--	--	1	1	1	1
		13A Single Socket Outlet 13安培單位電插座	--	--	--	--	2	--	--	2	--	--	--	--	2	--	--	2	3	3	3
		Telephone Outlet 電話插座	--	--	--	--	--	--	--	--	--	--	--	--	--	--	--	--	1	1	1
		RJ45 Outlet RJ45插座	--	--	--	--	--	--	--	--	--	--	--	--	--	--	--	--	1	1	1
		Switch for Air Conditioning Unit 冷氣機開關掣	--	--	--	--	--	--	--	--	--	--	--	--	--	--	--	--	1	1	--
		Miniature Circuit Breakers Board 總電掣箱	--	--	--	--	1	--	--	1	--	--	--	--	1	--	--	1	1	1	1
Fibre Cable Point 光纖點位	--	--	--	--	--	--	--	--	--	--	--	--	--	--	--	--	1	1	1		
Lavatory 洗手間	Exposed Type 外露型	Lighting Point 燈位	--	--	--	--	--	--	--	--	--	--	--	--	--	--	--	--	--	2	
		Non-exposed Type 非外露型	Fused Spur Unit 菲士接線座	--	--	--	--	--	--	--	--	--	--	--	--	--	--	--	--	--	2
Lavatory 1 洗手間 1 / Lavatory inside Utility Room 工作間內之洗 手間	Exposed Type 外露型	Lighting Point 燈位	--	--	--	--	--	--	--	--	--	--	--	--	--	--	--	1	1	--	
		Non-exposed Type 非外露型	Fused Spur Unit 菲士接線座	--	--	--	--	--	--	--	--	--	--	--	--	--	--	--	1	1	--
Store Room 儲物室	Exposed Type 外露型	Lighting Switch 燈掣	--	--	--	--	--	--	--	--	--	--	--	--	--	--	--	--	1	1	
		Lighting Point 燈位	--	--	--	--	--	--	--	--	--	--	--	--	--	--	--	1	1	1	
		13A Single Socket Outlet 13安培單位電插座	--	--	--	--	--	--	--	--	--	--	--	--	--	--	--	1	1	1	
Staircase 樓梯	Exposed Type 外露型	Lighting Switch 燈掣	--	--	--	--	--	--	--	--	--	--	--	--	--	--	--	4	3	3	
		Lighting Point 燈位	--	--	--	--	--	--	--	--	--	--	--	--	--	--	--	4	3	2	
		13A Single Socket Outlet 13安培單位電插座	--	--	--	--	--	--	--	--	--	--	--	--	--	--	--	1	1	1	

Notes:

- "1, 2," denotes the quantity of such provision(s) provided in the residential property.
- The symbol "--" as shown in the above table denotes "Not provided".
- 4/F, 13/F, 14/F, 24/F, 34/F & 44/F are omitted. 25/F is refuge floor.
- The vendor undertakes that if lifts or appliances of the specified brand name or model number are not installed in the Development, lifts or appliances of comparable quality will be installed.
- Non-exposed type socket outlet/power connection unit may be covered or hidden by false ceilings, bulk-heads, cabinets, claddings, non-concrete partition walls, designated pipe ducts or other materials.

備註:

- "1, 2," 表示提供於該住宅物業內的裝置數量。
- 上表「--」代表「不提供」。
- 不設4樓、13樓、14樓、24樓、34樓及44樓。25樓為隔火層。
- 賣方承諾如發展項目中沒有安裝指明的品牌名稱或產品型號的升降機或設備，便會安裝品質相若的升降機或設備。
- 非外露形電插座/電力接線座可能被假天花、假陣、貯存櫃、覆面、非混凝土間牆、指定之槽位或其他物料遮蓋。

SCHEDULE FOR LOCATION AND NUMBER OF MECHANICAL AND ELECTRICAL PROVISIONS OF RESIDENTIAL UNITS (TOWER 1) 住宅單位機電裝置位置及數量說明表 (第1座)

Location 位置	Description 描述		5/F 5樓								6/F-12/F, 15/F-23/F, 26/F-33/F, 35/F-43/F, 45/F-48/F 6樓-12樓, 15樓-23樓, 26樓-33樓, 35樓-43樓, 45樓-48樓								49/F 49樓		
			A	B	C	D	E	F	G	H	A	B	C	D	E	F	G	H	A	B	C
Balcony 露台	Exposed Type 外露型	Balcony Light 露台燈	--	1	1	1	--	--	--	--	1	1	1	1	1	1	1	1	2	1	1
	Non-exposed Type 非外露型	Fused Spur Unit 菲士接線座	--	1	1	1	--	--	--	--	--	1	1	1	1	1	--	--	--	--	--
Utility Platform 工作平台	Exposed Type 外露型	Utility Platform Light 工作平台燈	--	--	--	1	--	--	--	--	1	--	--	1	1	--	1	1	--	1	--
Flat Roof 平台	Exposed Type 外露型	Lighting Point 燈位	11	--	--	--	10	5	11	16	--	--	--	--	--	--	--	--	2	2	4
		13A Weatherproof Single Socket Outlet 13安培防水單位電插座	3	--	--	--	2	2	2	3	--	--	--	--	--	--	--	--	1	1	2
		A/C Unit Weatherproof Isolator 空調機防水開關掣	--	--	--	--	--	--	--	--	--	--	--	--	--	--	--	--	--	--	1
	Non-exposed Type 非外露型	Fused Spur Unit 菲士接線座	--	--	--	--	1	1	--	--	--	--	--	--	--	--	--	--	--	--	--
Private Roof 私人天台	Exposed Type 外露型	Lighting Point 燈位	--	--	--	--	--	--	--	--	--	--	--	--	--	--	--	--	9	7	12
		13A Weatherproof Single Socket Outlet 13安培防水單位電插座	--	--	--	--	--	--	--	--	--	--	--	--	--	--	--	--	4	3	4
		A/C Unit Weatherproof Isolator 空調機防水開關掣	--	--	--	--	--	--	--	--	--	--	--	--	--	--	--	--	--	1	--
	Non-exposed Type 非外露型	13A Weatherproof Single Socket Outlet 13安培防水單位電插座	--	--	--	--	--	--	--	--	--	--	--	--	--	--	--	--	1	1	1
		Weatherproof RJ45 Outlet RJ45防水插座	--	--	--	--	--	--	--	--	--	--	--	--	--	--	--	--	1	1	1
Air- Conditioner Platform 空調機平台	Exposed Type 外露型	A/C Unit Weatherproof Isolator 空調機防水開關掣	3	1	1	1	2	1	2	3	3	1	1	1	2	1	2	3	4	2	2

Notes:

- "1, 2," denotes the quantity of such provision(s) provided in the residential property.
- The symbol "--" as shown in the above table denotes "Not provided".
- 4/F, 13/F, 14/F, 24/F, 34/F & 44/F are omitted. 25/F is refuge floor.
- The vendor undertakes that if lifts or appliances of the specified brand name or model number are not installed in the Development, lifts or appliances of comparable quality will be installed.
- Non-exposed type socket outlet/power connection unit may be covered or hidden by false ceilings, bulk-heads, cabinets, claddings, non-concrete partition walls, designated pipe ducts or other materials.

備註:

- "1, 2," 表示提供於該住宅物業內的裝置數量。
- 上表「--」代表「不提供」。
- 不設4樓、13樓、14樓、24樓、34樓及44樓。25樓為隔火層。
- 賣方承諾如發展項目中沒有安裝指明的品牌名稱或產品型號的升降機或設備，便會安裝品質相若的升降機或設備。
- 非外露形電插座/電力接線座可能被假天花、假陣、貯存櫃、覆面、非混凝土間牆、指定之槽位或其他物料遮蓋。

SCHEDULE FOR LOCATION AND NUMBER OF MECHANICAL AND ELECTRICAL PROVISIONS OF RESIDENTIAL UNITS (TOWER 2) 住宅單位機電裝置位置及數量說明表 (第2座)

Location 位置	Description 描述	5/F 5樓								6/F-12/F, 15/F-23/F, 26/F-33/F, 35/F-43/F, 45/F-47/F 6樓-12樓, 15樓-23樓, 26樓-33樓, 35樓-43樓, 45樓-47樓								48/F 48樓								49/F 49樓			
		A	B	C	D	E	F	G	H	A	B	C	D	E	F	G	H	A	B	C	D	E	F	G	H	A	B		
Main Entrance 大門入口	Exposed Type 外露型	Door Bell Push Button 門鈴按鈕	1	1	1	1	1	1	1	1	1	1	1	1	1	1	1	1	1	1	1	1	1	1	1	1	1	1	
Living Room, Dining Room, Corridor & Pantry 客廳、飯廳、 走廊及茶水間	Exposed Type 外露型	Lighting Switch 燈掣	5	13	14	14	7	15	14	7	4	12	13	13	6	13	13	6	4	12	13	13	6	13	13	6	17	19	
		Lighting Point 燈位	4	6	7	6	4	7	5	4	4	6	7	6	4	7	5	4	4	6	7	6	4	7	5	4	31	31	
		Video Door Phone 門口視像對講機	1	1	1	1	1	1	1	1	1	1	1	1	1	1	1	1	1	1	1	1	1	1	1	1	1	1	
		13A Twin Socket Outlet 13安培雙位電插座	3	3	3	3	3	3	3	3	3	3	3	3	3	3	3	3	3	3	3	3	3	3	3	3	3	2	5
		13A Single Socket Outlet 13安培單位電插座	--	--	--	--	--	--	--	1	--	--	--	--	--	--	--	1	--	--	--	--	--	--	--	1	5	5	
		13A Single Socket Outlet with USB 13安培單位電插座連USB	--	--	--	--	--	--	--	1	--	--	--	--	--	--	--	1	--	--	--	--	--	--	--	1	--	--	
		Fused Spur Unit 菲士接線座	--	--	--	--	--	--	--	--	--	--	--	--	--	--	--	--	--	--	--	--	--	--	--	--	3	4	
		Switch for Curtain 窗簾開關掣	--	--	--	--	--	--	--	--	--	--	--	--	--	--	--	--	--	--	--	--	--	--	--	--	--	3	4
		Switch for Air Conditioning Unit 冷氣機開關掣	1	1	2	1	1	1	1	1	1	1	1	2	1	1	1	1	1	1	1	2	1	1	1	1	1	--	--
		TV/FM Outlet 電視/電台天線插座	2	2	2	2	2	2	2	1	2	2	2	2	2	2	2	1	2	2	2	2	2	2	2	2	1	2	2
		Telephone Outlet 電話插座	2	2	2	2	2	2	2	2	2	2	2	2	2	2	2	2	2	2	2	2	2	2	2	2	2	2	2
		Fibre cable point 光纖點位	1	1	1	1	1	1	1	1	1	1	1	1	1	1	1	1	1	1	1	1	1	1	1	1	1	--	--
		RJ45 Outlet RJ45插座	--	--	--	--	--	--	--	--	--	--	--	--	--	--	--	--	--	--	--	--	--	--	--	--	--	1	1
	Miniature Circuit Breakers Board 總電掣箱	1	1	--	--	1	--	--	1	1	1	--	--	1	--	--	1	1	1	--	--	1	--	--	1	--	--		
	Non-exposed Type 非外露型	Fused Spur Unit 菲士接線座	1	1	1	1	1	1	1	1	1	1	1	1	1	1	1	1	1	1	1	1	1	1	1	1	3	5	
		13A Single Socket Outlet 13安培單位電插座	--	--	--	--	--	--	--	3	--	--	--	--	--	--	--	3	--	--	--	--	--	--	--	3	6	4	
		Switch for Air Conditioning Unit 冷氣機開關掣	--	--	--	--	--	--	--	--	--	--	--	--	--	--	--	--	--	--	--	--	--	--	--	--	3	3	
Drain Point For Washer Dryer 去水位供洗衣乾衣機		--	--	--	--	--	--	--	1	--	--	--	--	--	--	--	1	--	--	--	--	--	--	--	1	1	--		
Water Point For Washer Dryer 來水位供洗衣乾衣機		--	--	--	--	--	--	--	1	--	--	--	--	--	--	--	1	--	--	--	--	--	--	--	1	1	--		
RJ45 Outlet RJ45插座	--	--	--	--	--	--	--	--	--	--	--	--	--	--	--	--	--	--	--	--	--	--	--	--	2	2			

Notes:

- "1, 2," denotes the quantity of such provision(s) provided in the residential property.
- The symbol "--" as shown in the above table denotes "Not provided".
- 4/F, 13/F, 14/F, 24/F, 34/F & 44/F are omitted. 25/F is refuge floor.
- The vendor undertakes that if lifts or appliances of the specified brand name or model number are not installed in the Development, lifts or appliances of comparable quality will be installed.
- Non-exposed type socket outlet/power connection unit may be covered or hidden by false ceilings, bulkheads, cabinets, claddings, non-concrete partition walls, designated pipe ducts or other materials.

備註:

- "1, 2," 表示提供於該住宅物業內的裝置數量。
- 上表「--」代表「不提供」。
- 不設4樓、13樓、14樓、24樓、34樓及44樓。25樓為隔火層。
- 賣方承諾如發展項目中沒有安裝指明的品牌名稱或產品型號的升降機或設備，便會安裝品質相若的升降機或設備。
- 非外露形電插座/電力接線座可能被假天花、假陣、貯存櫃、覆面、非混凝土間牆、指定之槽位或其他物料遮蓋。

SCHEDULE FOR LOCATION AND NUMBER OF MECHANICAL AND ELECTRICAL PROVISIONS OF RESIDENTIAL UNITS (TOWER 2) 住宅單位機電裝置位置及數量說明表 (第2座)

Location 位置	Description 描述	5/F 5樓								6/F-12/F, 15/F-23/F, 26/F-33/F, 35/F-43/F, 45/F-47/F 6樓-12樓, 15樓-23樓, 26樓-33樓, 35樓-43樓, 45樓-47樓								48/F 48樓								49/F 49樓			
		A	B	C	D	E	F	G	H	A	B	C	D	E	F	G	H	A	B	C	D	E	F	G	H	A	B		
Master Bedroom 主人睡房	Exposed Type 外露型	Lighting Switch 燈掣	3	2	6	3	2	5	1	--	3	2	5	2	2	5	2	--	1	1	1	1	1	1	1	1	--	5	4
		Lighting Point 燈位	1	1	1	1	1	2	1	--	1	1	1	1	1	2	1	--	1	1	1	1	1	2	1	--	4	2	
		13A Twin Socket Outlet 13安培雙位電插座	1	1	1	1	1	1	1	--	1	1	1	1	1	1	1	--	1	1	1	1	1	1	1	--	2	1	
		13A Single Socket Outlet 13安培單位電插座	--	1	1	1	--	1	1	--	--	1	1	1	--	1	1	--	--	1	1	1		1	1	--	1	2	
		13A Single Socket Outlet with USB 13安培單位電插座連USB	1	1	1	1	1	1	1	--	1	1	1	1	1	1	1	--	1	1	1	1	1	1	1	--	1	1	
		Switch for Air Conditioning Unit 冷氣機開關掣	1	1	1	1	1	1	1	--	1	1	1	1	1	1	1	--	1	1	1	1	1	1	1	--	1	1	
		TV/FM Outlet 電視/電台天線插座	1	1	1	1	1	1	1	--	1	1	1	1	1	1	1	--	1	1	1	1	1	1	1	--	1	1	
		Telephone Outlet 電話插座	1	1	1	1	1	1	1	--	1	1	1	1	1	1	1	--	1	1	1	1	1	1	1	--	1	1	
		RJ45 Outlet RJ45插座	--	--	--	--	--	--	--	--	--	--	--	--	--	--	--	--	--	--	--	--	--	--	--	--	1	1	
Non-exposed Type 非外露型	Fused Spur Unit 菲士接線座	--	--	--	--	--	--	--	--	--	--	--	--	--	--	--	--	--	--	--	--	--	--	--	--	1	--		
Bedroom 1 睡房 1	Exposed Type 外露型	Lighting Switch 燈掣	--	1	1	1	--	1	3	--	--	1	1	1	--	1	1	--	--	1	1	1	--	1	1	--	1	1	
		Lighting Point 燈位	--	1	1	1	--	1	1	--	--	1	1	1	--	1	1	--	--	1	1	1	--	1	1	--	2	1	
		13A Twin Socket Outlet 13安培雙位電插座	--	--	--	--	--	--	--	--	--	--	--	--	--	--	--	--	--	--	--	--	--	--	--	--	1	1	
		13A Single Socket Outlet 13安培單位電插座	--	1	1	1	--	1	1	--	--	1	1	1	--	1	1	--	--	1	1	1	--	1	1	--	--	--	
		13A Single Socket Outlet with USB 13安培單位電插座連USB	--	1	1	1	--	1	1	--	--	1	1	1	--	1	1	--	--	1	1	1	--	1	1	--	1	1	
		Switch for Air Conditioning Unit 冷氣機開關掣	--	1	1	1	--	1	1	--	--	1	1	1	--	1	1	--	--	1	1	1	--	1	1	--	1	1	
		TV/FM Outlet 電視/電台天線插座	--	--	--	--	--	--	--	--	--	--	--	--	--	--	--	--	--	--	--	--	--	--	--	--	1	1	
		Telephone Outlet 電話插座	--	1	1	1	--	1	1	--	--	1	1	1	--	1	1	--	--	1	1	1	--	1	1	--	1	1	

Notes:

- "1, 2," denotes the quantity of such provision(s) provided in the residential property.
- The symbol "--" as shown in the above table denotes "Not provided".
- 4/F, 13/F, 14/F, 24/F, 34/F & 44/F are omitted. 25/F is refuge floor.
- The vendor undertakes that if lifts or appliances of the specified brand name or model number are not installed in the Development, lifts or appliances of comparable quality will be installed.
- Non-exposed type socket outlet/power connection unit may be covered or hidden by false ceilings, bulkheads, cabinets, claddings, non-concrete partition walls, designated pipe ducts or other materials.

備註:

- "1, 2," 表示提供於該住宅物業內的裝置數量。
- 上表「--」代表「不提供」。
- 不設4樓、13樓、14樓、24樓、34樓及44樓。25樓為隔火層。
- 賣方承諾如發展項目中沒有安裝指明的品牌名稱或產品型號的升降機或設備，便會安裝品質相若的升降機或設備。
- 非外露形電插座/電力接線座可能被假天花、假陣、貯存櫃、覆面、非混凝土間牆、指定之槽位或其他物料遮蓋。

SCHEDULE FOR LOCATION AND NUMBER OF MECHANICAL AND ELECTRICAL PROVISIONS OF RESIDENTIAL UNITS (TOWER 2) 住宅單位機電裝置位置及數量說明表 (第2座)

Location 位置	Description 描述	5/F 5樓								6/F-12/F, 15/F-23/F, 26/F-33/F, 35/F-43/F, 45/F-47/F 6樓-12樓, 15樓-23樓, 26樓-33樓, 35樓-43樓, 45樓-47樓								48/F 48樓								49/F 49樓		
		A	B	C	D	E	F	G	H	A	B	C	D	E	F	G	H	A	B	C	D	E	F	G	H	A	B	
Bedroom 2 睡房 2	Exposed Type 外露型	Lighting Switch 燈掣	--	--	1	--	--	1	--	--	--	--	1	--	--	1	--	--	--	--	1	--	--	1	--	--	4	4
		Lighting Point 燈位	--	--	1	--	--	1	--	--	--	--	1	--	--	1	--	--	--	--	1	--	--	1	--	--	2	1
		13A Twin Socket Outlet 13安培雙位電插座	--	--	--	--	--	--	--	--	--	--	--	--	--	--	--	--	--	--	--	--	--	--	--	--	1	1
		13A Single Socket Outlet 13安培單位電插座	--	--	1	--	--	1	--	--	--	--	1	--	--	1	--	--	--	--	1	--	--	1	--	--	--	--
		13A Single Socket Outlet with USB 13安培單位電插座連USB	--	--	1	--	--	1	--	--	--	--	1	--	--	1	--	--	--	--	1	--	--	1	--	--	1	1
		Switch for Air Conditioning Unit 冷氣機開關掣	--	--	1	--	--	1	--	--	--	--	1	--	--	1	--	--	--	--	1	--	--	1	--	--	1	1
		TV/FM Outlet 電視/電台天線插座	--	--	--	--	--	--	--	--	--	--	--	--	--	--	--	--	--	--	--	--	--	--	--	--	1	1
		Telephone Outlet 電話插座	--	--	1	--	--	1	--	--	--	--	1	--	--	1	--	--	--	--	1	--	--	1	--	--	1	1
Bedroom 3 睡房 3	Exposed Type 外露型	Lighting Switch 燈掣	--	--	--	--	--	--	--	--	--	--	--	--	--	--	--	--	--	--	--	--	--	--	--	5	5	
		Lighting Point 燈位	--	--	--	--	--	--	--	--	--	--	--	--	--	--	--	--	--	--	--	--	--	--	--	--	3	4
		13A Twin Socket Outlet 13安培雙位電插座	--	--	--	--	--	--	--	--	--	--	--	--	--	--	--	--	--	--	--	--	--	--	--	--	1	1
		13A Single Socket Outlet 13安培單位電插座	--	--	--	--	--	--	--	--	--	--	--	--	--	--	--	--	--	--	--	--	--	--	--	--	2	2
		13A Single Socket Outlet with USB 13安培單位電插座連USB	--	--	--	--	--	--	--	--	--	--	--	--	--	--	--	--	--	--	--	--	--	--	--	--	1	1
		Switch for Air Conditioning Unit 冷氣機開關掣	--	--	--	--	--	--	--	--	--	--	--	--	--	--	--	--	--	--	--	--	--	--	--	--	1	1
		TV/FM Outlet 電視/電台天線插座	--	--	--	--	--	--	--	--	--	--	--	--	--	--	--	--	--	--	--	--	--	--	--	--	1	1
		Telephone Outlet 電話插座	--	--	--	--	--	--	--	--	--	--	--	--	--	--	--	--	--	--	--	--	--	--	--	--	1	1
		RJ45 Outlet RJ45插座	--	--	--	--	--	--	--	--	--	--	--	--	--	--	--	--	--	--	--	--	--	--	--	--	--	1

Notes:

- "1, 2," denotes the quantity of such provision(s) provided in the residential property.
- The symbol "--" as shown in the above table denotes "Not provided".
- 4/F, 13/F, 14/F, 24/F, 34/F & 44/F are omitted. 25/F is refuge floor.
- The vendor undertakes that if lifts or appliances of the specified brand name or model number are not installed in the Development, lifts or appliances of comparable quality will be installed.
- Non-exposed type socket outlet/power connection unit may be covered or hidden by false ceilings, bulk-heads, cabinets, claddings, non-concrete partition walls, designated pipe ducts or other materials.

備註:

- "1, 2," 表示提供於該住宅物業內的裝置數量。
- 上表「--」代表「不提供」。
- 不設4樓、13樓、14樓、24樓、34樓及44樓。25樓為隔火層。
- 賣方承諾如發展項目中沒有安裝指明的品牌名稱或產品型號的升降機或設備，便會安裝品質相若的升降機或設備。
- 非外露形電插座/電力接線座可能被假天花、假陣、貯存櫃、覆面、非混凝土間牆、指定之槽位或其他物料遮蓋。

SCHEDULE FOR LOCATION AND NUMBER OF MECHANICAL AND ELECTRICAL PROVISIONS OF RESIDENTIAL UNITS (TOWER 2) 住宅單位機電裝置位置及數量說明表 (第2座)

Location 位置	Description 描述	5/F 5樓								6/F-12/F, 15/F-23/F, 26/F-33/F, 35/F-43/F, 45/F-47/F 6樓-12樓, 15樓-23樓, 26樓-33樓, 35樓-43樓, 45樓-47樓								48/F 48樓						49/F 49樓				
		A	B	C	D	E	F	G	H	A	B	C	D	E	F	G	H	A	B	C	D	E	F	G	H	A	B	
Kitchen/ Open Kitchen 廚房/開放式 廚房	Exposed Type 外露型	Lighting Point 燈位	1	1	3	2	1	3	4	1	1	1	3	2	1	3	4	1	--	1	3	2	-	3	4	--	3	3
		13A Twin Socket Outlet 13安培雙位電插座	1	1	1	1	1	1	1	--	1	1	1	1	1	1	1	--	1	1	1	1	1	1	1	--	2	1
		13A Single Socket Outlet 13安培單位電插座	1	1	1	1	1	1	--	1	1	1	1	1	1	1	--	1	1	1	1	1	1	1	--	1	2	1
	Non-exposed Type 非外露型	Fused Spur Unit 菲士接線座	3	3	7	6	3	6	7	3	3	3	7	6	3	6	7	3	3	3	7	6	3	6	7	3	6	6
		13A Single Socket Outlet 13安培單位電插座	3	3	3	2	3	3	2	--	3	3	3	2	3	3	2	--	3	3	3	2	3	3	2	--	1	2
		Stove Switch 焗爐開關掣	--	--	1	1	--	1	1	--	--	--	1	1	--	1	1	--	--	--	1	1	--	1	1	--	1	1
		Electrical Cooker Switch 電煮食爐開關掣	1	1	--	--	1	--	--	1	1	1	--	--	1	--	--	1	1	1	--	--	1	--	--	1	--	--
		Barbecue Grill Switch 燒烤爐開關掣	--	--	--	--	--	--	--	--	--	--	--	--	--	--	--	--	--	--	--	--	--	--	--	--	1	1
		Connection Unit 接線座	1	1	1	1	1	1	1	1	1	1	1	1	1	1	1	1	1	1	1	1	1	1	1	1	2	2
		Door Bell 門鈴	1	1	1	1	1	1	1	1	1	1	1	1	1	1	1	1	1	1	1	1	1	1	1	1	1	1
Drain Point For Washer Dryer 去水位供洗衣乾衣機	1	1	1	1	1	1	1	-	1	1	1	1	1	1	1	-	1	1	1	1	1	1	1	--	--	1		
Water Point For Washer Dryer 來水位供洗衣乾衣機	1	1	1	1	1	1	1	-	1	1	1	1	1	1	1	-	1	1	1	1	1	1	1	--	--	1		

Notes:

- “1, 2,” denotes the quantity of such provision(s) provided in the residential property.
- The symbol "--" as shown in the above table denotes "Not provided".
- 4/F, 13/F, 14/F, 24/F, 34/F & 44/F are omitted. 25/F is refuge floor.
- The vendor undertakes that if lifts or appliances of the specified brand name or model number are not installed in the Development, lifts or appliances of comparable quality will be installed.
- Non-exposed type socket outlet/power connection unit may be covered or hidden by false ceilings, bulk-heads, cabinets, claddings, non-concrete partition walls, designated pipe ducts or other materials.

備註:

- “1, 2,” 表示提供於該住宅物業內的裝置數量。
- 上表「--」代表「不提供」。
- 不設4樓、13樓、14樓、24樓、34樓及44樓。25樓為隔火層。
- 賣方承諾如發展項目中沒有安裝指明的品牌名稱或產品型號的升降機或設備，便會安裝品質相若的升降機或設備。
- 非外露形電插座/電力接線座可能被假天花、假陣、貯存櫃、覆面、非混凝土間牆、指定之槽位或其他物料遮蓋。

SCHEDULE FOR LOCATION AND NUMBER OF MECHANICAL AND ELECTRICAL PROVISIONS OF RESIDENTIAL UNITS (TOWER 2) 住宅單位機電裝置位置及數量說明表 (第2座)

Location 位置	Description 描述	5/F 5樓								6/F-12/F, 15/F-23/F, 26/F-33/F, 35/F-43/F, 45/F-47/F 6樓-12樓, 15樓-23樓, 26樓-33樓, 35樓-43樓, 45樓-47樓								48/F 48樓								49/F 49樓		
		A	B	C	D	E	F	G	H	A	B	C	D	E	F	G	H	A	B	C	D	E	F	G	H	A	B	
Master Bathroom 主人浴室	Exposed Type 外露型	Lighting Point 燈位	--	--	4	--	--	4	--	--	--	--	4	--	--	4	--	--	--	--	4	--	--	4	--	--	6	7
		13A Single Socket Outlet with USB 13安培單位電插座連USB	--	--	1	--	--	1	--	--	--	--	1	--	--	1	--	--	--	--	1	--	--	1	--	--	1	1
		Thermo Ventilator Switch ⁶ 浴室寶開關掣 ⁶	--	--	1	--	--	1	--	--	--	--	1	--	--	1	--	--	--	--	1	--	--	1	--	--	1	1
	Non-exposed Type 非外露型	Fused Spur Unit 菲士接線座	--	--	4	--	--	4	--	--	--	--	4	--	--	4	--	--	--	--	4	--	--	4	--	--	4	4
		Connection Unit 接線座	--	--	1	--	--	1	--	--	--	--	1	--	--	1	--	--	--	--	1	--	--	1	--	--	1	1
Bathroom 浴室 / Bathroom 1 浴室 1	Exposed Type 外露型	Lighting Point 燈位	5	4	4	4	4	4	4	4	5	4	4	4	4	4	4	4	5	4	4	4	4	4	4	4	4	4
		13A Single Socket Outlet with USB 13安培單位電插座連USB	1	1	1	1	1	1	1	1	1	1	1	1	1	1	1	1	1	1	1	1	1	1	1	1	1	1
		Thermo Ventilator Switch ⁶ 浴室寶開關掣 ⁶	1	1	1	1	1	1	1	1	1	1	1	1	1	1	1	1	1	1	1	1	1	1	1	1	1	1
	Non-exposed Type 非外露型	Fused Spur Unit 菲士接線座	3	4	2	4	3	2	4	3	3	4	2	4	3	2	4	3	3	4	2	4	3	2	4	3	2	2
		Connection Unit 接線座	1	1	1	1	1	1	1	1	1	1	1	1	1	1	1	1	1	1	1	1	1	1	1	1	1	

Notes:

- “1, 2, ……” denotes the quantity of such provision(s) provided in the residential property.
- The symbol “--” as shown in the above table denotes “Not provided”.
- 4/F, 13/F, 14/F, 24/F, 34/F & 44/F are omitted. 25/F is refuge floor.
- The vendor undertakes that if lifts or appliances of the specified brand name or model number are not installed in the Development, lifts or appliances of comparable quality will be installed.
- Non-exposed type socket outlet/power connection unit may be covered or hidden by false ceilings, bulk-heads, cabinets, claddings, non-concrete partition walls, designated pipe ducts or other materials.
- Thermo ventilator switch may change to non-exposed type due to statutory requirement or power supply company requirement.

備註:

- “1, 2, ……” 表示提供於該住宅物業內的裝置數量。
- 上表「--」代表「不提供」。
- 不設4樓、13樓、14樓、24樓、34樓及44樓。25樓為隔火層。
- 賣方承諾如發展項目中沒有安裝指明的品牌名稱或產品型號的升降機或設備，便會安裝品質相若的升降機或設備。
- 非外露型電插座/電力接線座可能被假天花、假陣、貯存櫃、覆面、非混凝土間牆、指定之槽位或其他物料遮蓋。
- 浴室寶開關掣可能更改為非外露型，視乎法定要求或電力供應公司要求。

SCHEDULE FOR LOCATION AND NUMBER OF MECHANICAL AND ELECTRICAL PROVISIONS OF RESIDENTIAL UNITS (TOWER 2) 住宅單位機電裝置位置及數量說明表 (第2座)

Location 位置	Description 描述	5/F 5樓								6/F-12/F, 15/F-23/F, 26/F-33/F, 35/F-43/F, 45/F-47/F 6樓-12樓, 15樓-23樓, 26樓-33樓, 35樓-43樓, 45樓-47樓								48/F 48樓								49/F 49樓		
		A	B	C	D	E	F	G	H	A	B	C	D	E	F	G	H	A	B	C	D	E	F	G	H	A	B	
Bathroom 2 浴室 2	Exposed Type 外露型	Lighting Point 燈位	--	--	--	--	--	--	--	--	--	--	--	--	--	--	--	--	--	--	--	--	--	--	--	4	4	
		13A Single Socket Outlet with USB 13安培單位電插座連USB	--	--	--	--	--	--	--	--	--	--	--	--	--	--	--	--	--	--	--	--	--	--	--	--	1	1
	Non-exposed Type 非外露型	Fused Spur Unit 菲士接線座	--	--	--	--	--	--	--	--	--	--	--	--	--	--	--	--	--	--	--	--	--	--	--	3	3	
Bathroom 3 浴室 3	Exposed Type 外露型	Lighting Point 燈位	--	--	--	--	--	--	--	--	--	--	--	--	--	--	--	--	--	--	--	--	--	--	--	4	4	
		13A Single Socket Outlet with USB 13安培單位電插座連USB	--	--	--	--	--	--	--	--	--	--	--	--	--	--	--	--	--	--	--	--	--	--	--	--	1	1
	Non-exposed Type 非外露型	Fused Spur Unit 菲士接線座	--	--	--	--	--	--	--	--	--	--	--	--	--	--	--	--	--	--	--	--	--	--	--	3	5	
Utility Room 工作間	Exposed Type 外露型	Lighting Switch 燈掣	--	--	3	1	--	1	1	--	--	--	3	1	--	1	1	--	--	--	1	1	--	1	1	--	3	3
		Lighting Point 燈位	--	--	1	1	--	1	1	--	--	--	1	1	--	1	1	--	--	--	1	1	--	1	1	--	1	1
		13A Single Socket Outlet 13安培單位電插座	--	--	2	2	--	2	2	--	--	--	2	2	--	2	2	--	--	--	2	2	--	2	2	--	3	3
		Telephone Outlet 電話插座	--	--	--	--	--	--	--	--	--	--	--	--	--	--	--	--	--	--	--	--	--	--	--	--	1	1
		RJ45 Outlet RJ45插座	--	--	--	--	--	--	--	--	--	--	--	--	--	--	--	--	--	--	--	--	--	--	--	--	1	1
		Switch for Air Conditioning Unit 冷氣機開關掣	--	--	1	--	--	--	--	--	--	--	--	1	--	--	--	--	--	--	1	--	--	--	--	--	1	1
		Miniature Circuit Breakers Board 總電掣箱	--	--	1	1	--	1	1	--	--	--	1	1	--	1	1	--	--	--	1	1	--	1	1	--	1	1
	Fibre Cable Point 光纖點位	--	--	--	--	--	--	--	--	--	--	--	--	--	--	--	--	--	--	--	--	--	--	--	--	1	1	
Non-exposed Type 非外露型	Fused Spur Unit 菲士接線座	--	--	--	--	--	--	--	--	--	--	--	--	--	--	--	--	--	--	--	--	--	--	--	--	1		

Notes:

1. "1, 2," denotes the quantity of such provision(s) provided in the residential property.
2. The symbol "--" as shown in the above table denotes "Not provided".
3. 4/F, 13/F, 14/F, 24/F, 34/F & 44/F are omitted. 25/F is refuge floor.
4. The vendor undertakes that if lifts or appliances of the specified brand name or model number are not installed in the Development, lifts or appliances of comparable quality will be installed.
5. Non-exposed type socket outlet/power connection unit may be covered or hidden by false ceilings, bulk-heads, cabinets, claddings, non-concrete partition walls, designated pipe ducts or other materials.

備註:

1. "1, 2," 表示提供於該住宅物業內的裝置數量。
2. 上表「--」代表「不提供」。
3. 不設4樓、13樓、14樓、24樓、34樓及44樓。25樓為隔火層。
4. 賣方承諾如發展項目中沒有安裝指明的品牌名稱或產品型號的升降機或設備，便會安裝品質相若的升降機或設備。
5. 非外露型電插座/電力接線座可能被假天花、假陣、貯存櫃、覆面、非混凝土間牆、指定之槽位或其他物料遮蓋。

SCHEDULE FOR LOCATION AND NUMBER OF MECHANICAL AND ELECTRICAL PROVISIONS OF RESIDENTIAL UNITS (TOWER 2) 住宅單位機電裝置位置及數量說明表 (第2座)

Location 位置	Description 描述		5/F 5樓								6/F-12/F, 15/F-23/F, 26/F-33/F, 35/F-43/F, 45/F-47/F 6樓-12樓, 15樓-23樓, 26樓-33樓, 35樓-43樓, 45樓-47樓								48/F 48樓								49/F 49樓	
			A	B	C	D	E	F	G	H	A	B	C	D	E	F	G	H	A	B	C	D	E	F	G	H	A	B
Lavatory inside Utility Room 工作間內之洗 手間	Exposed Type 外露型	Lighting Point 燈位	--	--	1	--	--	--	--	--	--	--	1	--	--	--	--	--	--	--	1	--	--	--	--	--	1	1
	Non-exposed Type 非外露型	Fused Spur Unit 菲士接線座	--	--	1	--	--	--	--	--	--	--	1	--	--	--	--	--	--	--	1	--	--	--	--	--	1	--
Store Room 儲物室	Exposed Type 外露型	Lighting Switch 燈掣	--	--	--	--	--	--	--	--	--	--	--	--	--	--	--	--	--	--	--	--	--	--	--	--	1	1
		Lighting Point 燈位	--	--	--	--	--	--	--	--	--	--	--	--	--	--	--	--	--	--	--	--	--	--	--	--	1	1
		13A Single Socket Outlet 13安培單位電插座	--	--	--	--	--	--	--	--	--	--	--	--	--	--	--	--	--	--	--	--	--	--	--	--	1	1
		Fused Spur Unit 菲士接線座	--	--	--	--	--	--	--	--	--	--	--	--	--	--	--	--	--	--	--	--	--	--	--	--	2	--
Staircase 樓梯	Exposed Type 外露型	Lighting Switch 燈掣	--	--	--	--	--	--	--	--	--	--	--	--	--	--	--	--	--	--	--	--	--	--	--	3	2	
		Lighting Point 燈位	--	--	--	--	--	--	--	--	--	--	--	--	--	--	--	--	--	--	--	--	--	--	--	--	2	2
		13A Single Socket Outlet 13安培單位電插座	--	--	--	--	--	--	--	--	--	--	--	--	--	--	--	--	--	--	--	--	--	--	--	--	1	--
Balcony 露台	Exposed Type 外露型	Balcony Light 露台燈	--	--	--	--	--	--	--	--	1	1	1	1	1	1	1	1	1	1	1	1	1	1	1	1	--	--
	Non-exposed Type 非外露型	Fused Spur Unit 菲士接線座	--	--	--	--	--	--	--	--	1	1	--	--	--	1	--	1	1	1	--	--	--	--	--	1	--	--

Notes:

- “1, 2, ……” denotes the quantity of such provision(s) provided in the residential property.
- The symbol "--" as shown in the above table denotes "Not provided".
- 4/F, 13/F, 14/F, 24/F, 34/F & 44/F are omitted. 25/F is refuge floor.
- The vendor undertakes that if lifts or appliances of the specified brand name or model number are not installed in the Development, lifts or appliances of comparable quality will be installed.
- Non-exposed type socket outlet/power connection unit may be covered or hidden by false ceilings, bulk-heads, cabinets, claddings, non-concrete partition walls, designated pipe ducts or other materials.

備註:

- “1, 2, ……” 表示提供於該住宅物業內的裝置數量。
- 上表「--」代表「不提供」。
- 不設4樓、13樓、14樓、24樓、34樓及44樓。25樓為隔火層。
- 賣方承諾如發展項目中沒有安裝指明的品牌名稱或產品型號的升降機或設備，便會安裝品質相若的升降機或設備。
- 非外露形電插座/電力接線座可能被假天花、假陣、貯存櫃、覆面、非混凝土間牆、指定之槽位或其他物料遮蓋。

SCHEDULE FOR LOCATION AND NUMBER OF MECHANICAL AND ELECTRICAL PROVISIONS OF RESIDENTIAL UNITS (TOWER 2) 住宅單位機電裝置位置及數量說明表 (第2座)

Location 位置	Description 描述	5/F 5樓								6/F-12/F, 15/F-23/F, 26/F-33/F, 35/F-43/F, 45/F-47/F 6樓-12樓, 15樓-23樓, 26樓-33樓, 35樓-43樓, 45樓-47樓								48/F 48樓								49/F 49樓		
		A	B	C	D	E	F	G	H	A	B	C	D	E	F	G	H	A	B	C	D	E	F	G	H	A	B	
Utility Platform 工作平台	Exposed Type 外露型	Lighting Switch 燈掣	--	--	--	--	--	--	--	--	--	--	--	--	--	--	--	--	--	--	1	--	--	--	--	--	--	
		Utility Platform Light 工作平台燈	--	--	--	--	--	--	--	--	--	1	1	1	1	1	1	--	--	1	1	1	1	1	1	--	1	1
	Non-exposed Type 非外露型	Fused Spur Unit 菲士接線座	--	--	--	--	--	--	--	--	--	--	1	1	1	--	--	--	--	--	1	1	1	--	--	--	--	
Flat Roof 平台	Exposed Type 外露型	Lighting Point 燈位	6	7	9	12	8	14	9	6	--	--	--	--	--	--	--	--	--	--	--	--	--	--	--	--	2	2
		13A Weatherproof Single Socket Outlet 13安培防水單位電插座	2	2	3	2	2	2	3	1	--	--	--	--	--	--	--	--	--	--	--	--	--	--	--	--	1	1
		Fused Spur Unit 菲士接線座	1	1	--	1	1	1	--	1	--	--	--	--	--	--	--	--	--	--	--	--	--	--	--	--	--	--
Private Roof 私人天台	Exposed Type 外露型	Weatherproof Lighting Switch 防水燈掣	--	--	--	--	--	--	--	--	--	--	--	--	--	--	--	--	--	--	1	1	--	--	--	--	--	
		Lighting Point 燈位	--	--	--	--	--	--	--	--	--	--	--	--	--	--	--	--	--	--	--	6	5	--	--	--	9	13
		13A Weatherproof Single Socket Outlet 13安培防水單位電插座	--	--	--	--	--	--	--	--	--	--	--	--	--	--	--	--	--	--	--	2	2	--	--	--	4	4
	Non-exposed Type 非外露型	Fused Spur Unit 菲士接線座	--	--	--	--	--	--	--	--	--	--	--	--	--	--	--	--	--	--	--	--	--	--	--	--	1	1
		13A Weatherproof Single Socket Outlet 13安培防水單位電插座	--	--	--	--	--	--	--	--	--	--	--	--	--	--	--	--	--	--	--	1	1	--	--	--	1	1
		Weatherproof RJ45 Outlet RJ45防水插座	--	--	--	--	--	--	--	--	--	--	--	--	--	--	--	--	--	--	--	--	--	--	--	--	1	1
		Jacuzzi Weatherproof Isolator 按摩浴缸防水開關掣	--	--	--	--	--	--	--	--	--	--	--	--	--	--	--	--	--	--	--	--	--	--	--	--	1	1
Air-Conditioner Platform 空調機平台	Exposed Type 外露型	A/C Unit Weatherproof Isolator 空調機防水開關掣	1	1	3	3	2	3	3	1	1	1	3	3	2	3	3	1	1	1	3	3	2	3	3	1	3	5

Notes:

1. "1, 2," denotes the quantity of such provision(s) provided in the residential property.
2. The symbol "--" as shown in the above table denotes "Not provided".
3. 4/F, 13/F, 14/F, 24/F, 34/F & 44/F are omitted. 25/F is refuge floor.
4. The vendor undertakes that if lifts or appliances of the specified brand name or model number are not installed in the Development, lifts or appliances of comparable quality will be installed.
5. Non-exposed type socket outlet/power connection unit may be covered or hidden by false ceilings, bulkheads, cabinets, claddings, non-concrete partition walls, designated pipe ducts or other materials.

備註:

1. "1, 2," 表示提供於該住宅物業內的裝置數量。
2. 上表「--」代表「不提供」。
3. 不設4樓、13樓、14樓、24樓、34樓及44樓。25樓為隔火層。
4. 賣方承諾如發展項目中沒有安裝指明的品牌名稱或產品型號的升降機或設備，便會安裝品質相若的升降機或設備。
5. 非外露形電插座/電力接線座可能被假天花、假陣、貯存櫃、覆面、非混凝土間牆、指定之槽位或其他物料遮蓋。

SCHEDULE FOR LOCATION AND NUMBER OF MECHANICAL AND ELECTRICAL PROVISIONS OF RESIDENTIAL UNITS (TOWER 3) 住宅單位機電裝置位置及數量說明表 (第3座)

Location 位置	Description 描述	5/F 5樓										6/F-12/F, 15/F-23/F, 26/F-33/F, 35/F-43/F, 45/F-49/F 6樓-12樓, 15樓-23樓, 26樓-33樓, 35樓-43樓, 45樓-49樓										50/F & 51/F (Duplex Unit) 50樓及 51樓 (複式單位)		50/F 50樓				51/F 51樓			
		A	B	C	D	E	F	G	H	J	A	B	C	D	E	F	G	H	J	A	B	C	D	E	F	C	D	E	F		
Master Bedroom 主人睡房	Exposed Type 外露型	Lighting Switch 燈掣	1	1	5	2	4	4	4	5	2	1	2	5	2	4	4	4	5	2	5	5	5	4	5	2	4	4	5	2	
		Lighting Point 燈位	1	2	2	1	1	1	1	1	1	1	2	2	1	1	1	1	1	1	2	3	1	1	1	1	1	1	1	1	
		13A Twin Socket Outlet 13安培雙位電插座	1	1	1	1	1	1	1	1	1	1	1	1	1	1	1	1	1	1	1	2	1	1	1	1	1	1	1	1	
		13A Single Socket Outlet 13安培單位電插座	1	1	1	1	--	--	--	1	1	1	1	1	1	--	--	--	1	1	2	1	1	--	2	1	1	--	2	1	
		13A Single Socket Outlet with USB 13安培單位電插座連USB	1	1	1	1	1	1	1	1	1	1	1	1	1	1	1	1	1	1	1	1	1	1	1	1	1	1	1	1	
		Switch for Air Conditioning Unit 冷氣機開關掣	1	1	1	1	1	1	1	1	1	1	1	1	1	1	1	1	1	1	2	1	1	1	1	1	1	1	1	1	
		TV/FM Outlet 電視/電台天線插座	1	1	1	1	1	1	1	1	1	1	1	1	1	1	1	1	1	1	1	1	1	1	1	1	1	1	1	1	
		Telephone Outlet 電話插座	1	1	1	1	1	1	1	1	1	1	1	1	1	1	1	1	1	1	1	1	1	1	1	1	1	1	1	1	
RJ45 Outlet RJ45插座	--	--	--	--	--	--	--	--	--	--	--	--	--	--	--	--	--	--	1	1	1	--	1	--	1	--	1	--			
Bedroom 1 睡房 1	Exposed Type 外露型	Lighting Switch 燈掣	1	1	1	1	--	--	--	1	1	1	1	1	1	--	--	--	1	1	1	4	1	--	1	1	1	--	1	1	
		Lighting Point 燈位	1	1	1	1	--	--	--	1	1	1	1	1	1	--	--	--	1	1	1	1	1	--	1	1	1	--	1	1	
		13A Twin Socket Outlet 13安培雙位電插座	--	--	--	--	--	--	--	--	--	--	--	--	--	--	--	--	--	--	1	1	1	--	1	--	1	--	1	--	
		13A Single Socket Outlet 13安培單位電插座	1	1	1	1	--	--	--	1	1	1	1	1	1	--	--	--	1	1	2	1	--	--	--	1	--	--	--	1	
		13A Single Socket Outlet with USB 13安培單位電插座連USB	1	1	1	1	--	--	--	1	1	1	1	1	1	--	--	--	1	1	1	1	1	--	1	1	1	--	1	1	
		Switch for Air Conditioning Unit 冷氣機開關掣	1	1	1	1	--	--	--	1	1	1	1	1	1	--	--	--	1	1	1	1	1	--	1	1	1	--	1	1	
		TV/FM Outlet 電視/電台天線插座	--	--	--	--	--	--	--	--	--	--	--	--	--	--	--	--	--	--	1	1	1	--	1	--	1	--	1	--	
		Telephone Outlet 電話插座	1	1	1	1	--	--	--	1	1	1	1	1	1	--	--	--	1	1	1	1	1	--	1	1	1	--	1	1	

Notes:

- "1, 2," denotes the quantity of such provision(s) provided in the residential property.
- The symbol "--" as shown in the above table denotes "Not provided".
- 4/F, 13/F, 14/F, 24/F, 34/F & 44/F are omitted. 25/F is refuge floor.
- The vendor undertakes that if lifts or appliances of the specified brand name or model number are not installed in the Development, lifts or appliances of comparable quality will be installed.
- Non-exposed type socket outlet/power connection unit may be covered or hidden by false ceilings, bulkheads, cabinets, claddings, non-concrete partition walls, designated pipe ducts or other materials.

備註:

- "1, 2," 表示提供於該住宅物業內的裝置數量。
- 上表「--」代表「不提供」。
- 不設4樓、13樓、14樓、24樓、34樓及44樓。25樓為隔火層。
- 賣方承諾如發展項目中沒有安裝指明的品牌名稱或產品型號的升降機或設備，便會安裝品質相若的升降機或設備。
- 非外露型電插座/電力接線座可能被假天花、假陣、貯存櫃、覆面、非混凝土間牆、指定之槽位或其他物料遮蓋。

SCHEDULE FOR LOCATION AND NUMBER OF MECHANICAL AND ELECTRICAL PROVISIONS OF RESIDENTIAL UNITS (TOWER 3) 住宅單位機電裝置位置及數量說明表 (第3座)

Location 位置	Description 描述	5/F 5樓										6/F-12/F, 15/F-23/F, 26/F-33/F, 35/F-43/F, 45/F-49/F 6樓-12樓, 15樓-23樓, 26樓-33樓, 35樓-43樓, 45樓-49樓										50/F & 51/F (Duplex Unit) 50樓及 51樓 (複式單位)		50/F 50樓					51/F 51樓				
		A	B	C	D	E	F	G	H	J	A	B	C	D	E	F	G	H	J	A	B	C	D	E	F	C	D	E	F				
Bedroom 2 睡房 2	Exposed Type 外露型	Lighting Switch 燈掣	1	--	1	1	--	--	--	1	--	1	--	1	1	--	--	--	1	--	4	4	2	--	1	--	2	--	1	--			
		Lighting Point 燈位	1	--	2	1	--	--	--	1	--	1	--	2	1	--	--	--	1	--	3	3	1	--	1	--	1	--	1	--			
		13A Twin Socket Outlet 13安培雙位電插座	--	--	--	--	--	--	--	--	--	--	--	--	--	--	--	--	--	--	1	1	1	--	1	--	1	--	1	--			
		13A Single Socket Outlet 13安培單位電插座	1	--	1	1	--	--	--	1	--	1	--	1	1	--	--	--	1	--	2	2	2	--	1	--	2	--	1	--			
		13A Single Socket Outlet with USB 13安培單位電插座連USB	1	--	1	1	--	--	--	1	--	1	--	1	1	--	--	--	1	--	1	1	1	--	1	--	1	--	1	--			
		Switch for Air Conditioning Unit 冷氣機開關掣	1	--	1	1	--	--	--	1	--	1	--	1	1	--	--	--	1	--	1	1	1	--	1	--	1	--	1	--			
		TV/FM Outlet 電視/電台天線插座	--	--	--	--	--	--	--	--	--	--	--	--	--	--	--	--	--	--	1	1	1	--	1	--	1	--	1	--			
		Telephone Outlet 電話插座	1	--	1	1	--	--	--	1	--	1	--	1	1	--	--	--	1	--	1	1	1	--	1	--	1	--	1	--			
Bedroom 3 睡房 3	Exposed Type 外露型	Lighting Switch 燈掣	--	--	--	--	--	--	--	--	--	--	--	--	--	--	--	--	--	4	1	--	--	1	--	--	--	1	--				
		Lighting Point 燈位	--	--	--	--	--	--	--	--	--	--	--	--	--	--	--	--	--	2	1	--	--	1	--	--	--	1	--				
		13A Twin Socket Outlet 13安培雙位電插座	--	--	--	--	--	--	--	--	--	--	--	--	--	--	--	--	--	1	1	--	--	1	--	--	--	1	--				
		13A Single Socket Outlet 13安培單位電插座	--	--	--	--	--	--	--	--	--	--	--	--	--	--	--	--	--	2	--	--	--	--	--	--	--	--	--				
		13A Single Socket Outlet with USB 13安培單位電插座連USB	--	--	--	--	--	--	--	--	--	--	--	--	--	--	--	--	--	1	1	--	--	1	--	--	--	1	--				
		Switch for Air Conditioning Unit 冷氣機開關掣	--	--	--	--	--	--	--	--	--	--	--	--	--	--	--	--	--	1	1	--	--	1	--	--	--	1	--				
		TV/FM Outlet 電視/電台天線插座	--	--	--	--	--	--	--	--	--	--	--	--	--	--	--	--	--	1	1	--	--	1	--	--	--	1	--				
		Telephone Outlet 電話插座	--	--	--	--	--	--	--	--	--	--	--	--	--	--	--	--	--	1	1	--	--	1	--	--	--	1	--				

Notes:

- "1, 2," denotes the quantity of such provision(s) provided in the residential property.
- The symbol "--" as shown in the above table denotes "Not provided".
- 4/F, 13/F, 14/F, 24/F, 34/F & 44/F are omitted. 25/F is refuge floor.
- The vendor undertakes that if lifts or appliances of the specified brand name or model number are not installed in the Development, lifts or appliances of comparable quality will be installed.
- Non-exposed type socket outlet/power connection unit may be covered or hidden by false ceilings, bulkheads, cabinets, claddings, non-concrete partition walls, designated pipe ducts or other materials.

備註:

- "1, 2," 表示提供於該住宅物業內的裝置數量。
- 上表「--」代表「不提供」。
- 不設4樓、13樓、14樓、24樓、34樓及44樓。25樓為隔火層。
- 賣方承諾如發展項目中沒有安裝指明的品牌名稱或產品型號的升降機或設備，便會安裝品質相若的升降機或設備。
- 非外露形電插座/電力接線座可能被假天花、假陣、貯存櫃、覆面、非混凝土間牆、指定之槽位或其他物料遮蓋。

SCHEDULE FOR LOCATION AND NUMBER OF MECHANICAL AND ELECTRICAL PROVISIONS OF RESIDENTIAL UNITS (TOWER 3) 住宅單位機電裝置位置及數量說明表 (第3座)

Location 位置	Description 描述	5/F 5樓										6/F-12/F, 15/F-23/F, 26/F-33/F, 35/F-43/F, 45/F-49/F 6樓-12樓, 15樓-23樓, 26樓-33樓, 35樓-43樓, 45樓-49樓										50/F & 51/F (Duplex Unit) 50樓及 51樓 (複式單位)		50/F 50樓				51/F 51樓			
		A	B	C	D	E	F	G	H	J	A	B	C	D	E	F	G	H	J	A	B	C	D	E	F	C	D	E	F		
Kitchen/ Open Kitchen 廚房/開放式 廚房	Exposed Type 外露型	Lighting Switch 燈掣	--	1	--	--	--	--	--	--	--	--	1	--	--	--	--	--	--	--	--	--	--	--	--	--	--	--	--		
		Lighting Point 燈位	2	1	3	3	1	1	1	2	2	2	1	3	3	1	1	1	2	2	3	3	2	1	3	2	2	1	3	2	
		13A Twin Socket Outlet 13安培雙位電插座	1	1	1	1	1	1	1	1	1	1	1	1	1	1	1	1	1	1	2	2	2	1	2	1	2	1	2	1	
		13A Single Socket Outlet 13安培單位電插座	1	--	1	1	--	--	--	1	1	1	--	1	1	--	--	--	1	1	1	1	1	--	1	1	1	--	1	1	
	Non-exposed Type 非外露型	Fused Spur Unit 菲士接線座	8	3	8	6	3	3	3	7	7	8	3	8	6	3	3	3	7	7	8	7	7	3	8	7	7	3	8	7	
		13A Single Socket Outlet 13安培單位電插座	3	3	3	3	3	3	3	3	2	3	3	3	3	3	3	3	3	2	3	3	3	3	3	2	3	3	3	2	
		Stove Switch 焗爐開關掣	1	--	1	1	--	--	--	1	1	1	--	1	1	--	--	--	1	1	1	1	1	--	1	1	1	--	1	1	
		Electrical Cooker Switch 電煮食焗開關掣	--	1	--	--	1	1	1	--	--	--	1	--	--	1	1	1	--	--	--	--	--	1	--	--	--	1	--	--	
		Barbecue Grill Switch 燒烤爐開關掣	--	--	--	--	--	--	--	--	--	--	--	--	--	--	--	--	--	--	1	1	--	--	--	--	--	--	--	--	
		Connection Unit 接線座	1	1	1	1	1	1	1	1	1	1	1	1	1	1	1	1	1	1	2	2	1	1	1	1	1	1	1	1	1
		Door Bell 門鈴	1	1	1	1	1	1	1	1	1	1	1	1	1	1	1	1	1	1	1	1	1	1	1	1	1	1	1	1	1
		Drain Point For Washer Dryer 去水位供洗衣乾衣機	1	1	1	1	1	1	1	1	1	1	1	1	1	1	1	1	1	1	1	1	1	1	1	1	1	1	1	1	1
		Water Point For Washer Dryer 來水位供洗衣乾衣機	1	1	1	1	1	1	1	1	1	1	1	1	1	1	1	1	1	1	1	1	1	1	1	1	1	1	1	1	1

Notes:

- “1, 2,” denotes the quantity of such provision(s) provided in the residential property.
- The symbol "--" as shown in the above table denotes "Not provided".
- 4/F, 13/F, 14/F, 24/F, 34/F & 44/F are omitted. 25/F is refuge floor.
- The vendor undertakes that if lifts or appliances of the specified brand name or model number are not installed in the Development, lifts or appliances of comparable quality will be installed.
- Non-exposed type socket outlet/power connection unit may be covered or hidden by false ceilings, bulk-heads, cabinets, claddings, non-concrete partition walls, designated pipe ducts or other materials.

備註:

- “1, 2,” 表示提供於該住宅物業內的裝置數量。
- 上表「--」代表「不提供」。
- 不設4樓、13樓、14樓、24樓、34樓及44樓。25樓為隔火層。
- 賣方承諾如發展項目中沒有安裝指明的品牌名稱或產品型號的升降機或設備，便會安裝品質相若的升降機或設備。
- 非外露形電插座/電力接線座可能被假天花、假陣、貯存櫃、覆面、非混凝土間牆、指定之槽位或其他物料遮蓋。

SCHEDULE FOR LOCATION AND NUMBER OF MECHANICAL AND ELECTRICAL PROVISIONS OF RESIDENTIAL UNITS (TOWER 3) 住宅單位機電裝置位置及數量說明表 (第3座)

Location 位置	Description 描述	5/F 5樓										6/F-12/F, 15/F-23/F, 26/F-33/F, 35/F-43/F, 45/F-49/F 6樓-12樓, 15樓-23樓, 26樓-33樓, 35樓-43樓, 45樓-49樓										50/F & 51/F (Duplex Unit) 50樓及 51樓 (複式單位)		50/F 50樓						51/F 51樓			
		A	B	C	D	E	F	G	H	J	A	B	C	D	E	F	G	H	J	A	B	C	D	E	F	C	D	E	F				
Master Bathroom 主人浴室	Exposed Type 外露型	Lighting Point 燈位	--	--	4	--	--	--	--	4	--	--	--	4	--	--	--	--	4	--	6	4	4	--	4	--	4	--	4	--			
		13A Single Socket Outlet with USB 13安培單位電插座連USB	--	--	1	--	--	--	--	1	--	--	--	1	--	--	--	--	1	--	1	1	1	--	1	--	1	--	1	--			
		Thermo Ventilator Switch ⁶ 浴室寶開關掣 ⁶	--	--	1	--	--	--	--	1	--	--	--	1	--	--	--	--	1	--	1	1	1	--	1	--	1	--	1	--			
	Non-exposed Type 非外露型	Fused Spur Unit 菲士接線座	--	--	4	--	--	--	--	4	--	--	--	4	--	--	--	--	4	--	5	4	4	--	4	--	4	--	4	--			
		Connection Unit 接線座	--	--	1	--	--	--	--	1	--	--	--	1	--	--	--	--	1	--	1	1	1	--	1	--	1	--	1	--			
Bathroom 浴室 / Bathroom 1 浴室 1	Exposed Type 外露型	Lighting Point 燈位	4	5	4	5	4	4	4	4	4	4	5	4	5	4	4	4	4	4	4	4	4	4	4	4	4	4	4	4			
		13A Single Socket Outlet with USB 13安培單位電插座連USB	1	1	1	1	1	1	1	1	1	1	1	1	1	1	1	1	1	1	1	1	1	1	1	1	1	1	1	1			
		Thermo Ventilator Switch ⁶ 浴室寶開關掣 ⁶	1	1	1	1	1	1	1	1	1	1	1	1	1	1	1	1	1	1	1	--	1	1	1	1	1	1	1	1			
	Non-exposed Type 非外露型	Fused Spur Unit 菲士接線座	4	3	2	4	3	3	3	2	4	4	3	2	4	3	3	3	2	4	3	3	2	3	2	4	2	3	2	4			
		Connection Unit 接線座	1	1	1	1	1	1	1	1	1	1	1	1	1	1	1	1	1	1	1	--	1	1	1	1	1	1	1	1			
Bathroom 2 浴室 2	Exposed Type 外露型	Lighting Point 燈位	--	--	--	--	--	--	--	--	--	--	--	--	--	--	--	--	--	4	4	--	--	--	--	--	--	--	--				
		13A Single Socket Outlet with USB 13安培單位電插座連USB	--	--	--	--	--	--	--	--	--	--	--	--	--	--	--	--	--	--	1	1	--	--	--	--	--	--	--	--			
	Non-exposed Type 非外露型	Fused Spur Unit 菲士接線座	--	--	--	--	--	--	--	--	--	--	--	--	--	--	--	--	--	4	3	--	--	--	--	--	--	--	--				

Notes:

1. "1, 2," denotes the quantity of such provision(s) provided in the residential property.
2. The symbol "--" as shown in the above table denotes "Not provided".
3. 4/F, 13/F, 14/F, 24/F, 34/F & 44/F are omitted. 25/F is refuge floor.
4. The vendor undertakes that if lifts or appliances of the specified brand name or model number are not installed in the Development, lifts or appliances of comparable quality will be installed.
5. Non-exposed type socket outlet/power connection unit may be covered or hidden by false ceilings, bulk-heads, cabinets, claddings, non-concrete partition walls, designated pipe ducts or other materials.
6. Thermo ventilator switch may change to non-exposed type due to statutory requirement or power supply company requirement.

備註:

1. "1, 2," 表示提供於該住宅物業內的裝置數量。
2. 上表「--」代表「不提供」。
3. 不設4樓、13樓、14樓、24樓、34樓及44樓。25樓為隔火層。
4. 賣方承諾如發展項目中沒有安裝指明的品牌名稱或產品型號的升降機或設備，便會安裝品質相若的升降機或設備。
5. 非外露型電插座/電力接線座可能被假天花、假陣、貯存櫃、覆面、非混凝土間牆、指定之槽位或其他物料遮蓋。
6. 浴室寶開關掣可能更改為非外露型，視乎法定要求或電力供應公司要求。

SCHEDULE FOR LOCATION AND NUMBER OF MECHANICAL AND ELECTRICAL PROVISIONS OF RESIDENTIAL UNITS (TOWER 3) 住宅單位機電裝置位置及數量說明表 (第3座)

Location 位置	Description 描述	5/F 5樓										6/F-12/F, 15/F-23/F, 26/F-33/F, 35/F-43/F, 45/F-49/F 6樓-12樓, 15樓-23樓, 26樓-33樓, 35樓-43樓, 45樓-49樓										50/F & 51/F (Duplex Unit) 50樓及 51樓 (複式單位)		50/F 50樓						51/F 51樓			
		A	B	C	D	E	F	G	H	J	A	B	C	D	E	F	G	H	J	A	B	C	D	E	F	C	D	E	F				
Bathroom 3 浴室 3	Exposed Type 外露型	Lighting Point 燈位	--	--	--	--	--	--	--	--	--	--	--	--	--	--	--	--	--	--	4	5	--	--	--	--	--	--	--	--			
		13A Single Socket Outlet with USB 13安培單位電插座連USB	--	--	--	--	--	--	--	--	--	--	--	--	--	--	--	--	--	--	--	1	1	--	--	--	--	--	--	--	--		
		Thermo Ventilator Switch ⁶ 浴室寶開關掣 ⁶	--	--	--	--	--	--	--	--	--	--	--	--	--	--	--	--	--	--	--	--	1	--	--	--	--	--	--	--	--		
	Non-exposed Type 非外露型	Fused Spur Unit 菲士接線座	--	--	--	--	--	--	--	--	--	--	--	--	--	--	--	--	--	--	3	4	--	--	--	--	--	--	--	--			
		Connection Unit 接線座	--	--	--	--	--	--	--	--	--	--	--	--	--	--	--	--	--	--	--	--	1	--	--	--	--	--	--	--	--		

Notes:

- “1, 2,” denotes the quantity of such provision(s) provided in the residential property.
- The symbol "--" as shown in the above table denotes "Not provided".
- 4/F, 13/F, 14/F, 24/F, 34/F & 44/F are omitted. 25/F is refuge floor.
- The vendor undertakes that if lifts or appliances of the specified brand name or model number are not installed in the Development, lifts or appliances of comparable quality will be installed.
- Non-exposed type socket outlet/power connection unit may be covered or hidden by false ceilings, bulk-heads, cabinets, claddings, non-concrete partition walls, designated pipe ducts or other materials.
- Thermo ventilator switch may change to non-exposed type due to statutory requirement or power supply company requirement.

備註:

- “1, 2,” 表示提供於該住宅物業內的裝置數量。
- 上表「--」代表「不提供」。
- 不設4樓、13樓、14樓、24樓、34樓及44樓。25樓為隔火層。
- 賣方承諾如發展項目中沒有安裝指明的品牌名稱或產品型號的升降機或設備，便會安裝品質相若的升降機或設備。
- 非外露型電插座/電力接線座可能被假天花、假陣、貯存櫃、覆面、非混凝土間牆、指定之槽位或其他物料遮蓋。
- 浴室寶開關掣可能更改為非外露型，視乎法定要求或電力供應公司要求。

SCHEDULE FOR LOCATION AND NUMBER OF MECHANICAL AND ELECTRICAL PROVISIONS OF RESIDENTIAL UNITS (TOWER 3) 住宅單位機電裝置位置及數量說明表 (第3座)

Location 位置	Description 描述	5/F 5樓										6/F-12/F, 15/F-23/F, 26/F-33/F, 35/F-43/F, 45/F-49/F 6樓-12樓, 15樓-23樓, 26樓-33樓, 35樓-43樓, 45樓-49樓										50/F & 51/F (Duplex Unit) 50樓及 51樓 (複式單位)		50/F 50樓						51/F 51樓			
		A	B	C	D	E	F	G	H	J	A	B	C	D	E	F	G	H	J	A	B	C	D	E	F	C	D	E	F				
Family Room 家庭室 / Upper Floor Corridor 上層走廊	Exposed Type 外露型	Lighting Switch 燈掣	--	--	--	--	--	--	--	--	--	--	--	--	--	--	--	--	--	--	2	3	--	--	--	--	--	--	--	--			
		Lighting Point 燈位	--	--	--	--	--	--	--	--	--	--	--	--	--	--	--	--	--	--	--	5	6	--	--	--	--	--	--	--	--		
		13A Twin Socket Outlet 13安培雙位電插座	--	--	--	--	--	--	--	--	--	--	--	--	--	--	--	--	--	--	--	2	--	--	--	--	--	--	--	--	--		
		13A Single Socket Outlet 13安培單位電插座	--	--	--	--	--	--	--	--	--	--	--	--	--	--	--	--	--	--	--	1	1	--	--	--	--	--	--	--	--		
		Switch for Air Conditioning Unit 冷氣機開關掣	--	--	--	--	--	--	--	--	--	--	--	--	--	--	--	--	--	--	--	1	--	--	--	--	--	--	--	--	--		
		TV/FM Outlet 電視/電台天線插座	--	--	--	--	--	--	--	--	--	--	--	--	--	--	--	--	--	--	--	1	--	--	--	--	--	--	--	--	--		
		Telephone Outlet 電話插座	--	--	--	--	--	--	--	--	--	--	--	--	--	--	--	--	--	--	--	1	--	--	--	--	--	--	--	--	--		
	RJ45 Outlet RJ45插座	--	--	--	--	--	--	--	--	--	--	--	--	--	--	--	--	--	--	--	1	--	--	--	--	--	--	--	--	--			
	Non-exposed Type 非外露型	13A Single Socket Outlet 13安培單位電插座	--	--	--	--	--	--	--	--	--	--	--	--	--	--	--	--	--	--	1	1	--	--	--	--	--	--	--	--			
		RJ45 Outlet RJ45插座	--	--	--	--	--	--	--	--	--	--	--	--	--	--	--	--	--	--	--	1	1	--	--	--	--	--	--	--	--		
Utility Room (without lavatory) 工作間 (不附 設洗手間)	Exposed Type 外露型	Lighting Switch 燈掣	--	--	1	--	--	--	--	1	1	--	--	1	--	--	--	--	1	1	--	--	--	--	--	--	--	1	--	--	--	1	
		Lighting Point 燈位	--	--	1	--	--	--	--	1	1	--	--	1	--	--	--	--	1	1	--	--	--	--	--	--	--	1	--	--	--	1	
		13A Single Socket Outlet 13安培單位電插座	--	--	1	--	--	--	--	2	2	--	--	1	--	--	--	--	2	2	--	--	--	--	--	--	--	2	--	--	--	2	
		Switch for Air Conditioning Unit 冷氣機開關掣	--	--	--	--	--	--	--	--	--	--	--	--	--	--	--	--	--	--	--	--	--	--	--	--	--	--	1	--	--	--	1
		Miniature Circuit Breakers Board 總電掣箱	--	--	--	--	--	--	--	--	1	1	--	--	--	--	--	--	1	1	--	--	--	--	--	--	--	1	--	--	--	1	

Notes:

- "1, 2," denotes the quantity of such provision(s) provided in the residential property.
- The symbol "--" as shown in the above table denotes "Not provided".
- 4/F, 13/F, 14/F, 24/F, 34/F & 44/F are omitted. 25/F is refuge floor.
- The vendor undertakes that if lifts or appliances of the specified brand name or model number are not installed in the Development, lifts or appliances of comparable quality will be installed.
- Non-exposed type socket outlet/power connection unit may be covered or hidden by false ceilings, bulk-heads, cabinets, claddings, non-concrete partition walls, designated pipe ducts or other materials.

備註:

- "1, 2," 表示提供於該住宅物業內的裝置數量。
- 上表「--」代表「不提供」。
- 不設4樓、13樓、14樓、24樓、34樓及44樓。25樓為隔火層。
- 賣方承諾如發展項目中沒有安裝指明的品牌名稱或產品型號的升降機或設備，便會安裝品質相若的升降機或設備。
- 非外露形電插座/電力接線座可能被假天花、假陣、貯存櫃、覆面、非混凝土間牆、指定之槽位或其他物料遮蓋。

SCHEDULE FOR LOCATION AND NUMBER OF MECHANICAL AND ELECTRICAL PROVISIONS OF RESIDENTIAL UNITS (TOWER 3) 住宅單位機電裝置位置及數量說明表 (第3座)

Location 位置	Description 描述	5/F 5樓										6/F-12/F, 15/F-23/F, 26/F-33/F, 35/F-43/F, 45/F-49/F 6樓-12樓, 15樓-23樓, 26樓-33樓, 35樓-43樓, 45樓-49樓										50/F & 51/F (Duplex Unit) 50樓及 51樓 (複式單位)		50/F 50樓						51/F 51樓			
		A	B	C	D	E	F	G	H	J	A	B	C	D	E	F	G	H	J	A	B	C	D	E	F	C	D	E	F				
Utility Room (with lavatory) 工作間 (附設 洗手間)	Exposed Type 外露型	Lighting Switch 燈掣	--	--	3	--	--	--	--	--	--	--	--	3	--	--	--	--	--	--	3	3	3	--	3	--	3	--	3	--			
		Lighting Point 燈位	--	--	1	--	--	--	--	--	--	--	--	1	--	--	--	--	--	--	1	1	2	--	1	--	2	--	1	--			
		13A Single Socket Outlet 13安培單位電插座	--	--	2	--	--	--	--	--	--	--	--	2	--	--	--	--	--	--	3	3	2	--	2	--	2	--	2	--			
		Telephone Outlet 電話插座	--	--	--	--	--	--	--	--	--	--	--	--	--	--	--	--	--	--	1	1	--	--	--	--	--	--	--	--			
		RJ45 Outlet RJ45插座	--	--	--	--	--	--	--	--	--	--	--	--	--	--	--	--	--	--	1	1	--	--	--	--	--	--	--	--			
		Switch for Air Conditioning Unit 冷氣機開關掣	--	--	1	--	--	--	--	--	--	--	--	1	--	--	--	--	--	--	1	1	1	--	1	--	1	--	1	--			
		Miniature Circuit Breakers Board 總電掣箱	--	--	1	--	--	--	--	--	--	--	--	1	--	--	--	--	--	--	1	1	1	--	1	--	1	--	1	--			
	Fibre Cable Point 光纖點位	--	--	--	--	--	--	--	--	--	--	--	--	--	--	--	--	--	--	1	1	--	--	--	--	--	--	--	--				
Non-exposed Type 非外露型	Fused Spur Unit 菲士接線座	--	--	1	--	--	--	--	--	--	--	1	--	--	--	--	--	--	--	--	--	--	--	--	--	--	--	--	--				
Lavatory inside Utility Room 工作間內之洗 手間	Exposed Type 外露型	Lighting Point 燈位	--	--	1	--	--	--	--	--	--	1	--	--	--	--	--	--	--	--	--	1	--	1	--	1	--	1	--				
	Non-exposed Type 非外露型	Fused Spur Unit 菲士接線座	--	--	--	--	--	--	--	--	--	--	--	--	--	--	--	--	--	--	--	--	--	1	--	--	--	1	--				
Lavatory 1 洗手間 1	Exposed Type 外露型	Lighting Point 燈位	--	--	--	--	--	--	--	--	--	--	--	--	--	--	--	--	--	3	1	--	--	--	--	--	--	--	--				
	Non-exposed Type 非外露型	Fused Spur Unit 菲士接線座	--	--	--	--	--	--	--	--	--	--	--	--	--	--	--	--	--	2	1	--	--	--	--	--	--	--	--				
Lavatory 2 洗手間 2	Exposed Type 外露型	Lighting Point 燈位	--	--	--	--	--	--	--	--	--	--	--	--	--	--	--	--	--	1	2	--	--	--	--	--	--	--	--				
	Non-exposed Type 非外露型	Fused Spur Unit 菲士接線座	--	--	--	--	--	--	--	--	--	--	--	--	--	--	--	--	--	1	2	--	--	--	--	--	--	--	--				

Notes:

- "1, 2," denotes the quantity of such provision(s) provided in the residential property.
- The symbol "--" as shown in the above table denotes "Not provided".
- 4/F, 13/F, 14/F, 24/F, 34/F & 44/F are omitted. 25/F is refuge floor.
- The vendor undertakes that if lifts or appliances of the specified brand name or model number are not installed in the Development, lifts or appliances of comparable quality will be installed.
- Non-exposed type socket outlet/power connection unit may be covered or hidden by false ceilings, bulk-heads, cabinets, claddings, non-concrete partition walls, designated pipe ducts or other materials.

備註:

- "1, 2," 表示提供於該住宅物業內的裝置數量。
- 上表「--」代表「不提供」。
- 不設4樓、13樓、14樓、24樓、34樓及44樓。25樓為隔火層。
- 賣方承諾如發展項目中沒有安裝指明的品牌名稱或產品型號的升降機或設備，便會安裝品質相若的升降機或設備。
- 非外露形電插座/電力接線座可能被假天花、假陣、貯存櫃、覆面、非混凝土間牆、指定之槽位或其他物料遮蓋。

SCHEDULE FOR LOCATION AND NUMBER OF MECHANICAL AND ELECTRICAL PROVISIONS OF RESIDENTIAL UNITS (TOWER 3) 住宅單位機電裝置位置及數量說明表 (第3座)

Location 位置	Description 描述	5/F 5樓										6/F-12/F, 15/F-23/F, 26/F-33/F, 35/F-43/F, 45/F-49/F 6樓-12樓, 15樓-23樓, 26樓-33樓, 35樓-43樓, 45樓-49樓										50/F & 51/F (Duplex Unit) 50樓及 51樓 (複式單位)		50/F 50樓						51/F 51樓			
		A	B	C	D	E	F	G	H	J	A	B	C	D	E	F	G	H	J	A	B	C	D	E	F	C	D	E	F				
Store Room 儲物室	Exposed Type 外露型	Lighting Switch 燈掣	--	--	--	1	--	--	--	--	--	--	--	--	1	--	--	--	--	--	2 ⁶	1	--	--	--	--	--	--	--	--			
		Lighting Point 燈位	--	--	--	1	--	--	--	--	--	--	--	--	1	--	--	--	--	--	2 ⁶	1	--	--	--	--	--	--	--	--			
		Miniature Circuit Breakers Board 總電掣箱	--	--	--	1	--	--	--	--	--	--	--	--	1	--	--	--	--	--	--	--	--	--	--	--	--	--	--	--			
		13A Single Socket Outlet 13安培單位電插座	--	--	--	--	--	--	--	--	--	--	--	--	--	--	--	--	--	--	1 ⁶	1	--	--	--	--	--	--	--	--			
Staircase 樓梯	Exposed Type 外露型	Lighting Switch 燈掣	--	--	--	-	--	--	--	--	--	--	--	--	--	--	--	--	--	7	6	--	--	--	--	--	--	--	--				
		Lighting Point 燈位	--	--	--	-	--	--	--	--	--	--	--	--	--	--	--	--	--	--	7	4	--	--	--	--	--	--	--	--			
		13A Single Socket Outlet 13安培單位電插座	--	--	--	--	--	--	--	--	--	--	--	--	--	--	--	--	--	2	2	--	--	--	--	--	--	--	--	--			
Balcony 露台	Exposed Type 外露型	Balcony Light 露台燈	--	--	--	-	--	--	--	--	--	1	1	1	1	1	1	1	1	--	1	1	1	1	1	1	1	1	1				
		13A Weatherproof Single Socket Outlet 13安培防水單位電插座	--	--	--	--	--	--	--	--	--	--	--	--	--	--	--	--	--	--	--	--	1	--	--	--	1	--	--	--			
	Non-exposed Type 非外露型	Fused Spur Unit 菲士接線座	--	--	--	-	--	--	--	--	--	--	--	1	1	1	1	--	--	--	--	2	1	--	--	2	1	--	--				

Notes:

- “1, 2,” denotes the quantity of such provision(s) provided in the residential property.
- The symbol "--" as shown in the above table denotes "Not provided".
- 4/F, 13/F, 14/F, 24/F, 34/F & 44/F are omitted. 25/F is refuge floor.
- The vendor undertakes that if lifts or appliances of the specified brand name or model number are not installed in the Development, lifts or appliances of comparable quality will be installed.
- Non-exposed type socket outlet/power connection unit may be covered or hidden by false ceilings, bulk-heads, cabinets, claddings, non-concrete partition walls, designated pipe ducts or other materials.
- There are 2 numbers of store rooms in Unit A (Duplex Unit) on 50/F & 51/F. The number of mechanical and electrical provisions marked on this table are the total sum of mechanical and electrical provisions in these 2 store rooms.

備註:

- “1, 2,” 表示提供於該住宅物業內的裝置數量。
- 上表「--」代表「不提供」。
- 不設4樓、13樓、14樓、24樓、34樓及44樓。25樓為隔火層。
- 賣方承諾如發展項目中沒有安裝指明的品牌名稱或產品型號的升降機或設備，便會安裝品質相若的升降機或設備。
- 非外露形電插座/電力接線座可能被假天花、假陣、貯存櫃、覆面、非混凝土間牆、指定之槽位或其他物料遮蓋。
- 50樓及51樓A單位（複式單位）設有2間儲物室，此處機電裝置的數量為2間儲物室的總和。

SCHEDULE FOR LOCATION AND NUMBER OF MECHANICAL AND ELECTRICAL PROVISIONS OF RESIDENTIAL UNITS (TOWER 3) 住宅單位機電裝置位置及數量說明表 (第3座)

Location 位置	Description 描述	5/F 5樓										6/F-12/F, 15/F-23/F, 26/F-33/F, 35/F-43/F, 45/F-49/F 6樓-12樓, 15樓-23樓, 26樓-33樓, 35樓-43樓, 45樓-49樓										50/F & 51/F (Duplex Unit) 50樓及 51樓 (複式單位)		50/F 50樓				51/F 51樓			
		A	B	C	D	E	F	G	H	J	A	B	C	D	E	F	G	H	J	A	B	C	D	E	F	C	D	E	F		
Utility Platform 工作平台	Exposed Type 外露型	Utility Platform Light 工作平台燈	--	--	1	--	--	--	--	--	--	1	1	1	1	1	1	1	1	--	--	1	1	1	1	1	1	1	1		
	Non-exposed Type 非外露型	Fused Spur Unit 菲士接線座	--	--	--	--	--	--	--	--	--	--	1	--	--	--	--	--	--	--	--	--	--	--	--	--	--	--	--		
Flat Roof 平台	Exposed Type 外露型	Lighting Point 燈位	12	4	4	8	6	8	9	12	11	--	--	--	--	--	--	--	--	--	3	2	2	--	--	--	--	--	--		
		13A Weather Proof Single/Twin Socket Outlet 13安培防水單位/雙位電插座	3	1	2	2	2	2	2	2	3	--	--	--	--	--	--	--	--	--	1	--	--	--	--	--	--	--	--		
	Non-exposed Type 非外露型	Fused Spur Unit 菲士接線座	--	1	--	1	1	1	1	--	--	--	--	--	--	--	--	--	--	--	--	--	--	--	--	--	--	--	--		
Private Roof 私人天台	Exposed Type 外露型	Weatherproof Lighting Switch 防水燈掣	--	--	--	--	--	--	--	--	--	--	--	--	--	--	--	--	--	--	--	--	--	--	--	--	1	1	1	1	
		Lighting Point 燈位	--	--	--	--	--	--	--	--	--	--	--	--	--	--	--	--	--	--	8	6	--	--	--	--	8	2	10	8	
		13A Weatherproof Single Socket Outlet 13安培防水單位電插座	--	--	--	--	--	--	--	--	--	--	--	--	--	--	--	--	--	--	3	3	--	--	--	--	2	--	3	2	
	Non-exposed Type 非外露型	Fused Spur Unit 菲士接線座	--	--	--	--	--	--	--	--	--	--	--	--	--	--	--	--	--	--	1	2	--	--	--	--	--	--	--	--	
		13A Weatherproof Single Socket Outlet 13安培防水單位電插座	--	--	--	--	--	--	--	--	--	--	--	--	--	--	--	--	--	--	1	1	--	--	--	--	1	1	1	1	
		RJ45 Outlet RJ45插座	--	--	--	--	--	--	--	--	--	--	--	--	--	--	--	--	--	--	1	1	--	--	--	--	1	--	1	1	
		Jaccuzi Weatherproof Isolator 按摩浴缸防水開關掣	--	--	--	--	--	--	--	--	--	--	--	--	--	--	--	--	--	--	1	1	--	--	--	--	--	--	--	--	
Air-Conditioner Platform 空調機平台	Exposed Type 外露型	A/C Unit Weatherproof Isolator 空調機防水開關掣	3	2	3	2	1	1	1	3	2	3	2	3	2	1	1	1	3	2	7	6	2	1	5	3	4	1	5	2	

Notes:

- "1, 2," denotes the quantity of such provision(s) provided in the residential property.
- The symbol "--" as shown in the above table denotes "Not provided".
- 4/F, 13/F, 14/F, 24/F, 34/F & 44/F are omitted. 25/F is refuge floor.
- The vendor undertakes that if lifts or appliances of the specified brand name or model number are not installed in the Development, lifts or appliances of comparable quality will be installed.
- Non-exposed type socket outlet/power connection unit may be covered or hidden by false ceilings, bulk-heads, cabinets, claddings, non-concrete partition walls, designated pipe ducts or other materials.

備註:

- "1, 2," 表示提供於該住宅物業內的裝置數量。
- 上表「--」代表「不提供」。
- 不設4樓、13樓、14樓、24樓、34樓及44樓。25樓為隔火層。
- 賣方承諾如發展項目中沒有安裝指明的品牌名稱或產品型號的升降機或設備，便會安裝品質相若的升降機或設備。
- 非外露形電插座/電力接線座可能被假天花、假陣、貯存櫃、覆面、非混凝土間牆、指定之槽位或其他物料遮蓋。

SCHEDULE FOR LOCATION AND NUMBER OF MECHANICAL AND ELECTRICAL PROVISIONS OF RESIDENTIAL UNITS (TOWER 5) 住宅單位機電裝置位置及數量說明表 (第5座)

Location 位置	Description 描述	5/F 5樓										6/F-12/F, 15/F-23/F, 26/F-33/F, 35/F-43/F, 45/F-49/F 6樓-12樓, 15樓-23樓, 26樓-33樓, 35樓-43樓, 45樓-49樓										50/F & 51/F (Duplex Unit) 50樓及 51樓 (複式單位)		50/F 50樓				51/F 51樓			
		A	B	C	D	E	F	G	H	J	A	B	C	D	E	F	G	H	J	A	B	C	D	E	F	C	D	E	F		
Master Bedroom 主人睡房	Exposed Type 外露型	Lighting Switch 燈掣	1	1	5	2	4	4	4	2	3	1	1	5	2	4	4	4	2	2	4	5	2	4	5	2	2	4	5	2	
		Lighting Point 燈位	1	2	2	1	1	1	1	1	1	1	2	2	1	1	1	1	1	1	2	2	1	1	1	1	1	1	1	1	
		13A Twin Socket Outlet 13安培雙位電插座	1	1	1	1	1	1	1	1	1	1	1	1	1	1	1	1	1	1	1	2	1	1	1	1	1	1	1	1	
		13A Single Socket Outlet 13安培單位電插座	1	1	1	1	--	--	--	1	1	1	1	1	1	--	--	--	1	1	2	1	1	--	2	1	1	--	2	1	
		13A Single Socket Outlet with USB 13安培單位電插座連USB	1	1	1	1	1	1	1	1	1	1	1	1	1	1	1	1	1	1	1	1	1	1	1	1	1	1	1	1	
		Switch for Air Conditioning Unit 冷氣機開關掣	1	1	1	1	1	1	1	1	1	1	1	1	1	1	1	1	1	1	2	1	1	1	1	1	1	1	1	1	
		TV/FM Outlet 電視/電台天線插座	1	1	1	1	1	1	1	1	1	1	1	1	1	1	1	1	1	1	1	1	1	1	1	1	1	1	1	1	
		Telephone Outlet 電話插座	1	1	1	1	1	1	1	1	1	1	1	1	1	1	1	1	1	1	1	1	1	1	1	1	1	1	1	1	
		RJ45 Outlet RJ45插座	--	--	--	--	--	--	--	--	--	--	--	--	--	--	--	--	--	--	1	1	--	--	1	--	--	--	1	--	
Bedroom 1 睡房 1	Exposed Type 外露型	Lighting Switch 燈掣	1	1	1	1	--	--	--	1	1	1	1	1	1	--	--	--	1	1	1	4	1	--	1	1	1	--	1	1	
		Lighting Point 燈位	1	1	1	1	--	--	--	1	1	1	1	1	1	--	--	--	1	1	1	1	1	--	1	1	1	--	1	1	
		13A Twin Socket Outlet 13安培雙位電插座	--	--	--	--	--	--	--	--	--	--	--	--	--	--	--	--	--	--	1	1	--	--	1	--	--	--	1	--	
		13A Single Socket Outlet 13安培單位電插座	1	1	1	1	--	--	--	1	1	1	1	1	1	--	--	--	1	1	2	1	1	--	--	1	1	--	--	1	
		13A Single Socket Outlet with USB 13安培單位電插座連USB	1	1	1	1	--	--	--	1	1	1	1	1	1	--	--	--	1	1	1	1	1	--	1	1	1	--	1	1	
		Switch for Air Conditioning Unit 冷氣機開關掣	1	1	1	1	--	--	--	1	1	1	1	1	1	--	--	--	1	1	1	1	1	--	1	1	1	--	1	1	
		TV/FM Outlet 電視/電台天線插座	--	--	--	--	--	--	--	--	--	--	--	--	--	--	--	--	--	--	1	1	--	--	1	--	--	--	1	--	
		Telephone Outlet 電話插座	1	1	1	1	--	--	--	1	1	1	1	1	1	--	--	--	1	1	1	1	1	-	1	1	1	--	1	1	

Notes:

- "1, 2," denotes the quantity of such provision(s) provided in the residential property.
- The symbol "--" as shown in the above table denotes "Not provided".
- 4/F, 13/F, 14/F, 24/F, 34/F & 44/F are omitted. 25/F is refuge floor.
- The vendor undertakes that if lifts or appliances of the specified brand name or model number are not installed in the Development, lifts or appliances of comparable quality will be installed.
- Non-exposed type socket outlet/power connection unit may be covered or hidden by false ceilings, bulk-heads, cabinets, claddings, non-concrete partition walls, designated pipe ducts or other materials.

備註:

- "1, 2," 表示提供於該住宅物業內的裝置數量。
- 上表「--」代表「不提供」。
- 不設4樓、13樓、14樓、24樓、34樓及44樓。25樓為隔火層。
- 賣方承諾如發展項目中沒有安裝指明的品牌名稱或產品型號的升降機或設備，便會安裝品質相若的升降機或設備。
- 非外露形電插座/電力接線座可能被假天花、假陣、貯存櫃、覆面、非混凝土間牆、指定之槽位或其他物料遮蓋。

SCHEDULE FOR LOCATION AND NUMBER OF MECHANICAL AND ELECTRICAL PROVISIONS OF RESIDENTIAL UNITS (TOWER 5) 住宅單位機電裝置位置及數量說明表 (第5座)

Location 位置	Description 描述	5/F 5樓										6/F-12/F, 15/F-23/F, 26/F-33/F, 35/F-43/F, 45/F-49/F 6樓-12樓, 15樓-23樓, 26樓-33樓, 35樓-43樓, 45樓-49樓										50/F & 51/F (Duplex Unit) 50樓及 51樓 (複式單位)		50/F 50樓					51/F 51樓				
		A	B	C	D	E	F	G	H	J	A	B	C	D	E	F	G	H	J	A	B	C	D	E	F	C	D	E	F				
Bedroom 2 睡房 2	Exposed Type 外露型	Lighting Switch 燈掣	1	--	1	1	--	--	--	--	--	1	--	1	1	--	--	--	--	--	4	4	1	--	1	--	1	--	1	--			
		Lighting Point 燈位	1	--	2	1	--	--	--	--	--	1	--	2	1	--	--	--	--	--	3	3	1	--	1	--	1	--	1	--			
		13A Twin Socket Outlet 13安培雙位電插座	--	--	--	--	--	--	--	--	--	--	--	--	--	--	--	--	--	--	1	1	--	--	1	--	--	--	1	--			
		13A Single Socket Outlet 13安培單位電插座	1	--	1	1	--	--	--	--	--	1	--	1	1	--	--	--	--	--	2	2	1	--	--	--	1	--	--	--			
		13A Single Socket Outlet with USB 13安培單位電插座連USB	1	--	1	1	--	--	--	--	--	1	--	1	1	--	--	--	--	--	1	1	1	--	1	--	1	--	1	--			
		Switch for Air Conditioning Unit 冷氣機開關掣	1	--	1	1	--	--	--	--	--	1	--	1	1	--	--	--	--	--	1	1	1	--	1	--	1	--	1	--			
		TV/FM Outlet 電視/電台天線插座	--	--	--	--	--	--	--	--	--	--	--	--	--	--	--	--	--	--	1	1	--	--	1	--	--	--	1	--			
		Telephone Outlet 電話插座	1	--	1	1	--	--	--	--	--	1	--	1	1	--	--	--	--	--	1	1	1	--	1	--	1	--	1	--			
Bedroom 3 睡房 3	Exposed Type 外露型	Lighting Switch 燈掣	--	--	--	--	--	--	--	--	--	--	--	--	--	--	--	--	--	4	1	--	--	1	--	--	--	1	--				
		Lighting Point 燈位	--	--	--	--	--	--	--	--	--	--	--	--	--	--	--	--	--	--	2	1	--	--	1	--	--	--	1	--			
		13A Twin Socket Outlet 13安培雙位電插座	--	--	--	--	--	--	--	--	--	--	--	--	--	--	--	--	--	--	1	1	--	--	1	--	--	--	1	--			
		13A Single Socket Outlet 13安培單位電插座	--	--	--	--	--	--	--	--	--	--	--	--	--	--	--	--	--	--	2	--	--	--	1	--	--	--	1	--			
		13A Single Socket Outlet with USB 13安培單位電插座連USB	--	--	--	--	--	--	--	--	--	--	--	--	--	--	--	--	--	--	1	1	--	--	1	--	--	--	1	--			
		Switch for Air Conditioning Unit 冷氣機開關掣	--	--	--	--	--	--	--	--	--	--	--	--	--	--	--	--	--	--	1	1	--	--	1	--	--	--	1	--			
		TV/FM Outlet 電視/電台天線插座	--	--	--	--	--	--	--	--	--	--	--	--	--	--	--	--	--	--	1	1	--	--	1	--	--	--	1	--			
		Telephone Outlet 電話插座	--	--	--	--	--	--	--	--	--	--	--	--	--	--	--	--	--	--	1	1	--	--	1	--	--	--	1	--			

Notes:

- “1, 2,” denotes the quantity of such provision(s) provided in the residential property.
- The symbol "--" as shown in the above table denotes "Not provided".
- 4/F, 13/F, 14/F, 24/F, 34/F & 44/F are omitted. 25/F is refuge floor.
- The vendor undertakes that if lifts or appliances of the specified brand name or model number are not installed in the Development, lifts or appliances of comparable quality will be installed.
- Non-exposed type socket outlet/power connection unit may be covered or hidden by false ceilings, bulkheads, cabinets, claddings, non-concrete partition walls, designated pipe ducts or other materials.

備註:

- “1, 2,” 表示提供於該住宅物業內的裝置數量。
- 上表「--」代表「不提供」。
- 不設4樓、13樓、14樓、24樓、34樓及44樓。25樓為隔火層。
- 賣方承諾如發展項目中沒有安裝指明的品牌名稱或產品型號的升降機或設備，便會安裝品質相若的升降機或設備。
- 非外露形電插座/電力接線座可能被假天花、假陣、貯存櫃、覆面、非混凝土間牆、指定之槽位或其他物料遮蓋。

SCHEDULE FOR LOCATION AND NUMBER OF MECHANICAL AND ELECTRICAL PROVISIONS OF RESIDENTIAL UNITS (TOWER 5) 住宅單位機電裝置位置及數量說明表 (第5座)

Location 位置	Description 描述	5/F 5樓										6/F-12/F, 15/F-23/F, 26/F-33/F, 35/F-43/F, 45/F-49/F 6樓-12樓, 15樓-23樓, 26樓-33樓, 35樓-43樓, 45樓-49樓										50/F & 51/F (Duplex Unit) 50樓及 51樓 (複式單位)		50/F 50樓				51/F 51樓			
		A	B	C	D	E	F	G	H	J	A	B	C	D	E	F	G	H	J	A	B	C	D	E	F	C	D	E	F		
Kitchen/ Open Kitchen 廚房/開放式 廚房	Exposed Type 外露型	Lighting Switch 燈掣	--	1	--	--	--	--	--	--	--	--	1	--	--	--	--	--	--	--	--	--	--	--	--	--	--	--	--	--	
		Lighting Point 燈位	2	1	3	3	1	1	1	2	2	2	1	3	3	1	1	1	2	2	3	3	3	1	4	2	3	1	4	2	
		13A Twin Socket Outlet 13安培雙位電插座	1	1	1	1	1	1	1	1	1	1	1	1	1	1	1	1	1	1	2	2	1	1	3	1	1	1	3	1	
		13A Single Socket Outlet 13安培單位電插座	1	--	1	1	--	--	--	1	1	1	--	1	1	--	--	--	1	1	1	1	1	--	1	1	1	--	1	1	
	Non-exposed Type 非外露型	Fused Spur Unit 菲士接線座	8	3	8	6	3	3	3	7	7	8	3	8	6	3	3	3	7	7	8	7	6	3	8	7	6	3	8	7	
		13A Single Socket Outlet 13安培單位電插座	3	3	3	3	3	3	3	2	2	3	3	3	3	3	3	3	2	2	3	3	3	3	3	2	3	3	3	2	
		Stove Switch 焗爐開關掣	1	--	1	1	--	--	--	1	1	1	--	1	1	--	--	--	1	1	1	1	1	--	1	1	1	--	1	1	
		Electrical Cooker Switch 電煮食焗開關掣	--	1	--	--	1	1	1	--	--	--	1	--	--	1	1	1	--	--	--	--	--	1	--	--	--	1	--	--	
		Barbecue Grill Switch 燒烤爐開關掣	--	--	--	--	--	--	--	--	--	--	--	--	--	--	--	--	--	--	1	1	--	--	--	--	--	--	--	--	
		Connection Unit 接線座	1	1	1	1	1	1	1	1	1	1	1	1	1	1	1	1	1	1	2	2	1	1	1	1	1	1	1	1	1
		Door Bell 門鈴	1	1	1	1	1	1	1	1	1	1	1	1	1	1	1	1	1	1	1	1	1	1	1	1	1	1	1	1	1
		Drain Point For Washer Dryer 去水位供洗衣乾衣機	1	1	1	1	1	1	1	1	1	1	1	1	1	1	1	1	1	1	1	1	1	1	1	1	1	1	1	1	1
		Water Point For Washer Dryer 來水位供洗衣乾衣機	1	1	1	1	1	1	1	1	1	1	1	1	1	1	1	1	1	1	1	1	1	1	1	1	1	1	1	1	1

Notes:

1. "1, 2," denotes the quantity of such provision(s) provided in the residential property.
2. The symbol "--" as shown in the above table denotes "Not provided".
3. 4/F, 13/F, 14/F, 24/F, 34/F & 44/F are omitted. 25/F is refuge floor.
4. The vendor undertakes that if lifts or appliances of the specified brand name or model number are not installed in the Development, lifts or appliances of comparable quality will be installed.
5. Non-exposed type socket outlet/power connection unit may be covered or hidden by false ceilings, bulk-heads, cabinets, claddings, non-concrete partition walls, designated pipe ducts or other materials.

備註:

1. "1, 2," 表示提供於該住宅物業內的裝置數量。
2. 上表「--」代表「不提供」。
3. 不設4樓、13樓、14樓、24樓、34樓及44樓。25樓為隔火層。
4. 賣方承諾如發展項目中沒有安裝指明的品牌名稱或產品型號的升降機或設備，便會安裝品質相若的升降機或設備。
5. 非外露形電插座/電力接線座可能被假天花、假陣、貯存櫃、覆面、非混凝土間牆、指定之槽位或其他物料遮蓋。

SCHEDULE FOR LOCATION AND NUMBER OF MECHANICAL AND ELECTRICAL PROVISIONS OF RESIDENTIAL UNITS (TOWER 5) 住宅單位機電裝置位置及數量說明表 (第5座)

Location 位置	Description 描述	5/F 5樓										6/F-12/F, 15/F-23/F, 26/F-33/F, 35/F-43/F, 45/F-49/F 6樓-12樓, 15樓-23樓, 26樓-33樓, 35樓-43樓, 45樓-49樓										50/F & 51/F (Duplex Unit) 50樓及 51樓 (複式單位)		50/F 50樓						51/F 51樓			
		A	B	C	D	E	F	G	H	J	A	B	C	D	E	F	G	H	J	A	B	C	D	E	F	C	D	E	F				
Master Bathroom 主人浴室	Exposed Type 外露型	Lighting Point 燈位	--	--	4	--	--	--	--	--	--	--	--	4	--	--	--	--	--	--	6	4	--	--	4	--	--	--	4	--			
		13A Single Socket Outlet with USB 13安培單位電插座連USB	--	--	1	--	--	--	--	--	--	--	--	1	--	--	--	--	--	--	1	1	--	--	1	--	--	--	1	--			
		Thermo Ventilator Switch ⁶ 浴室寶開關掣 ⁶	--	--	1	--	--	--	--	--	--	--	--	1	--	--	--	--	--	--	1	1	--	--	1	--	--	--	1	--			
	Non-exposed Type 非外露型	Fused Spur Unit 菲士接線座	--	--	4	--	--	--	--	--	--	--	4	--	--	--	--	--	--	5	4	--	--	4	--	--	--	4	--				
		Connection Unit 接線座	--	--	1	--	--	--	--	--	--	--	1	--	--	--	--	--	--	1	1	--	--	1	--	--	--	1	--				
Bathroom 浴室	Exposed Type 外露型	Lighting Point 燈位	4	5	4	5	4	4	4	4	4	4	5	4	5	4	4	4	4	4	--	4	5	4	4	4	5	4	4	4			
		13A Single Socket Outlet with USB 13安培單位電插座連USB	1	1	1	1	1	1	1	1	1	1	1	1	1	1	1	1	1	1	--	1	1	1	1	1	1	1	1	1			
		Thermo Ventilator Switch ⁶ 浴室寶開關掣 ⁶	1	1	1	1	1	1	1	1	1	1	1	1	1	1	1	1	1	1	--	--	1	1	1	1	1	1	1	1			
	Non-exposed Type 非外露型	Fused Spur Unit 菲士接線座	4	3	2	4	3	3	3	4	4	4	3	2	4	3	3	3	4	4	--	3	4	3	3	4	4	3	3	4			
		Connection Unit 接線座	1	1	1	1	1	1	1	1	1	1	1	1	1	1	1	1	1	1	--	1	1	1	1	1	1	1	1	1			
Bathroom 1 浴室 1	Exposed Type 外露型	Lighting Point 燈位	--	--	--	--	--	--	--	--	--	--	--	--	--	--	--	--	--	4	4	--	--	--	--	--	--	--	--				
		13A Single Socket Outlet with USB 13安培單位電插座連USB	--	--	--	--	--	--	--	--	--	--	--	--	--	--	--	--	--	--	1	1	--	--	--	--	--	--	--	--			
		Thermo Ventilator Switch ⁶ 浴室寶開關掣 ⁶	--	--	--	--	--	--	--	--	--	--	--	--	--	--	--	--	--	--	1	1	--	--	--	--	--	--	--	--			
	Non-exposed Type 非外露型	Fused Spur Unit 菲士接線座	--	--	--	--	--	--	--	--	--	--	--	--	--	--	--	--	--	3	3	--	--	--	--	--	--	--	--				
		Connection Unit 接線座	--	--	--	--	--	--	--	--	--	--	--	--	--	--	--	--	--	1	1	--	--	--	--	--	--	--	--				

Notes:

- "1, 2," denotes the quantity of such provision(s) provided in the residential property.
- The symbol "--" as shown in the above table denotes "Not provided".
- 4/F, 13/F, 14/F, 24/F, 34/F & 44/F are omitted. 25/F is refuge floor.
- The vendor undertakes that if lifts or appliances of the specified brand name or model number are not installed in the Development, lifts or appliances of comparable quality will be installed.
- Non-exposed type socket outlet/power connection unit may be covered or hidden by false ceilings, bulk-heads, cabinets, claddings, non-concrete partition walls, designated pipe ducts or other materials.
- Thermo ventilator switch may change to non-exposed type due to statutory requirement or power supply company requirement.

備註:

- "1, 2," 表示提供於該住宅物業內的裝置數量。
- 上表「--」代表「不提供」。
- 不設4樓、13樓、14樓、24樓、34樓及44樓。25樓為隔火層。
- 賣方承諾如發展項目中沒有安裝指明的品牌名稱或產品型號的升降機或設備，便會安裝品質相若的升降機或設備。
- 非外露型電插座/電力接線座可能被假天花、假陣、貯存櫃、覆面、非混凝土間牆、指定之槽位或其他物料遮蓋。
- 浴室寶開關掣可能更改為非外露型，視乎法定要求或電力供應公司要求。

SCHEDULE FOR LOCATION AND NUMBER OF MECHANICAL AND ELECTRICAL PROVISIONS OF RESIDENTIAL UNITS (TOWER 5) 住宅單位機電裝置位置及數量說明表 (第5座)

Location 位置	Description 描述	5/F 5樓										6/F-12/F, 15/F-23/F, 26/F-33/F, 35/F-43/F, 45/F-49/F 6樓-12樓, 15樓-23樓, 26樓-33樓, 35樓-43樓, 45樓-49樓										50/F & 51/F (Duplex Unit) 50樓及 51樓 (複式單位)		50/F 50樓						51/F 51樓					
		A	B	C	D	E	F	G	H	J	A	B	C	D	E	F	G	H	J	A	B	C	D	E	F	C	D	E	F						
Bathroom 2 浴室 2	Exposed Type 外露型	Lighting Point 燈位	--	--	--	--	--	--	--	--	--	--	--	--	--	--	--	--	--	4	4	--	--	--	--	--	--	--	--						
		13A Single Socket Outlet with USB 13安培單位電插座連USB	--	--	--	--	--	--	--	--	--	--	--	--	--	--	--	--	--	--	1	1	--	--	--	--	--	--	--	--					
	Non-exposed Type 非外露型	Fused Spur Unit 菲士接線座	--	--	--	--	--	--	--	--	--	--	--	--	--	--	--	--	--	4	3	--	--	--	--	--	--	--	--						
Bathroom 3 浴室 3	Exposed Type 外露型	Lighting Point 燈位	--	--	--	--	--	--	--	--	--	--	--	--	--	--	--	--	--	4	5	--	--	--	--	--	--	--	--						
		13A Single Socket Outlet with USB 13安培單位電插座連USB	--	--	--	--	--	--	--	--	--	--	--	--	--	--	--	--	--	--	1	1	--	--	--	--	--	--	--	--					
		Thermo Ventilator Switch ⁶ 浴室寶開關掣 ⁶	--	--	--	--	--	--	--	--	--	--	--	--	--	--	--	--	--	--	--	1	--	--	--	--	--	--	--	--					
	Non-exposed Type 非外露型	Fused Spur Unit 菲士接線座	--	--	--	--	--	--	--	--	--	--	--	--	--	--	--	--	--	3	4	--	--	--	--	--	--	--	--						
		Connection Unit 接線座	--	--	--	--	--	--	--	--	--	--	--	--	--	--	--	--	--	--	--	1	--	--	--	--	--	--	--	--					

Notes:

- "1, 2," denotes the quantity of such provision(s) provided in the residential property.
- The symbol "--" as shown in the above table denotes "Not provided".
- 4/F, 13/F, 14/F, 24/F, 34/F & 44/F are omitted. 25/F is refuge floor.
- The vendor undertakes that if lifts or appliances of the specified brand name or model number are not installed in the Development, lifts or appliances of comparable quality will be installed.
- Non-exposed type socket outlet/power connection unit may be covered or hidden by false ceilings, bulk-heads, cabinets, claddings, non-concrete partition walls, designated pipe ducts or other materials.
- Thermo ventilator switch may change to non-exposed type due to statutory requirement or power supply company requirement.

備註:

- "1, 2," 表示提供於該住宅物業內的裝置數量。
- 上表「--」代表「不提供」。
- 不設4樓、13樓、14樓、24樓、34樓及44樓。25樓為隔火層。
- 賣方承諾如發展項目中沒有安裝指明的品牌名稱或產品型號的升降機或設備，便會安裝品質相若的升降機或設備。
- 非外露型電插座/電力接線座可能被假天花、假陣、貯存櫃、覆面、非混凝土間牆、指定之槽位或其他物料遮蓋。
- 浴室寶開關掣可能更改為非外露型，視乎法定要求或電力供應公司要求。

SCHEDULE FOR LOCATION AND NUMBER OF MECHANICAL AND ELECTRICAL PROVISIONS OF RESIDENTIAL UNITS (TOWER 5) 住宅單位機電裝置位置及數量說明表 (第5座)

Location 位置	Description 描述	5/F 5樓										6/F-12/F, 15/F-23/F, 26/F-33/F, 35/F-43/F, 45/F-49/F 6樓-12樓, 15樓-23樓, 26樓-33樓, 35樓-43樓, 45樓-49樓										50/F & 51/F (Duplex Unit) 50樓及 51樓 (複式單位)		50/F 50樓						51/F 51樓			
		A	B	C	D	E	F	G	H	J	A	B	C	D	E	F	G	H	J	A	B	C	D	E	F	C	D	E	F				
Family Room 家庭室 / Upper Floor Corridor 上層走廊	Exposed Type 外露型	Lighting Switch 燈掣	--	--	--	--	--	--	--	--	--	--	--	--	--	--	--	--	--	--	2	3	--	--	--	--	--	--	--	--	--	--	
		Lighting Point 燈位	--	--	--	--	--	--	--	--	--	--	--	--	--	--	--	--	--	--	--	5	6	--	--	--	--	--	--	--	--	--	--
		13A Twin Socket Outlet 13安培雙位電插座	--	--	--	--	--	--	--	--	--	--	--	--	--	--	--	--	--	--	--	2	--	--	--	--	--	--	--	--	--	--	--
		13A Single Socket Outlet 13安培單位電插座	--	--	--	--	--	--	--	--	--	--	--	--	--	--	--	--	--	--	--	1	1	--	--	--	--	--	--	--	--	--	--
		Switch for Air Conditioning Unit 冷氣機開關掣	--	--	--	--	--	--	--	--	--	--	--	--	--	--	--	--	--	--	--	1	--	--	--	--	--	--	--	--	--	--	--
		TV/FM Outlet 電視/電台天線插座	--	--	--	--	--	--	--	--	--	--	--	--	--	--	--	--	--	--	--	1	--	--	--	--	--	--	--	--	--	--	--
		Telephone Outlet 電話插座	--	--	--	--	--	--	--	--	--	--	--	--	--	--	--	--	--	--	--	1	--	--	--	--	--	--	--	--	--	--	--
	RJ45 Outlet RJ45插座	--	--	--	--	--	--	--	--	--	--	--	--	--	--	--	--	--	--	--	1	--	--	--	--	--	--	--	--	--	--	--	
	Non-exposed Type 非外露型	13A Single Socket Outlet 13安培單位電插座	--	--	--	--	--	--	--	--	--	--	--	--	--	--	--	--	--	--	1	1	--	--	--	--	--	--	--	--	--	--	
		RJ45 Outlet RJ45插座	--	--	--	--	--	--	--	--	--	--	--	--	--	--	--	--	--	--	--	1	1	--	--	--	--	--	--	--	--	--	--
Utility Room (without lavatory) 工作間 (不附 設洗手間)	Exposed Type 外露型	Lighting Switch 燈掣	--	--	1	--	--	--	--	--	1	--	--	1	--	--	--	--	--	1	--	--	--	--	--	--	--	1	--	--	--	1	
		Lighting Point 燈位	--	--	1	--	--	--	--	--	1	--	--	1	--	--	--	--	--	1	--	--	--	--	--	--	--	1	--	--	--	1	
		13A Single Socket Outlet 13安培單位電插座	--	--	1	--	--	--	--	--	2	--	--	1	--	--	--	--	--	2	--	--	--	--	--	--	--	2	--	--	--	2	
		Switch for Air Conditioning Unit 冷氣機開關掣	--	--	--	--	--	--	--	--	--	--	--	--	--	--	--	--	--	--	--	--	--	--	--	--	--	1	--	--	--	1	
		Miniature Circuit Breakers Board 總電掣箱	--	--	--	--	--	--	--	--	1	--	--	--	--	--	--	--	--	1	--	--	--	--	--	--	--	1	--	--	--	1	

Notes:

- "1, 2," denotes the quantity of such provision(s) provided in the residential property.
- The symbol "--" as shown in the above table denotes "Not provided".
- 4/F, 13/F, 14/F, 24/F, 34/F & 44/F are omitted. 25/F is refuge floor.
- The vendor undertakes that if lifts or appliances of the specified brand name or model number are not installed in the Development, lifts or appliances of comparable quality will be installed.
- Non-exposed type socket outlet/power connection unit may be covered or hidden by false ceilings, bulk-heads, cabinets, claddings, non-concrete partition walls, designated pipe ducts or other materials.

備註:

- "1, 2," 表示提供於該住宅物業內的裝置數量。
- 上表「--」代表「不提供」。
- 不設4樓、13樓、14樓、24樓、34樓及44樓。25樓為隔火層。
- 賣方承諾如發展項目中沒有安裝指明的品牌名稱或產品型號的升降機或設備，便會安裝品質相若的升降機或設備。
- 非外露形電插座/電力接線座可能被假天花、假陣、貯存櫃、覆面、非混凝土間牆、指定之槽位或其他物料遮蓋。

SCHEDULE FOR LOCATION AND NUMBER OF MECHANICAL AND ELECTRICAL PROVISIONS OF RESIDENTIAL UNITS (TOWER 5) 住宅單位機電裝置位置及數量說明表 (第5座)

Location 位置	Description 描述	5/F 5樓										6/F-12/F, 15/F-23/F, 26/F-33/F, 35/F-43/F, 45/F-49/F 6樓-12樓, 15樓-23樓, 26樓-33樓, 35樓-43樓, 45樓-49樓										50/F & 51/F (Duplex Unit) 50樓及 51樓 (複式單位)		50/F 50樓						51/F 51樓			
		A	B	C	D	E	F	G	H	J	A	B	C	D	E	F	G	H	J	A	B	C	D	E	F	C	D	E	F				
Utility Room (with lavatory) 工作間 (附設 洗手間)	Exposed Type 外露型	Lighting Switch 燈掣	--	--	3	--	--	--	--	--	--	--	--	3	--	--	--	--	--	--	3	3	--	--	3	--	--	--	3	--			
		Lighting Point 燈位	--	--	1	--	--	--	--	--	--	--	--	1	--	--	--	--	--	--	1	1	--	--	1	--	--	--	1	--			
		13A Single Socket Outlet 13安培單位電插座	--	--	2	--	--	--	--	--	--	--	--	2	--	--	--	--	--	--	3	3	--	--	2	--	--	--	2	--			
		Telephone Outlet 電話插座	--	--	--	--	--	--	--	--	--	--	--	--	--	--	--	--	--	--	1	1	--	--	--	--	--	--	--	--			
		RJ45 Outlet RJ45插座	--	--	--	--	--	--	--	--	--	--	--	--	--	--	--	--	--	--	1	1	--	--	--	--	--	--	--	--			
		Switch for Air Conditioning Unit 冷氣機開關掣	--	--	1	--	--	--	--	--	--	--	--	1	--	--	--	--	--	--	1	1	--	--	1	--	--	--	1	--			
		Miniature Circuit Breakers Board 總電掣箱	--	--	1	--	--	--	--	--	--	--	--	1	--	--	--	--	--	--	1	1	--	--	1	--	--	--	1	--			
	Fibre Cable Point 光纖點位	--	--	--	--	--	--	--	--	--	--	--	--	--	--	--	--	--	--	1	1	--	--	--	--	--	--	--	--				
Non-exposed Type 非外露型	Fused Spur Unit 菲士接線座	--	--	1	--	--	--	--	--	--	--	1	--	--	--	--	--	--	--	--	--	--	--	--	--	--	--	--					
Lavatory inside Utility Room 工作間內之洗 手間	Exposed Type 外露型	Lighting Point 燈位	--	--	1	--	--	--	--	--	--	1	--	--	--	--	--	--	--	--	--	--	1	--	--	--	1	--					
	Non-exposed Type 非外露型	Fused Spur Unit 菲士接線座	--	--	--	--	--	--	--	--	--	--	--	--	--	--	--	--	--	--	--	--	1	--	--	--	1	--					
Lavatory 1 洗手間 1	Exposed Type 外露型	Lighting Point 燈位	--	--	--	--	--	--	--	--	--	--	--	--	--	--	--	--	3	1	--	--	--	--	--	--	--	--					
	Non-exposed Type 非外露型	Fused Spur Unit 菲士接線座	--	--	--	--	--	--	--	--	--	--	--	--	--	--	--	--	2	1	--	--	--	--	--	--	--	--					
Lavatory 2 洗手間 2	Exposed Type 外露型	Lighting Point 燈位	--	--	--	--	--	--	--	--	--	--	--	--	--	--	--	--	1	2	--	--	--	--	--	--	--	--					
	Non-exposed Type 非外露型	Fused Spur Unit 菲士接線座	--	--	--	--	--	--	--	--	--	--	--	--	--	--	--	--	1	2	--	--	--	--	--	--	--	--					

Notes:

- "1, 2," denotes the quantity of such provision(s) provided in the residential property.
- The symbol "--" as shown in the above table denotes "Not provided".
- 4/F, 13/F, 14/F, 24/F, 34/F & 44/F are omitted. 25/F is refuge floor.
- The vendor undertakes that if lifts or appliances of the specified brand name or model number are not installed in the Development, lifts or appliances of comparable quality will be installed.
- Non-exposed type socket outlet/power connection unit may be covered or hidden by false ceilings, bulk-heads, cabinets, claddings, non-concrete partition walls, designated pipe ducts or other materials.

備註:

- "1, 2," 表示提供於該住宅物業內的裝置數量。
- 上表「--」代表「不提供」。
- 不設4樓、13樓、14樓、24樓、34樓及44樓。25樓為隔火層。
- 賣方承諾如發展項目中沒有安裝指明的品牌名稱或產品型號的升降機或設備，便會安裝品質相若的升降機或設備。
- 非外露形電插座/電力接線座可能被假天花、假陣、貯存櫃、覆面、非混凝土間牆、指定之槽位或其他物料遮蓋。

SCHEDULE FOR LOCATION AND NUMBER OF MECHANICAL AND ELECTRICAL PROVISIONS OF RESIDENTIAL UNITS (TOWER 5) 住宅單位機電裝置位置及數量說明表 (第5座)

Location 位置	Description 描述	5/F 5樓										6/F-12/F, 15/F-23/F, 26/F-33/F, 35/F-43/F, 45/F-49/F 6樓-12樓, 15樓-23樓, 26樓-33樓, 35樓-43樓, 45樓-49樓										50/F & 51/F (Duplex Unit) 50樓及 51樓 (複式單位)		50/F 50樓						51/F 51樓			
		A	B	C	D	E	F	G	H	J	A	B	C	D	E	F	G	H	J	A	B	C	D	E	F	C	D	E	F				
Store Room 儲物室	Exposed Type 外露型	Lighting Switch 燈掣	--	--	--	1	--	--	--	--	--	--	--	--	1	--	--	--	--	--	2 ⁶	1	1	--	1	--	1	--	1	--	1	--	
		Lighting Point 燈位	--	--	--	1	--	--	--	--	--	--	--	--	1	--	--	--	--	--	2 ⁶	1	1	--	1	--	1	--	1	--	1	--	
		Miniature Circuit Breakers Board 總電掣箱	--	--	--	1	--	--	--	--	--	--	--	--	1	--	--	--	--	--	--	--	--	1	--	--	--	1	--	--	--	--	
		13A Single Socket Outlet 13安培單位電插座	--	--	--	--	--	--	--	--	--	--	--	--	--	--	--	--	--	--	1 ⁶	1	--	--	--	--	--	--	--	--	--	--	
Staircase 樓梯	Exposed Type 外露型	Lighting Switch 燈掣	--	--	--	--	--	--	--	--	--	--	--	--	--	--	--	--	--	7	6	--	--	--	--	--	--	--	--	--	--		
		Lighting Point 燈位	--	--	--	--	--	--	--	--	--	--	--	--	--	--	--	--	--	7	4	--	--	--	--	--	--	--	--	--	--		
		13A Single Socket Outlet 13安培單位電插座	--	--	--	--	--	--	--	--	--	--	--	--	--	--	--	--	--	2	2	--	--	--	--	--	--	--	--	--	--		
Balcony 露台	Exposed Type 外露型	Balcony Light 露台燈	--	--	--	--	--	--	--	--	1	--	1	1	1	1	1	1	1	--	1	1	1	1	1	1	1	1	1	1	1		
		Fused Spur Unit 菲士接線座	--	--	--	--	--	--	--	--	--	--	--	--	1	1	1	1	--	--	--	--	1	1	--	--	1	1	--	--	--		
Utility Platform 工作平台	Exposed Type 外露型	Utility Platform Light 工作平台燈	--	--	1	1	--	--	--	--	1	1	1	1	1	1	1	1	1	--	--	1	1	1	1	1	1	1	1	1			
	Non-exposed Type 非外露型	Fused Spur Unit 菲士接線座	--	--	--	--	--	--	--	--	--	1	--	--	--	--	--	--	--	--	--	--	--	--	--	--	--	--	--	--			

Notes:

- "1, 2," denotes the quantity of such provision(s) provided in the residential property.
- The symbol "--" as shown in the above table denotes "Not provided".
- 4/F, 13/F, 14/F, 24/F, 34/F & 44/F are omitted. 25/F is refuge floor.
- The vendor undertakes that if lifts or appliances of the specified brand name or model number are not installed in the Development, lifts or appliances of comparable quality will be installed.
- Non-exposed type socket outlet/power connection unit may be covered or hidden by false ceilings, bulk-heads, cabinets, claddings, non-concrete partition walls, designated pipe ducts or other materials.
- There are 2 numbers of store rooms in Unit A (Duplex Unit) on 50/F & 51/F. The number of mechanical and electrical provisions marked on this table are the total sum of mechanical and electrical provisions in these 2 store rooms.

備註:

- "1, 2," 表示提供於該住宅物業內的裝置數量。
- 上表「--」代表「不提供」。
- 不設4樓、13樓、14樓、24樓、34樓及44樓。25樓為隔火層。
- 賣方承諾如發展項目中沒有安裝指明的品牌名稱或產品型號的升降機或設備，便會安裝品質相若的升降機或設備。
- 非外露型電插座/電力接線座可能被假天花、假陣、貯存櫃、覆面、非混凝土間牆、指定之槽位或其他物料遮蓋。
- 50樓及51樓A單位（複式單位）設有2間儲物室，此處機電裝置的數量為2間儲物室的總和。

SCHEDULE FOR LOCATION AND NUMBER OF MECHANICAL AND ELECTRICAL PROVISIONS OF RESIDENTIAL UNITS (TOWER 5) 住宅單位機電裝置位置及數量說明表 (第5座)

Location 位置	Description 描述	5/F 5樓										6/F-12/F, 15/F-23/F, 26/F-33/F, 35/F-43/F, 45/F-49/F 6樓-12樓, 15樓-23樓, 26樓-33樓, 35樓-43樓, 45樓-49樓										50/F & 51/F (Duplex Unit) 50樓及 51樓 (複式單位)		50/F 50樓						51/F 51樓			
		A	B	C	D	E	F	G	H	J	A	B	C	D	E	F	G	H	J	A	B	C	D	E	F	C	D	E	F				
Flat Roof 平台	Exposed Type 外露型	Lighting Point 燈位	14	6	11	4	7	8	8	6	11	--	--	--	--	--	--	--	--	--	3	--	--	--	--	--	--	--	--	--	--	--	
		13A Weatherproof Single Socket Outlet 13安培防水單位電插座	3	1	3	1	2	2	2	1	2	--	--	--	--	--	--	--	--	--	1	1	--	--	--	--	--	--	--	--	--	--	
	Non-exposed Type 非外露型	Fused Spur Unit 菲士接線座	--	1	--	1	1	1	1	--	--	--	--	--	--	--	--	--	--	--	--	--	--	--	--	--	--	--	--	--	--	--	
Private Roof 私人天台	Exposed Type 外露型	Weatherproof Lighting Switch 防水燈掣	--	--	--	--	--	--	--	--	--	--	--	--	--	--	--	--	--	--	--	--	--	--	--	--	--	--	1	1	1	1	
		Lighting Point 燈位	--	--	--	--	--	--	--	--	--	--	--	--	--	--	--	--	--	--	8	6	--	--	--	--	--	--	7	3	10	8	
		13A Weatherproof Single Socket Outlet 13安培防水單位電插座	--	--	--	--	--	--	--	--	--	--	--	--	--	--	--	--	--	--	3	3	--	--	--	--	--	--	2	1	2	2	
	Non-exposed Type 非外露型	Fused Spur Unit 菲士接線座	--	--	--	--	--	--	--	--	--	--	--	--	--	--	--	--	--	--	1	2	--	--	--	--	--	--	--	--	--	--	
		13A Weatherproof Single Socket Outlet 13安培防水單位電插座	--	--	--	--	--	--	--	--	--	--	--	--	--	--	--	--	--	--	1	1	--	--	--	--	--	--	1	1	1	1	
		RJ45 Outlet RJ45插座	--	--	--	--	--	--	--	--	--	--	--	--	--	--	--	--	--	--	1	1	--	--	--	--	--	--	1	1	1	1	
		Jacuzzi Weatherproof Isolator 按摩浴缸防水開關掣	--	--	--	--	--	--	--	--	--	--	--	--	--	--	--	--	--	--	1	1	--	--	--	--	--	--	--	--	--	--	
Air- Conditioner Platform 空調機平台	Exposed Type 外露型	A/C Unit Weatherproof Isolator 空調機防水開關掣	3	2	3	2	1	1	1	2	2	3	2	3	2	1	1	1	2	2	7	6	2	1	4	3	2	1	4	2			

Notes:

- "1, 2," denotes the quantity of such provision(s) provided in the residential property.
- The symbol "--" as shown in the above table denotes "Not provided".
- 4/F, 13/F, 14/F, 24/F, 34/F & 44/F are omitted. 25/F is refuge floor.
- The vendor undertakes that if lifts or appliances of the specified brand name or model number are not installed in the Development, lifts or appliances of comparable quality will be installed.
- Non-exposed type socket outlet/power connection unit may be covered or hidden by false ceilings, bulk-heads, cabinets, claddings, non-concrete partition walls, designated pipe ducts or other materials.

備註:

- "1, 2," 表示提供於該住宅物業內的裝置數量。
- 上表「--」代表「不提供」。
- 不設4樓、13樓、14樓、24樓、34樓及44樓。25樓為隔火層。
- 賣方承諾如發展項目中沒有安裝指明的品牌名稱或產品型號的升降機或設備，便會安裝品質相若的升降機或設備。
- 非外露型電插座/電力接線座可能被假天花、假陣、貯存櫃、覆面、非混凝土間牆、指定之槽位或其他物料遮蓋。

Potable and flushing water is supplied by Water Supplies Department.

Electricity is supplied by CLP Power Hong Kong Limited.

Towngas is supplied by The Hong Kong and China Gas Company Limited.

食水及沖廁水由水務署供應。

電力由中華電力有限公司供應。

煤氣由香港中華煤氣有限公司供應。

The Vendor (the owner) is liable for the Government Rent payable for the specified residential property up to and including the date of the assignment of that specified property.

賣方（擁有人）有法律責任繳付該指明住宅物業之地稅直至該指明住宅物業的轉讓契日期（包括該日）為止。

1. On the delivery of the vacant possession of the specified residential property to the purchaser, the purchaser is liable to reimburse the Vendor (the owner) for the deposits for water, electricity and gas; and
2. On the delivery, the purchaser is not liable to pay to the Vendor (the owner) a debris removal fee.

Note: On that delivery, the purchaser is liable to pay a debris removal fee to the manager (not the owner) of the Development under the deed of the mutual covenant, and where the owner has paid that debris removal fee, the purchaser shall reimburse the owner for the same.

1. 在向買方交付指明住宅物業在空置情況下的管有權時，買方須負責向賣方（擁有人）補還水、電力及氣體的按金；及
2. 在交付時，買方不須向賣方（擁有人）支付清理廢料的費用。

備註：在交付時，買方須根據公契向發展項目的管理人（而非擁有人）支付清理廢料的費用，而如擁有人已支付清理廢料的費用，買方須向擁有人補還清理廢料的費用。

As provided in the agreement for sale and purchase, the Vendor shall, at its own cost and as soon as reasonably practicable after receipt of a written notice served by the purchaser within 6 months after the date of completion of the sale and purchase of the specified residential property, remedy any defects in that residential property, or the fittings, finishes or appliances incorporated into that residential property as set out in the agreement for sale and purchase concerned, caused otherwise than by the act or neglect of the purchaser.

按買賣合約的規定，凡指明住宅物業或於買賣合約列出裝設於該住宅物業內的裝置、裝修物料或設備有欠妥之處，而該欠妥之處並非由買方行為或疏忽造成，則賣方在接獲買方在該住宅物業之買賣成交日期後的6個月內送達的書面通知後，須於合理地切實可行的範圍內盡快自費作出補救。

A. The land grant requires the owners of the residential properties in the Development to maintain any slope at their own cost

1. The terms of requirement :-

Special Condition No.(57) of the Land Grant stipulates that:

- (a) Where there is or has been any cutting away, removal or setting back of any land, or any building-up or filling-in or any slope treatment works of any kind whatsoever, whether with or without the prior written consent of the Director, either within the lot or on any Government land, which is or was done for the purpose of or in connection with the formation, levelling or development of the lot or any part thereof or any other works required to be done by the Grantee under these Conditions, or for any other purpose, the Grantee shall at his own expense carry out and construct such slope treatment works, retaining walls or other support, protection, drainage or ancillary or other works as shall or may then or at any time thereafter be necessary to protect and support such land within the lot and also any adjacent or adjoining Government or leased land and to obviate and prevent any falling away, landslip or subsidence occurring thereafter. The Grantee shall at all times during the term hereby agreed to be granted maintain at his own expense the said land, slope treatment works, retaining walls or other support, protection, drainage or ancillary or other works in good and substantial repair and condition to the satisfaction of the Director.
- (b) Nothing in sub-clause (a) of this Special Condition shall prejudice the Government's rights under these Conditions, in particular Special Condition No.(56) hereof.
- (c) In the event that as a result of or arising out of any formation, levelling, development or other works done by the Grantee or owing to any other reason, any falling away, landslip or subsidence occurs at any time, whether in or from any land within the lot or from any adjacent or adjoining Government or leased land, the Grantee shall at his own expense reinstate and make good the same to the satisfaction of the Director and shall indemnify the Government, its agents and contractors from and against all costs, charges, damages, demands and claims whatsoever which shall or may be made, suffered or incurred through or by reason of such falling away, landslip or subsidence.
- (d) In addition to any other rights or remedies herein provided for breach of any of these Conditions, the Director shall be entitled by notice in writing to call upon the Grantee to carry out, construct and maintain the said land, slope treatment works, retaining walls, or other support, protection, and drainage or ancillary or other works or to reinstate and make good any falling away, landslip or subsidence, and if the Grantee shall neglect or fail to comply with the notice to the satisfaction of the Director within the period specified therein, the Director may forthwith execute and carry out any necessary works and the Grantee shall on demand repay to the Government the cost thereof, together with any administrative and professional fees and charges.

2. Each of the owners of the Development is obliged to contribute towards the costs of the maintenance work.

3. The plan showing the slope, retaining wall or related structures constructed, or to be constructed, within or outside the land on which the Development is situated.

Not applicable.

B. Owner's undertaking to maintain any slope in relation to the Development at that owner's own cost

Not applicable.

C. Under the Deed of Mutual Covenant, the manager of the Development has the owners' authority to carry out the maintenance work

Under the Deed of Mutual Covenant, the Manager of the Development has the owners' authority to engage suitable qualified personnel to inspect keep and maintain any of the Slopes and Retaining Walls (if any) in compliance with the Government Grant and in accordance with the "Geoguide 5 – Guide to Slope Maintenance" issued by the Geotechnical Engineering Office (as amended or substituted from time to time) and the Slope Maintenance Manual and all guidelines issued from time to time by the appropriate government department regarding the maintenance of slopes, retaining walls and related structures and to collect from the Owners (save and except F.S.I. as Owner of the Government Accommodation) all costs lawfully incurred or to be incurred by the Manager in carrying out such maintenance, repair and other works.

A. 批地文件規定，發展項目中的住宅物業的擁有人須自費維修任何斜坡

1. 有關規定的條款 :-

批地文件特別批地條款第(57)條規定：

- (a) 倘為了或有關該地段或其任何部份之形成、平整或發展或根據此等條款承批人須完成之任何其他工程或因任何其他目的，於該地段內或任何政府土地上現時或以往曾經進行任何削走、移除或移後任何土地、或任何建造或填土或任何斜坡處理工程，不論以何種形式、亦不論有否獲得署長事先書面同意，承批人須自費進行及建造為保護及支承該地段內之土地及任何毗連或毗鄰政府土地或已租出土地及排除及防止其後發生之任何崩塌、山崩或下陷而當時或日後任何時間所須之斜坡處理工程，護土牆或其他支承、保護、排水或附屬或其他工程。承批人須於批地年期內所有時間自費保養該土地、斜坡處理工程、護土牆或其他支承、保護、排水或附屬或其他工程，以令其保持修葺良好堅固和狀況良好以令署長滿意。
- (b) 本特別批地條款第(a)條的任何規定不得影響政府在此等條款下的權利，尤其是本文特別批地條款第(56)條。
- (c) 倘因或由於承批人作出之形成、平整、發展或其他工程或因其他原因於任何時間不論在或由任何在該地段內土地或任何毗連或毗鄰政府土地或已租出土地導致或產生崩塌、山崩或下陷，承批人須自費使其回復原狀及將其修復令署長滿意，並須彌償政府、其代理及承建商因該崩塌、山崩或下陷而導致、蒙受或招致之所有任何性質的費用、收費、損害、訴求及索償。
- (d) 除了規定就任何違反此等條款的任何其他權利或補救之外，署長有權以書面通知要求承批人進行、建造及保養該等土地、斜坡處理工程、護土牆、或其他支承、保護、及排水或附屬或其他工程，或使其回復原狀及修復任何崩塌、山崩或下陷。倘承批人在該通知指定期限內忽視或未能遵守該通知以令署長滿意，署長可立即執行及進行任何必須之工程而承批人須應要求向政府付還有關費用連同任何行政或專業費用及收費。

2. 發展項目中的每名擁有人均須分擔維修工程的費用。

3. 顯示該斜坡及已經或將會在發展項目所位的土地之內或之外建造的任何護土牆或有關結構物的圖則。

不適用。

B. 擁有人自費就發展項目維修任何斜坡的承諾

不適用。

C. 根據公契，發展項目的管理人獲擁有人授權進行維修工程

根據公契，管理人獲發展項目擁有人授權聘請適當合資格人員以遵守批地文件並按照土力工程處發出的「岩土指南第五冊—斜坡維修指南」（以其不時修訂或取代為準）及《斜坡維修手冊》，以及按照由恰當政府部門不時發出有關斜坡、護土牆及相關構築物的所有指南，檢查、保存及保養任何斜坡及護土牆（如有），並向所有擁有人（財政司法團作為政府樓宇的擁有人除外）收取因管理人進行這等保養、維修及任何其他工程而合法地已招致或將會招致的一切費用。

Not applicable.

不適用。

1. Noise Mitigation Measures

The following measures to mitigate road traffic noise impact from Fo Tan Road and railway noise impact are provided in the Development. For detail locations of the measures, please refer to "Floor Plans of Residential Properties in the Development":

- a) Fixed Glazing (with or without Maintenance Window) - the fixed glazing and maintenance window would be with glass pane, which are provided at selected residential units. Therefore, noise would be reduced from entering into the rooms such that an acceptable indoor environment can be achieved. The maintenance windows need not be opened for ventilation and would only be opened occasionally for cleansing or maintenance. The maintenance window is only openable with a special key where necessary.
- b) Baffle Type Acoustic Window - has an inner sliding glass panel behind an outer window, both readily openable, for creating an air gap for the supply of fresh air with noise mitigating effect, which are located in selected residential units. It comprises two glazing - (i) the outer window system with side hung openable window and (ii) the inner sliding panel.
- c) Baffle Type Acoustic Door - has an inner sliding glass panel behind an outer door, both readily openable, for creating an air gap for the supply of fresh air with noise mitigating effect, which are located in selected residential units. It comprises two glazing - (i) the outer door system with openable door and (ii) the inner sliding panel.
- d) Baffle Type Acoustic Door of Utility Platform (with Sound Absorption Material at Ceiling) - has an inner sliding glass panel behind an outer door, both readily openable, for creating an air gap for the supply of fresh air with noise mitigation effect, which are located in selected residential units. It comprises two glazing - (i) the outer door system with openable door and (ii) the inner sliding panel and the ceiling on top of the Utility platform will be applied with sound absorption material to minimize the potential noise reflection from the ceiling.
- e) Acoustic Balcony - Balcony with solid parapet are located in selected residential units. The ceiling and soffit on top of the balcony will be applied with sound absorptive material to minimize the potential noise reflection from the ceiling. Moreover, the noise would be shielded by the solid parapet of the balcony when the roads are located below.
- f) Solid Wall erected at Transfer Plate (minimum level at 31.27 metres above the Hong Kong Principal Datum (for Tower 1 and Tower 2) and 31.55 metres above the Hong Kong Principal Datum (for Tower 3)) -located in selected residential units. The noise would be shielded by the solid wall erected on the transfer plates, when the road and railway are located below.
- g) Baffle Type Acoustic Door with Solid Parapet Balcony (with Sound Absorption Material at Ceiling) - has an inner sliding glass panel behind an outer door, both readily openable, for creating an air gap for the supply of fresh air with noise mitigation effect, which are located in selected residential units. It comprises two glazing - (i) the outer door system with openable door and (ii) the inner sliding panel. And the ceiling on top of the balcony will be applied with sound absorption material to minimize the potential noise reflection from the ceiling.
- h) Vertical Acoustic Fin at Balcony or Utility Platform with Sound Absorption Material.
- i) Self-closing Door
- j) Solid Wall erected at Flat Roof (minimum level at 154.77 metres above the Hong Kong Principal Datum (for Tower 1 and Tower 2) -located in selected residential units. The noise would be shielded by the solid wall erected on the flat roof when the railways are located below.

1. 紓緩噪音之措施

發展項目提供以下措施，以緩解火炭路的道路交通噪音影響及鐵路噪音影響，有關措施的位置，請參考「發展項目的住宅物業的樓面平面圖」：

- a) 固定玻璃窗戶（配有或不配有維修用窗） — 配有玻璃的固定玻璃窗戶和維修用窗會在個別住宅單位提供。此窗戶可將傳播至室內的噪音減弱從而達到可接受的室內環境。維修用窗不能作通風之用及只能在作清潔或維修時開啓。維修用窗只能在必要時利用配備鎖匙開啓。
- b) 擋音式減音窗戶 — 個別住宅單位的外層窗戶背面附有可滑動的內層嵌板，兩者都是可開啟的，當中的氣隙能用作供應新鮮空氣及可減弱室外噪音。擋音式減音窗戶由雙層玻璃組成 - (i) 配有可開啟的側吊窗的外層窗戶系統和(ii) 可滑動的內層嵌板。
- c) 擋音式減音門 — 個別住宅單位的外層落地玻璃門背面附有可滑動的內層嵌板，兩者都是可開啟的，當中的氣隙能用作供應新鮮空氣及可減弱室外噪音。擋音式減音門由雙層玻璃組成 - (i) 配有可開啟的玻璃門的外層落地玻璃門系統和(ii) 可滑動的內層嵌板。
- d) 配有減音天花的工作平台的擋音式減音門 — 個別住宅單位的外層玻璃門背面附有可滑動的內層嵌板，兩者都是可開啟的，當中的氣隙能用作供應新鮮空氣及可減弱室外噪音。配有減音天花的工作平台的擋音式減音門由雙層玻璃組成 - (i) 配有可開啟的玻璃門的外層落地玻璃門系統和 (ii) 可滑動的內層嵌板及工作平台天花配有吸音物料將潛在由天花反射的噪音減少到最低限度。
- e) 減音露台 — 個別住宅單位的露台配有密封圍欄。露台天花配有吸音物料將潛在由天花反射的噪音減少到最低限度。此外，露台的密封圍欄能阻隔從下方馬路所產生的噪音。
- f) 位於轉換層的實心牆（最低水平為香港主水平基準以上31.27米（第1及第2座）及香港主水平基準以上31.55米（第3座）） — 個別住宅單位配有置於轉換層的密封圍欄。轉換層的實心牆能阻隔從下方馬路及鐵路所產生的噪音。
- g) 配有密封圍欄及減音天花的露台的擋音式減音門 — 個別住宅單位的外層玻璃門背面附有可滑動的內層嵌板，兩者都是可開啟的，當中的氣隙能用作供應新鮮空氣及可減弱室外噪音。配有減音天花的露台的擋音式減音門由雙層玻璃組成 - (i) 配有可開啟的玻璃門的外層落地玻璃門系統和 (ii) 可滑動的內層嵌板。露台天花配有吸音物料將潛在由天花反射的噪音減少到最低限度。
- h) 配有吸音物料的垂直隔音簷置於露台或工作平台
- i) 自行關閉式門
- j) 位於平台的實心牆（最低水平為香港主水平基準以上154.77米（第1及第2座）） — 個別住宅單位配有置於平台的實心牆。平台的實心牆能阻隔從下方鐵路所產生的噪音。

2. Placement of outdoor air-conditioning units

Some outdoor air-conditioning units (either serving its own residential unit or other residential units) are placed on the air-conditioner platforms adjacent to/adjoining some residential units, private/common flat roofs, private roofs or flat roofs of some residential units. The placement of the outdoor air-conditioning units may affect the enjoyment of the residential units of the Development in terms of heat and noise or other aspects. For the locations of the outdoor air-conditioner platform, please refer to “Floor Plans of Residential Properties” in the Development.

3. Architectural features

Some architectural features are installed outside the external walls of some residential units of the Development. The illumination (if any) of the architectural features may affect the enjoyment of some residential units.

4. Operation of building maintenance system

Under the Deed of Mutual Covenant, the Manager shall have the right from time to time for the purposes of inspecting, examining, rebuilding, repairing, renewing, maintaining, cleansing, painting or decorating the Common Areas and Facilities or carrying out necessary repairs to the Development or to install and remove anchors and other provisions at the building perimeter of the private flat roof or private roof forming part of a residential unit for operation of the building maintenance system including but not limited to gondola or an equipment of the like which shall be entitled to pass through and/or rest on private flat roof or private roof forming part of a residential unit.

5. “Access and Working Place for Drainage Pipe” and “Concrete Enclosure for Common Drainage Pipe”

In relation to the flat roofs of 5th Floor of Towers 1, 2, 3 & 5 of the Development, there are certain Residential Common Areas marked “Access and Working Place for Drainage Pipe” and “Concrete Enclosure for Common Drainage Pipe” which have to be accessed through certain Residential Units on the 5th Floor of the said Towers.

6. Update of Plans

In relation to the following residential units, the Authorized Person of the Development has obtained approval of the Building Authority to alter the building plans and the relevant DMC plans affected by such alterations have been submitted to the Legal Advisory and Conveyancing Office of the Lands Department for update or approval (as the case may be).

Tower	Floor	Unit
Tower 1	5/F	E, F & H
	49/F	A, B & C
Tower 2	5/F	A, C, D, F & H
	48/F	E
	49/F	A & B
Tower 3	5/F	B, C, D, E, G, H & J
	50/F	C & E
	51/F	C, E & F
	50/F & 51/F	A & B (Duplex Unit)
Tower 5	5/F	B, D, F, G & J
	50/F	E
	51/F	C, D, E & F
	50/F & 51/F	A & B (Duplex Unit)

2. 放置室外空調機

部分室外空調機（不論是為該住宅單位而設或是為其他住宅單位而設）放置在毗鄰/毗連部份住宅單位的空調機平台、私人/公共平台、私人天台或平台。室外空調機的放置可能對發展項目的住宅單位的享用，如熱氣及噪音或其他方面造成影響。有關室外空調機平台的位置，請參閱發展項目的住宅物業的樓面平面圖。

3. 建築裝飾

發展項目部分住宅單位外的外牆裝有建築裝飾，建築裝飾的燈光（如有的話）可能對部分住宅單位的享用造成影響。

4. 建築物維修系統的操作

根據公契，管理人有權不時為檢查、考查、重建、維修、翻新、保養、清潔、油漆或裝飾公用地方及設施或發展項目或於構成住宅單位一部分的私人平台或私人天台的建築周邊安裝及拆除錨及其他裝置以便建築物維修系統的操作，包括但不限於吊船或其他類似裝置。吊船或其他類似裝置可以經過及/或停泊於構成住宅單位一部分的私人平台或私人天台。

5. 「排水管道維修空間」及「公共排水管道的混凝土圍封」

有關發展項目第一座，二座，三座及第五座五樓平台存在某些住宅公用地方並以「排水管道維修空間」及「公共排水管道的混凝土圍封」標記，並且需經由某些於相關座的五樓住宅單位而進入。

6. 更新圖則

有關以下住宅單位，發展項目的認可人士已取得建築事務監督更改建築圖則的批准，而就該更改而受影響的公契圖則已遞交予地政總署的法律諮詢及填田轉易處以待更新或審批（視乎情況而定）。

座數	樓層	單位
第1座	5樓	E、F及H
	49樓	A、B及C
第2座	5樓	A、C、D、F及H
	48樓	E
	49樓	A及B
第3座	5樓	B、C、D、E、G、H及J
	50樓	C及E
	51樓	C、E及F
	50樓及51樓	A及B（複式單位）
第5座	5樓	B、D、F、G及J
	50樓	E
	51樓	C、D、E及F
	50樓及51樓	A及B（複式單位）

Remarks:

Noise mitigation measures include Fixed Glazing (with or without Maintenance Window), Baffle Type Acoustic Window, Baffle Type Acoustic Door, Baffle Type Acoustic Door of Utility Platform (with Sound Absorption Material at Ceiling), Acoustic Balcony, Solid Wall erected at Transfer Plate (minimum level at 31.27 metres above the Hong Kong Principal Datum (for Tower 1 and Tower 2) and 31.55 metres above the Hong Kong Principal Datum (for Tower 3), Baffle Type Acoustic Door with Solid Parapet Balcony (with Sound Absorption Material at Ceiling), Vertical Acoustic Fin, Self-closing Door and Solid Wall erected at Flat Roof (minimum level at 154.77 metres above the Hong Kong Principal Datum (for Tower 1 and Tower 2)) applied to selected residential units. No owner of residential units shall make or permit or suffer to be made any alteration or conversion or modification of Fixed Glazing (with or without Maintenance Window), Baffle Type Acoustic Window, Baffle Type Acoustic Door, Baffle Type Acoustic Door of Utility Platform (with Sound Absorption Material at Ceiling), Acoustic Balcony, Solid Wall erected at Transfer Plate (minimum level at 31.27 metres above the Hong Kong Principal Datum (for Tower 1 and Tower 2) and 31.55 metres above the Hong Kong Principal Datum (for Tower 3), Baffle Type Acoustic Door with Solid Parapet Balcony (with Sound Absorption Material at Ceiling), Vertical Acoustic Fin, Self-closing Door and Solid Parapet erected at Flat Roof (minimum level at 154.77 metres above the Hong Kong Principal Datum (for Tower 1 and Tower 2) without the prior written consent of the Building Authority and other relevant government authorities. The height or top level of Solid Parapet indicated in the above description is the minimum level to be provided as noise mitigation measure. In addition to the fixed glazing of noise mitigation measures, other non-noise mitigation measures fixed glazing may be installed at residential units.

備註：

紓緩噪音之措施包括適用於個別住宅單位設置的固定玻璃窗戶（配有或不配有維修用窗）、擋音式減音窗戶、擋音式減音門、配有減音天花的工作平台的擋音式減音門、減音露台、位於轉換層的實心牆（最低水平為香港主水平基準以上31.27米（第1及第2座）及香港主水平基準以上31.55米（第3座））、配有密封圍欄及減音天花的露台的擋音式減音門、垂直隔音簷、自行關閉式門及位於平台的實心牆（最低水平為香港主水平基準以上154.77米（第1及第2座））。除非獲得建築事務監督及/或其他政府有關當局的事先書面同意，住宅單位的業主不可作出或允許或忍受他人作出對固定玻璃窗戶（配有或不配有維修用窗）、擋音式減音窗戶、擋音式減音門、配有減音天花的工作平台的擋音式減音門、減音露台、位於轉換層的實心牆（最低水平為香港主水平基準以上31.27米（第1及第2座）及香港主水平基準以上31.55米（第3座））、配有密封圍欄及減音天花的露台的擋音式減音門、垂直隔音簷、自行關閉式門及位於平台的實心牆（最低水平為香港主水平基準以上154.77米（第1及第2座））的任何改動或變更。在以上描述的實心牆的高度或水平是作為紓緩噪音之措施的最低水平。除紓緩噪音之措施的固定玻璃窗戶，住宅單位或有裝配非紓緩噪音之措施的固定玻璃窗戶。

The address of the website designated by the Vendor of the Development for the purposes of Part 2 of the Residential Properties (First-hand Sales) Ordinance:
www.thearles.com.hk

賣方為施行《一手住宅物業銷售條例》第2部而就發展項目指定的互聯網網站的網址：
www.thearles.com.hk

Breakdown of GFA Concessions Obtained for All Features

Latest information on breakdown of GFA concessions as shown on the general building plans submitted to and approved by the Building Authority (BA) prior to the printing of the sales brochure is tabulated below. Information marked (#) may be based on information provided by the authorized person if the sales brochure is printed prior to submission of the final amendment plans to the BA. The breakdown of GFA concessions may be subject to further changes until final amendment plans are submitted to and approved by the BA prior to the issuance of the occupation permit for the Development.

獲寬免總樓面面積的設施分項

於印製售樓說明書前呈交予並已獲建築事務監督批准的一般建築圖則上有關總樓面面積寬免的分項的最新資料，請見下表。如印製售樓說明書時尚未呈交最終修訂圖則予建築事務監督，則有(#)號的資料可以由認可人士提供的資料作為基礎。直至最終修訂圖則於發出佔用許可證前呈交予並獲建築事務監督批准前，以下分項資料仍可能有所修改。

Disregarded GFA under Building (Planning) Regulations 23(3)(b) 根據《建築物(規劃)條例》第23(3)(b)條不計算的總樓面面積		Area (m ²) 面積(平方米)
1 [#]	Carpark and loading / unloading area excluding public transport terminus 停車場及上落客貨地方	NIL 沒有
2	Plant rooms and similar services 機房及相類設施	
2.1	Mandatory feature or essential plant room, area of which is limited by respective Practice Notes for Authorized Persons, Registered Structural Engineers and Registered Geotechnical Engineers (PNAP) or regulation such as lift machine room, telecommunications and broadcasting (TBE) room, refuse storage and material recovery chamber, etc. 所佔面積受相關《認可人士、註冊結構工程師及註冊岩土工程師作業備考》或規例限制的強制性設施或必要機房，例如升降機機房、電訊及廣播設備室、垃圾及物料回收房等	NIL 沒有
2.2 [#]	Mandatory feature or essential plant room, area of which is NOT limited by any PNAP or regulation such as room occupied solely by fire services installations (FSI) and equipment, meter room, transformer room, potable and flushing water tank, etc. 所佔面積不受任何《認可人士、註冊結構工程師及註冊岩土工程師作業備考》或規例限制的強制性設施或必要機房，例如僅供消防裝置及設備佔用的房間、電錶房、電力變壓房、食水及鹹水缸等	NIL 沒有
2.3	Non-mandatory or non-essential plant room such as air-conditioning plant room, air handling unit (AHU) room, etc. 非強制性或非必要機房，例如空調機房、風櫃房等	263.648 (Non-Domestic) (非住用)

Green Features under Joint Practice Notes 1 and 2 根據聯合作業備考第1及第2號提供的環保設施		
3	Balcony 露台	1347.483 (Domestic) (住用)
4	Wider common corridor and lift lobby 加闊的公用走廊及升降機大堂	Not applicable 不適用
5	Communal sky garden 公用空中花園	Not applicable 不適用
6	Acoustic fin 隔聲簷	93.888 (Domestic) (住用)
7	Wing wall, wind catcher and funnel 翼牆、捕風器及風斗	Not applicable 不適用
8	Non-structural prefabricated external wall 非結構預製外牆	622.879 (Domestic) (住用)
9	Utility platform 工作平台	835.500 (Domestic) (住用)
10	Noise barrier 隔音屏障	Not applicable 不適用

Note:

The above table is based on the requirements as stipulated in the Practice Note for Authorized Persons, Registered Structural Engineers and Registered Geotechnical Engineers ADM-2 issued by the Buildings Department. The Buildings Department may revise such requirements from time to time as appropriate.

備註：

上述表格是根據屋宇署所發出的《認可人士、註冊結構工程師及註冊岩土工程師作業備考》ADM-2規定的要求而制訂的。屋宇署會按實際需要不時更改有關要求。

Amenity features 適意設施		
11	Counter, office, store, guard room and lavatory for watchman and management staff, Owners' Corporatoin Office 供保安人員和管理處員工使用的櫃枱、辦公室、儲物室、警衛室和廁所、業主立案法團辦公室	83.535 (Domestic) (住用)
12	Residential Recreational facilites including void, plant room, swimming pool filtration plant room, covered walkway etc. serving solely the recreational facilities 住宅康樂設施，包括僅供康樂設施使用的中空、機房、游泳池的濾水器機房、有蓋行人道等	2838.647 (Domestic) (住用)
13	Covered landscaped and play area 有上蓋的園景區及遊樂場	1735.360 (Domestic) (住用)
14	Horizontal screens/covered walkways, trellis 橫向屏障 / 有蓋人行道、花棚	303.958 (Domestic) (住用)
15	Larger lift shaft 擴大升降機井道	1567.956 (Domestic) (住用)
16	Chimney shaft 煙囪管道	Not applicable 不適用
17	Other non-mandatory or non-essential plant room, such as boiler room, satellite master antenna television (SMATV) room 其他非強制性或非必要機房，例如鍋爐房、衛星電視共用天線房	25.319 (Domestic) (住用)
18 [#]	Pipe duct, air duct for mandatory feature or essential plant room 強制性設施或必要機房所需的管槽、氣槽	Not applicable 不適用
19	Pipe duct, air duct for non-mandatory or non-essential plant room 非強制性設施或非必要機房所需的管槽、氣槽	Not applicable 不適用
20	Plant room pipe duct, air duct for environmentally friendly system and feature 環保系統及設施所需的機房、管槽及氣槽	182.433 (Domestic) (住用)
21	Void in duplex domestic flat and house 複式住宅單位及洋房的中空	Not applicable 不適用
22	Projections such as air-conditioning box and platform with a projection of more than 750mm from the external wall 伸出物，如空調機箱及伸出外牆超過 750 毫米的平台	Not applicable 不適用

Other Exempted Items 其他項目		
23 [#]	Refuge floor including refuge floor cum sky garden 庇護層，包括庇護層兼空中花園	1967.404 (Domestic) (住用)
24 [#]	Other projections 其他伸出物	Not applicable 不適用
25	Public transport terminus 公共交通總站	5,043.526
26 [#]	Party structure and common staircase 共用建築物及樓梯	Not applicable 不適用
27 [#]	Horizontal area of staircase, lift shaft and vertical duct solely serving floor accepted as not being accountable for GFA 僅供獲接納不計入總樓面面積的樓層使用的樓梯、升降機槽及垂直管道的水平面積公眾通道	Not applicable 不適用
28 [#]	Public passage 公眾通道	Not applicable 不適用
29	Covered set back area 因建築物後移導致的覆蓋面積	Not applicable 不適用
Bouns GFA 額外總樓面面積		
30	Bonus GFA 額外總樓面面積	Not applicable 不適用

Note:

The above table is based on the requirements as stipulated in the Practice Note for Authorized Persons, Registered Structural Engineers and Registered Geotechnical Engineers ADM-2 issued by the Buildings Department. The Buildings Department may revise such requirements from time to time as appropriate.

備註：

上述表格是根據屋宇署所發出的《認可人士、註冊結構工程師及註冊岩土工程師作業備考》ADM-2規定的要求而制訂的。屋宇署會按實際需要不時更改有關要求。

Environmental Assessment of the Building

建築物的環境評估

Green Building Certification

Assessment result under the **BEAM Plus** certification conferred / issued by Hong Kong Green Building Council Limited (HKGBC) for the building prior to the printing of the sales brochure or its addenda.

**Provisional
UNCLASSIFIED**



Application no.: PAU0058/20

綠色建築認證

在印刷此售樓說明書或其附頁前，本物業根據香港綠色建築議會有限公司頒授 / 發出的綠建環評認證評級。

**暫定評級
不予評級**



申請編號: PAU0058/20

Estimated Energy Performance or Consumption for the Common Parts of the Development

發展項目的公用部份的預計能量表現或消耗

Latest information on the estimated energy performance or consumption for the common parts of the Development as submitted to the Building Authority prior to the printing of the sales brochures:

於印製售樓說明書前呈交予建築事務監督發展項目的公用部份的預計能量表現或消耗的最近期資料：

Part I 第 I 部分					
Provision of Central Air Conditioning 提供中央空調				Yes 是	
Provision of Energy Efficient Features 提供具能源效益的設施				Yes 是	
Energy Efficient Features proposed 擬安裝的具能源效益的設施	1. High Performance VRV and Split Unit 2. Central Water-cooled Air Conditioning System 3. CO sensor in carpark				
	1. 高效能可變製冷劑流量系統及分體式冷氣機 2. 水冷式中央空調系統 3. 停車場（配備一氧化碳監控裝置）				
Part II: The predicted annual energy use of the proposed building / part of building (Note 1) 第 II 部份：擬興建樓宇/部份樓宇預計每年能源消耗量（註腳1）					
Location 位置	Internal Floor Area Served (m2) 使用有關裝置的內部樓面面積（平方米）	Annual Energy Use of Baseline Building (Note 2) 基線樓宇（註腳2）每年能源消耗量		Annual Energy Use of Proposed Building 擬興建樓宇每年能源消耗量	
		Electricity kWh/m2/annum 電力 千瓦小時/平方米/年	Town Gas/LPG Unit/m2/annum 煤氣/石油氣 用量單位/平方米/年	Electricity kWh/m2/annum 電力 千瓦小時/平方米/年	Town Gas/LPG Unit/m2/annum 煤氣/石油氣 用量單位/平方米/年
Domestic Development Central Building Services Installation 住用發展項目中央屋宇裝置	9,634	203.8	N/A	192.2	N/A
Non-domestic Development Podium(s) (Central Building Services Installation) 非住用發展項目平台（中央屋宇裝置）	10,072	443.9	N/A	421.4	N/A

Part III: The following installation(s) is/are designed in accordance with the relevant Codes of Practices published by the Electrical & Mechanical Services Department (EMSD) 第 III 部份：以下裝置乃按機電工程署公布的相關實務守則設計			
Type of Installations 裝置類型	Yes 是	No 否	N/A 不適用
Lighting Installations 照明裝置	√		
Air Conditioning Installations 空調裝置	√		
Electrical Installations 電力裝置	√		
Lift & Escalator Installations 升降機及自動梯的裝置	√		
Performance-based Approach 以總能源為本的方法		√	

Notes:

- In general, the lower the estimated "Annual Energy Use" of the building, the more efficient of the building in terms of energy use. For example, if the estimated "annual energy use of proposed building" is less than the estimated "annual energy use of baseline building", it means the predicted use of energy is more efficient in the proposed building than in the baseline building. The larger the reduction, the greater the efficiency. The predicted annual energy use, in terms of electricity consumption (kWh/m²/annum) and town gas/LPG consumption (unit/m²/annum), of the Development by the internal floor area served, where:
 - "total annual energy use" has the same meaning of "annual energy use" under Section 4 and Appendix 8 of the BEAM Plus for New Buildings (current version); and
 - "internal floor area", in relation a building, a space or a unit means the floor area of all enclosed space measured to the internal faces of enclosing external and/or party walls.
- "Baseline Building" has the same meaning as "Baseline Building Model (zero-credit benchmark)" under Section 4 and Appendix 8 of the BEAM Plus for New Building (current version).
- "Central Building Services Installation" has the same meaning as that in the Code of Practice for Energy Efficiency of Building Services Installations in Buildings.

註腳：

- 一般而言，一棟樓宇的預計「每年能源消耗量」愈低，其節約能源的效益愈高。如一棟樓宇預計的「每年能源消耗量」低於該樓宇的「基線樓宇每年能源消耗量」，則代表預計該樓宇的能源應用較其基線樓宇有效，削減幅度愈大則代表有關樓宇能源節約的效益愈高。預計每年能源消耗量〔以耗電量（千瓦小時/平方米/年）及煤氣/石油氣消耗量（用量單位/平方米/年）計算〕，指將發展項目的每年能源消耗總量除以使用有關裝置的內部樓面面積所得出的商，其中：
 - 「每年能源消耗量」與新建樓宇BEAM Plus標準（現行版本）第4節及附錄8中的「年能源消耗」具有相同涵義；及
 - 樓宇、空間或單位的「內部樓面面積」，指外牆及/或共用牆的內壁之內表面起量度出來的樓面面積。
- 「基線樓宇」與新建樓宇BEAM Plus標準（現行版本）第4節及附錄8中的「基準建築物模式（零分標準）」具有相同涵義。
- 「中央屋宇裝備裝置」與樓宇的屋宇裝備裝置能源效益實務守則中的涵義相同。

1. The purchaser is required to agree with the Vendor in the Agreement for Sale and Purchase (“ASP”) to the effect that other than entering into a mortgage or charge, the purchaser will not nominate any person to take up the Assignment of the Residential Unit or the Parking Space specified in the ASP, sub-sell that Residential Unit or Parking Space or transfer the benefit of the ASP of that Residential Unit or Parking Space in any manner whatsoever or enter into any agreement so to do before completion of the sale and purchase and execution of the Assignment.
 2. If the Vendor, at the request of the purchaser under an ASP, agrees (at its own discretion) to cancel the ASP or the obligations of the purchaser under the ASP, the Vendor is entitled to retain the sum of five percent (5%) of the total purchase price of the Residential Unit and the Parking Space specified in the ASP and the purchaser will in addition pay or reimburse (as the case may be) to the Vendor all legal costs, charges and disbursements (including any stamp duty) in connection with the cancellation of the ASP.
 3. The Vendor will pay or has paid (as the case may be) all outstanding Government rent in respect of the land on which the Development is in the course of being erected, from the date of the Land Grant up to and including the date of the respective Assignments to the purchasers.
 4. The purchaser who has signed an ASP has the right of access to and will, upon his request, be provided with a hard copy of an updated record of information as to the total construction costs and the total professional fees to complete the Development as well as the total construction costs and the total professional fees expended and paid as at the end of the calendar month preceding the month at which the request is made subject to payment of a nominal fee of not more than HK\$100 per request.
 5. (I) Please refer to paragraphs 8, 9, 10 and 11 of the Summary of Land Grant for the Green Area and the Green Stippled Black Area as referred to in Special Condition Nos.(5), (6), (7) and (8) of the Government Grant.
(II) Please refer to paragraph 20 of the Summary of Land Grant for the Government Accommodation as referred to in Special Condition No.(18) of the Government Grant.
(III) Please refer to paragraph 31 of the Summary of Land Grant for the Mini Transport Interchange Reserved Area as referred to in Special Condition No.(31) of the Government Grant.
(IV) Please refer to paragraph 38(d) of the Summary of Land Grant for the Pedestrian Walkway as referred to in Special Condition No.(38)(d) of the Government Grant.
 6. Certain Residential Common Areas, marked “Access and Working Place for Drainage Pipe” and “Concrete Enclosure for Common Drainage Pipe” are located within the flat roofs of the 5th Floor of Towers 1, 2, 3 and 5 of the Development which have to be accessed through certain Residential Units on the 5th Floor of the Towers. Please refer to the Section “Floor Plans of Residential Properties in the Development” and the Section “Relevant Information” for more information.
1. 買方須於正式買賣合約下與賣方協議，除可用作按揭或押記外，買方不會於完成正式買賣合約之成交及簽立轉讓契之前，以任何方式或訂立任何協議，以達至提名任何人士接受轉讓正式買賣合約所指定的住宅物業或停車位，或轉讓該住宅物業或停車位，或轉移該住宅物業或停車位的正式買賣合約的權益。
 2. 如正式買賣合約的買方有此要求，並獲賣方（按其自己的酌情決定）同意之情況下取消正式買賣合約或買方於該正式買賣合約所承擔之責任，賣方有權保留相等於該正式買賣合約所指定的住宅物業及停車位總售價百分之五的款項。同時買方亦須額外付予賣方或付賣方（視屬何情況而定）全部就取消該正式買賣合約須付之律師費、收費及代墊付費用（包括任何須繳付之印花稅）。
 3. 賣方將會支付或已經支付（視屬何情況而定）由批地文件之日期起直至有關個別買方簽署轉讓契之日（包括簽署轉讓契當日）止，所有有關該正在興建的發展項目所處地段的地稅。
 4. 已簽署正式買賣合約的買方有權要求獲得一份有關完成興建發展項目所需的建築費用及專業費用總額的最新資料，以及直至該要求提出時的上一個公曆月底為止已動用及支付的建築費用及專業費用總額，並可於該要求提出及在支付不超過港幣一百元象徵式費用後獲得提供該資料的副本。
 5. (I) 有關批地文件特別批地條款第(5)、(6)、(7)及(8)條提及的綠色範圍及綠色加黑點範圍請見批地文件的摘要第8、9、10及11段。
(II) 有關批地文件特別批地條款第(18)條提及的政府樓宇請見批地文件的摘要第20段。
(III) 有關批地文件特別批地條款第(31)條提及的小型交通運輸交匯處專用範圍請見批地文件的摘要第31段。
(IV) 有關批地文件特別批地條款第(38)(d)條提及的行人走道請見批地文件的摘要第38(d)段。
 6. 某些住宅公用地方，以「排水管道維修空間」及「公共排水管道的混凝土圍封」標記位於發展項目第一座、第二座、第三座及第五座5樓平台內，並且需經由某些相關座的5樓住宅單位而進入。詳情請參閱「發展項目的住宅物業的樓面平面圖」部分及「有關資料」部分。

Date of printing of Sales Brochure:
29th September, 2021

售樓說明書印製日期：
2021年9月29日

There may be future changes to the Development and the surrounding areas.

發展項目及其周邊地區日後可能出現改變。

Examination/ Revision Date 檢視/修改日期	Page Number 頁數	Revision Made 所有修改
28th December 2021 二〇二一年十二月二十八日	11,13	Updated the 'INFORMATION ON DESIGN OF THE DEVELOPMENT' 更新「發展項目的設計的資料」
	20	Updated the 'OUTLINE ZONING PLAN ETC. RELATING TO THE DEVELOPMENT' 更新「關乎發展項目的分區計劃大綱圖等」
	22,23,24,26,28,30,32,34,36,38,40,42,44,46,48, 50,52,54,56,58-60,62,64,66,68,70	Updated the 'FLOOR PLANS OF RESIDENTIAL PROPERTIES IN THE DEVELOPMENT' 更新「發展項目的住宅物業的樓面平面圖」
	72,75,76,78,79,82,83,86	Updated the 'AREA OF RESIDENTIAL PROPERTIES IN THE DEVELOPMENT' 更新「發展項目的住宅物業的面積」
	87-92	Updated the 'FLOOR PLAN OF PARKING SPACES IN THE DEVELOPMENT' 更新「發展項目的停車位的樓面平面圖」
	153-156	Updated the 'ELEVATION PLAN' 更新「立面圖」
	173,174,176,177,180-186,190,192,193,195-203, 205-208,210-238,240-247	Updated the 'FITTINGS, FINISHES AND APPLIANCES' 更新「裝置、裝修物料及設備」
10th January 2022 二〇二二年一月十日	255	Updated the 'RELEVANT INFORMATION' 更新「有關資料」
31st March 2022 二〇二二年三月三十一日		No revision made 並無作出修改

