

# ELEVATION PLAN FOR THE PHASE 期數的立面圖

H T B

Tower 1  
第1座

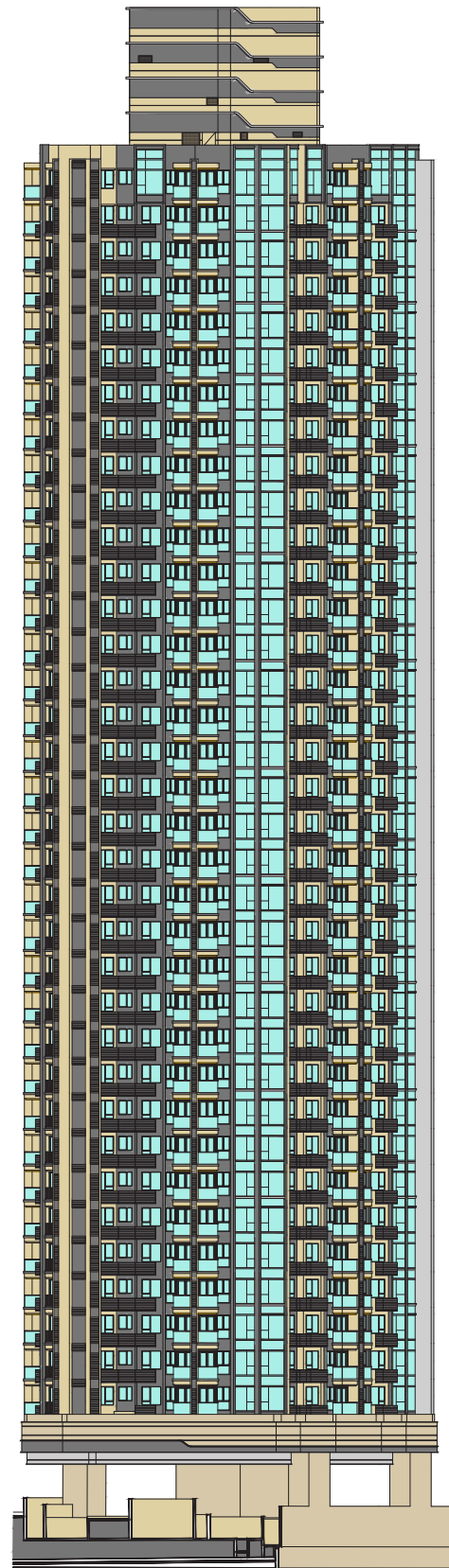

Elevation 1  
立面 1

Tower 1  
第1座



Elevation 2  
立面 2

KEY PLAN  
指示圖

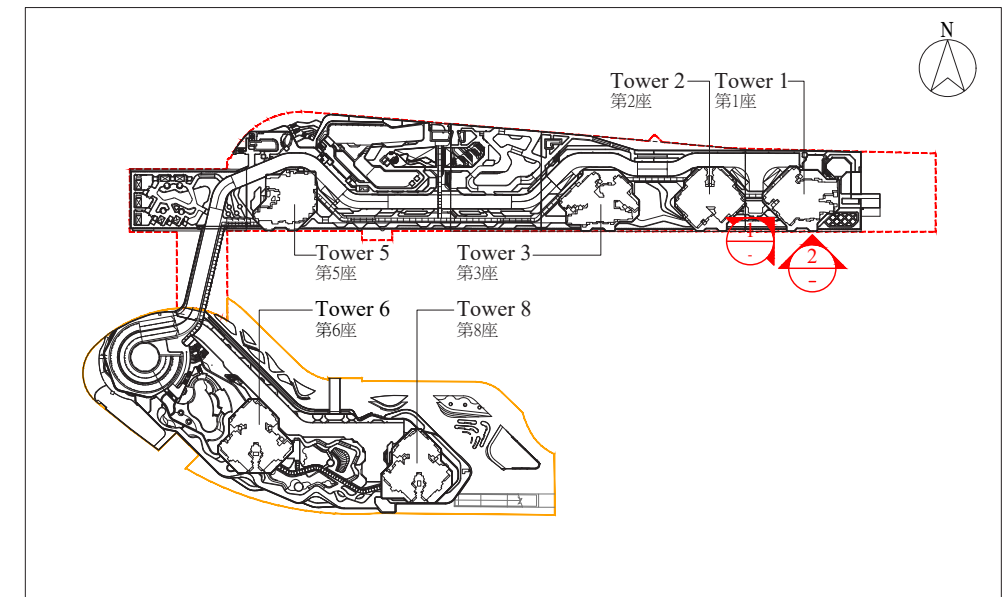

- The Phase  
期數
- Other Phase(s)  
其他期數

Authorized Person for the Phase certified that the elevations shown on this plan:

- (a) are prepared on the basis of the approved building plans for the Phase as of 30<sup>th</sup> November 2021 ; and
- (b) are in general accordance with the outward appearance of the Phase.

期數的認可人士證明本圖顯示的立面：

- (a) 以2021年11月30日的情況為準的期數的經批准的建築圖則為基礎擬備；及
- (b) 大致上與期數的外觀一致。

# ELEVATION PLAN FOR THE PHASE

## 期數的立面圖



Tower 1  
第1座

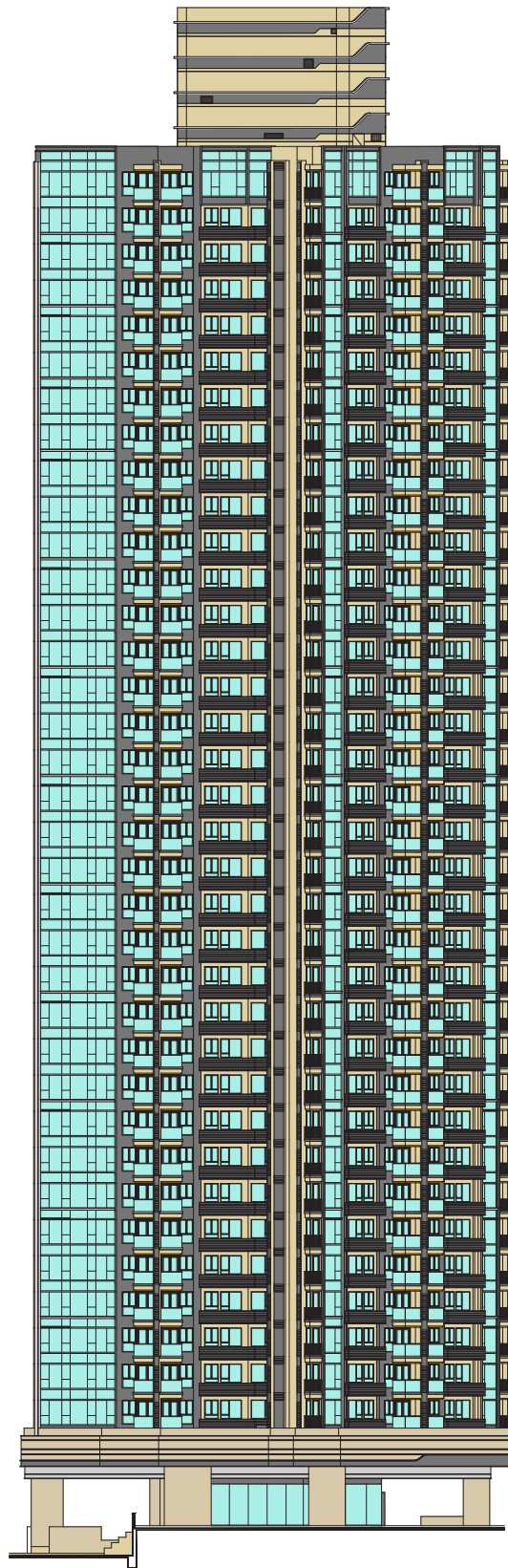

Elevation 3  
立面 3

Tower 1  
第1座



Elevation 4  
立面 4

KEY PLAN  
指示圖

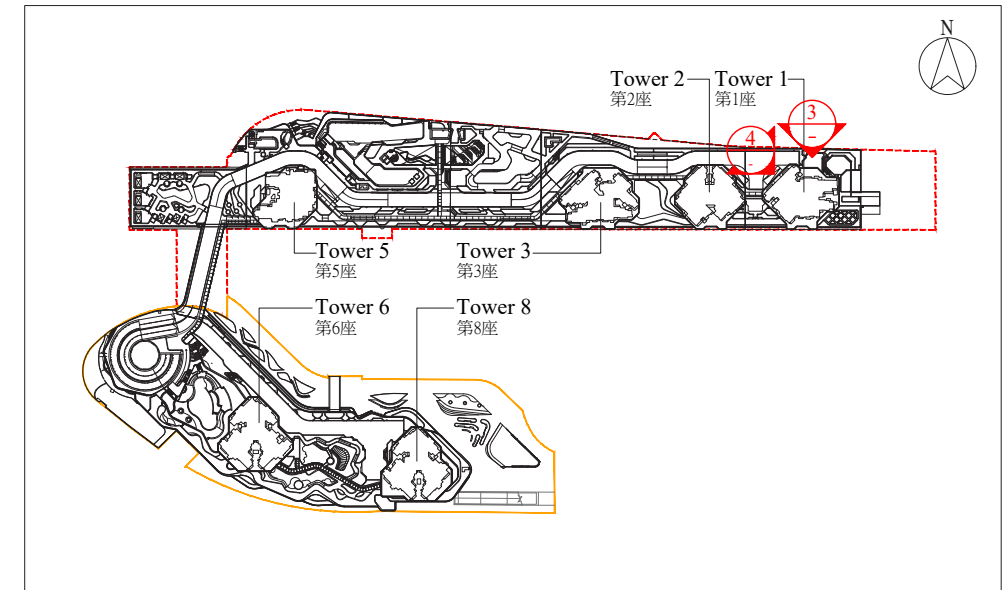

- The Phase  
期數
- Other Phase(s)  
其他期數

Authorized Person for the Phase certified that the elevations shown on this plan:

- (a) are prepared on the basis of the approved building plans for the Phase as of 30<sup>th</sup> November 2021 ; and
- (b) are in general accordance with the outward appearance of the Phase.

期數的認可人士證明本圖顯示的立面：

- (a) 以2021年11月30日的情況為準的期數的經批准的建築圖則為基礎擬備；及
- (b) 大致上與期數的外觀一致。

ELEVATION PLAN FOR THE PHASE  
期數的立面圖

H  
U  
B

Tower 1  
第1座



Elevation 5  
立面 5

KEY PLAN  
指示圖

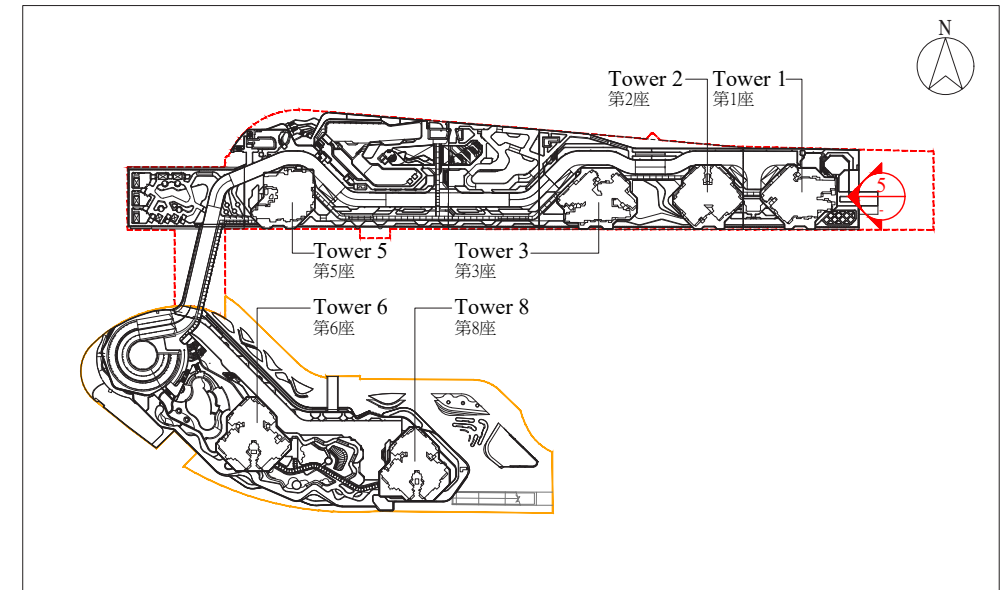

- The Phase  
期數
- Other Phase(s)  
其他期數

Authorized Person for the Phase certified that the elevations shown on this plan:

- (a) are prepared on the basis of the approved building plans for the Phase as of 30<sup>th</sup> November 2021 ; and
- (b) are in general accordance with the outward appearance of the Phase.

期數的認可人士證明本圖顯示的立面：

- (a) 以2021年11月30日的情況為準的期數的經批准的建築圖則為基礎擬備；及
- (b) 大致上與期數的外觀一致。



# ELEVATION PLAN FOR THE PHASE

## 期數的立面圖



Tower 2  
第2座



Elevation 1  
立面 1

Tower 2  
第2座



Elevation 2  
立面 2

KEY PLAN  
指示圖

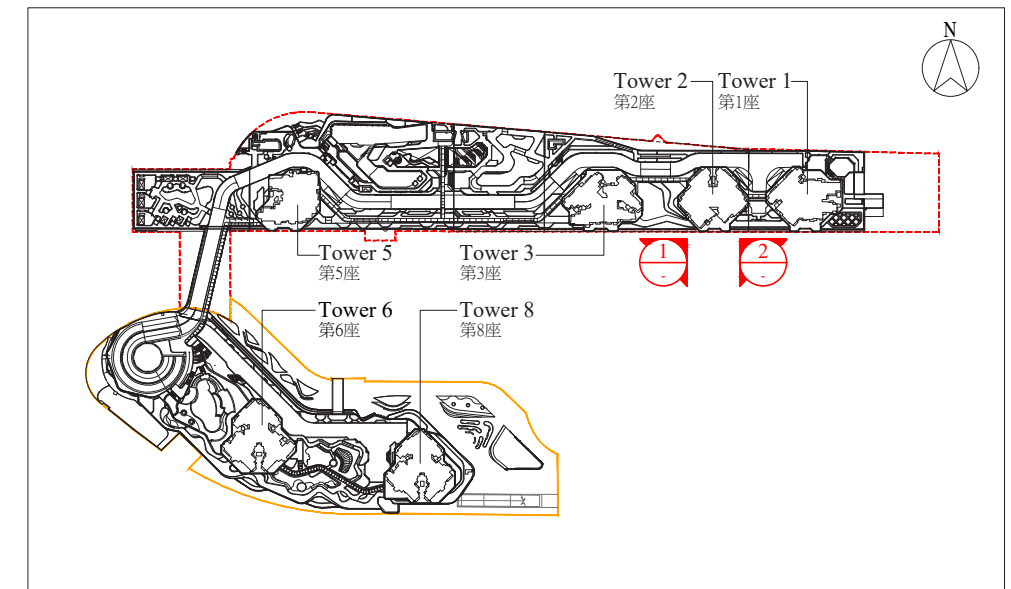

- The Phase  
期數
- Other Phase(s)  
其他期數

Authorized Person for the Phase certified that the elevations shown on this plan:

- (a) are prepared on the basis of the approved building plans for the Phase as of 30<sup>th</sup> November 2021 ; and
- (b) are in general accordance with the outward appearance of the Phase.

期數的認可人士證明本圖顯示的立面：

- (a) 以2021年11月30日的情況為準的期數的經批准的建築圖則為基礎擬備；及
- (b) 大致上與期數的外觀一致。

ELEVATION PLAN FOR THE PHASE  
期數的立面圖



Tower 2  
第2座

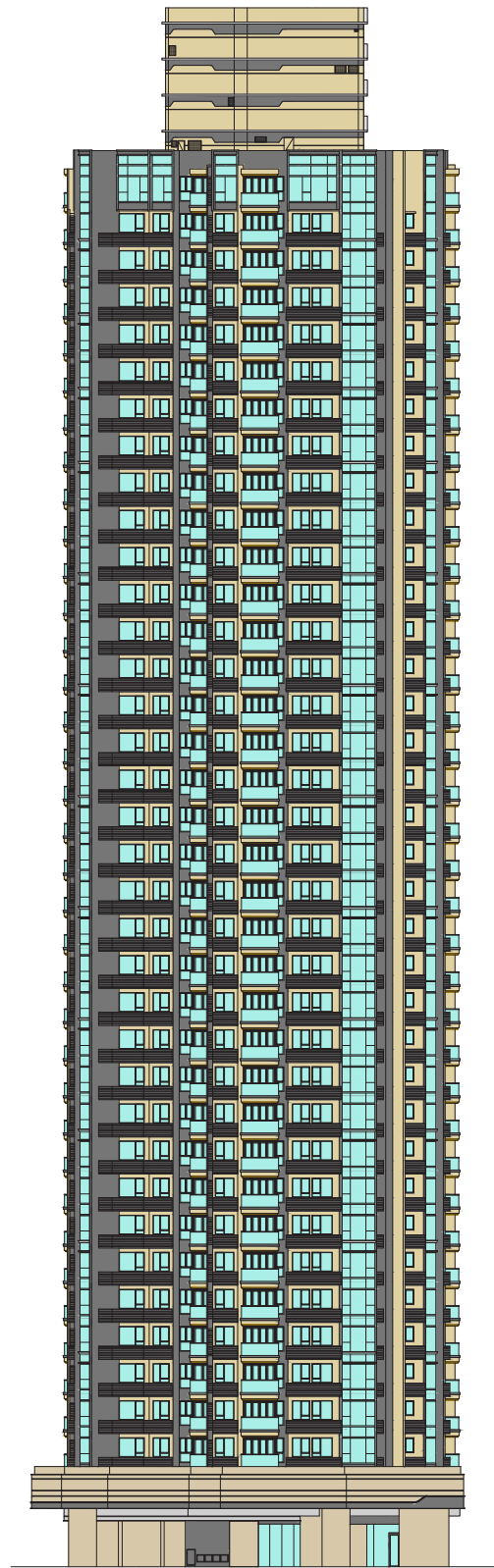

Elevation 3  
立面 3

Tower 2  
第2座

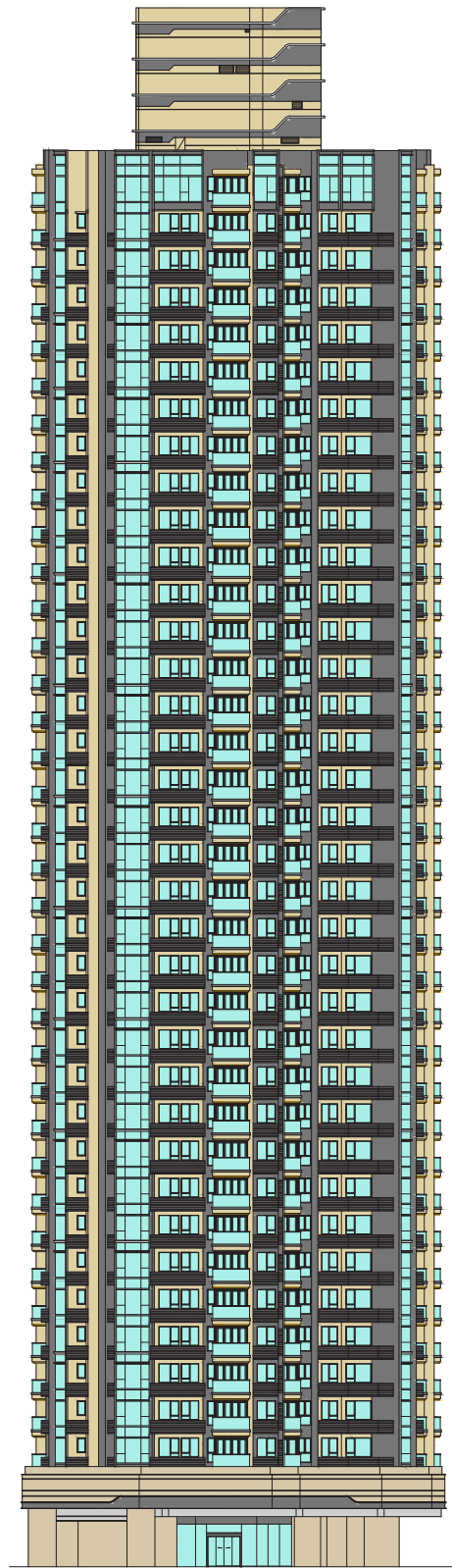

Elevation 4  
立面 4

KEY PLAN  
指示圖

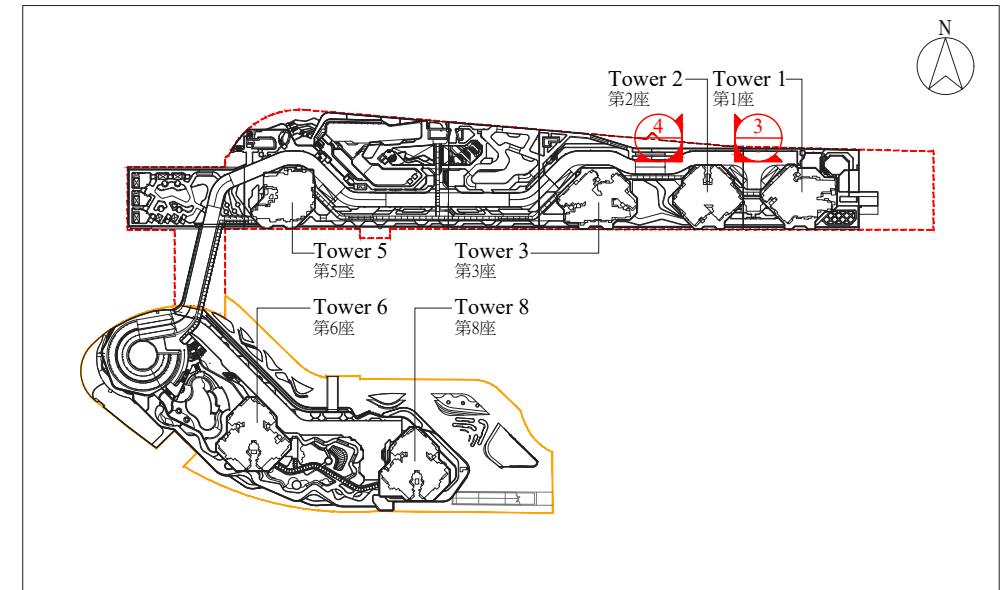

- The Phase  
期數
- Other Phase(s)  
其他期數

Authorized Person for the Phase certified that the elevations shown on this plan:

- (a) are prepared on the basis of the approved building plans for the Phase as of 30<sup>th</sup> November 2021 ; and
- (b) are in general accordance with the outward appearance of the Phase.

期數的認可人士證明本圖顯示的立面：

- (a) 以2021年11月30日的情況為準的期數的經批准的建築圖則為基礎擬備；及
- (b) 大致上與期數的外觀一致。

# ELEVATION PLAN FOR THE PHASE

## 期數的立面圖

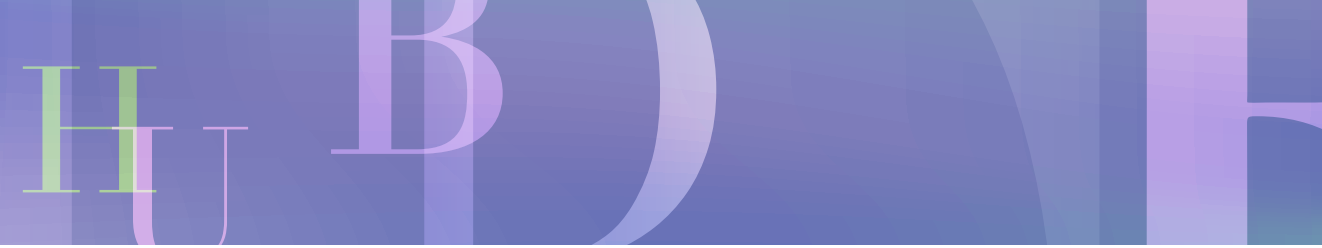

### KEY PLAN

#### 指示圖

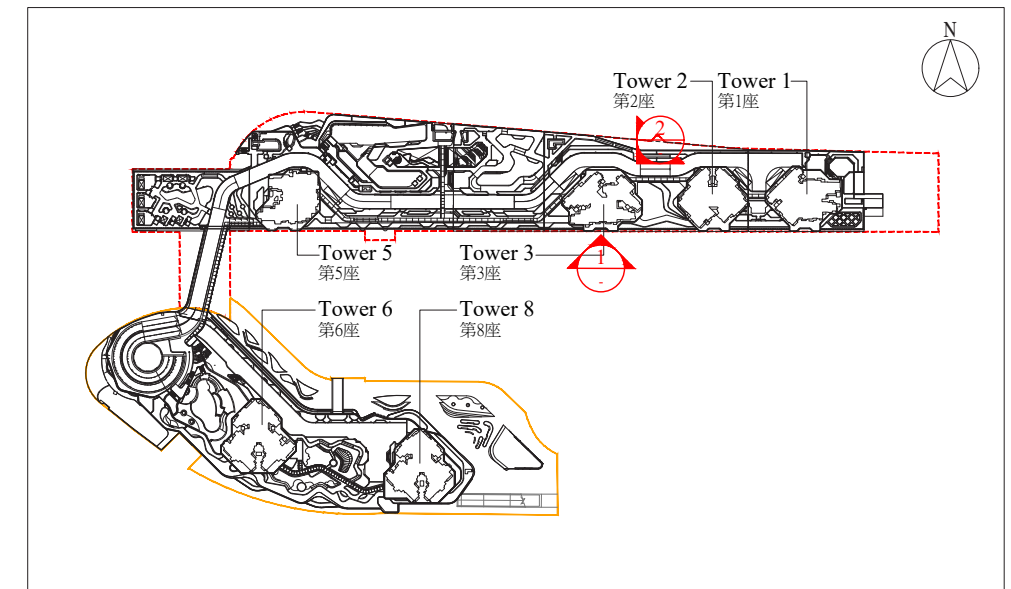

- The Phase  
期數
- Other Phase(s)  
其他期數

Tower 3  
第3座

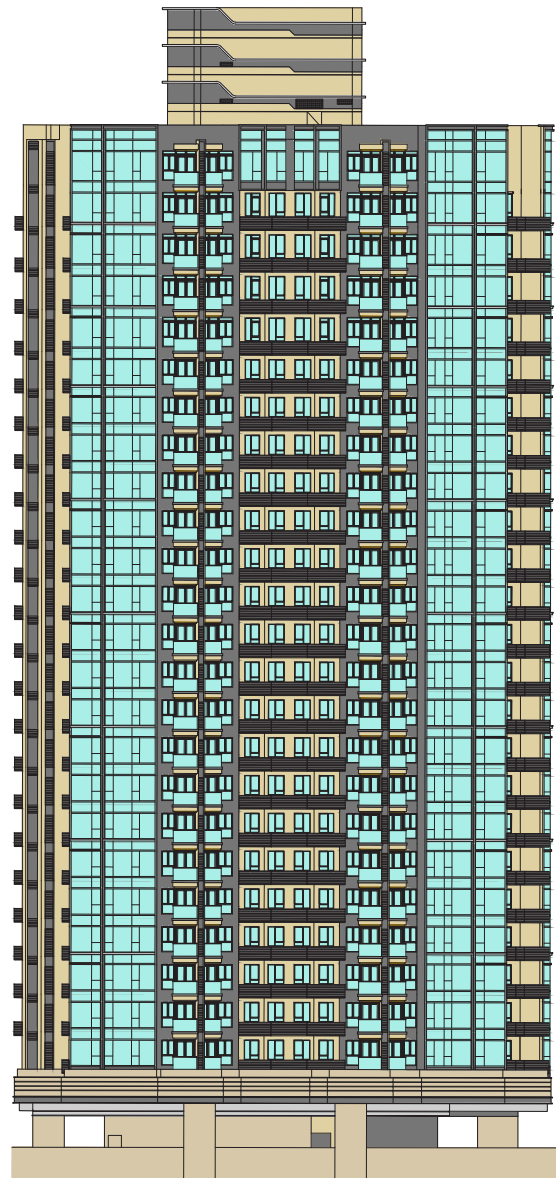

Elevation 1  
立面 1

Tower 3  
第3座

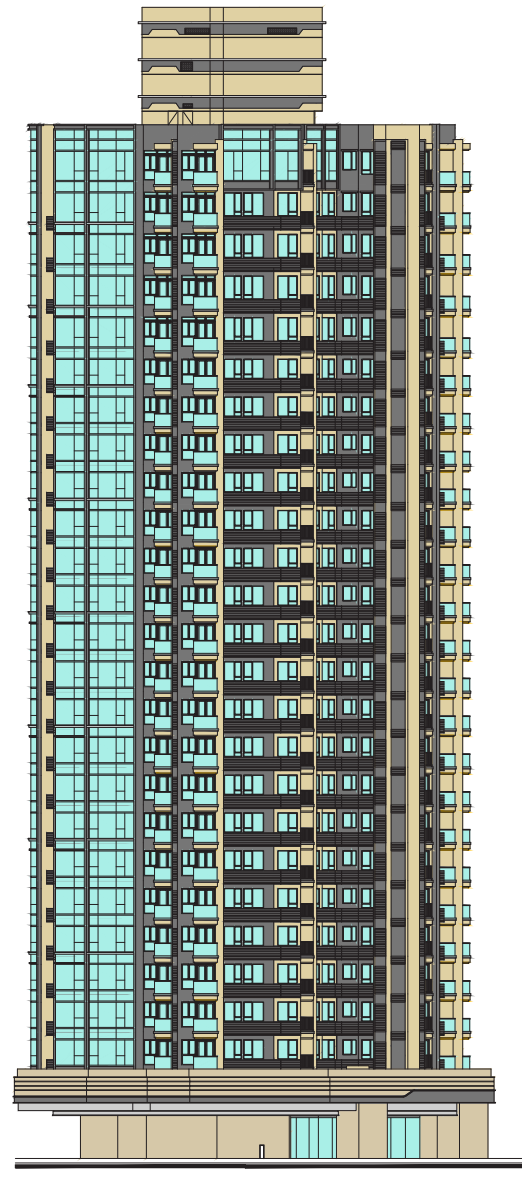

Elevation 2  
立面 2

Authorized Person for the Phase certified that the elevations shown on this plan:

- (a) are prepared on the basis of the approved building plans for the Phase as of 30<sup>th</sup> November 2021 ; and
- (b) are in general accordance with the outward appearance of the Phase.

期數的認可人士證明本圖顯示的立面：

- (a) 以2021年11月30日的情況為準的期數的經批准的建築圖則為基礎擬備；及
- (b) 大致上與期數的外觀一致。



ELEVATION PLAN FOR THE PHASE  
期數的立面圖

H  
U  
B

KEY PLAN  
指示圖

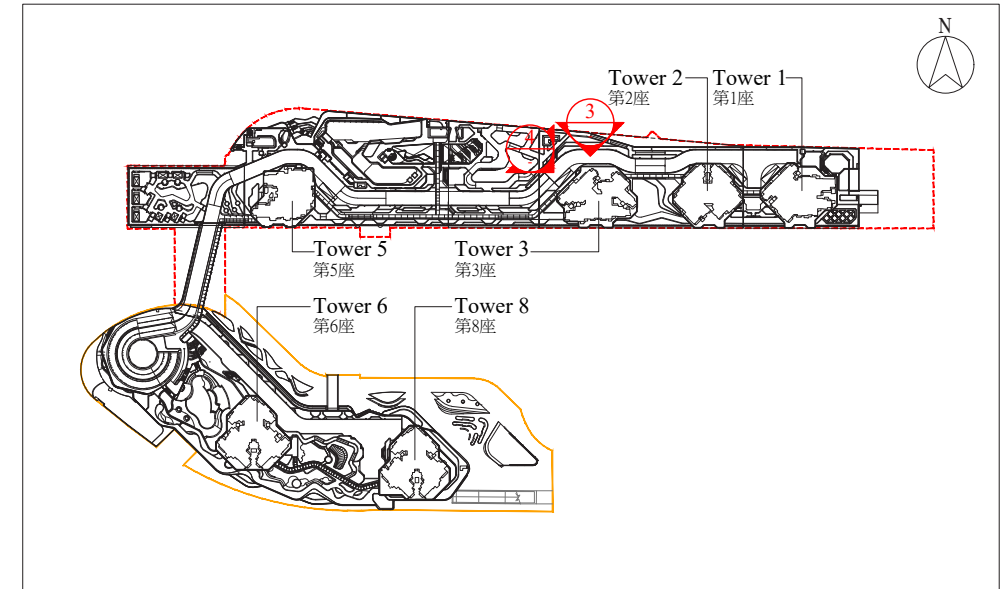

- The Phase  
期數
- Other Phase(s)  
其他期數

Tower 3  
第3座

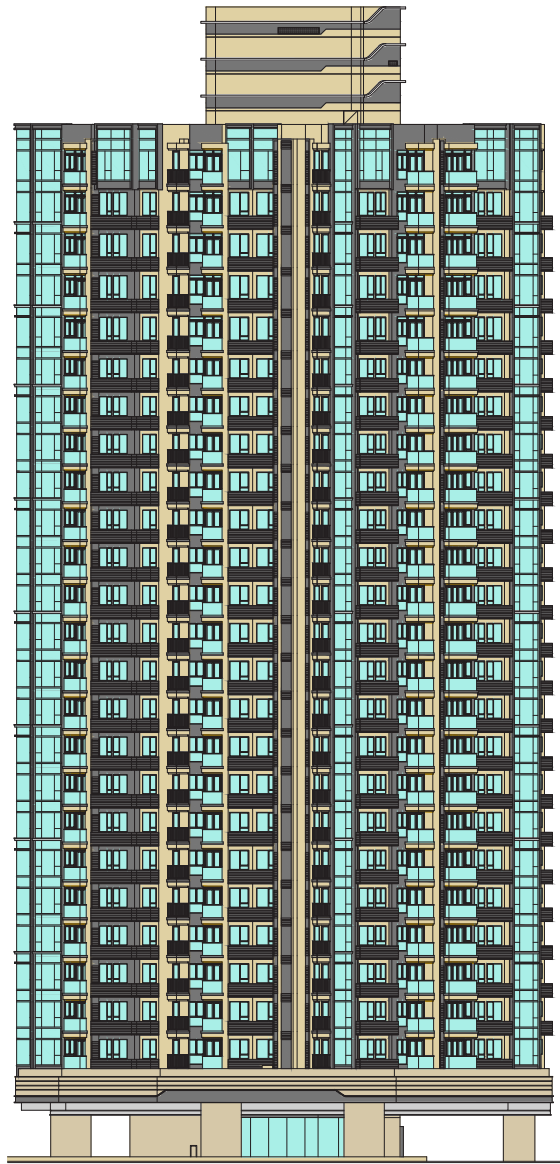

Elevation 3  
立面3

Tower 3  
第3座

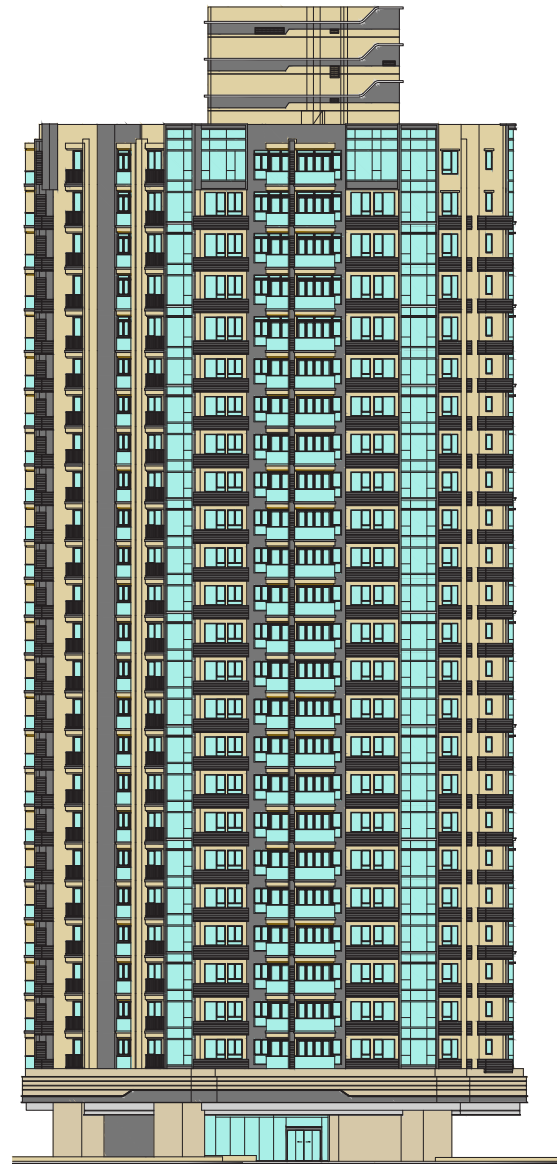

Elevation 4  
立面4

Authorized Person for the Phase certified that the elevations shown on this plan:

- (a) are prepared on the basis of the approved building plans for the Phase as of 30<sup>th</sup> November 2021 ; and
- (b) are in general accordance with the outward appearance of the Phase.

期數的認可人士證明本圖顯示的立面：

- (a) 以2021年11月30日的情況為準的期數的經批准的建築圖則為基礎擬備；及
- (b) 大致上與期數的外觀一致。

# ELEVATION PLAN FOR THE PHASE

## 期數的立面圖

H U B

Tower 5  
第 5 座

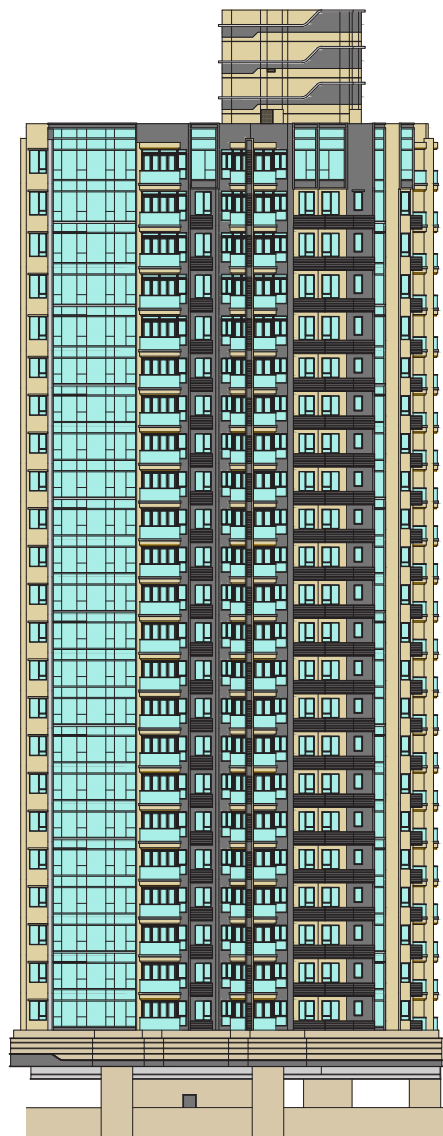

Elevation 1  
立面 1

Tower 5  
第 5 座

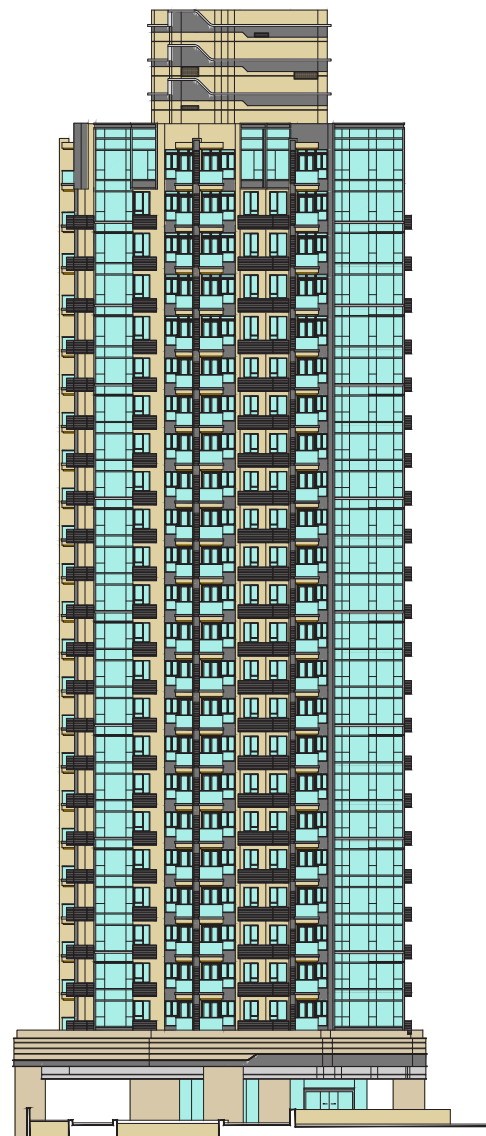

Elevation 2  
立面 2

KEY PLAN  
指示圖

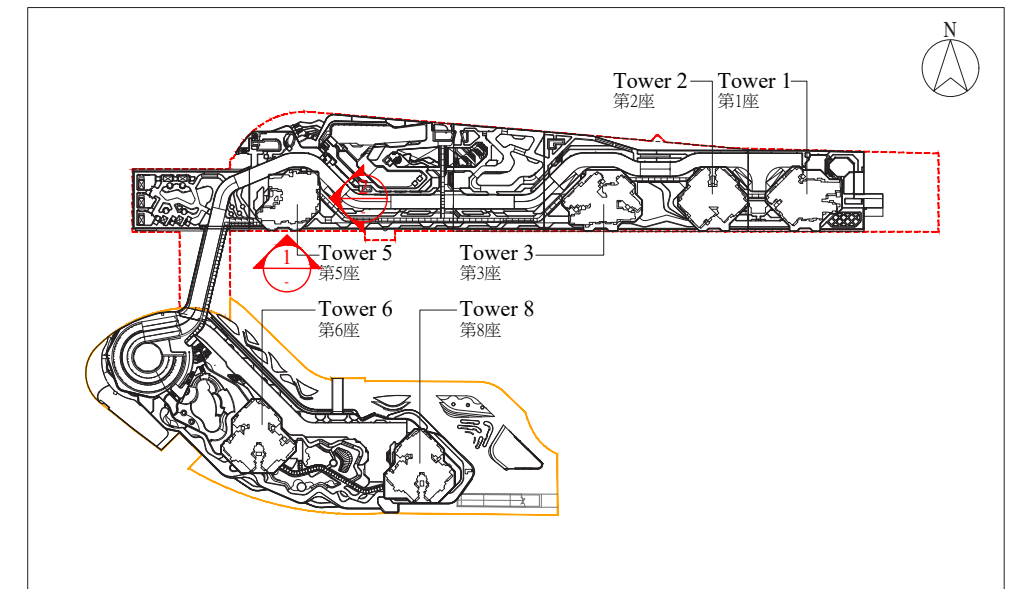

- The Phase  
期數
- Other Phase(s)  
其他期數

Authorized Person for the Phase certified that the elevations shown on this plan:

- (a) are prepared on the basis of the approved building plans for the Phase as of 30<sup>th</sup> November 2021 ; and
- (b) are in general accordance with the outward appearance of the Phase.

期數的認可人士證明本圖顯示的立面：

- (a) 以2021年11月30日的情況為準的期數的經批准的建築圖則為基礎擬備；及
- (b) 大致上與期數的外觀一致。



ELEVATION PLAN FOR THE PHASE  
期數的立面圖

H U B

Tower 5  
第 5 座

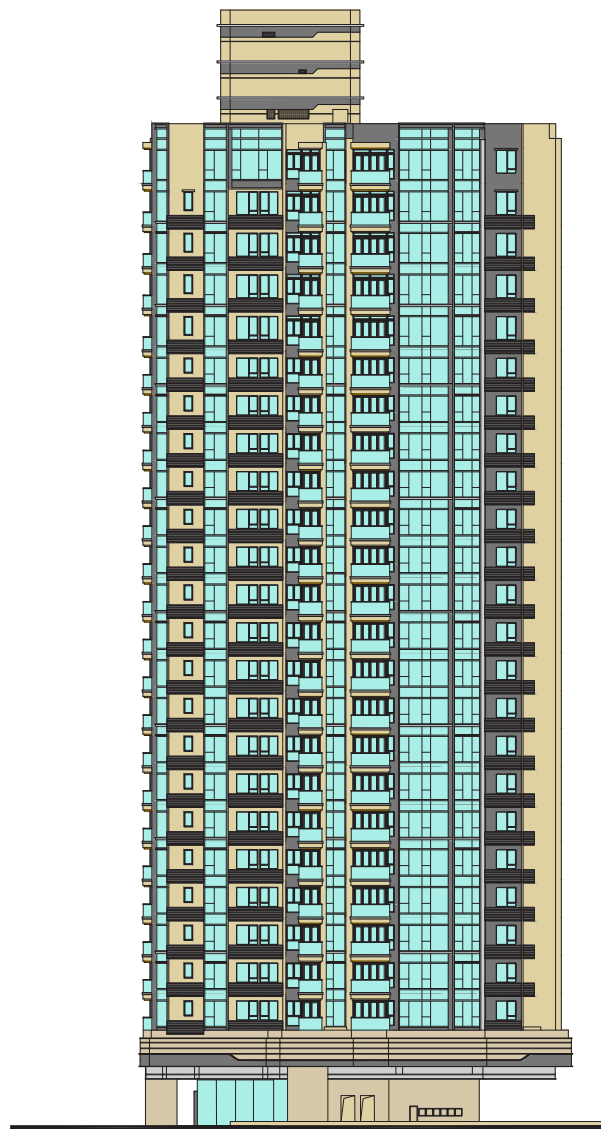

Elevation 3  
立面 3

Tower 5  
第 5 座

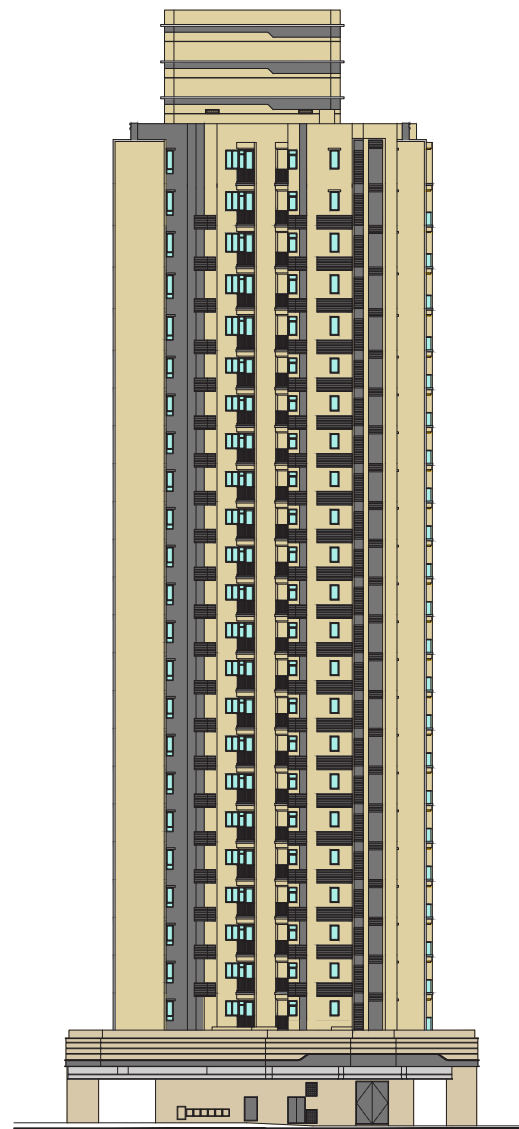

Elevation 4  
立面 4

KEY PLAN  
指示圖

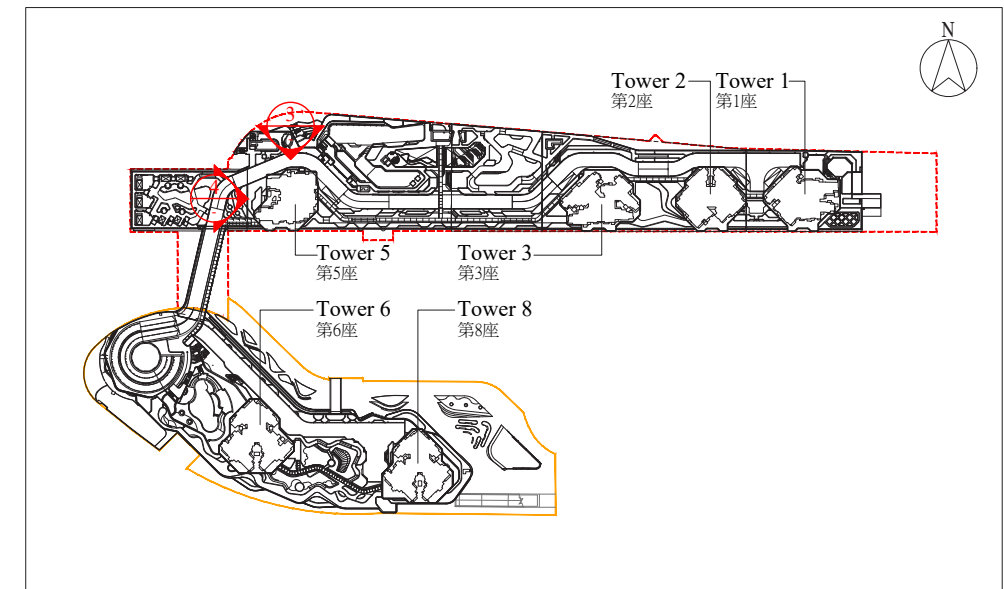

- The Phase  
期數
- Other Phase(s)  
其他期數

Authorized Person for the Phase certified that the elevations shown on this plan:

- (a) are prepared on the basis of the approved building plans for the Phase as of 30<sup>th</sup> November 2021 ; and
- (b) are in general accordance with the outward appearance of the Phase.

期數的認可人士證明本圖顯示的立面：

- (a) 以2021年11月30日的情況為準的期數的經批准的建築圖則為基礎擬備；及
- (b) 大致上與期數的外觀一致。