

The Pavilia Farm

柏傲莊

The Pavilia Farm II • 柏傲莊 II



SALES BROCHURE
售樓說明書



The Pavilia Farm

柏 傲 莊

The Pavilia Farm II • 柏傲莊II

Notes to purchasers of first-hand residential properties

一手住宅物業買家須知

You are advised to take the following steps before purchasing first-hand residential properties.

For all first-hand residential properties

I. Important information

- Make reference to the materials available on the Sales of First-hand Residential Properties Electronic Platform (SRPE) (www.srpe.gov.hk) on the first-hand residential property market.
- Study the information on the website designated by the vendor for the development, including the sales brochure, price lists, documents containing the sales arrangements, and the register of transactions of a development.
- Sales brochure for a development will be made available to the general public at least 7 days immediately before a date of sale while price list and sales arrangements will be made available at least 3 days immediately before the date of sale.
- Information on transactions can be found on the register of transactions on the website designated by the vendor for the development and the SRPE.

2. Fees, mortgage loan and property price

- Calculate the total expenses of the purchase, such as solicitors' fees, mortgage charges, insurance fees and stamp duties.
- Check with banks to find out if you will be able to obtain the needed mortgage loan, select the appropriate payment method and calculate the amount of the mortgage loan to ensure it is within your repayment ability.
- Check recent transaction prices of comparable properties for comparison.
- Check with the vendor or the estate agent the estimated management fee, the amount of management fee payable in advance (if any), special fund payable (if any), the amount of reimbursement of the deposits for water, electricity and gas (if any), and/or the amount of debris removal fee (if any) you have to pay to the vendor or the manager of the development.

3. Price list, payment terms and other financial incentives

- Vendors may not offer to sell all the residential properties that are covered in a price list. To know which residential properties the vendors may offer to sell, pay attention to the sales arrangements which will be announced by the vendors at least 3 days before the relevant residential properties are offered to be sold.
- Pay attention to the terms of payment as set out in a price list. If there are discounts on the price, gift, or any financial advantage or benefit to be made available in connection with the purchase of the residential properties, such information will also be set out in the price list.

- If you intend to opt for any mortgage loan plans offered by financial institutions specified by the vendor, before entering into a preliminary agreement for sale and purchase (PASP), you must study the details of various mortgage loan plans¹ as set out in the price list concerned. If you have any questions about these mortgage loan plans, you should check with the financial institutions concerned direct before entering into a PASP.

4. Property area and its surroundings

- Pay attention to the area information in the sales brochure and price list, and price per square foot/metre in the price list. According to the Residential Properties (First-hand Sales) Ordinance (Cap. 621) (the Ordinance), vendors can only present the area and price per square foot and per square metre of a residential property using saleable area. Saleable area, in relation to a residential property, means the floor area of the residential property, and includes the floor area of every one of the following to the extent that it forms part of the residential property - (i) a balcony; (ii) a utility platform; and (iii) a verandah. The saleable area excludes the area of the following which forms part of the residential property - air-conditioning plant room; bay window; cockloft; flat roof; garden; parking space; roof; stairhood; terrace and yard.
- Floor plans of all residential properties in the development have to be shown in the sales brochure. In a sales brochure, floor plans of residential properties in the development must state the external and internal dimensions of each residential property². The external and internal dimensions of residential properties as provided in the sales brochure exclude plaster and finishes. You are advised to note this if you want to buy furniture before handing over of the residential property.
- Visit the development site and get to know the surroundings of the property (including transportation and community facilities). Check town planning proposals and decisions which may affect the property. Take a look at the location plan, aerial photograph, outline zoning plan and cross-section plan that are provided in the sales brochure.

¹ The details of various mortgage loan plans include the requirements for mortgagors on minimum income level, the loan limit under the first mortgage and second mortgage, the maximum loan repayment period, the change of mortgage interest rate throughout the entire repayment period, and the payment of administrative fees.

² According to section 10(2)(d) in Part 1 of Schedule 1 to the Ordinance, each of the floor plans of the residential properties in the development in the sales brochure must state the following—
(i) the external dimensions of each residential property;
(ii) the internal dimensions of each residential property;
(iii) the thickness of the internal partitions of each residential property;
(iv) the external dimensions of individual compartments in each residential property.
According to section 10(3) in Part 1 of Schedule 1 to the Ordinance, if any information required by section 10(2)(d) in Part 1 of Schedule 1 to the Ordinance is provided in the approved building plans for the development, a floor plan must state the information as so provided.

Notes to purchasers of first-hand residential properties

一手住宅物業買家須知

5. Sales brochure

- Ensure that the sales brochure you have obtained is the latest version. According to the Ordinance, the sales brochure made available to the public should be printed or examined, or examined and revised within the previous 3 months.
- Read through the sales brochure and in particular, check the following information in the sales brochure -
 - whether there is a section on "relevant information" in the sales brochure, under which information on any matter that is known to the vendor but is not known to the general public, and is likely to materially affect the enjoyment of a residential property will be set out. Please note that information contained in a document that has been registered with the Land Registry will not be regarded as "relevant information";
 - the cross-section plan showing a cross-section of the building in relation to every street adjacent to the building, and the level of every such street in relation to a known datum and to the level of the lowest residential floor of the building. This will help you visualize the difference in height between the lowest residential floor of a building and the street level, regardless of how that lowest residential floor is named;
 - interior and exterior fittings and finishes and appliances;
 - the basis on which management fees are shared;
 - whether individual owners have obligations or need to share the expenses for managing, operating and maintaining the public open space or public facilities inside or outside the development, and the location of the public open space or public facilities; and
 - whether individual owners have responsibility to maintain slopes.

6. Government land grant and deed of mutual covenant (DMC)

- Read the Government land grant and the DMC (or the draft DMC). Information such as ownership of the rooftop and external walls can be found in the DMC. The vendor will provide copies of the Government land grant and the DMC (or the draft DMC) at the place where the sale is to take place for free inspection by prospective purchasers.
- Check the Government land grant on whether individual owners are liable to pay Government rent.
- Check the DMC on whether animals can be kept in the residential property.

7. Information on Availability of Residential Properties for Selection at Sales Office

- Check with the vendor which residential properties are available for selection. If a "consumption table" is displayed by the vendor at the sales office, you may check from the table information on the progress of sale on a date of sale, including which residential properties are offered for sale at the beginning of that date of sale and which of them have been selected and sold during that date of sale.
- Do not believe in rumours about the sales condition of the development and enter into a PASP rashly.

8. Register of Transactions

- Pay attention to the register of transactions for a development. A vendor must, within 24 hours after entering into a PASP with a purchaser, enter transaction information of the PASP in the register of transactions. The vendor must, within 1 working day after entering into an agreement for sale and purchase (ASP), enter transaction information of the ASP in the register of transactions. Check the register of transactions for the concerned development to learn more about the sales condition of the development.
- Never take the number of registrations of intent or cashier orders a vendor has received for the purpose of registration as an indicator of the sales volume of a development. The register of transactions for a development is the most reliable source of information from which members of the public can grasp the daily sales condition of the development.

9. Agreement for sale and purchase

- Ensure that the PASP and ASP include the mandatory provisions as required by the Ordinance.
- Pay attention that fittings, finishes and appliances to be included in the sale and purchase of the property are inserted in the PASP and ASP.
- Pay attention to the area plan annexed to the ASP which shows the total area which the vendor is selling to you. The total area which the vendor is selling to you is normally greater than the saleable area of the property.
- A preliminary deposit of **5%** of the purchase price is payable by you to the owner (i.e. the seller) on entering into a PASP.
- If you do not execute the ASP within **5 working days** (working day means a day that is not a general holiday or a Saturday or a black rainstorm warning day or gale warning day) after entering into the PASP, the PASP is terminated, the preliminary deposit (i.e. 5% of the purchase price) is forfeited, and the owner (i.e. the seller) does not have any further claim against you for not executing the ASP.
- If you execute the ASP within 5 working days after the signing of the PASP, the owner (i.e. the seller) must execute the ASP within 8 working days after entering into the PASP.
- The deposit should be made payable to the solicitors' firm responsible for stakeholding purchasers' payments for the property.

10. Expression of intent of purchasing a residential property

- Note that vendors (including their authorized representative(s)) should not seek or accept any specific or general expression of intent of purchasing any residential property before the relevant price lists for such properties are made available to the public. You therefore should not make such an offer to the vendors or their authorized representative(s).
- Note that vendors (including their authorized representative(s)) should not seek or accept any specific expression of intent of purchasing a particular residential property before the sale of the property has commenced. You therefore should not make such an offer to the vendors or their authorized representative(s).

Notes to purchasers of first-hand residential properties

一手住宅物業買家須知

11. Appointment of estate agent

- Note that if the vendor has appointed one or more than one estate agents to act in the sale of any specified residential property in the development, the price list for the development must set out the name of all the estate agents so appointed as at the date of printing of the price list.
- You may appoint any estate agent (not necessarily from those estate agency companies appointed by the vendor) to act in the purchase of any specified residential property in the development, and may also not appoint any estate agent to act on your behalf.
- Before you appoint an estate agent to look for a property, you should -
 - find out whether the agent will act on your behalf only. If the agent also acts for the vendor, he/she may not be able to protect your best interests in the event of a conflict of interest;
 - find out whether any commission is payable by you to the estate agent and, if so, its amount and the time of payment; and
 - note that only licensed estate agents or salespersons may accept your appointment. If in doubt, you should request the estate agent or salesperson to produce his/her Estate Agent Card, or check the Licence List on the Estate Agents Authority website: www.eaa.org.hk.

12. Appointment of solicitor

- Consider appointing your own solicitor to protect your interests. If the solicitor also acts for the vendor, he/she may not be able to protect your best interests in the event of a conflict of interest.
- Compare the charges of different solicitors.

For first-hand uncompleted residential properties

13. Pre-sale Consent

- For uncompleted residential property under the Lands Department Consent Scheme, seek confirmation from the vendor whether the "Pre-sale Consent" has been issued by the Lands Department for the development.

14. Show flats

- While the vendor is not required to make any show flat available for viewing by prospective purchasers or the general public, if the vendor wishes to make available show flats of a specified residential property, the vendor must first of all make available an unmodified show flat of that residential property and that, having made available such unmodified show flat, the vendor may then make available a modified show flat of that residential property. In this connection, the vendor is allowed to make available more than one modified show flat of that residential property.
- If you visit the show flats, you should always look at the unmodified show flats for comparison with the modified show flats. That said, the Ordinance does not restrict the discretion of the vendor in arranging the sequence of the viewing of unmodified and modified show flats.
- Sales brochure of the development should have been made available to the public when the show flat is made available for viewing. You are advised to get a copy of the sales brochure and make reference to it when viewing the show flats.
- You may take measurements in modified and unmodified show flats, and take photographs or make video recordings of unmodified show flats, subject to reasonable restriction(s) which may be set by the vendor for ensuring safety of the persons viewing the show flat.

For first-hand uncompleted residential properties and completed residential properties pending compliance

15. Estimated material date and handing over date

- Check the estimated material date³ for the development in the sales brochure.
 - The estimated material date for a development in the sales brochure is not the same as the date on which a residential property is handed over to purchaser. The latter is inevitably later than the former.

³ Generally speaking, "material date" means the date on which the conditions of the land grant are complied with in respect of the development, or the date on which the development is completed in all respects in compliance with the approved building plans or the conditions subject to which the certificate of exemption is issued. For details, please refer to section 2 of the Ordinance.

Notes to purchasers of first-hand residential properties

一手住宅物業買家須知

- Handing over date
 - The mandatory provisions to be incorporated in an ASP as required by the Ordinance include a provision requiring the vendor to apply in writing for an Occupation Document/a Certificate of Compliance or the Director of Lands' Consent to Assign (as the case may be) in respect of the development within 14 days after the estimated material date as stipulated in the ASP.
 - For development subject to the Lands Department Consent Scheme, the vendor is required to notify the purchaser in writing that the vendor is in a position validly to assign the property within one month after the issue of the Certificate of Compliance or the Consent to Assign, whichever first happens; or
 - For development not subject to the Lands Department Consent Scheme, the vendor is required to notify the purchaser in writing that the vendor is in a position validly to assign the property within 6 months after the issue of the Occupation Document including Occupation Permit.
 - The mandatory provisions to be incorporated in an ASP as required by the Ordinance include a provision requiring completion of the sale and purchase within 14 days after the date of the notification aforesaid. Upon completion, the vendor shall arrange handover of the property to the purchaser.
- Authorized Person (AP) may grant extension(s) of time for completion of the development beyond the estimated material date.
 - The mandatory provisions to be incorporated in an ASP as required by the Ordinance include a provision that the AP of a development may grant an extension of time for completion of the development beyond the estimated material date having regard to delays caused exclusively by any one or more of the following reasons:
 - strike or lock-out of workmen;
 - riots or civil commotion;
 - force majeure or Act of God;
 - fire or other accident beyond the vendor's control;
 - war; or
 - inclement weather.
 - The AP may grant more than once such an extension of time depending on the circumstances. That means handover of the property may be delayed.
 - The mandatory provisions to be incorporated in an ASP as required by the Ordinance also include a provision requiring the vendor to, within 14 days after the issue of an extension of time granted by the AP, furnish the purchaser with a copy of the relevant certificate of extension.
- Ask the vendor if there are any questions on handing over date.

For first-hand completed residential properties

16. Vendor's information form

- Ensure that you obtain the "vendor's information form(s)" printed within the previous 3 months in relation to the residential property/properties you intend to purchase.

17. Viewing of property

- Ensure that, before you purchase a residential property, you are arranged to view the residential property that you would like to purchase or, if it is not reasonably practicable to view the property in question, a comparable property in the development, unless you agree in writing that the vendor is not required to arrange such a comparable property for viewing for you. You are advised to think carefully before signing any waiver.
- You may take measurements, take photographs or make video recordings of the property, unless the property is held under a tenancy or reasonable restriction(s) is/are needed to ensure safety of the persons viewing the property.

For complaints and enquiries relating to the sales of first-hand residential properties by the vendors which the Ordinance applies, please contact the Sales of First-hand Residential Properties Authority -

Website	: www.srpa.gov.hk
Telephone	: 2817 3313
Email	: enquiry_srpa@hd.gov.hk
Fax	: 2219 2220

Other useful contacts:

Consumer Council	
Website	: www.consumer.org.hk
Telephone	: 2929 2222
Email	: cc@consumer.org.hk
Fax	: 2856 3611

Estate Agents Authority	
Website	: www.eaa.org.hk
Telephone	: 2111 2777
Email	: enquiry@eaa.org.hk
Fax	: 2598 9596

Real Estate Developers Association of Hong Kong	
Telephone	: 2826 0111
Fax	: 2845 2521

Sales of First-hand Residential Properties Authority
Transport and Housing Bureau
August 2017

Notes to purchasers of first-hand residential properties

一手住宅物業買家須知

您在購置一手住宅物業之前，應留意下列事項：

適用於所有一手住宅物業

1. 重要資訊

- 瀏覽一手住宅物業銷售資訊網（下稱「銷售資訊網」）（網址：www.srpe.gov.hk），參考「銷售資訊網」內有關一手住宅物業的市場資料。
- 閱覽賣方就該發展項目所指定的互聯網網站內的有關資訊，包括售樓說明書、價單、載有銷售安排的文件，及成交紀錄冊。
- 發展項目的售樓說明書，會在該項目的出售日期前最少七日向公眾發布，而有關價單和銷售安排，亦會在該項目的出售日期前最少三日公布。
- 在賣方就有關發展項目所指定的互聯網網站，以及「銷售資訊網」內，均載有有關物業成交資料的成交紀錄冊，以供查閱。

2. 費用、按揭貸款和樓價

- 計算置業總開支，包括律師費、按揭費用、保險費，以及印花稅。
- 向銀行查詢可否取得所需的按揭貸款，然後選擇合適的還款方式，並小心計算按揭貸款金額，以確保貸款額沒有超出本身的負擔能力。
- 查閱同類物業最近的成交價格，以作比較。
- 向賣方或地產代理瞭解，您須付予賣方或該發展項目的管理人的預計的管理費、管理費上期金額(如有)、特別基金金額(如有)、補還的水、電力及氣體按金(如有)、以及 / 或清理廢料的費用(如有)。

3. 價單、支付條款，以及其他財務優惠

- 賣方未必會把價單所涵蓋的住宅物業悉數推售，因此應留意有關的銷售安排，以了解賣方會推售的住宅物業為何。賣方會在有關住宅物業推售日期前最少三日公布銷售安排。
- 留意價單所載列的支付條款。倘買家可就購置有關住宅物業而連帶獲得價格折扣、贈品，或任何財務優惠或利益，上述資訊亦會在價單內列明。
- 如您擬選用由賣方指定的財務機構提供的各類按揭貸款計劃，在簽訂臨時買賣合約前，應先細閱有關價單內列出的按揭貸款計劃資料¹。如就該些按揭貸款計劃的詳情有任何疑問，應在簽訂臨時買賣合約前，直接向有關財務機構查詢。

4. 物業的面積及四周環境

- 留意載於售樓說明書和價單內的物業面積資料，以及載於價單內的每平方呎 / 每平方米售價。根據《一手住宅物業銷售條例》(第621章)(下稱「條例」)，賣方只可以實用面積表達住宅物業的面積和每平方呎及平方米的售價。就住宅物業而言，實用面積指該住宅物業的樓面面積，包括在構成該物業的一部分的範圍內的以下每一項目的樓面面積：(i)露台；(ii)工作平台；以及(iii)陽台。實用面積並不包括空調機房、窗台、閣樓、平台、花園、停車位、天台、梯屋、前庭或庭院的每一項目的面積，即使該些項目構成該物業的一部分的範圍。
- 售樓說明書必須顯示發展項目中所有住宅物業的樓面平面圖。在售樓說明書所載有關發展項目中住宅物業的每一份樓面平面圖，均須述明每個住宅物業的外部 and 內部尺寸²。售樓說明書所提供有關住宅物業外部和內部的尺寸，不會把批盪和裝飾物料包括在內。買家收樓前如欲購置家具，應留意這點。
- 親臨發展項目的所在地實地視察，以了解有關物業的四周環境(包括交通和社區設施)；亦應查詢有否任何城市規劃方案和議決，會對有關的物業造成影響；參閱載於售樓說明書內的位置圖、鳥瞰照片、分區計劃大綱圖，以及橫截面圖。

¹ 按揭貸款計劃的資料包括有關按揭貸款計劃對借款人的最低收入的要求、就第一按揭連同第二按揭可獲得的按揭貸款金額上限、最長還款年期、整個還款期內的按揭利率變化，以及申請人須繳付的手續費。

² 根據條例附表1第1部第10(2)(d)條述明，售樓說明書內顯示的發展項目中的住宅物業的每一份樓面平面圖須述明以下各項—

- (i) 每個住宅物業的外部尺寸；
- (ii) 每個住宅物業的內部尺寸；
- (iii) 每個住宅物業的內部間隔的厚度；
- (iv) 每個住宅物業內個別分隔室的外部尺寸。

根據條例附表1第1部第10(3)條，如有關發展項目的經批准的建築圖則，提供條例附表1第1部第10(2)(d)條所規定的資料，樓面平面圖須述明如此規定的該資料。

Notes to purchasers of first-hand residential properties

一手住宅物業買家須知

5. 售樓說明書

- 確保所取得的售樓說明書屬最新版本。根據條例，提供予公眾的售樓說明書必須是在之前的三個月之內印製或檢視、或檢視及修改。
- 閱覽售樓說明書，並須特別留意以下資訊：
 - 售樓說明書內有否關於「有關資料」的部分，列出賣方知悉但並非為一般公眾人士所知悉，關於相當可能對享用有關住宅物業造成重大影響的事宜的資料。請注意，已在土地註冊處註冊的文件，其內容不會被視為「有關資料」；
 - 橫截面圖會顯示有關建築物相對毗連該建築物的每條街道的橫截面，以及每條上述街道與已知基準面和該建築物最低的一層住宅樓層的水平相對的水平。橫截面圖能以圖解形式，顯示出建築物最低一層住宅樓層和街道水平的高低差距，不論該最低住宅樓層以何種方式命名；
 - 室內和外部的裝置、裝修物料和設備；
 - 管理費按甚麼基準分擔；
 - 小業主有否責任或需要分擔管理、營運或維持有關發展項目以內或以外的公眾休憩用地或公共設施的開支，以及有關公眾休憩用地或公共設施的位置；以及
 - 小業主是否須要負責維修斜坡。

6. 政府批地文件和公契

- 閱覽政府批地文件和公契(或公契擬稿)。公契內載有天台和外牆業權等相關資料。賣方會在售樓處提供政府批地文件和公契(或公契擬稿)的複本，供準買家免費閱覽。
- 留意政府批地文件內所訂明小業主是否須要負責支付地稅。
- 留意公契內訂明有關物業內可否飼養動物。

7. 售樓處內有關可供揀選住宅物業的資料

- 向賣方查詢清楚有哪些一手住宅物業可供揀選。若賣方在售樓處內展示「消耗表」，您可從該「消耗表」得悉在每個銷售日的銷售進度資料，包括在該個銷售日開始時有哪些住宅物業可供出售，以及在該個銷售日內有哪些住宅物業已獲揀選及售出。
- 切勿隨便相信有關發展項目銷情的傳言，倉卒簽立臨時買賣合約。

8. 成交紀錄冊

- 留意發展項目的成交紀錄冊。賣方須於臨時買賣合約訂立後的24小時內，於紀錄冊披露該臨時買賣合約的資料，以及於買賣合約訂立後一個工作天內，披露該買賣合約的資料。您可透過成交紀錄冊得悉發展項目的銷售情況。
- 切勿將賣方接獲用作登記的購樓意向書或本票的數目視為銷情指標。發展項目的成交紀錄冊才是讓公眾掌握發展項目每日銷售情況的最可靠資料來源。

9. 買賣合約

- 確保臨時買賣合約和買賣合約包含條例所規定的強制性條文。
- 留意有關物業買賣交易所包括的裝置、裝修物料和設備，須在臨時買賣合約和買賣合約上列明。
- 留意夾附於買賣合約的圖則。該圖則會顯示所有賣方售予您的物業面積，而該面積通常較該物業的實用面積為大。
- 訂立臨時買賣合約時，您須向擁有人(即賣方)支付樓價**5%**的臨時訂金。
- 如您在訂立臨時買賣合約後**五個工作日**(工作日指並非公眾假日、星期六、黑色暴雨警告日或烈風警告日的日子)之內，沒有簽立買賣合約，該臨時買賣合約即告終止，有關臨時訂金(即樓價的5%)會被沒收，而擁有人(即賣方)不得因您沒有簽立買賣合約而對您提出進一步申索。
- 在訂立臨時買賣合約後的五個工作日之內，倘您簽立買賣合約，則擁有人(即賣方)必須在訂立該臨時買賣合約後的八個工作日之內簽立買賣合約。
- 有關的訂金，應付予負責為所涉物業擔任保證金保存人的律師事務所。

10. 表達購樓意向

- 留意在賣方(包括其獲授權代表)就有關住宅物業向公眾提供價單前，賣方不得尋求或接納任何對有關住宅物業的購樓意向(不論是否屬明確選擇購樓意向)。因此您不應向賣方或其授權代表提出有關意向。
- 留意在有關住宅物業的銷售開始前，賣方(包括其獲授權代表)不得尋求或接納任何對該物業的有明確選擇購樓意向。因此您不應向賣方或其授權代表提出有關意向。

Notes to purchasers of first-hand residential properties

一手住宅物業買家須知

11. 委託地產代理

- 留意倘賣方委任一個或多於一個地產代理，以協助銷售其發展項目內任何指明住宅物業，該發展項目的價單必須列明在價單印刷日期當日所有獲委任為地產代理的姓名/名稱。
- 您可委託任何地產代理(不一定是賣方所指定的地產代理)，以協助您購置發展項目內任何指明住宅物業；您亦可不委託任何地產代理。
- 委託地產代理以物色物業前，您應該 —
 - 了解該地產代理是否只代表您行事。該地產代理若同時代表賣方行事，倘發生利益衝突，未必能夠保障您的最大利益；
 - 了解您須否支付佣金予該地產代理。若須支付，有關的佣金金額和支付日期為何；以及
 - 留意只有持牌地產代理或營業員才可以接受您的委託。如有疑問，應要求該地產代理或營業員出示其「地產代理證」，或瀏覽地產代理監管局的網頁(網址：www.eaa.org.hk)，查閱牌照目錄。

12. 委聘律師

- 考慮自行委聘律師，以保障您的利益。該律師若同時代表賣方行事，倘發生利益衝突，未必能夠保障您的最大利益。
- 比較不同律師的收費。

適用於一手未落成住宅物業

13. 預售樓花同意書

- 洽購地政總署「預售樓花同意方案」下的未落成住宅物業時，應向賣方確認地政總署是否已就該發展項目批出「預售樓花同意書」。

14. 示範單位

- 賣方不一定須設置示範單位供準買家或公眾參觀，但賣方如為某指明住宅物業設置示範單位，必須首先設置該住宅物業的無改動示範單位，才可設置該住宅物業的經改動示範單位，並可以就該住宅物業設置多於一個經改動示範單位。
- 參觀示範單位時，務必視察無改動示範單位，以便與經改動示範單位作出比較。然而，條例並沒有限制賣方安排參觀無改動示範單位及經改動示範單位的先後次序。
- 賣方設置示範單位供公眾參觀時，應已提供有關發展項目的售樓說明書。因此，緊記先行索取售樓說明書，以便在參觀示範單位時參閱相關資料。
- 您可以在無改動示範單位及經改動示範單位中進行量度，並在無改動示範單位內拍照或拍攝影片，惟在確保示範單位參觀者人身安全的前提下，賣方可能會設定合理的限制。

適用於一手未落成住宅物業及尚待符合條件的已落成住宅物業

15. 預計關鍵日期及收樓日期

- 查閱售樓說明書中有關發展項目的預計關鍵日期³。
 - 售樓說明書中有關發展項目的預計關鍵日期並不同買家的「收樓日期」。買家的「收樓日期」必定較發展項目的預計關鍵日期遲。
- 收樓日期
 - 條例規定買賣合約須載有強制性條文，列明賣方須於買賣合約內列出的預計關鍵日期後的14日內，以書面為發展項目申請佔用文件、合格證明書，或地政總署署長的轉讓同意(視屬何種情況而定)。
 - 如發展項目屬地政總署預售樓花同意方案所規管，賣方須在合格證明書或地政總署署長的轉讓同意發出後的一個月內(以較早者為準)，就賣方有能力有效地轉讓有關物業一事，以書面通知買家；或
 - 如發展項目並非屬地政總署預售樓花同意方案所規管，賣方須在佔用文件(包括佔用許可證)發出後的六個月內，就賣方有能力有效地轉讓有關物業一事，以書面通知買家。
 - 條例規定買賣合約須載有強制性條文，列明有關物業的買賣須於賣方發出上述通知的日期的14日內完成。有關物業的買賣完成後，賣方將安排買家收樓事宜。

³ 一般而言，「關鍵日期」指該項目符合批地文件的條件的日期，或該項目在遵照經批准的建築圖則的情況下或按照豁免證明書的發出的條件在各方面均屬完成的日期。有關詳情請參閱條例第2條。

Notes to purchasers of first-hand residential properties

一手住宅物業買家須知

- 認可人士可批予在預計關鍵日期之後完成發展項目
 - 條例規定買賣合約須載有強制性條文，列明發展項目的認可人士可以在顧及純粹由以下一個或多於一個原因所導致的延遲後，批予在預計關鍵日期之後，完成發展項目：
 - 工人罷工或封閉工地；
 - 暴動或內亂；
 - 不可抗力或天災；
 - 火警或其他賣方所不能控制的意外；
 - 戰爭；或
 - 惡劣天氣。
 - 發展項目的認可人士可以按情況，多於一次批予延後預計關鍵日期以完成發展項目，即收樓日期可能延遲。
 - 條例規定買賣合約須載有強制性條文，列明賣方須於認可人士批予延期後的14日內，向買家提供有關延期證明書的文本。
- 如對收樓日期有任何疑問，可向賣方查詢。

適用於一手已落成住宅物業

16. 賣方資料表格

- 確保取得最近三個月內印製有關您擬購買的一手已落成住宅物業的「賣方資料表格」。

17. 參觀物業

- 購置住宅物業前，確保已獲安排參觀您打算購置的住宅物業。倘參觀有關物業並非合理地切實可行，則應參觀與有關物業相若的物業，除非您以書面同意賣方無須開放與有關物業相若的物業供您參觀。您應仔細考慮，然後才決定是否簽署豁免上述規定的書面同意。
- 除非有關物業根據租約持有，或為確保物業參觀者的人身安全而須設定合理限制，您可以對該物業進行量度、拍照或拍攝影片。

任何與賣方銷售受條例所規管的一手住宅物業有關的投訴和查詢，請與一手住宅物業銷售監管局聯絡。

網 址：www.srpa.gov.hk
電 話：2817 3313
電 郵：enquiry_srpa@hd.gov.hk
傳 真：2219 2220

其他相關聯絡資料：

消費者委員會

網 址：www.consumer.org.hk
電 話：2929 2222
電 郵：cc@consumer.org.hk
傳 真：2856 3611

地產代理監管局

網 址：www.eaa.org.hk
電 話：2111 2777
電 郵：enquiry@eaa.org.hk
傳 真：2598 9596

香港地產建設商會

電 話：2826 0111
傳 真：2845 2521

運輸及房屋局
一手住宅物業銷售監管局
2017年8月

Information on the phase

期數的資料

Name of the Phase

THE PAVILIA FARM II

Name of the street at which the Phase is situated

Che Kung Miu Road

Street number allocated by the Commissioner of Rating and Valuation for the purpose of distinguishing the Phase (provisional)

No. 18

Remark: The above provisional street number is subject to confirmation when the Phase is completed.

The Phase consists of 3 multi-unit buildings

Total number of storeys of each multi-unit building

Tower 5 (5A & 5B): 57 storeys (excluding B4/F - B1/F, the roof, upper roof and top roof)

Tower 6 (6A & 6B): 57 storeys (excluding B4/F - B1/F, the roof, upper roof and top roof)

Tower 7 (7A & 7B): 57 storeys (excluding B4/F - B1/F, the roof, upper roof and top roof)

Floor numbering in each multi-unit building as provided in the approved building plans for the Phase

Tower 5 (5A & 5B): B4/F - B1/F, G/F, 1/F - 12/F, 15/F - 23/F, 25/F - 33/F, 35/F - 43/F, 45/F - 53/F and 55/F - 62/F

Tower 6 (6A & 6B): B4/F - B1/F, G/F, 1/F - 12/F, 15/F - 23/F, 25/F - 33/F, 35/F - 43/F, 45/F - 53/F and 55/F - 62/F

Tower 7 (7A & 7B): B4/F - B1/F, G/F, 1/F - 12/F, 15/F - 23/F, 25/F - 33/F, 35/F - 43/F, 45/F - 53/F and 55/F - 62/F

Omitted floor numbers in each multi-unit building in which the floor numbering is not in consecutive order

Tower 5 (5A & 5B): 13/F, 14/F, 24/F, 34/F, 44/F and 54/F

Tower 6 (6A & 6B): 13/F, 14/F, 24/F, 34/F, 44/F and 54/F

Tower 7 (7A & 7B): 13/F, 14/F, 24/F, 34/F, 44/F and 54/F

Refuge floors of each multi-unit building

Tower 5 (5A & 5B): 17/F and 40/F

Tower 6 (6A & 6B): 17/F and 40/F

Tower 7 (7A & 7B): 17/F and 40/F

The Phase is an uncompleted phase

- The estimated material date for the Phase as provided by the authorized person for the Phase is 30 November 2022 .
- The estimated material date is subject to any extension of time that is permitted under the agreement for sale and purchase.
- Under the land grant, the consent of the Director of Lands is required to be given for the sale and purchase. For the purpose of the agreement for sale and purchase, without limiting any other means by which the completion of the Phase may be proved, the issue of a certificate of compliance or consent to assign by the Director of Lands is conclusive evidence that the Phase has been completed or is deemed to be completed (as the case may be).

期數名稱

柏傲莊 II

期數所位於的街道的名稱

車公廟路

由差餉物業估價署署長為識別期數的目的而編配的門牌號數(臨時)

18號

備註：上述臨時門牌號數有待期數建成時確認。

期數包含3幢多單位建築物

每幢多單位建築物的樓層的總數

第5座 (5A及5B)：57層 (不包括地庫4樓至地庫1樓、天台、上層天台及頂層天台)

第6座 (6A及6B)：57層 (不包括地庫4樓至地庫1樓、天台、上層天台及頂層天台)

第7座 (7A及7B)：57層 (不包括地庫4樓至地庫1樓、天台、上層天台及頂層天台)

期數的經批准的建築圖則所規定的每幢多單位建築物內的樓層號數

第5座 (5A及5B)：地庫4樓至地庫1樓、地下、1樓至12樓、15樓至23樓、25樓至33樓、35樓至43樓、45樓至53樓及55樓至62樓

第6座 (6A及6B)：地庫4樓至地庫1樓、地下、1樓至12樓、15樓至23樓、25樓至33樓、35樓至43樓、45樓至53樓及55樓至62樓

第7座 (7A及7B)：地庫4樓至地庫1樓、地下、1樓至12樓、15樓至23樓、25樓至33樓、35樓至43樓、45樓至53樓及55樓至62樓

每幢有不依連續次序的樓層號數的多單位建築物內被略去的樓層號數

第5座 (5A及5B)：13樓、14樓、24樓、34樓、44樓及54樓

第6座 (6A及6B)：13樓、14樓、24樓、34樓、44樓及54樓

第7座 (7A及7B)：13樓、14樓、24樓、34樓、44樓及54樓

每幢多單位建築物內的庇護層

第5座 (5A及5B)：17樓及40樓

第6座 (6A及6B)：17樓及40樓

第7座 (7A及7B)：17樓及40樓

本期數屬未落成期數

- 由期數的認可人士提供該期數的預計關鍵日期為2022年11月30日。
- 預計關鍵日期是受到買賣合約所允許的任何延期所規限的。
- 根據批地文件，進行該項買賣，需獲地政總署署長同意。為買賣合約的目的，在不局限任何其他可用以證明期數落成的方法的原則下，地政總署署長發出的合格證明書或轉讓同意，即為期數已落成或當作已落成(視屬何情況而定)的確認。

Information on vendor and others involved in the phase

賣方及有參與期數的其他人的資料

Vendor

MTR Corporation Limited (as "Owner")

Lucrative Venture Limited (as "Person so engaged")

(Note: "Owner" means the legal or beneficial owner of the residential properties in the Phase, and "Person so engaged" means the person who is engaged by the owner to co-ordinate and supervise the process of designing, planning, constructing, fitting out, completing and marketing the Phase.

Holding company of the Vendor

Holding company of the Owner (MTR Corporation Limited)

Not Applicable

Holding company of the Person so engaged (Lucrative Venture Limited)

New World Development Company Limited

The authorized person for the Phase and the firm or corporation of which the authorized person is a proprietor, director or employee in his or her professional capacity

Mr. Leung Kit-Man Andy of Ronald Lu & Partners (Hong Kong) Limited

Building contractor for the Phase

Hip Seng Construction Company Limited

The firms of solicitors acting for the Owner in relation to the sale of residential properties in the Phase

Deacons

Mayer Brown

Kao, Lee & Yip

Any authorized institution that has made a loan, or has undertaken to provide finance, for the construction of the Phase

Not Applicable

Any other person who has made a loan for the construction of the Phase

New World Finance Company Limited

賣方

香港鐵路有限公司 (作為“擁有人”)

珽基有限公司 (作為“如此聘用的人”)

(備註：“擁有人”指期數中的住宅物業的法律上的擁有人或實益擁有人，“如此聘用的人”指擁有人聘用以統籌和監管期數的設計、規劃、建造、裝置、完成及銷售過程的人士。)

賣方的控權公司

擁有人 (香港鐵路有限公司) 的控權公司

不適用

如此聘用的人 (珽基有限公司) 的控權公司

新世界發展有限公司

期數的認可人士及該認可人士以其專業身份擔任經營人、董事或僱員的商號或法團

呂元祥建築師事務所(香港)有限公司之梁傑文先生

期數的承建商

協盛建築有限公司

就期數中的住宅物業的出售而代表擁有人行事的律師事務所

的近律師行

孖士打律師行

高李葉律師行

已為期數的建造提供貸款或已承諾為該項建造提供融資的認可機構

不適用

已為期數的建造提供貸款的任何其他人

新世界金融有限公司

Relationship between parties involved in the phase 有參與期數的各方的關係

(a)	The vendor [#] or a building contractor for the Phase is an individual, and that vendor [#] or contractor is an immediate family member of an authorized person for the Phase 賣方 [#] 或有關期數的承建商屬個人，並屬該期數的認可人士的家人	Not Applicable 不適用
(b)	The vendor [#] or a building contractor for the Phase is a partnership, and a partner of that vendor [#] or contractor is an immediate family member of such an authorized person 賣方 [#] 或該期數的承建商屬合夥，而該賣方 [#] 或承建商的合夥人屬上述認可人士的家人	Not Applicable 不適用
(c)	The vendor [#] or a building contractor for the Phase is a corporation, and a director or the secretary of that vendor [#] or contractor (or a holding company of that vendor [#]) is an immediate family member of such an authorized person 賣方 [#] 或該期數的承建商屬法團，而該賣方 [#] 或承建商(或該賣方 [#] 的控權公司)的董事或秘書屬上述認可人士的家人	No 否
(d)	The vendor [#] or a building contractor for the Phase is an individual, and that vendor [#] or contractor is an immediate family member of an associate of such an authorized person 賣方 [#] 或該期數的承建商屬個人，並屬上述認可人士的有聯繫人士的家人	Not Applicable 不適用
(e)	The vendor [#] or a building contractor for the Phase is a partnership, and a partner of that vendor [#] or contractor is an immediate family member of an associate of such an authorized person 賣方 [#] 或該期數的承建商屬合夥，而該賣方 [#] 或承建商的合夥人屬上述認可人士的有聯繫人士的家人	Not Applicable 不適用
(f)	The vendor [#] or a building contractor for the Phase is a corporation, and a director or the secretary of that vendor [#] or contractor (or a holding company of that vendor [#]) is an immediate family member of an associate of such an authorized person 賣方 [#] 或該期數的承建商屬法團，而該賣方 [#] 或承建商(或該賣方 [#] 的控權公司)的董事或秘書屬上述認可人士的有聯繫人士的家人	No 否
(g)	The vendor [#] or a building contractor for the Phase is an individual, and that vendor [#] or contractor is an immediate family member of a proprietor of a firm of solicitors acting for the owner in relation to the sale of residential properties in the Phase 賣方 [#] 或該期數的承建商屬個人，並屬就該期數內的住宅物業的出售代表擁有人行事的律師事務所行事的經營人的家人	Not Applicable 不適用
(h)	The vendor [#] or a building contractor for the Phase is a partnership, and a partner of that vendor [#] or contractor is an immediate family member of a proprietor of a firm of solicitors acting for the owner in relation to the sale of residential properties in the Phase 賣方 [#] 或該期數的承建商屬合夥，而該賣方 [#] 或承建商的合夥人屬就該期數內的住宅物業的出售代表擁有人行事的律師事務所行事的經營人的家人	Not Applicable 不適用
(i)	The vendor [#] or a building contractor for the Phase is a corporation, and a director or the secretary of that vendor [#] or contractor (or a holding company of that vendor [#]) is an immediate family member of a proprietor of such a firm of solicitors 賣方 [#] 或該期數的承建商屬法團，而該賣方 [#] 或承建商(或該賣方 [#] 的控權公司)的董事或秘書屬上述律師事務所的經營人的家人	No 否

Remarks:

[#] A reference to vendor is a reference to either MTR Corporation Limited (as Owner) or Lucrative Venture Limited (as Person so engaged).

備註：

[#] 在此提述賣方即提述香港鐵路有限公司(作為擁有人)或珽基有限公司(作為如此聘用的人)。

Relationship between parties involved in the phase 有參與期數的各方的關係

(j)	The vendor [#] , a holding company of the vendor [#] , or a building contractor for the Phase, is a private company, and an authorized person for the Phase, or an associate of such an authorized person, holds at least 10% of the issued shares in that vendor [#] , holding company or contractor 賣方 [#] 、賣方 [#] 的控股公司或有關期數的承建商屬私人公司，而該期數的認可人士或該認可人士的有聯繫人士持有該賣方 [#] 、控股公司或承建商最少10%的已發行股份	No 否
(k)	The vendor [#] , a holding company of the vendor [#] , or a building contractor for the Phase, is a listed company, and such an authorized person, or such an associate, holds at least 1% of the issued shares in that vendor [#] , holding company or contractor 賣方 [#] 、賣方 [#] 的控股公司或該期數的承建商屬上市公司，而上述認可人士或上述有聯繫人士持有該賣方 [#] 、控股公司或承建商最少1%的已發行股份	No 否
(l)	The vendor [#] or a building contractor for the Phase is a corporation, and such an authorized person, or such an associate, is an employee, director or secretary of that vendor [#] or contractor or of a holding company of that vendor [#] 賣方 [#] 或該期數的承建商屬法團，而上述認可人士或上述有聯繫人士屬該賣方 [#] 、承建商或該賣方 [#] 的控股公司的僱員、董事或秘書	No 否
(m)	The vendor [#] or a building contractor for the Phase is a partnership, and such an authorized person, or such an associate, is an employee of that vendor [#] or contractor 賣方 [#] 或該期數的承建商屬合夥，而上述認可人士或上述有聯繫人士屬該賣方 [#] 或承建商的僱員	Not Applicable 不適用
(n)	The vendor [#] , a holding company of the vendor [#] , or a building contractor for the Phase, is a private company, and a proprietor of a firm of solicitors acting for the owner in relation to the sale of residential properties in the Phase holds at least 10% of the issued shares in that vendor [#] , holding company or contractor 賣方 [#] 、賣方 [#] 的控股公司或該期數的承建商屬私人公司，而就該期數中的住宅物業的出售而代表擁有人行事的律師事務所的經營人持有該賣方 [#] 、控股公司或承建商最少10%的已發行股份	No 否
(o)	The vendor [#] , a holding company of the vendor [#] , or a building contractor for the Phase, is a listed company, and a proprietor of such a firm of solicitors holds at least 1% of the issued shares in that vendor [#] , holding company or contractor 賣方 [#] 、賣方 [#] 的控股公司或該期數的承建商屬上市公司，而上述律師事務所的經營人持有該賣方 [#] 、控股公司或承建商最少1%的已發行股份	No 否
(p)	The vendor [#] or a building contractor for the Phase is a corporation, and a proprietor of such a firm of solicitors is an employee, director or secretary of that vendor [#] or contractor or of a holding company of that vendor [#] 賣方 [#] 或該期數的承建商屬法團，而上述律師事務所的經營人屬該賣方 [#] 或承建商或該賣方 [#] 的控股公司的僱員、董事或秘書	No 否
(q)	The vendor [#] or a building contractor for the Phase is a partnership, and a proprietor of such a firm of solicitors is an employee of that vendor [#] or contractor 賣方 [#] 或該期數的承建商屬合夥，而上述律師事務所的經營人屬該賣方 [#] 或承建商的僱員	Not Applicable 不適用
(r)	The vendor [#] or a building contractor for the Phase is a corporation, and the corporation of which an authorized person for the Phase is a director or employee in his or her professional capacity is an associate corporation of that vendor [#] or contractor or of a holding company of that vendor [#] 賣方 [#] 或該期數的承建商屬法團，而該期數的認可人士以其專業身份擔任董事或僱員的法團為該賣方 [#] 或承建商或該賣方 [#] 的控股公司的有聯繫法團	No 否
(s)	The vendor [#] or a building contractor for the Phase is a corporation, and that contractor is an associate corporation of that vendor [#] or of a holding company of that vendor [#] 賣方 [#] 或該期數的承建商屬法團，而該承建商屬該賣方 [#] 或該賣方 [#] 的控股公司的有聯繫法團	Yes* 是*

Remarks:

[#] A reference to vendor is a reference to either MTR Corporation Limited (as Owner) or Lucrative Venture Limited (as Person so engaged).

* The building contractor for the Phase, Hip Seng Construction Company Limited, is an associate corporation of Lucrative Venture Limited (Person so engaged) and also an associate corporation of the holding company of Lucrative Venture Limited (Person so engaged).

備註：

[#] 在此提述賣方即提述香港鐵路有限公司(作為擁有人)或珽基有限公司(作為如此聘用的人)。

* 期數的承建商協盛建築有限公司屬於珽基有限公司(如此聘用的人)的有聯繫法團及珽基有限公司(如此聘用的人)之控股公司的有聯繫法團。

Information on design of the phase 期數的設計的資料

There will be non-structural prefabricated external walls forming part of the enclosing walls of the Phase.

The thickness of the non-structural prefabricated external walls of each block is 150mm.

Total Area of the Non-Structural Prefabricated External Walls of each Residential Property 每個住宅物業的非結構的預製外牆的總面積			
Description of Residential Property 物業的描述			Total Area 總面積
Tower Name 座號	Floor 樓層	Flat 單位	sq.m 平方米
Tower 5 (5A) 第5座 (5A)	7/F-12/F, 15/F-16/F, 18/F-23/F, 25/F-33/F, 35/F-39/F, 41/F-43/F, 45/F-53/F & 55/F-61/F 7樓至12樓、15樓至16樓、 18樓至23樓、25樓至33樓、 35樓至39樓、41樓至43樓、 45樓至53樓及55樓至61樓	A	0.172
		B	0.188
		C	-
		D	0.225
		E	0.304
	62/F 62樓	A	0.172
		B	0.188
		D	0.225
		E	0.304
Tower 5 (5B) 第5座 (5B)	7/F-12/F, 15/F-16/F, 18/F-23/F, 25/F-33/F, 35/F-39/F, 41/F-43/F, 45/F-53/F & 55/F-61/F 7樓至12樓、15樓至16樓、 18樓至23樓、25樓至33樓、 35樓至39樓、41樓至43樓、 45樓至53樓及55樓至61樓	A	0.180
		B	0.844
		C	0.419
		D	0.450
	62/F 62樓	A	0.360
		C	0.419
		D	0.450

Remarks :

- 13/F, 14/F, 24/F, 34/F, 44/F and 54/F of Tower 5 (5A & 5B) are omitted.
- 13/F, 14/F, 24/F, 34/F, 44/F and 54/F of Tower 6 (6A & 6B) are omitted.

期數將會有非結構的預製外牆構成圍封牆的一部份。

每幢建築物的非結構的預製外牆之厚度為150毫米。

Total Area of the Non-Structural Prefabricated External Walls of each Residential Property 每個住宅物業的非結構的預製外牆的總面積			
Description of Residential Property 物業的描述			Total Area 總面積
Tower Name 座號	Floor 樓層	Flat 單位	sq.m 平方米
Tower 6 (6A) 第6座 (6A)	7/F-12/F, 15/F-16/F, 18/F-23/F, 25/F-33/F, 35/F-39/F, 41/F-43/F, 45/F-53/F & 55/F-61/F 7樓至12樓、15樓至16樓、 18樓至23樓、25樓至33樓、 35樓至39樓、41樓至43樓、 45樓至53樓及55樓至61樓	A	0.180
		B	0.180
		C	-
		D	-
		E	-
	62/F 62樓	A	0.360
		C	-
		D	-
		E	-
Tower 6 (6B) 第6座 (6B)	7/F-12/F, 15/F-16/F, 18/F-23/F, 25/F-33/F & 35/F-39/F 7樓至12樓、15樓至16樓、 18樓至23樓、25樓至33樓及 35樓至39樓	A	0.390
		C	0.248
		D	-
		E	-
		F	-
	41/F-43/F, 45/F-53/F & 55/F-62/F 41樓至43樓、45樓至53樓及 55樓至62樓	A	0.390
		C	0.248
		E	-
		F	-

備註：

- 第5座 (5A及5B)不設13樓、14樓、24樓、34樓、44樓及54樓。
- 第6座 (6A及6B)不設13樓、14樓、24樓、34樓、44樓及54樓。

Information on design of the phase 期數的設計的資料

There will be non-structural prefabricated external walls forming part of the enclosing walls of the Phase.

The thickness of the non-structural prefabricated external walls of each block is 150mm.

期數將會有非結構的預製外牆構成圍封牆的一部份。

每幢建築物的非結構的預製外牆之厚度為150毫米。

Total Area of the Non-Structural Prefabricated External Walls of each Residential Property 每個住宅物業的非結構的預製外牆的總面積			
Description of Residential Property 物業的描述			Total Area 總面積
Tower Name 座號	Floor 樓層	Flat 單位	sq.m 平方米
Tower 7 (7A) 第7座 (7A)	7/F-12/F, 15/F-16/F, 18/F-23/F, 25/F-33/F, 35/F-39/F, 41/F-43/F, 45/F-53/F & 55/F-61/F 7樓至12樓、15樓至16樓、 18樓至23樓、25樓至33樓、 35樓至39樓、41樓至43樓、 45樓至53樓及55樓至61樓	A	0.180
		B	0.180
		C	-
		D	-
		E	-
		F	-
	62/F 62樓	A	0.360
		C	-
		D	-
		E	-
Tower 7 (7B) 第7座 (7B)	7/F-12/F, 15/F-16/F, 18/F-23/F, 25/F-33/F, 35/F-39/F, 41/F-43/F, 45/F-53/F & 55/F-61/F 7樓至12樓、15樓至16樓、 18樓至23樓、25樓至33樓、 35樓至39樓、41樓至43樓、 45樓至53樓及55樓至61樓	A	0.180
		B	0.180
		C	-
		D	-
		E	-
	62/F 62樓	A	0.180
		B	0.180
		C	-
		D	-

Remark :

- 13/F, 14/F, 24/F, 34/F, 44/F and 54/F of Tower 7 (7A & 7B) are omitted.

備註：

- 第7座 (7A及7B)不設13樓、14樓、24樓、34樓、44樓及54樓。

Information on design of the phase 期數的設計的資料

There will be curtain walls forming part of the enclosing walls of the Phase.

The thickness of the curtain walls of each building is 200mm.

Total Area of the Curtain Walls of each Residential Property 每個住宅物業的幕牆的總面積			
Description of Residential Property 物業的描述			Total Area 總面積
Tower Name 座號	Floor 樓層	Flat 單位	sq.m 平方米
Tower 5 (5A) 第5座 (5A)	7/F-12/F, 15/F-16/F, 18/F-23/F, 25/F-33/F, 35/F-39/F, 41/F-43/F, 45/F-53/F & 55/F-61/F 7樓至12樓、15樓至16樓、 18樓至23樓、25樓至33樓、 35樓至39樓、41樓至43樓、 45樓至53樓及55樓至61樓	A	1.409
		B	0.719
		C	0.907
		D	0.840
		E	0.801
	62/F 62樓	A	3.124
		B	0.719
		D	0.840
		E	0.801
Tower 5 (5B) 第5座 (5B)	7/F-12/F, 15/F-16/F, 18/F-23/F, 25/F-33/F, 35/F-39/F, 41/F-43/F, 45/F-53/F & 55/F-61/F 7樓至12樓、15樓至16樓、 18樓至23樓、25樓至33樓、 35樓至39樓、41樓至43樓、 45樓至53樓及55樓至61樓	A	1.158
		B	1.401
		C	0.780
		D	0.658
	62/F 62樓	A	3.294
		C	0.780
		D	0.658

Remarks :

- 13/F, 14/F, 24/F, 34/F, 44/F and 54/F of Tower 5 (5A & 5B) are omitted.
- 13/F, 14/F, 24/F, 34/F, 44/F and 54/F of Tower 6 (6A & 6B) are omitted.

期數將會有幕牆構成圍封牆的一部份。

每幢建築物的幕牆之厚度為200毫米。

Total Area of the Curtain Walls of each Residential Property 每個住宅物業的幕牆的總面積			
Description of Residential Property 物業的描述			Total Area 總面積
Tower Name 座號	Floor 樓層	Flat 單位	sq.m 平方米
Tower 6 (6A) 第6座 (6A)	7/F-12/F, 15/F-16/F, 18/F-23/F, 25/F-33/F, 35/F-39/F, 41/F-43/F, 45/F-53/F & 55/F-61/F 7樓至12樓、15樓至16樓、 18樓至23樓、25樓至33樓、 35樓至39樓、41樓至43樓、 45樓至53樓及55樓至61樓	A	1.402
		B	0.728
		C	0.647
		D	0.691
		E	0.705
	62/F 62樓	A	3.091
		C	0.647
		D	0.691
		E	0.705
Tower 6 (6B) 第6座 (6B)	7/F-12/F, 15/F-16/F, 18/F-23/F, 25/F-33/F & 35/F-39/F 7樓至12樓、15樓至16樓、 18樓至23樓、25樓至33樓及 35樓至39樓	A	1.415
		C	0.696
		D	0.262
		E	0.555
		F	0.641
	41/F-43/F, 45/F-53/F & 55/F-62/F 41樓至43樓、45樓至53樓及 55樓至62樓	A	1.415
		C	1.372
		E	0.555
		F	0.641

備註：

- 第5座 (5A及5B)不設13樓、14樓、24樓、34樓、44樓及54樓。
- 第6座 (6A及6B)不設13樓、14樓、24樓、34樓、44樓及54樓。

Information on design of the phase 期數的設計的資料

There will be curtain walls forming part of the enclosing walls of the Phase.

The thickness of the curtain walls of each building is 200mm.

期數將會有幕牆構成圍封牆的一部份。

每幢建築物的幕牆之厚度為200毫米。

Total Area of the Curtain Walls of each Residential Property 每個住宅物業的幕牆的總面積			
Description of Residential Property 物業的描述			Total Area 總面積
Tower Name 座號	Floor 樓層	Flat 單位	sq.m 平方米
Tower 7 (7A) 第7座 (7A)	7/F-12/F, 15/F-16/F, 18/F-23/F, 25/F-33/F, 35/F-39/F, 41/F-43/F, 45/F-53/F & 55/F-61/F 7樓至12樓、15樓至16樓、 18樓至23樓、25樓至33樓、 35樓至39樓、41樓至43樓、 45樓至53樓及55樓至61樓	A	1.457
		B	1.258
		C	0.733
		D	0.548
		E	0.246
		F	0.727
	62/F 62樓	A	3.531
		C	0.733
		D	0.548
		E	0.246
Tower 7 (7B) 第7座 (7B)	7/F-12/F, 15/F-16/F, 18/F-23/F, 25/F-33/F, 35/F-39/F, 41/F-43/F, 45/F-53/F & 55/F-61/F 7樓至12樓、15樓至16樓、 18樓至23樓、25樓至33樓、 35樓至39樓、41樓至43樓、 45樓至53樓及55樓至61樓	A	1.708
		B	0.749
		C	0.531
		D	1.188
		E	0.731
	62/F 62樓	A	1.708
		B	0.749
		C	0.531
		D	1.736

Remark :

- 13/F, 14/F, 24/F, 34/F, 44/F and 54/F of Tower 7 (7A & 7B) are omitted.

備註：

- 第7座 (7A及7B)不設13樓、14樓、24樓、34樓、44樓及54樓。

Information on property management 物業管理的資料

The latest draft of the Principal Deed of Mutual Covenant of the Development does not provide the name of the manager of the Phase, and the Vendor intends to appoint MTR Corporation Limited or its subsidiary as the manager of the Phase upon the signing of the Principal Deed of Mutual Covenant.

發展項目主公契的最新擬稿未有提供期數的管理人的名稱，而賣方擬在簽立主公契時委任香港鐵路有限公司或其子公司為期數的管理人。

Location plan of the development

發展項目的所在位置圖

The Location Plan is prepared based on a reproduction of Survey Sheet No. 7-SW-D dated 27 April 2020 with adjustments where necessary.

所在位置圖依據日期為2020年4月27日之測繪圖(編號7-SW-D)複印後擬備，有需要處經修正處理。

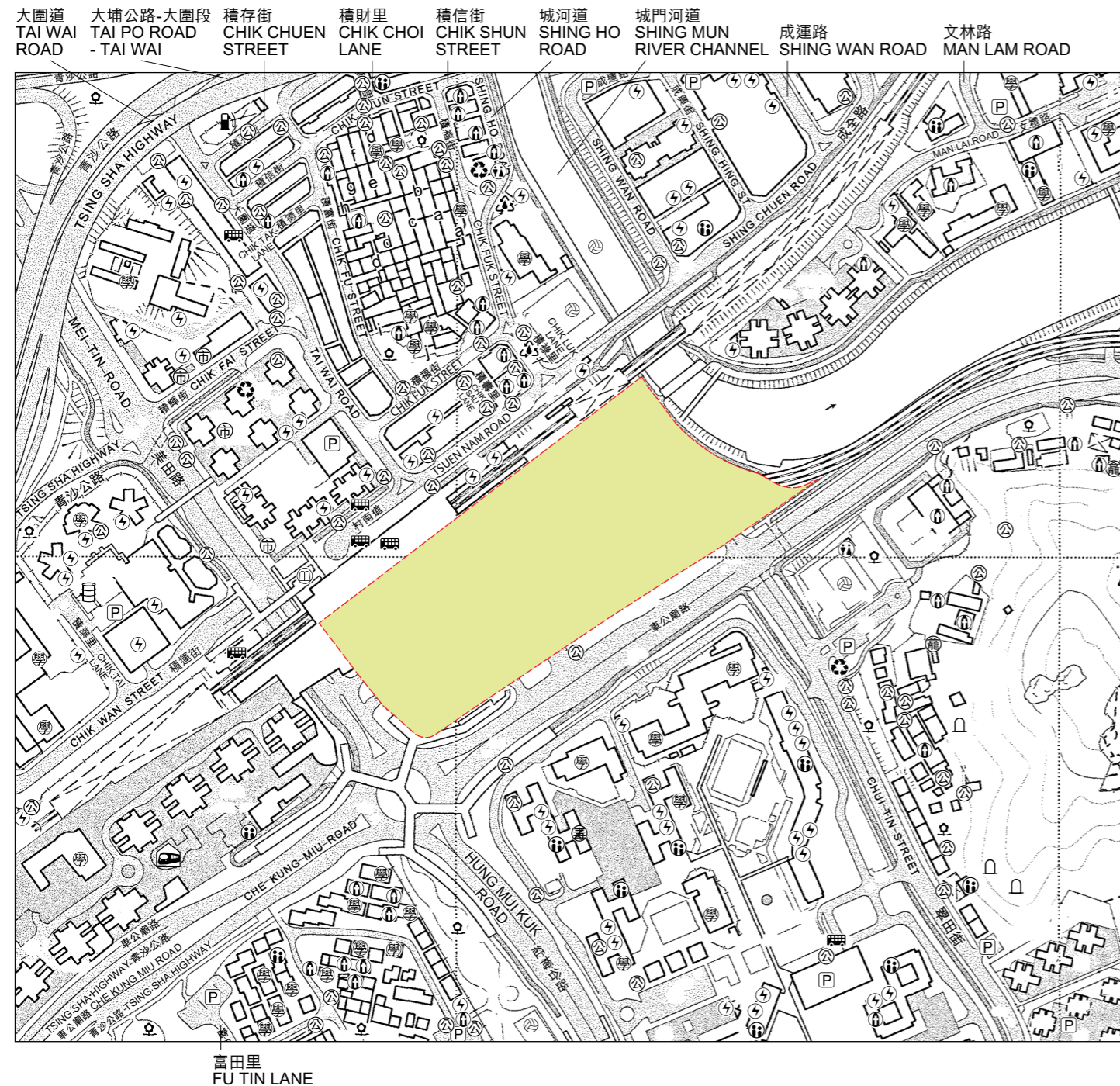

Location of the Development
發展項目的位置

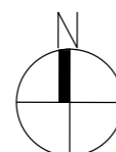

Legend 圖例

- Addiction treatment centre
戒毒院所
- Cemetery
墳場
- Columbarium
骨灰龕
- Oil depot
油庫
- Market (including a wet market and a wholesale market)
市場 (包括濕貨市場及批發市場)
- Refuse collection point
垃圾收集站
- Power plant (including electricity sub-stations)
發電廠 (包括電力分站)
- Public carpark (including a lorry park)
公眾停車場 (包括貨車停泊處)
- Public convenience
公廁
- Library
圖書館
- Public park
公園
- Public transport terminal (including a rail station)
公共交通總站 (包括鐵路車站)
- Public utility installation
公用事業設施裝置
- Religious institution (including a church, a temple and a Tsz Tong)
宗教場所 (包括教堂、廟宇及祠堂)
- School (including a kindergarten)
學校 (包括幼稚園)
- Sewage treatment works and facilities
污水處理廠及設施
- Social welfare facilities (including an elderly centre and a home for the mentally disabled)
社會福利設施 (包括老人中心及弱智人士護理院)
- Sports facilities (including a sports ground and a swimming pool)
體育設施 (包括運動場及游泳池)
- Railway depot
鐵路車廠
- Petrol filling station
油站

Street name(s) not shown in full in the Location Plan of the Development:

於發展項目的所在位置圖未能顯示之街道全名：

- | | | | |
|--------------------------|-------|---------------------------|-------|
| a: FIRST STREET TAI WAI | 大圍第一街 | f: SIXTH STREET TAI WAI | 大圍第六街 |
| b: SECOND STREET TAI WAI | 大圍第二街 | g: SEVENTH STREET TAI WAI | 大圍第七街 |
| c: THIRD STREET TAI WAI | 大圍第三街 | h: EIGHTH STREET TAI WAI | 大圍第八街 |
| d: FOURTH STREET TAI WAI | 大圍第四街 | i: NINTH STREET TAI WAI | 大圍第九街 |
| e: FIFTH STREET TAI WAI | 大圍第五街 | j: TENTH STREET TAI WAI | 大圍第十街 |

Remarks :

- Due to technical reasons as a result of the irregular boundary of the Development, the Location Plan has shown more than the area required under the Residential Properties (First-hand Sales) Ordinance.
- The map reproduced with permission of the Director of Lands. © The Government of the Hong Kong SAR. Licence No. 66/2020.
- The vendor advises prospective purchasers to conduct an on-site visit for a better understanding of the development site, its surrounding environment and the public facilities nearby.

備註：

- 因發展項目的不規則界線引致的技術原因，所在位置圖所顯示的範圍多於《一手住宅物業銷售條例》所要求。
- 地圖版權屬香港特別行政區政府，經地政總署准許複印，版權特許編號66/2020。
- 賣方建議準買方到有關發展地盤作實地考察，以對該發展地盤、其周邊地區環境及附近的公共設施有較佳了解。

Aerial photograph of the phase 期數的鳥瞰照片

Adopted from part of the aerial photograph taken by the Survey and Mapping Office of Lands Department at a flying height of 6,900 feet, photo No. E068081C, dated 1 October 2019.
摘錄自地政總署測繪處於2019年10月1日在6,900呎飛行高度拍攝之鳥瞰照片，編號為E068081C。



This blank area falls outside the coverage of the aerial photograph
鳥瞰照片並不覆蓋
本空白範圍

● Location of the Phase
期數的位置

Survey and Mapping Office, Lands Department, The Government of the HKSAR © Copyright reserved - reproduction by permission only.
香港特別行政區政府地政總署測繪處版權所有，未經許可，不得複製。

Adopted from part of the aerial photograph taken by the Survey and Mapping Office of Lands Department at a flying height of 6,900 feet, photo No. E068079C, dated 1 October 2019.
摘錄自地政總署測繪處於2019年10月1日在6,900呎飛行高度拍攝之鳥瞰照片，編號為E068079C。



This blank area falls outside the coverage of the aerial photograph
鳥瞰照片並不覆蓋
本空白範圍

Remarks :

1. The aerial photographs are available for free inspection during normal office hours at the sales office.
2. Due to technical reasons as a result of the irregular boundary of the Phase, the aerial photographs have shown more than the area required under the Residential Properties (First-hand Sales) Ordinance.

備註：

1. 該等鳥瞰照片存於售樓處，於正常辦公時間內供免費查閱。
2. 因期數的不規則界線引致的技術原因，鳥瞰照片所顯示的範圍多於《一手住宅物業銷售條例》所要求。

Outline zoning plan etc. relating to the development 關乎發展項目的分區計劃大綱圖等

Part of the approved Sha Tin Outline Zoning Plan with plan No. S/ST/34 gazetted on 8 June 2018, with adjustments where necessary as shown in red.
 摘錄自2018年6月8日憲報公布之沙田分區計劃大綱核准圖，圖則編號為S/ST/34，經修正處理之處以紅色表示。

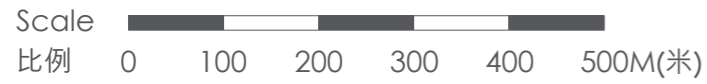
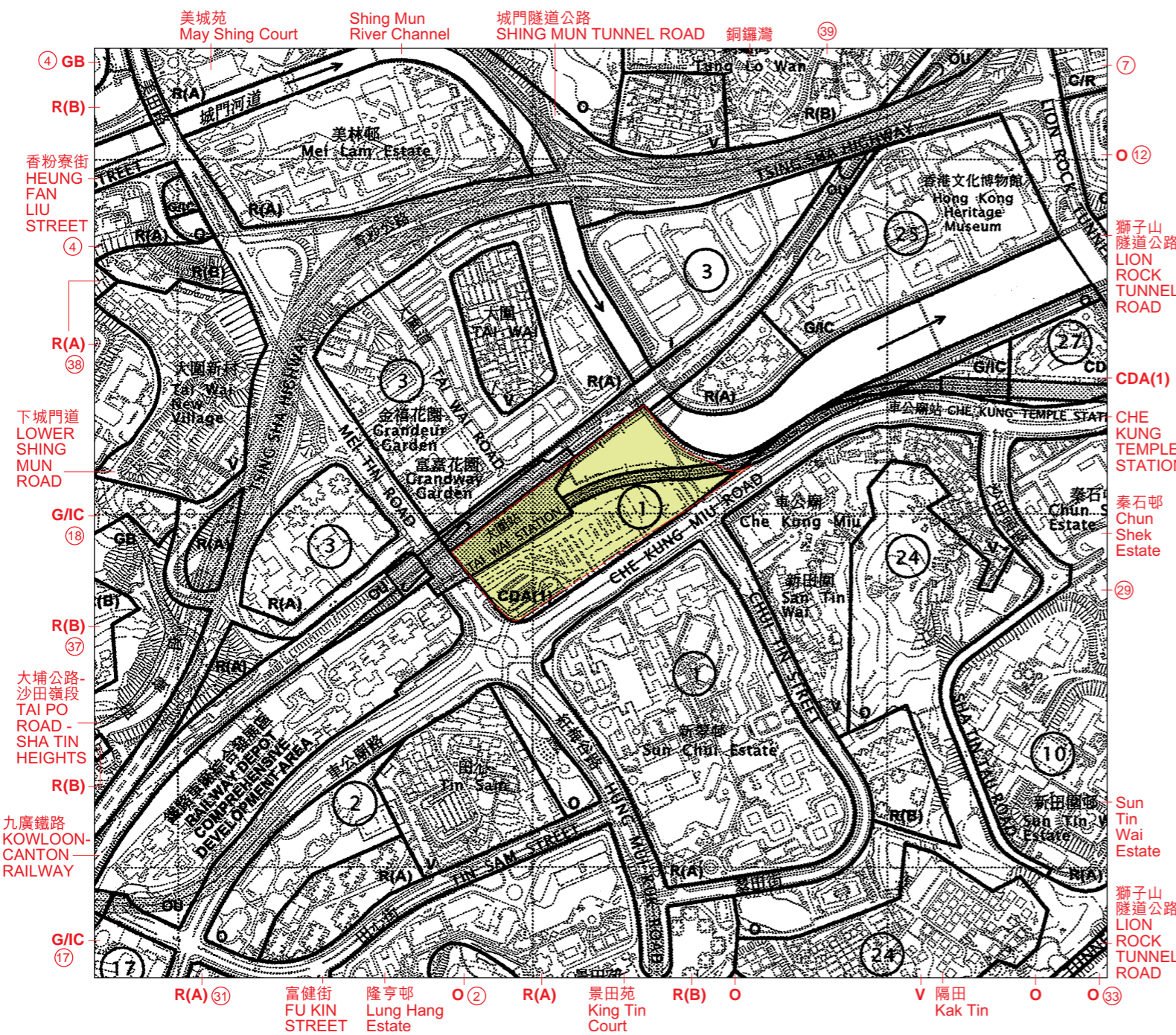

Location of the Development
 發展項目的位置

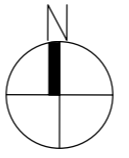

Notation 圖例

Zones 地帶

Comprehensive Development Area 綜合發展區	CDA
Commercial / Residential 商業 / 住宅	C/R
Residential (Group A) 住宅(甲類)	R(A)
Residential (Group B) 住宅(乙類)	R(B)
Village Type Development 鄉村式發展	V
Industrial 工業	I
Government, Institution Or Community 政府、機構或社區	G/I/C
Open Space 休憩用地	O
Other Specified Uses 其他指定用途	OU
Green Belt 綠化地帶	GB

Communications 交通

Railway And Station (Elevated) 鐵路及車站(高架)	
Major Road And Junction 主要道路及路口	
Elevated Road 高架道路	

Miscellaneous 其他

Planning Area Number 規劃區編號	①
----------------------------	---

Remarks:

- The last updated version of the Outline Zoning Plan and the attached schedule as of the date of printing of the sales brochure are available for free inspection during normal office hours at the sales office.
- The above Outline Zoning Plan, prepared by the Planning Department under the direction of the Town Planning Board, is reproduced with permission of the Director of Lands. © The Government of the Hong Kong SAR.
- The vendor advises prospective purchasers to conduct an on-site visit for a better understanding of the development site, its surrounding environment and the public facilities nearby.
- Due to technical reasons that the boundary of the Development is irregular, the Outline Zoning Plan has shown more than the area required under the Residential Properties (First-hand Sales) Ordinance.

備註:

- 在印製售樓說明書當日適用的最近更新版本分區計劃大綱圖及其附表存於售樓處，於正常辦公時間內供免費查閱。
- 上述分區計劃大綱圖為規劃署遵照城市規劃委員會指示擬備，版權屬香港特別行政區政府，經地政總署准許複印。
- 賣方建議準買方到有關發展地盤作實地考察，以對該發展地盤、其周邊地區環境及附近的公共設施有較佳了解。
- 因發展項目的不規則界線引致的技術原因，分區計劃大綱圖所顯示的範圍多於《一手住宅物業銷售條例》所要求。

Layout plan of the development 發展項目的布局圖

The estimated date of completion of the buildings and facilities in the Development, as provided by the Authorized Person for the Development:

由發展項目的認可人士提供的發展項目內的建築物及設施的預計落成日期：

Phase 期數	Buildings and Facilities 建築物及設施	Estimated Date of Completion 預計落成日期
1	Tower 2, Tower 3 and Facilities of Phase 1 第2座、第3座及第1期之設施	30 June 2022 2022年6月30日
2	Tower 5, Tower 6, Tower 7 and Facilities of Phase 2 第5座、第6座、第7座及第2期之設施	31 August 2022 2022年8月31日
3	Tower 1, Tower 8 and Facilities of Phase 3 第1座、第8座及第3期之設施	4 August 2023 2023年8月4日
4	Commercial Development, Bicycle Park, Public Transport Interchange and Facilities of Phase 4 商業發展項目、自行車停車場、公共運輸交匯處及第4期之設施	30 June 2022 2022年6月30日
5	Post Secondary College (Structural Shell and External Façade) and Facilities of Phase 5 專上教育學院(結構外殼及外正面)及第5期之設施	30 June 2022 2022年6月30日

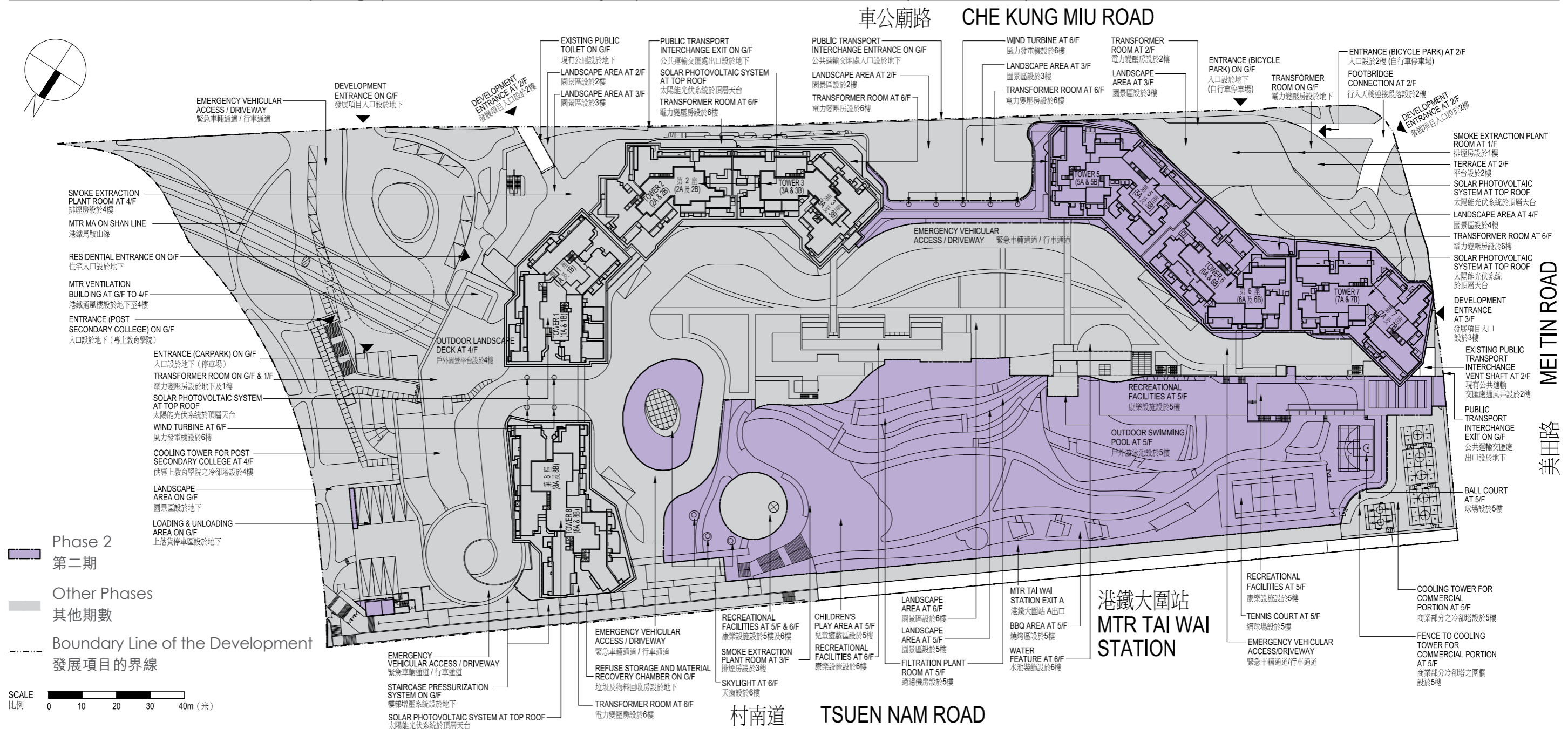

Remarks :

- Floodlights will be provided for lighting of the outdoor swimming pool of the Development in the evening. Prospective purchasers please note the impact (if any) of the illumination of such lighting system on individual residential unit.
- Mass Transit Railway ("MTR") ventilation building, cooling tower for Post Secondary College and commercial portion, fence to cooling tower for commercial portion and existing vent shaft for Public Transport Interchange forming parts of the Development may affect the view of the residential properties at lower floors.
- MTR ventilation building, residents' clubhouse water feature, cooling tower for Post Secondary College and commercial portion, smoke extraction system for commercial portion, staircase pressurization system serving basement and existing vent shaft for Public Transport Interchange forming parts of the Development may emit sounds and affect the enjoyment to the residential properties.

備註：

- 發展項目之室外泳池會裝設泛光燈以供室外泳池的晚間照明。請準買家注意該等照明系統的照明對個別住宅單位造成的影響(如有)。
- 組成發展項目一部分的港鐵通風樓、專上教育學院和商業部分之冷卻塔、商業部分冷卻塔之圍欄及公共運輸交匯處的通風口可能會影響位於低層住宅物業的景觀。
- 組成發展項目一部分的港鐵通風樓、住客會所的水池裝飾、專上教育學院和商業部分之冷卻塔、商業部分之排煙系統、地庫之樓梯增壓系統及公共運輸交匯處的通風口可能釋放聲音及對享用住宅物業造成影響。

Floor plans of residential properties in the phase 期數的住宅物業的樓面平面圖

Remarks applicable to the floor plans in this section:

1. There are architectural features, metal grilles and/or exposed pipes on the external walls of some of the floors. For details, please refer to the latest approved building plans and/or approved drainage plans and/or other relevant plans.
2. Common pipes exposed and/or enclosed in cladding are located at/adjacent to the balcony and/or utility platform and/or flat roof and/or air-conditioner platform and/or external wall of some residential properties. For details, please refer to the latest approved building plans and/or approved drainage plans and/or other relevant plans.
3. There are sunken slabs for mechanical and electrical services and/or false ceiling/bulkheads for the air-conditioning fittings and/or mechanical and electrical services at some residential properties.
4. There are exposed pipes installed in some stores, utility rooms, bathrooms, and toilets.
5. There are pipes enclosed by the fittings and finishes in some residential properties. For details, please refer to the latest approved drainage plans and/or other relevant plans.
6. The air-conditioner (outdoor unit) at air-conditioner platform may emit sounds.
7. Balconies and utility platforms are non-enclosed areas.
8. There are non-structural prefabricated external walls in some residential properties. The Saleable Area as defined in the formal Agreement for Sale and Purchase of a residential property has included the non-structural prefabricated external walls and is measured from the exterior of such non-structural prefabricated external walls.
9. The ceiling height of some residential properties may vary due to structural, architectural and/or decoration design variations.
10. During the necessary maintenance of the external walls of towers arranged by Manager of the Phase, suspended working platform will be operating in the airspace outside windows of the residential properties and above flat roof / roof of such towers.
11. Symbols of fittings and fitments such as bath tub, sink, water closet, shower, sink counter, etc. in the floor plans are prepared based on the latest approved building plans and are for general indication only.
12. There is a TV relay station located at SMATV Room (RESID) at roof of Tower 5.

適用於本節之樓面平面圖之備註：

1. 部分樓層外牆範圍設有建築裝飾、金屬格柵及/或外露喉管，詳細資料請參考最新經批准的建築圖則及/或經批准的排水設施圖則及/或其他相關圖則。
2. 部分住宅物業的露台及/或工作平台及/或平台及/或空調機平台及/或外牆上/附近設有外露及/或外牆覆蓋板內藏之公用喉管，詳細資料請參考最新經批准的建築圖則及/或經批准的排水設施圖則及/或其他相關圖則。
3. 部分住宅物業有用以安裝機電設備的跌級樓板及/或用以裝置空調裝備及/或其他機電設備的假天花/裝飾橫樑。
4. 部分儲物房、工作間、浴室及洗手間內裝有外露喉管。
5. 部分住宅物業於裝置及裝修物料內設有喉管。詳細資料請參考經批准的排水設施圖則及其他相關圖則。
6. 空調機(室外機)於空調機平台可能釋放聲音。
7. 露台及工作平台為不可封閉的地方。
8. 部分住宅物業有非結構預製外牆。正式買賣合約之實用面積之計算包括非結構預製外牆，並由非結構預製外牆之外圍起計。
9. 部分住宅物業之天花高度將會因應結構、建築設計及/或裝修設計上的需要有所差異。
10. 在期數管理人安排於大廈外牆之必要維修進行期間，吊船將在該等大廈的住宅物業之窗戶外及平台/天台上之空間運作。
11. 樓面平面圖上所顯示的裝置符號，如浴缸、洗滌盆、坐廁、花灑、洗滌盆櫃等乃按最新的經批准的建築圖則繪製，只作一般示意用途。
12. 電視轉播站設置於第5座天台之衛星電視共用天線房(住宅)。

Legend for floor plans of residential properties in the Phase 期數的住宅物業的樓面平面圖圖例

ACOUSTIC BALCONY (BAFFLE TYPE)	=	減音露台(擋音式)
ACOUSTIC WINDOW (BAFFLE TYPE)	=	減音窗戶(擋音式)
ACOUSTIC UP (BAFFLE TYPE)	=	減音工作平台(擋音式)
A/C	=	空調機平台
AD	=	通風槽
AF	=	建築裝飾
ALUM AF	=	鋁質建築裝飾
ALUM AF WITH CW BELOW	=	鋁質建築裝飾與設於下方的玻璃幕牆
BATH	=	浴室
BAL	=	露台
BAL ABOVE	=	露台設於上方
BALCONY WITH ACOUSTIC CEILING	=	配有減音天花的露台
BR	=	睡房
CANOPY	=	簷篷
CORRIDOR	=	走廊
CFR	=	公用平台
D	=	下
DOGHOUSE	=	連接下層的機電設施管道
DIN	=	飯廳
EAD	=	抽風槽
ELV	=	低電壓槽
ELE	=	電線槽/電錶房
FR	=	平台
HR	=	消防喉轆
KIT	=	廚房
LIFT	=	升降機
LIFT LOBBY	=	升降機大堂
LIFT SHAFT	=	升降機槽
LIV	=	客廳
MAINTENANCE ACCESS	=	檢修通道
MAINTENANCE WINDOW FOR A/C	=	空調機平台維修用窗
MBR	=	主人睡房
OPEN KIT	=	開放式廚房
PD	=	管道槽
PLANTER	=	花槽
PW	=	管道井
ROOF	=	天台
RSMRR	=	垃圾及物料回收室
SERVICE LIFT	=	服務升降機
SERVICE LIFT LOBBY	=	服務升降機大堂
ST	=	儲物房
T	=	洗手間
T5A	=	第5座(5A)
T5B	=	第5座(5B)
T6A	=	第6座(6A)
T6B	=	第6座(6B)
T7A	=	第7座(7A)
T7B	=	第7座(7B)
U	=	上
UP	=	工作平台
UP ABOVE	=	工作平台設於上方
UTL	=	工作間
WMC	=	水錶箱
		Acoustic Utility Platform (Baffle Type)
		Air-conditioner Platform
		Air Duct
		Architectural Feature
		Aluminium Architectural Feature
		Aluminium Architectural Feature with Curtain Wall below
		Bathroom
		Balcony
		Balcony above
		Bedroom
		Common Flat Roof
		Down
		Mechanical and Electrical Services Duct connecting to the Floor below
		Dining Room
		Exhaust Air Duct
		Extra Low Voltage Riser Duct
		Electrical Duct / Meter Room
		Flat Roof
		Hose Reel
		Kitchen
		Living Room
		Maintenance Window for Air-conditioner Platform
		Master Bedroom
		Open Kitchen
		Pipe Duct
		Pipe Well
		Refuse Storage and Material Recovery Room
		Service Lift
		Service Lift Lobby
		Store
		Toilet
		Tower 5 (5A)
		Tower 5 (5B)
		Tower 6 (6A)
		Tower 6 (6B)
		Tower 7 (7A)
		Tower 7 (7B)
		Up
		Utility Platform
		Utility Platform above
		Utility Room
		Water Meter Cabinet

Floor plans of residential properties in the phase 期數的住宅物業的樓面平面圖

Tower 5 (5A & 5B) 7/F
第5座 (5A及5B) 7樓

Description 描述	Tower 5 (5A) 第5座 (5A)					Tower 5 (5B) 第5座 (5B)			
	Flat 單位					Flat 單位			
	A	B	C	D	E	A	B	C	D
Floor-to-floor height (refers to the height between the top surface of the structural slab of a floor and the top surface of the structural slab of its immediate upper floor) of each residential property (m) 每個住宅物業的層與層之間的高度 (指該樓層之石屎地台面與上一層石屎地台面之高度距離) (米)	2.735 3.035 3.185 3.235 3.535	2.685 2.735 2.935 3.035 3.185 3.235 3.435 3.535	2.585 2.710 2.735 3.035 3.085 3.185 3.210 3.235 3.535	2.735 3.035 3.210 3.435 3.535	2.910 3.035 3.210 3.285 3.410 3.435 3.535	2.935 3.035 3.185 3.235 3.435 3.535	2.685 2.735 3.035 3.185 3.235 3.435 3.535	2.735 3.035 3.210 3.235 3.435 3.535	
Thickness of the floor slabs (excluding plaster) of each residential property (mm) 每個住宅物業的樓板 (不包括灰泥) 厚度 (毫米)	150 300		150 175		150 175 300	150	150 300		150 175

The internal areas of the residential properties on the upper floors will generally be slightly larger than those on the lower floors because of the reducing thickness of the structural walls on the upper floors (Note: This statement as required under section 10(2)(e) of Part 1 of Schedule 1 to the Residential Properties (First-hand Sales) Ordinance is not applicable to the Phase).

因住宅物業的較高樓層的結構牆的厚度遞減，較高樓層的內部面積，一般比較低樓層的內部面積稍大(備註：此《一手住宅物業銷售條例》附表1第1部第10(2)(e)條規定之陳述並不適用於期數)。

Remarks :

1. The dimensions in the floor plans are all structural dimensions in millimetre and rounded off to the nearest integer.
2. For details of the noise mitigation measures, please refer to the Relevant Information section in this sales brochure.
3. Please refer to Page 23 of this sales brochure for legend of the terms and abbreviations shown in the floor plan.

備註：

1. 樓面平面圖之尺規所列數字為以毫米標示之建築結構尺寸，並以四捨五入至整數。
2. 有關紓緩噪音措施之詳情，請參閱本售樓說明書的有關資料章節。
3. 平面圖中顯示之名詞及簡稱之圖例請參閱本售樓說明書第23頁。

Floor plans of residential properties in the phase 期數的住宅物業的樓面平面圖

Tower 5 (5A & 5B)
第5座 (5A及5B) 7/F
7樓

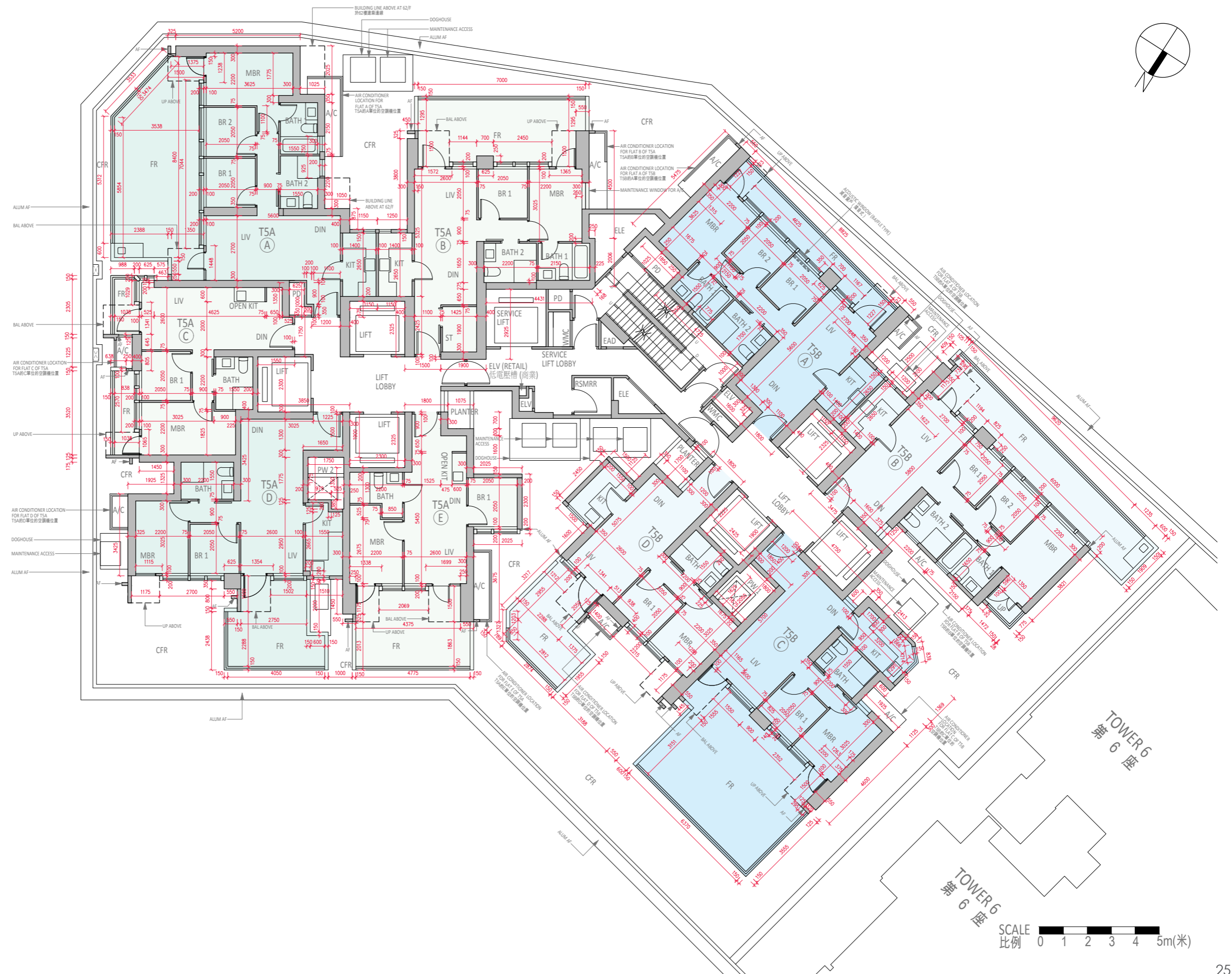

TOWER 6
第6座

TOWER 6
第6座

SCALE
比例 0 1 2 3 4 5m(米)

Floor plans of residential properties in the phase 期數的住宅物業的樓面平面圖

Tower 5 (5A & 5B) 8/F-12/F, 15/F-16/F, 18/F-23/F, 25/F-33/F, 35/F-39/F, 41/F-43/F, 45/F-53/F & 55/F-61/F (13/F, 14/F, 24/F, 34/F, 44/F and 54/F are omitted)
第5座 (5A及5B) 8樓至12樓, 15樓至16樓, 18樓至23樓, 25樓至33樓, 35樓至39樓, 41樓至43樓, 45樓至53樓及55樓至61樓 (不設13樓、14樓、24樓、34樓、44樓及54樓)

Description 描述	Floor 樓層	Tower 5 (5A) 第5座 (5A)					Tower 5 (5B) 第5座 (5B)			
		Flat 單位					Flat 單位			
		A	B	C	D	E	A	B	C	D
Floor-to-floor height (refers to the height between the top surface of the structural slab of a floor and the top surface of the structural slab of its immediate upper floor) of each residential property (m) 每個住宅物業的層與層之間的高度 (指該樓層之石屎地台面與上一層石屎地台面之高度距離) (米)	8/F-12/F, 15/F, 18/F-23/F, 25/F-33/F, 35/F-38/F, 41/F-43/F, 45/F-53/F & 55/F-60/F 8樓至12樓、15樓、18樓至23樓、25樓至33樓、35樓至38樓、41樓至43樓、45樓至53樓及55樓至60樓	3.035					3.035			
	16/F 16樓	3.035 3.335 3.385	3.035 3.135 3.335 3.385	3.035, 3.110 3.135, 3.335 3.385, 3.435 3.485	3.035 3.110 3.210 3.335 3.435	3.035 3.135 3.160 3.285 3.360	3.035 3.135 3.335 3.385		3.035 3.135 3.335 3.360	
	39/F 39樓	3.035 3.335 3.385	3.035 3.135 3.335 3.385	3.035, 3.110 3.135, 3.335 3.360, 3.385 3.485	3.035 3.110 3.135 3.335 3.360	3.035 3.135 3.160 3.285 3.360	3.035 3.135 3.335 3.385		3.035 3.135 3.335 3.360	
	61/F 61樓	3.040, 3.090 3.290, 3.390 3.440, 3.640 3.690, 3.740	3.390	3.090, 3.390 3.540, 3.690 3.715, 3.740 3.840	3.390	3.390	3.040 3.140 3.290 3.340 3.390 3.490 3.740	3.040, 3.190 3.315, 3.340 3.390, 3.490 3.565, 3.690 3.740	3.390	
Thickness of the floor slabs (excluding plaster) of each residential property (mm) 每個住宅物業的樓板 (不包括灰泥) 厚度 (毫米)	8/F-12/F, 15/F, 18/F-23/F, 25/F-33/F, 35/F-38/F, 41/F-43/F, 45/F-53/F & 55/F-60/F 8樓至12樓、15樓、18樓至23樓、25樓至33樓、35樓至38樓、41樓至43樓、45樓至53樓及55樓至60樓	150 300		150 175		150 175 300	150	150 300		150 175 300
	16/F 16樓	150 300		150 250	150 175 250	150 175 300	150	150 300		150 175 300
	39/F 39樓	150 300		150 175 250		150 175 300	150	150 300		150 175 300
	61/F 61樓	150 200 300	150 300	150 175		150 175 300	150 300	150 300		150 175 300

The internal areas of the residential properties on the upper floors will generally be slightly larger than those on the lower floors because of the reducing thickness of the structural walls on the upper floors (Note: This statement as required under section 10(2)(e) of Part 1 of Schedule 1 to the Residential Properties (First-hand Sales) Ordinance is not applicable to the Phase).

因住宅物業的較高樓層的結構牆的厚度遞減，較高樓層的內部面積，一般比較低樓層的內部面積稍大(備註：此《一手住宅物業銷售條例》附表1第1部第10(2)(e)條規定之陳述並不適用於期數)。

Remarks :

- The dimensions in the floor plans are all structural dimensions in millimetre and rounded off to the nearest integer.
- For details of the noise mitigation measures, please refer to the Relevant Information section in this sales brochure.
- Please refer to Page 23 of this sales brochure for legend of the terms and abbreviations shown in the floor plan.

備註：

- 樓面平面圖之尺規所列數字為以毫米標示之建築結構尺寸，並以四捨五入至整數。
- 有關舒緩噪音措施之詳情，請參閱本售樓說明書的有關資料章節。
- 平面圖中顯示之名稱及簡稱之圖例請參閱本售樓說明書第23頁。

Floor plans of residential properties in the phase 期數的住宅物業的樓面平面圖

Tower 5 (5A & 5B)
8/F-12/F, 15/F-16/F,
18/F-23/F, 25/F-33/F,
35/F-39/F, 41/F-43/F,
45/F-53/F & 55/F-61/F
(13/F, 14/F, 24/F, 34/F, 44/F
and 54/F are omitted)

第5座 (5A及5B)
8樓至12樓, 15樓至16樓,
18樓至23樓, 25樓至33樓,
35樓至39樓, 41樓至43樓,
45樓至53樓及55樓至61樓
(不設13樓、14樓、24樓、
34樓、44樓及54樓)



Floor plans of residential properties in the phase 期數的住宅物業的樓面平面圖

Tower 5 (5A & 5B) 62/F
第5座 (5A及5B) 62樓

Description 描述	Tower 5 (5A) 第5座 (5A)				Tower 5 (5B) 第5座 (5B)		
	Flat 單位				Flat 單位		
	A	B	D	E	A	C	D
Floor-to-floor height (refers to the height between the top surface of the structural slab of a floor and the top surface of the structural slab of its immediate upper floor) of each residential property (m) 每個住宅物業的層與層之間的高度 (指該樓層之石屎地台面與上一層石屎地台面之高度距離) (米)	3.500 3.600 3.800 3.850		3.500 3.600 3.800 3.825	3.500 3.600 3.625 3.750 3.825	3.500 3.600 3.700 3.750 3.850	3.500 3.600 3.800 3.850	3.500 3.600 3.800 3.825
Thickness of the floor slabs (excluding plaster) of each residential property (mm) 每個住宅物業的樓板 (不包括灰泥) 厚度 (毫米)	175 200 250 300	200 300	200	200 300	200 300		

The internal areas of the residential properties on the upper floors will generally be slightly larger than those on the lower floors because of the reducing thickness of the structural walls on the upper floors (Note: This statement as required under section 10(2)(e) of Part 1 of Schedule 1 to the Residential Properties (First-hand Sales) Ordinance is not applicable to the Phase).

因住宅物業的較高樓層的結構牆的厚度遞減，較高樓層的內部面積，一般比較低樓層的內部面積稍大(備註：此《一手住宅物業銷售條例》附表1第1部第10(2)(e)條規定之陳述並不適用於期數)。

Remarks :

1. The dimensions in the floor plans are all structural dimensions in millimetre and rounded off to the nearest integer.
2. For details of the noise mitigation measures, please refer to the Relevant Information section in this sales brochure.
3. Please refer to Page 23 of this sales brochure for legend of the terms and abbreviations shown in the floor plan.

備註：

1. 樓面平面圖之尺規所列數字為以毫米標示之建築結構尺寸，並以四捨五入至整數。
2. 有關紓緩噪音措施之詳情，請參閱本售樓說明書的有關資料章節。
3. 平面圖中顯示之名詞及簡稱之圖例請參閱本售樓說明書第23頁。

Floor plans of residential properties in the phase 期數的住宅物業的樓面平面圖

Tower 5 (5A & 5B)
第5座 (5A及5B)

62/F
62樓

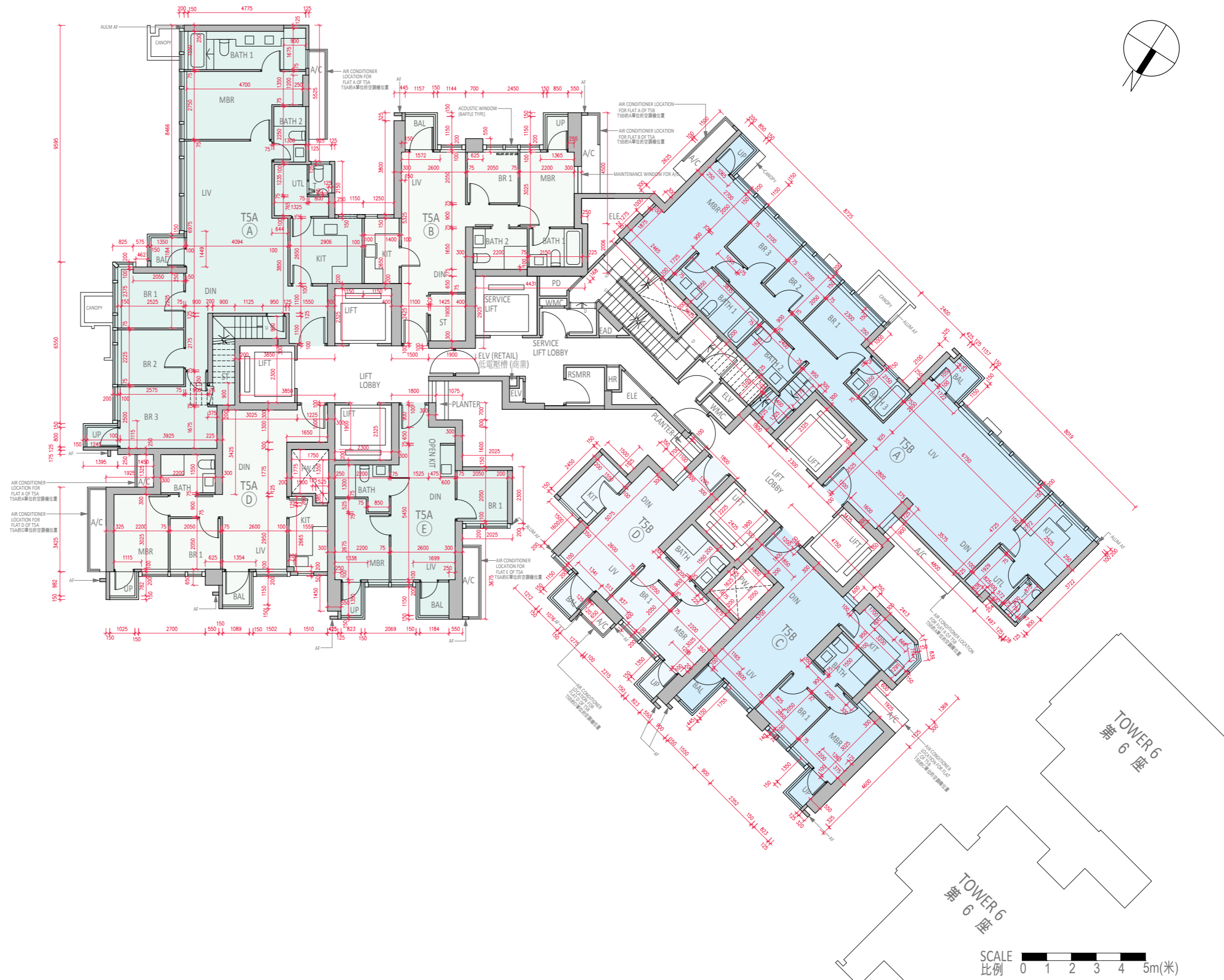

Floor plans of residential properties in the phase 期數的住宅物業的樓面平面圖

Tower 5 (5A & 5B) ROOF
第5座 (5A及5B) 天台

Description 描述	Tower 5 (5A) 第5座 (5A)				Tower 5 (5B) 第5座 (5B)		
	Flat 單位				Flat 單位		
	A	B	D	E	A	C	D
Floor-to-floor height (refers to the height between the top surface of the structural slab of a floor and the top surface of the structural slab of its immediate upper floor) of each residential property (m) 每個住宅物業的層與層之間的高度 (指該樓層之石屎地台面與上一層石屎地台面之高度距離) (米)	Not Applicable 不適用				Not Applicable 不適用		
Thickness of the floor slabs (excluding plaster) of each residential property (mm) 每個住宅物業的樓板 (不包括灰泥) 厚度 (毫米)	Not Applicable 不適用				Not Applicable 不適用		

The internal areas of the residential properties on the upper floors will generally be slightly larger than those on the lower floors because of the reducing thickness of the structural walls on the upper floors (Note: This statement as required under section 10(2)(e) of Part 1 of Schedule 1 to the Residential Properties (First-hand Sales) Ordinance is not applicable to the Phase).

因住宅物業的較高樓層的結構牆的厚度遞減，較高樓層的內部面積，一般比較低樓層的內部面積稍大(備註：此《一手住宅物業銷售條例》附表1第1部第10(2)(e)條規定之陳述並不適用於期數)。

Remarks :

1. The dimensions in the floor plans are all structural dimensions in millimetre and rounded off to the nearest integer.
2. For details of the noise mitigation measures, please refer to the Relevant Information section in this sales brochure.
3. Please refer to Page 23 of this sales brochure for legend of the terms and abbreviations shown in the floor plan.

備註：

1. 樓面平面圖之尺規所列數字為以毫米標示之建築結構尺寸，並以四捨五入至整數。
2. 有關紓緩噪音措施之詳情，請參閱本售樓說明書的有關資料章節。
3. 平面圖中顯示之名詞及簡稱之圖例請參閱本售樓說明書第23頁。

Floor plans of residential properties in the phase 期數的住宅物業的樓面平面圖

Tower 5 (5A & 5B)
第5座 (5A及5B)

ROOF
天台

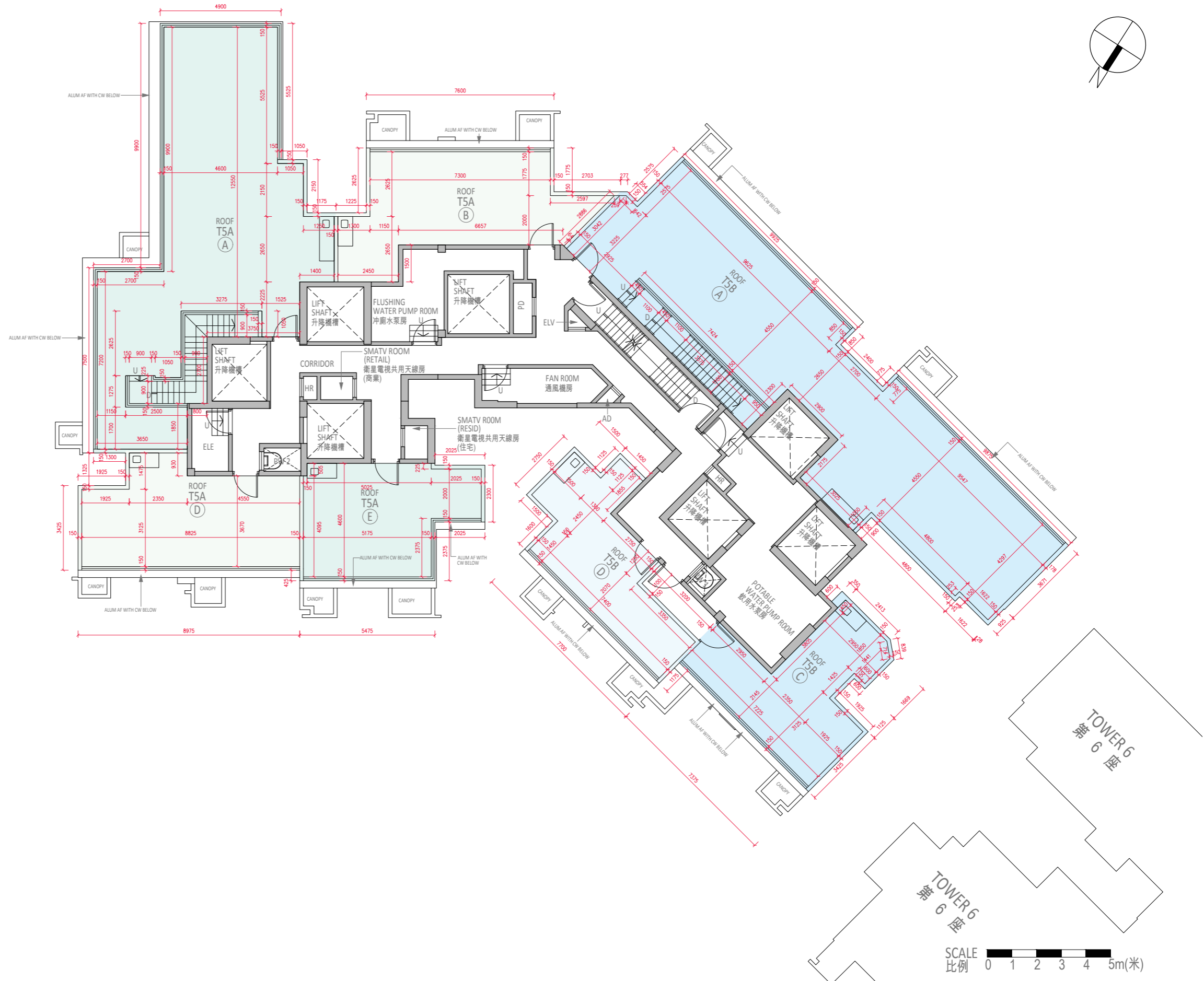

Floor plans of residential properties in the phase 期數的住宅物業的樓面平面圖

Tower 6 (6A & 6B) 7/F
第6座 (6A及6B) 7樓

Description 描述	Tower 6 (6A) 第6座 (6A)					Tower 6 (6B) 第6座 (6B)				
	Flat 單位					Flat 單位				
	A	B	C	D	E	A	C	D	E	F
Floor-to-floor height (refers to the height between the top surface of the structural slab of a floor and the top surface of the structural slab of its immediate upper floor) of each residential property (m) 每個住宅物業的層與層之間的高度 (指該樓層之石屎地台面與上一層石屎地台面之高度距離) (米)	2.735 2.935 3.035 3.185 3.235 3.435 3.535	2.935 3.035 3.185 3.235 3.435 3.535	2.710 3.035 3.210 3.285 3.435 3.535	2.785 3.035 3.185 3.285 3.435 3.535	2.735 3.035 3.235 3.435 3.535	2.685 3.035 3.185 3.235 3.435 3.535		2.685 2.685 3.035 3.185 3.535	2.785 3.035 3.210 3.285 3.435 3.535	3.035 3.235 3.435 3.535
Thickness of the floor slabs (excluding plaster) of each residential property (mm) 每個住宅物業的樓板 (不包括灰泥) 厚度 (毫米)	150 300		150 175	150	150 200 300	150		150 175	150 200 300	

The internal areas of the residential properties on the upper floors will generally be slightly larger than those on the lower floors because of the reducing thickness of the structural walls on the upper floors (Note: This statement as required under section 10(2)(e) of Part 1 of Schedule 1 to the Residential Properties (First-hand Sales) Ordinance is not applicable to the Phase).

因住宅物業的較高樓層的結構牆的厚度遞減，較高樓層的內部面積，一般比較低樓層的內部面積稍大(備註：此《一手住宅物業銷售條例》附表1第1部第10(2)(e)條規定之陳述並不適用於期數)。

Remarks :

1. The dimensions in the floor plans are all structural dimensions in millimetre and rounded off to the nearest integer.
2. For details of the noise mitigation measures, please refer to the Relevant Information section in this sales brochure.
3. Please refer to Page 23 of this sales brochure for legend of the terms and abbreviations shown in the floor plan.

備註：

1. 樓面平面圖之尺規所列數字為以毫米標示之建築結構尺寸，並以四捨五入至整數。
2. 有關紓緩噪音措施之詳情，請參閱本售樓說明書的有關資料章節。
3. 平面圖中顯示之名詞及簡稱之圖例請參閱本售樓說明書第23頁。

Floor plans of residential properties in the phase
期數的住宅物業的樓面平面圖

Tower 6 (6A & 6B)
第6座 (6A及6B)

7/F
7樓



TOWER 7
第 7 座

TOWER 7
第 7 座

SCALE
比例 0 1 2 3 4 5m(米)

Floor plans of residential properties in the phase 期數的住宅物業的樓面平面圖

Tower 6 (6A & 6B) 8/F-12/F, 15/F-16/F, 18/F-23/F, 25/F-33/F & 35/F-39/F (13/F, 14/F, 24/F and 34/F are omitted)
第6座 (6A及6B) 8樓至12樓, 15樓至16樓, 18樓至23樓, 25樓至33樓及35樓至39樓 (不設13樓、14樓、24樓及34樓)

Description 描述	Floor 樓層	Tower 6 (6A) 第6座 (6A)					Tower 6 (6B) 第6座 (6B)				
		Flat 單位					Flat 單位				
		A	B	C	D	E	A	C	D	E	F
Floor-to-floor height (refers to the height between the top surface of the structural slab of a floor and the top surface of the structural slab of its immediate upper floor) of each residential property (m) 每個住宅物業的層與層之間的高度 (指該樓層之石屎地台面與上一層石屎地台面之高度距離) (米)	8/F-12/F, 15/F, 18/F-23/F, 25/F-33/F & 35/F-38/F 8樓至12樓、15樓、18樓至23樓、25樓至33樓及35樓至38樓	3.035					3.035				
	16/F 16樓	3.035 3.135 3.335 3.385	3.035 3.135 3.360	3.035 3.135 3.285 3.385	3.035 3.135 3.335	3.035 3.135 3.235 3.335 3.485	3.035 3.135 3.335 3.385	3.035 3.135 3.385	3.035 3.135 3.285 3.360	3.035 3.135 3.335	
	39/F 39樓	3.035 3.135 3.335 3.385	3.035 3.135 3.360	3.035 3.135 3.385	3.035 3.085 3.185 3.385	3.035 3.135 3.335 3.385	3.035 3.135 3.385	3.035 3.135 3.285 3.360	3.035 3.135 3.335		
Thickness of the floor slabs (excluding plaster) of each residential property (mm) 每個住宅物業的樓板 (不包括灰泥) 厚度 (毫米)	8/F-12/F, 15/F, 18/F-23/F, 25/F-33/F & 35/F-38/F 8樓至12樓、15樓、18樓至23樓、25樓至33樓及35樓至38樓	150 300	150 175	150	150 200 300	150		150 175	150 200 300		
	16/F 16樓	150 300	150 175	150	150 200 300	150 250	150	150 175	150 200 300		
	39/F 39樓	150 300	150 175	150 250	150 200 250 300	150		150 175	150 200 300		

The internal areas of the residential properties on the upper floors will generally be slightly larger than those on the lower floors because of the reducing thickness of the structural walls on the upper floors (Note: This statement as required under section 10(2)(e) of Part 1 of Schedule 1 to the Residential Properties (First-hand Sales) Ordinance is not applicable to the Phase).

因住宅物業的較高樓層的結構牆的厚度遞減，較高樓層的內部面積，一般比較低樓層的內部面積稍大(備註：此《一手住宅物業銷售條例》附表1第1部第10(2)(e)條規定之陳述並不適用於期數)。

Remarks :

- The dimensions in the floor plans are all structural dimensions in millimetre and rounded off to the nearest integer.
- For details of the noise mitigation measures, please refer to the Relevant Information section in this sales brochure.
- Please refer to Page 23 of this sales brochure for legend of the terms and abbreviations shown in the floor plan.

備註：

- 樓面平面圖之尺規所列數字為以毫米標示之建築結構尺寸，並以四捨五入至整數。
- 有關紓緩噪音措施之詳情，請參閱本售樓說明書的有關資料章節。
- 平面圖中顯示之名詞及簡稱之圖例請參閱本售樓說明書第23頁。

Floor plans of residential properties in the phase 期數的住宅物業的樓面平面圖

Tower 6 (6A & 6B)
8/F-12/F, 15/F-16/F,
18/F-23/F, 25/F-33/F &
35/F-39/F
(13/F, 14/F, 24/F and
34/F are omitted)

第6座 (6A及6B)
8樓至12樓, 15樓至16樓,
18樓至23樓, 25樓至33樓
及35樓至39樓
(不設13樓、14樓、24樓
及34樓)

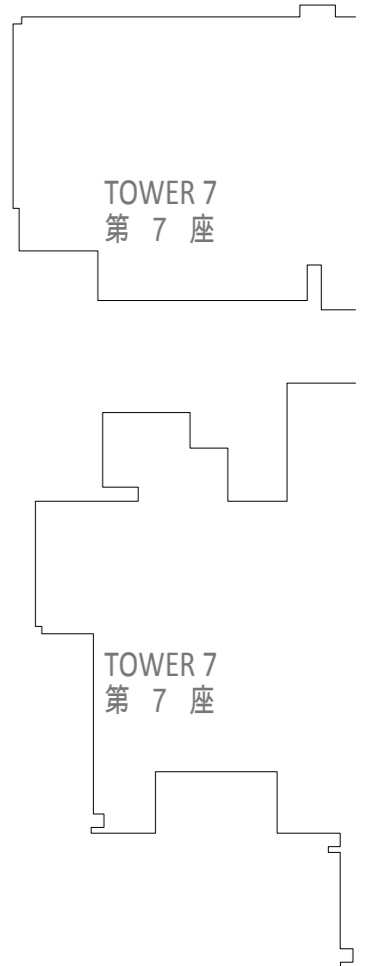
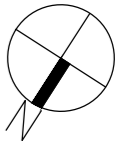
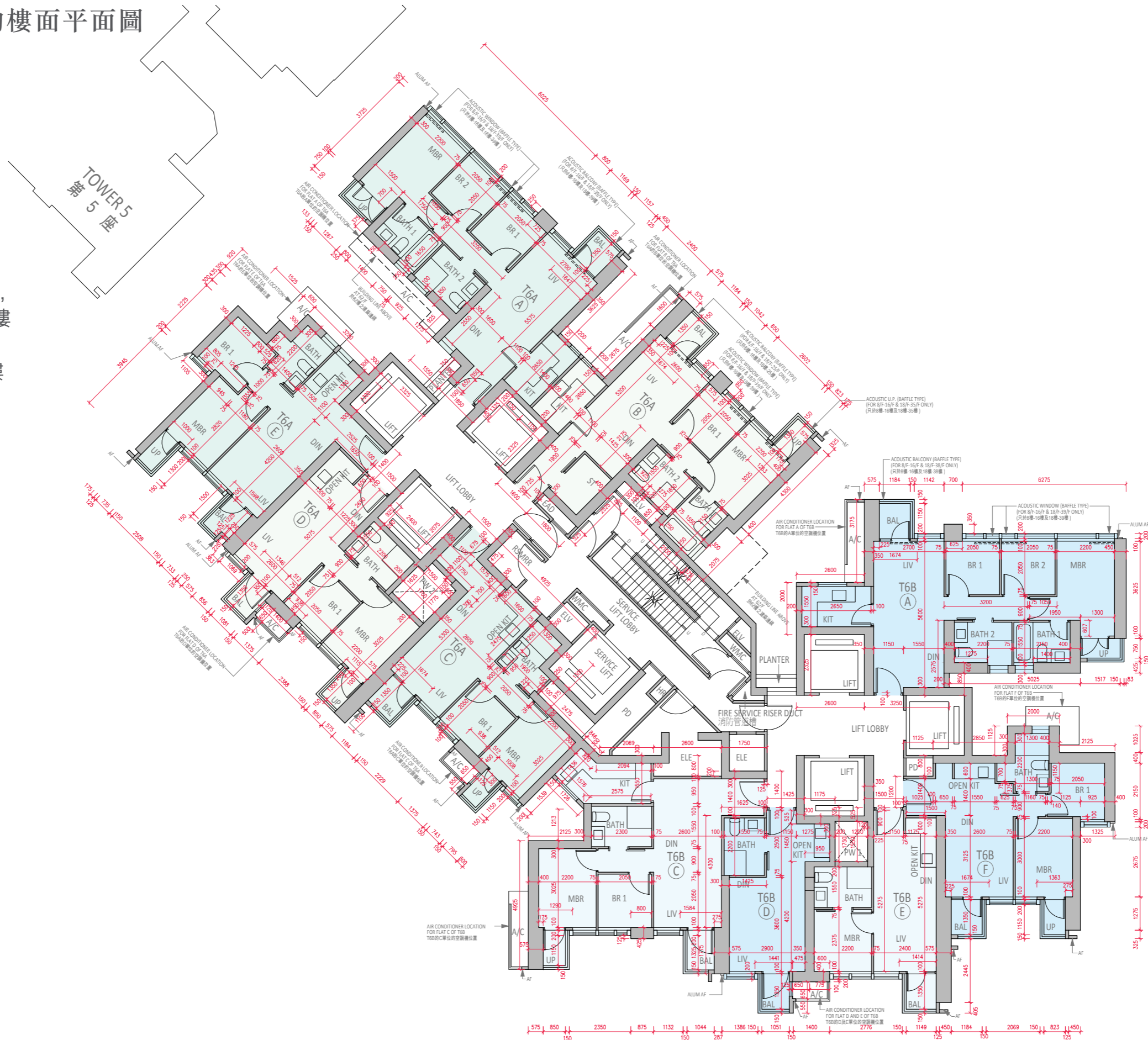

SCALE
比例 0 1 2 3 4 5m(米)

Floor plans of residential properties in the phase 期數的住宅物業的樓面平面圖

Tower 6 (6A & 6B) 41/F-43/F, 45/F-53/F & 55/F-61/F (44/F and 54/F are omitted)
第6座 (6A及6B) 41樓至43樓, 45樓至53樓及55樓至61樓 (不設44樓及54樓)

Description 描述	Floor 樓層	Tower 6 (6A) 第6座 (6A)					Tower 6 (6B) 第6座 (6B)			
		Flat 單位					Flat 單位			
		A	B	C	D	E	A	C	E	F
Floor-to-floor height (refers to the height between the top surface of the structural slab of a floor and the top surface of the structural slab of its immediate upper floor) of each residential property (m) 每個住宅物業的層與層之間的高度 (指該樓層之石屎地台面與上一層石屎地台面之高度距離) (米)	41/F-43/F, 45/F-53/F & 55/F-60/F 41樓至43樓, 45樓至53樓及55樓至60樓	3.035					3.035			
	61/F 61樓	3.040 3.140 3.190 3.340 3.390 3.490 3.640 3.740	3.040 3.190 3.340 3.390 3.490 3.690 3.740	3.390			3.390			
Thickness of the floor slabs (excluding plaster) of each residential property (mm) 每個住宅物業的樓板 (不包括灰泥) 厚度 (毫米)	41/F-43/F, 45/F-53/F & 55/F-60/F 41樓至43樓, 45樓至53樓及55樓至60樓	150 300	150 175	150	150 200 300	150	150 175	150 200 300		
	61/F 61樓	150 300	150 175	150	150 200 300	150	150 175	150 200 300		

The internal areas of the residential properties on the upper floors will generally be slightly larger than those on the lower floors because of the reducing thickness of the structural walls on the upper floors (Note: This statement as required under section 10(2)(e) of Part 1 of Schedule 1 to the Residential Properties (First-hand Sales) Ordinance is not applicable to the Phase).

因住宅物業的較高樓層的結構牆的厚度遞減，較高樓層的內部面積，一般比較低樓層的內部面積稍大(備註：此《一手住宅物業銷售條例》附表1第1部第10(2)(e)條規定之陳述並不適用於期數)。

Remarks :

- The dimensions in the floor plans are all structural dimensions in millimetre and rounded off to the nearest integer.
- For details of the noise mitigation measures, please refer to the Relevant Information section in this sales brochure.
- Please refer to Page 23 of this sales brochure for legend of the terms and abbreviations shown in the floor plan.

備註：

- 樓面平面圖之尺規所列數字為以毫米標示之建築結構尺寸，並以四捨五入至整數。
- 有關紓緩噪音措施之詳情，請參閱本售樓說明書的有關資料章節。
- 平面圖中顯示之名詞及簡稱之圖例請參閱本售樓說明書第23頁。

Floor plans of residential properties in the phase 期數的住宅物業的樓面平面圖

Tower 6 (6A & 6B)
41/F-43/F,
45/F-53/F &
55/F-61/F
(44/F and 54/F
are omitted)

第6座 (6A及6B)
41樓至43樓,
45樓至53樓及
55樓至61樓
(不設44樓及54樓)

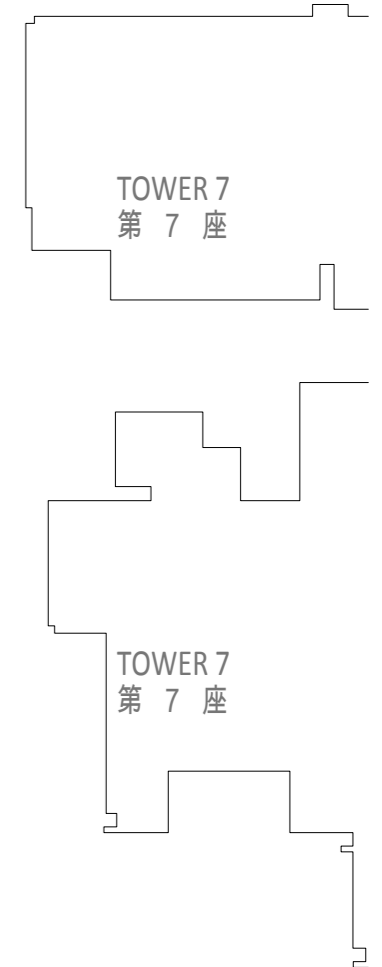
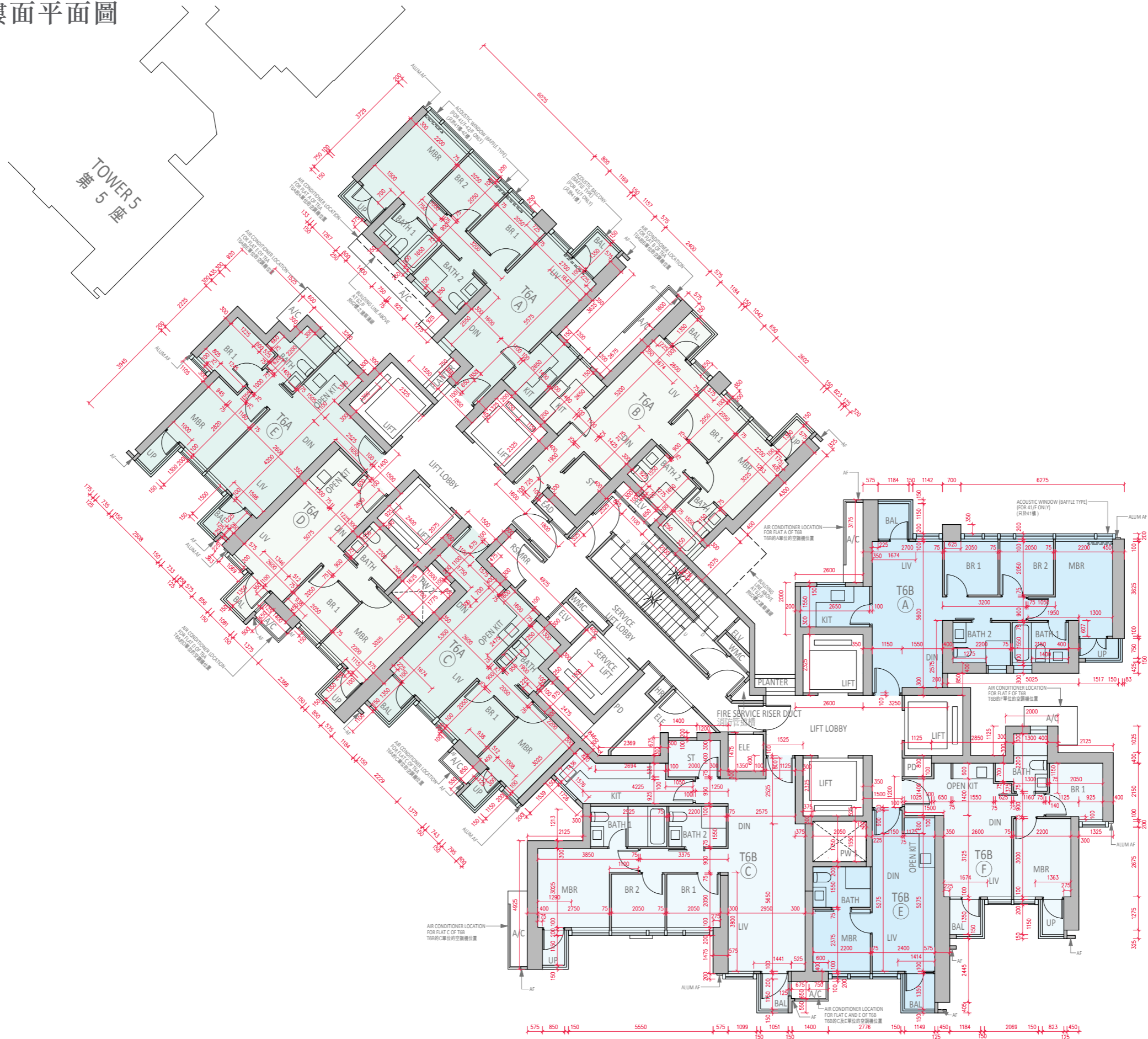

SCALE
比例 0 1 2 3 4 5m(米)

Floor plans of residential properties in the phase 期數的住宅物業的樓面平面圖

Tower 6 (6A & 6B) 62/F
第6座 (6A及6B) 62樓

Description 描述	Tower 6 (6A) 第6座 (6A)				Tower 6 (6B) 第6座 (6B)			
	Flat 單位				Flat 單位			
	A	C	D	E	A	C	E	F
Floor-to-floor height (refers to the height between the top surface of the structural slab of a floor and the top surface of the structural slab of its immediate upper floor) of each residential property (m) 每個住宅物業的層與層之間的高度 (指該樓層之石屎地台面與上一層石屎地台面之高度距離) (米)	3.500 3.600 3.700 3.850	3.500 3.600 3.825	3.500 3.600 3.750 3.850	3.500 3.600 3.800	3.500 3.600 3.800 3.850	3.500 3.600 3.625 3.750 3.850	3.500 3.600 3.750 3.825	3.500 3.600 3.800
Thickness of the floor slabs (excluding plaster) of each residential property (mm) 每個住宅物業的樓板 (不包括灰泥) 厚度 (毫米)	200 300	200	200 250	200 300	200			200 300

The internal areas of the residential properties on the upper floors will generally be slightly larger than those on the lower floors because of the reducing thickness of the structural walls on the upper floors (Note: This statement as required under section 10(2)(e) of Part 1 of Schedule 1 to the Residential Properties (First-hand Sales) Ordinance is not applicable to the Phase).

因住宅物業的較高樓層的結構牆的厚度遞減，較高樓層的內部面積，一般比較低樓層的內部面積稍大(備註：此《一手住宅物業銷售條例》附表1第1部第10(2)(e)條規定之陳述並不適用於期數)。

Remarks :

1. The dimensions in the floor plans are all structural dimensions in millimetre and rounded off to the nearest integer.
2. For details of the noise mitigation measures, please refer to the Relevant Information section in this sales brochure.
3. Please refer to Page 23 of this sales brochure for legend of the terms and abbreviations shown in the floor plan.

備註：

1. 樓面平面圖之尺規所列數字為以毫米標示之建築結構尺寸，並以四捨五入至整數。
2. 有關紓緩噪音措施之詳情，請參閱本售樓說明書的有關資料章節。
3. 平面圖中顯示之名詞及簡稱之圖例請參閱本售樓說明書第23頁。

Floor plans of residential properties in the phase 期數的住宅物業的樓面平面圖

Tower 6 (6A & 6B)
第6座 (6A及6B)

62/F
62樓

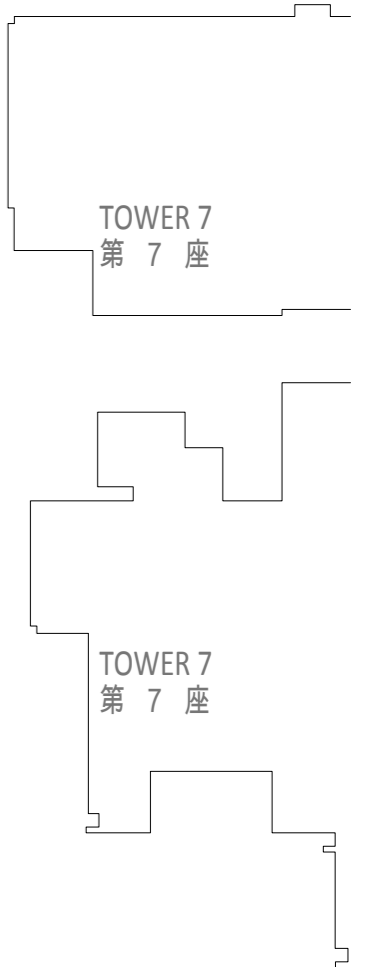
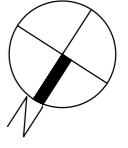

SCALE
比例 0 1 2 3 4 5m(米)

Floor plans of residential properties in the phase 期數的住宅物業的樓面平面圖

Tower 6 (6A & 6B) ROOF
第6座 (6A及6B) 天台

Description 描述	Tower 6 (6A) 第6座 (6A)				Tower 6 (6B) 第6座 (6B)			
	Flat 單位				Flat 單位			
	A	C	D	E	A	C	E	F
Floor-to-floor height (refers to the height between the top surface of the structural slab of a floor and the top surface of the structural slab of its immediate upper floor) of each residential property (m) 每個住宅物業的層與層之間的高度 (指該樓層之石屎地台面與上一層石屎地台面之高度距離) (米)	Not Applicable 不適用				Not Applicable 不適用			
Thickness of the floor slabs (excluding plaster) of each residential property (mm) 每個住宅物業的樓板 (不包括灰泥) 厚度 (毫米)	Not Applicable 不適用				Not Applicable 不適用			

The internal areas of the residential properties on the upper floors will generally be slightly larger than those on the lower floors because of the reducing thickness of the structural walls on the upper floors (Note: This statement as required under section 10(2)(e) of Part 1 of Schedule 1 to the Residential Properties (First-hand Sales) Ordinance is not applicable to the Phase).

因住宅物業的較高樓層的結構牆的厚度遞減，較高樓層的內部面積，一般比較低樓層的內部面積稍大(備註：此《一手住宅物業銷售條例》附表1第1部第10(2)(e)條規定之陳述並不適用於期數)。

Remarks :

1. The dimensions in the floor plans are all structural dimensions in millimetre and rounded off to the nearest integer.
2. For details of the noise mitigation measures, please refer to the Relevant Information section in this sales brochure.
3. Please refer to Page 23 of this sales brochure for legend of the terms and abbreviations shown in the floor plan.

備註：

1. 樓面平面圖之尺規所列數字為以毫米標示之建築結構尺寸，並以四捨五入至整數。
2. 有關紓緩噪音措施之詳情，請參閱本售樓說明書的有關資料章節。
3. 平面圖中顯示之名詞及簡稱之圖例請參閱本售樓說明書第23頁。

Floor plans of residential properties in the phase
期數的住宅物業的樓面平面圖

Tower 6 (6A & 6B)
第6座 (6A及6B)

ROOF
天台

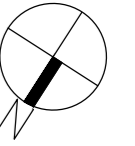

SCALE
比例 0 1 2 3 4 5m(米)

Floor plans of residential properties in the phase 期數的住宅物業的樓面平面圖

Tower 7 (7A & 7B) 7/F
第7座 (7A及7B) 7樓

Description 描述	Tower 7 (7A) 第7座 (7A)						Tower 7 (7B) 第7座 (7B)				
	Flat 單位						Flat 單位				
	A	B	C	D	E	F	A	B	C	D	E
Floor-to-floor height (refers to the height between the top surface of the structural slab of a floor and the top surface of the structural slab of its immediate upper floor) of each residential property (m) 每個住宅物業的層與層之間的高度 (指該樓層之石屎地台面與上一層石屎地台面之高度距離) (米)	3.035 3.185 3.235 3.435 3.535	2.935 3.035 3.185 3.235 3.435 3.535	3.035 3.235 3.285 3.435 3.535	2.785 2.935 3.035 3.210 3.285 3.435 3.535		2.685 3.035 3.210 3.185 3.435 3.535	3.035	3.035 3.185 3.235 3.435 3.535	2.710 3.035 3.210 3.435 3.535	2.685 2.735 2.935 3.035 3.185 3.235 3.435 3.535	3.035 3.210 3.235 3.435 3.535
Thickness of the floor slabs (excluding plaster) of each residential property (mm) 每個住宅物業的樓板 (不包括灰泥) 厚度 (毫米)	150 300	150	150 200 300	150 175	150	150 175	150	150 300	150 175	150 300	150 175 300

The internal areas of the residential properties on the upper floors will generally be slightly larger than those on the lower floors because of the reducing thickness of the structural walls on the upper floors (Note: This statement as required under section 10(2)(e) of Part 1 of Schedule 1 to the Residential Properties (First-hand Sales) Ordinance is not applicable to the Phase).

因住宅物業的較高樓層的結構牆的厚度遞減，較高樓層的內部面積，一般比較低樓層的內部面積稍大(備註：此《一手住宅物業銷售條例》附表1第1部第10(2)(e)條規定之陳述並不適用於期數)。

Remarks :

1. The dimensions in the floor plans are all structural dimensions in millimetre and rounded off to the nearest integer.
2. For details of the noise mitigation measures, please refer to the Relevant Information section in this sales brochure.
3. Please refer to Page 23 of this sales brochure for legend of the terms and abbreviations shown in the floor plan.

備註：

1. 樓面平面圖之尺規所列數字為以毫米標示之建築結構尺寸，並以四捨五入至整數。
2. 有關紓緩噪音措施之詳情，請參閱本售樓說明書的有關資料章節。
3. 平面圖中顯示之名詞及簡稱之圖例請參閱本售樓說明書第23頁。

Floor plans of residential properties in the phase 期數的住宅物業的樓面平面圖

Tower 7 (7A & 7B)
第7座 (7A及7B)

7/F
7樓

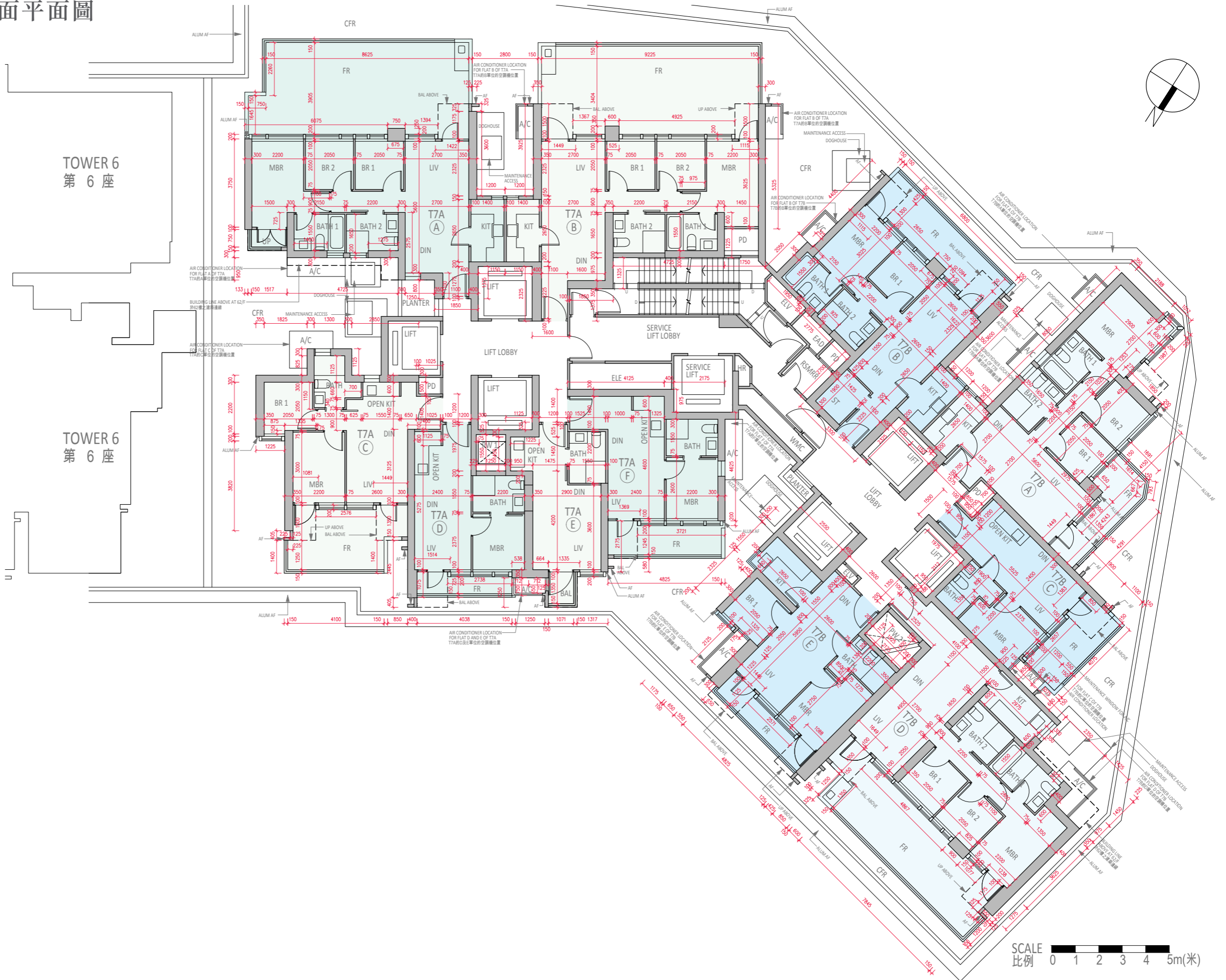

SCALE
比例 0 1 2 3 4 5m(米)

Floor plans of residential properties in the phase 期數的住宅物業的樓面平面圖

Tower 7 (7A & 7B) 8/F-12/F, 15/F-16/F, 18/F-23/F, 25/F-33/F, 35/F-39/F, 41/F-43/F, 45/F-53/F & 55/F-61/F (13/F, 14/F, 24/F, 34/F, 44/F and 54/F are omitted)
第7座 (7A及7B) 8樓至12樓, 15樓至16樓, 18樓至23樓, 25樓至33樓, 35樓至39樓, 41樓至43樓, 45樓至53樓及55樓至61樓 (不設13樓、14樓、24樓、34樓、44樓及54樓)

Description 描述	Floor 樓層	Tower 7 (7A) 第7座 (7A)						Tower 7 (7B) 第7座 (7B)				
		Flat 單位						Flat 單位				
		A	B	C	D	E	F	A	B	C	D	E
Floor-to-floor height (refers to the height between the top surface of the structural slab of a floor and the top surface of the structural slab of its immediate upper floor) of each residential property (m) 每個住宅物業的層與層之間的高度 (指該樓層之石屎地台面與上一層石屎地台面之高度距離) (米)	8/F-12/F, 15/F, 18/F-23/F, 25/F-33/F, 35/F-38/F, 41/F-43/F, 45/F-53/F & 55/F-60/F 8樓至12樓、15樓、18樓至23樓、25樓至33樓、35樓至38樓、41樓至43樓、45樓至53樓及55樓至60樓	3.035						3.035				
	16/F 16樓	3.035 3.135 3.335 3.385	3.035 3.135 3.285 3.335	3.035 3.135 3.285 3.360	3.035 3.385	3.035 3.135 3.335 3.360	3.035 3.135 3.235 3.335 3.485	3.035 3.135 3.335 3.385	3.035 3.135 3.135 3.360	3.035 3.135 3.335 3.385	3.035 3.135 3.335 3.360	
	39/F 39樓	3.035 3.135 3.335 3.385	3.035 3.135 3.285 3.335	3.035 3.135 3.285 3.360	3.035 3.385	3.035 3.135 3.335 3.360	3.035 3.135 3.235 3.335 3.485	3.035 3.135 3.335 3.385	3.035 3.110 3.210 3.360 3.435	3.035 3.135 3.335 3.385	3.035 3.135 3.335 3.360	
	61/F 61樓	3.040, 3.190 3.290, 3.340 3.390, 3.490 3.640, 3.740	3.040, 3.190 3.340, 3.390 3.490, 3.690 3.740	3.390			3.390		3.090, 3.265 3.290, 3.390 3.490, 3.640 3.690, 3.740	3.090, 3.210 3.390, 3.490 3.500, 3.715 3.800		
Thickness of the floor slabs (excluding plaster) of each residential property (mm) 每個住宅物業的樓板 (不包括灰泥) 厚度 (毫米)	8/F-12/F, 15/F, 18/F-23/F, 25/F-33/F, 35/F-38/F, 41/F-43/F, 45/F-53/F & 55/F-60/F 8樓至12樓、15樓、18樓至23樓、25樓至33樓、35樓至38樓、41樓至43樓、45樓至53樓及55樓至60樓	150 300	150	150 200 300	150 175 300	150	150 175	150	150 300	150 175	150 300	150 175 300
	16/F 16樓	150 300	150	150 200 300	150 175 300	150	150 175	150	150 300	150 175	150 300	150 175 300
	39/F 39樓	150 300	150	150 200 300	150 175 300	150	150 175	150	150 300	150 175 225 250	150 300	150 175 300
	61/F 61樓	150 300	150	150 200 300	150 175 300	150	150 175	150	150 300	150 175	150 300	150 200 300

The internal areas of the residential properties on the upper floors will generally be slightly larger than those on the lower floors because of the reducing thickness of the structural walls on the upper floors (Note: This statement as required under section 10(2)(e) of Part 1 of Schedule 1 to the Residential Properties (First-hand Sales) Ordinance is not applicable to the Phase).

因住宅物業的較高樓層的結構牆的厚度遞減，較高樓層的內部面積，一般比較低樓層的內部面積稍大(備註：此《一手住宅物業銷售條例》附表1第1部第10(2)(e)條規定之陳述並不適用於期數)。

Remarks :

- The dimensions in the floor plans are all structural dimensions in millimetre and rounded off to the nearest integer.
- For details of the noise mitigation measures, please refer to the Relevant Information section in this sales brochure.
- Please refer to Page 23 of this sales brochure for legend of the terms and abbreviations shown in the floor plan.

備註：

- 樓面平面圖之尺規所列數字為以毫米標示之建築結構尺寸，並以四捨五入至整數。
- 有關紓緩噪音措施之詳情，請參閱本售樓說明書的有關資料章節。
- 平面圖中顯示之名稱及簡稱之圖例請參閱本售樓說明書第23頁。

Floor plans of residential properties in the phase 期數的住宅物業的樓面平面圖

Tower 7 (7A & 7B)
8/F-12/F, 15/F-16/F,
18/F-23/F, 25/F-33/F,
35/F-39/F, 41/F-43/F,
45/F-53/F & 55/F-61/F
(13/F, 14/F, 24/F, 34/F, 44/F
and 54/F are omitted)

第7座 (7A及7B)
8樓至12樓, 15樓至16樓,
18樓至23樓, 25樓至33樓,
35樓至39樓, 41樓至43樓,
45樓至53樓及55樓至61樓
(不設13樓、14樓、24樓、
34樓、44樓及54樓)

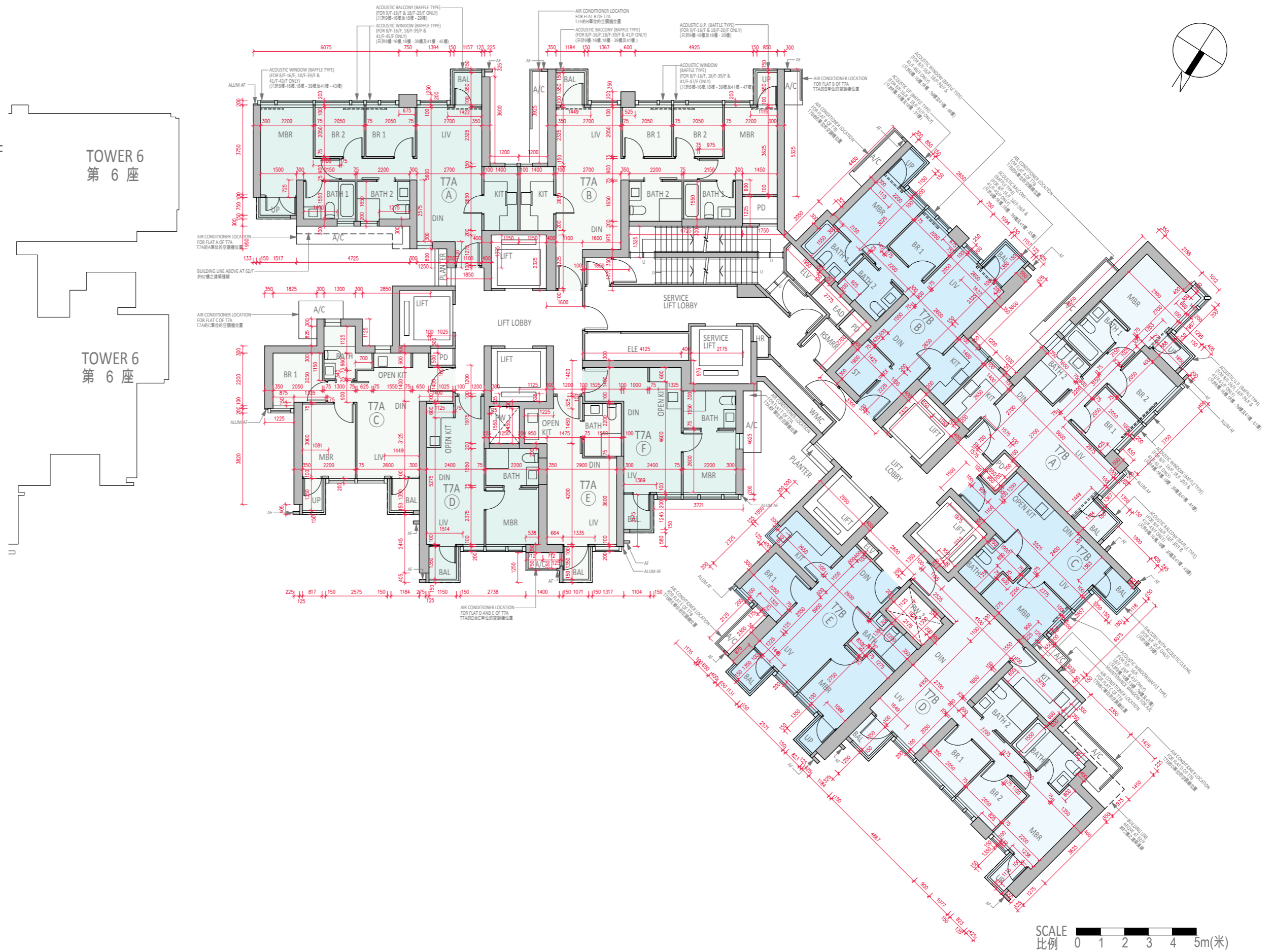

Floor plans of residential properties in the phase 期數的住宅物業的樓面平面圖

Tower 7 (7A & 7B) 62/F
第7座 (7A及7B) 62樓

Description 描述	Tower 7 (7A) 第7座 (7A)					Tower 7 (7B) 第7座 (7B)			
	Flat 單位					Flat 單位			
	A	C	D	E	F	A	B	C	D
Floor-to-floor height (refers to the height between the top surface of the structural slab of a floor and the top surface of the structural slab of its immediate upper floor) of each residential property (m) 每個住宅物業的層與層之間的高度 (指該樓層之石屎地台面與上一層石屎地台面之高度距離) (米)	3.500 3.600 3.700 3.850	3.500 3.600 3.750 3.800	3.500 3.600 3.750 3.825	3.500 3.850	3.500 3.600 3.825	3.500 3.600 3.800 3.850	3.500 3.600 3.600 3.825	3.500 3.600 3.800 3.825 3.850	3.500 3.600 3.625 3.800 3.825 3.850
Thickness of the floor slabs (excluding plaster) of each residential property (mm) 每個住宅物業的樓板 (不包括灰泥) 厚度 (毫米)	200 300	200 250 300	200	200	200	200	200 300	200	200 250 300

The internal areas of the residential properties on the upper floors will generally be slightly larger than those on the lower floors because of the reducing thickness of the structural walls on the upper floors (Note: This statement as required under section 10(2)(e) of Part 1 of Schedule 1 to the Residential Properties (First-hand Sales) Ordinance is not applicable to the Phase).

因住宅物業的較高樓層的結構牆的厚度遞減，較高樓層的內部面積，一般比較低樓層的內部面積稍大(備註：此《一手住宅物業銷售條例》附表1第1部第10(2)(e)條規定之陳述並不適用於期數)。

Remarks :

1. The dimensions in the floor plans are all structural dimensions in millimetre and rounded off to the nearest integer.
2. For details of the noise mitigation measures, please refer to the Relevant Information section in this sales brochure.
3. Please refer to Page 23 of this sales brochure for legend of the terms and abbreviations shown in the floor plan.

備註：

1. 樓面平面圖之尺規所列數字為以毫米標示之建築結構尺寸，並以四捨五入至整數。
2. 有關紓緩噪音措施之詳情，請參閱本售樓說明書的有關資料章節。
3. 平面圖中顯示之名詞及簡稱之圖例請參閱本售樓說明書第23頁。

Floor plans of residential properties in the phase 期數的住宅物業的樓面平面圖

Tower 7 (7A & 7B)
第7座 (7A及7B)

62/F
62樓

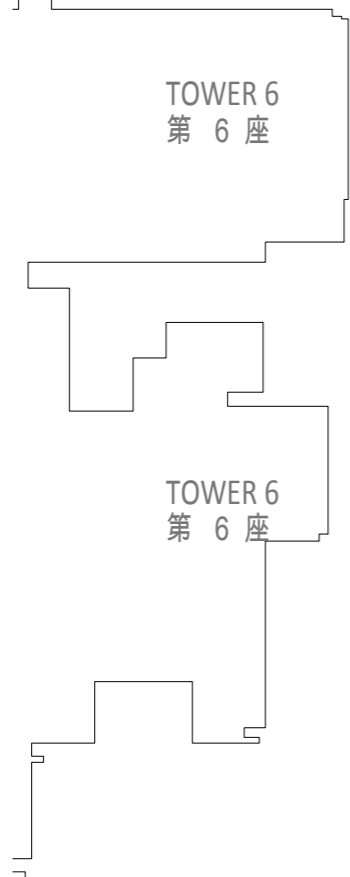

SCALE
比例 0 1 2 3 4 5m(米)

Floor plans of residential properties in the phase 期數的住宅物業的樓面平面圖

Tower 7 (7A & 7B) ROOF
第7座 (7A及7B) 天台

Description 描述	Tower 7 (7A) 第7座 (7A)					Tower 7 (7B) 第7座 (7B)			
	Flat 單位					Flat 單位			
	A	C	D	E	F	A	B	C	D
Floor-to-floor height (refers to the height between the top surface of the structural slab of a floor and the top surface of the structural slab of its immediate upper floor) of each residential property (m) 每個住宅物業的層與層之間的高度 (指該樓層之石屎地台面與上一層石屎地台面之高度距離) (米)	Not Applicable 不適用					Not Applicable 不適用			
Thickness of the floor slabs (excluding plaster) of each residential property (mm) 每個住宅物業的樓板 (不包括灰泥) 厚度 (毫米)	Not Applicable 不適用					Not Applicable 不適用			

The internal areas of the residential properties on the upper floors will generally be slightly larger than those on the lower floors because of the reducing thickness of the structural walls on the upper floors (Note: This statement as required under section 10(2)(e) of Part 1 of Schedule 1 to the Residential Properties (First-hand Sales) Ordinance is not applicable to the Phase).

因住宅物業的較高樓層的結構牆的厚度遞減，較高樓層的內部面積，一般比較低樓層的內部面積稍大(備註：此《一手住宅物業銷售條例》附表1第1部第10(2)(e)條規定之陳述並不適用於期數)。

Remarks :

1. The dimensions in the floor plans are all structural dimensions in millimetre and rounded off to the nearest integer.
2. For details of the noise mitigation measures, please refer to the Relevant Information section in this sales brochure.
3. Please refer to Page 23 of this sales brochure for legend of the terms and abbreviations shown in the floor plan.

備註：

1. 樓面平面圖之尺規所列數字為以毫米標示之建築結構尺寸，並以四捨五入至整數。
2. 有關紓緩噪音措施之詳情，請參閱本售樓說明書的有關資料章節。
3. 平面圖中顯示之名詞及簡稱之圖例請參閱本售樓說明書第23頁。

Floor plans of residential properties in the phase 期數的住宅物業的樓面平面圖

Tower 7 (7A & 7B)
第7座 (7A及7B)

ROOF
天台

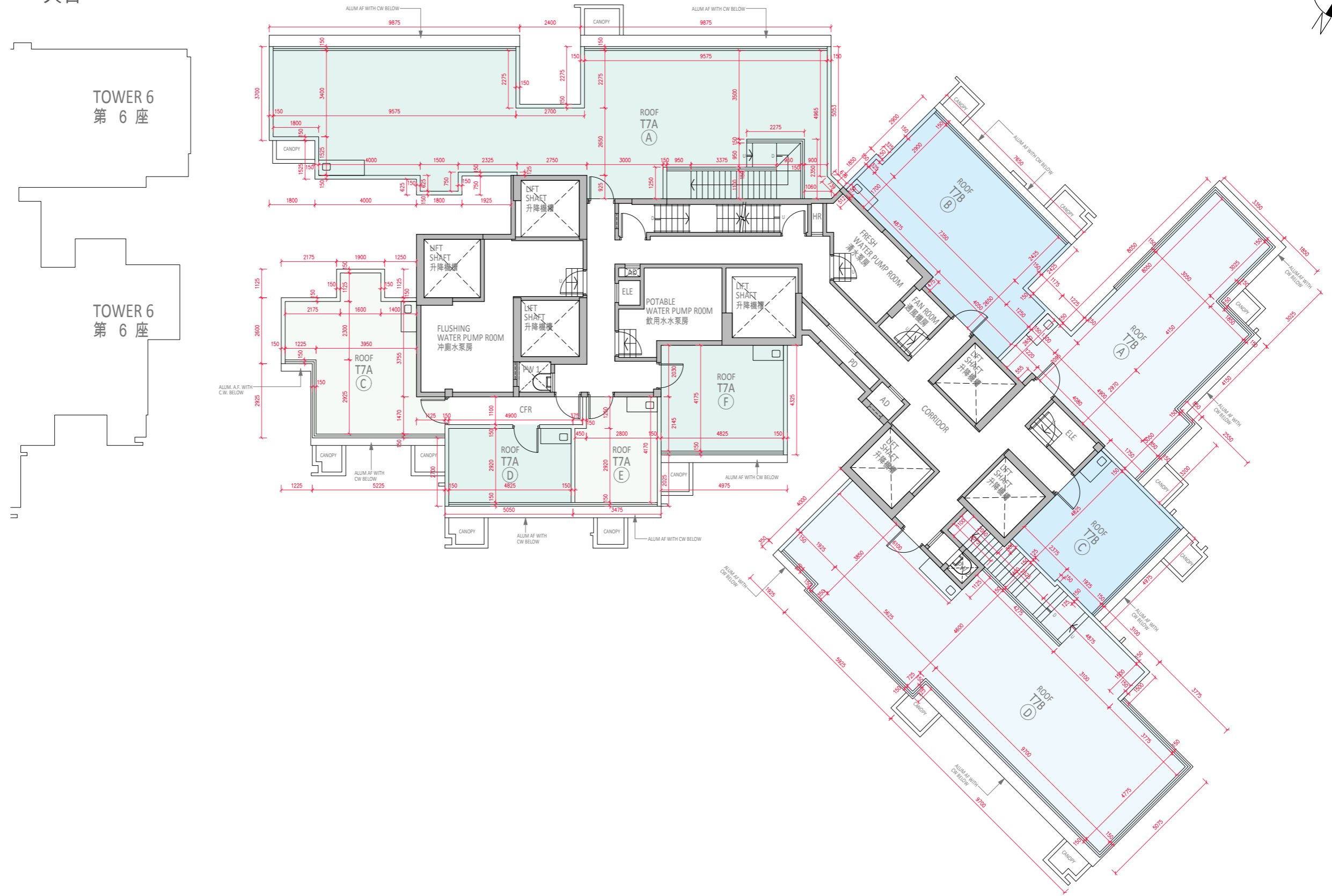
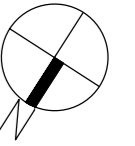

SCALE
比例 0 1 2 3 4 5m(米)

Area of residential properties in the phase 期數中的住宅物業的面積

Description of Residential Property 物業的描述			Saleable Area (including balcony, utility platform and verandah, if any) sq. metre (sq. ft.) 實用面積 (包括露台、工作平台及陽台 (如有)) 平方米 (平方呎)	Area of other specified items (Not included in the Saleable Area) sq. metre (sq. ft.) 其他指明項目的面積 (不計算入實用面積) 平方米 (平方呎)									
Tower Name 座數	Floor 樓層	Flat 單位		Air-conditioning plant room 空調機房	Bay window 窗台	Cockloft 閣樓	Flat roof 平台	Garden 花園	Parking space 停車位	Roof 天台	Stairhood 梯屋	Terrace 前庭	Yard 庭院
Tower 5 (5A) 第5座 (5A)	7/F 7樓	A	59.585 (641) Balcony 露台: - (-) Utility Platform 工作平台: - (-), Verandah 陽台: - (-)	-	-	-	26.956 (290)	-	-	-	-	-	-
		B	55.357 (596) Balcony 露台: - (-) Utility Platform 工作平台: - (-), Verandah 陽台: - (-)	-	-	-	16.703 (180)	-	-	-	-	-	-
		C	40.829 (439) Balcony 露台: - (-) Utility Platform 工作平台: - (-), Verandah 陽台: - (-)	-	-	-	4.478 (48)	-	-	-	-	-	-
		D	49.268 (530) Balcony 露台: - (-) Utility Platform 工作平台: - (-), Verandah 陽台: - (-)	-	-	-	11.307 (122)	-	-	-	-	-	-
		E	39.435 (424) Balcony 露台: - (-) Utility Platform 工作平台: - (-), Verandah 陽台: - (-)	-	-	-	14.000 (151)	-	-	-	-	-	-
Tower 5 (5B) 第5座 (5B)	7/F 7樓	A	58.557 (630) Balcony 露台: - (-) Utility Platform 工作平台: - (-), Verandah 陽台: - (-)	-	-	-	8.171 (88)	-	-	-	-	-	-
		B	59.347 (639) Balcony 露台: - (-) Utility Platform 工作平台: 1.500 (16), Verandah 陽台: - (-)	-	-	-	18.123 (195)	-	-	-	-	-	-
		C	49.990 (538) Balcony 露台: - (-) Utility Platform 工作平台: - (-), Verandah 陽台: - (-)	-	-	-	30.444 (328)	-	-	-	-	-	-
		D	44.875 (483) Balcony 露台: - (-) Utility Platform 工作平台: - (-), Verandah 陽台: - (-)	-	-	-	10.273 (111)	-	-	-	-	-	-

- The saleable area of the residential property is calculated in accordance with Section 8 of the Residential Properties (First-hand Sales) Ordinance.
- The floor area of every one of the balcony, utility platform and verandah, if any, to the extent that it forms part of the residential property is calculated in accordance with Section 8 of the Residential Properties (First-hand Sales) Ordinance.
- The areas of other specified items (not included in the saleable area) are calculated in accordance with Part 2 of Schedule 2 to the Residential Properties (First-hand Sales) Ordinance.

Remarks :

- The areas in square feet have been converted from square metres based on a conversion rate of 1 square metre = 10.764 square feet and rounded off to the nearest integer.
- 13/F, 14/F, 24/F, 34/F, 44/F and 54/F are omitted.

- 住宅物業的實用面積是按《一手住宅物業銷售條例》第8條計算得出的。
- 在構成住宅物業的一部分的範圍內的每一露台、工作平台及陽台(如有)之樓面面積是按《一手住宅物業銷售條例》第8條計算得出的。
- 其他指明項目的面積(不計算入實用面積)是按《一手住宅物業銷售條例》附表2第2部計算得出的。

備註 :

- 以平方呎列出的面積由以平方米列出的面積以1平方米=10.764平方呎換算，並以四捨五入至整數。
- 不設13樓、14樓、24樓、34樓、44樓及54樓。

Area of residential properties in the phase 期數中的住宅物業的面積

Description of Residential Property 物業的描述			Saleable Area (including balcony, utility platform and verandah, if any) sq. metre (sq. ft.) 實用面積 (包括露台、工作平台及陽台 (如有)) 平方米 (平方呎)	Area of other specified items (Not included in the Saleable Area) sq. metre (sq. ft.) 其他指明項目的面積 (不計算入實用面積) 平方米 (平方呎)									
Tower Name 座數	Floor 樓層	Flat 單位		Air-conditioning plant room 空調機房	Bay window 窗台	Cockloft 閣樓	Flat roof 平台	Garden 花園	Parking space 停車位	Roof 天台	Stairhood 梯屋	Terrace 前庭	Yard 庭院
Tower 5 (5A) 第5座 (5A)	8/F-12/F, 15/F-16/F, 18/F-23/F, 25/F-33/F, 35/F-39/F, 41/F-43/F, 45/F-53/F & 55/F-61/F 8樓至12樓、 15樓至16樓、 18樓至23樓、 25樓至33樓、 35樓至39樓、 41樓至43樓、 45樓至53樓及 55樓至61樓	A	63.085 (679) Balcony 露台: 2.000 (22) Utility Platform 工作平台: 1.500 (16), Verandah 陽台: - (-)	-	-	-	-	-	-	-	-	-	
		B	58.857 (634) Balcony 露台: 2.000 (22) Utility Platform 工作平台: 1.500 (16), Verandah 陽台: - (-)	-	-	-	-	-	-	-	-	-	-
		C	44.329 (477) Balcony 露台: 2.000 (22) Utility Platform 工作平台: 1.500 (16), Verandah 陽台: - (-)	-	-	-	-	-	-	-	-	-	-
		D	52.768 (568) Balcony 露台: 2.000 (22) Utility Platform 工作平台: 1.500 (16), Verandah 陽台: - (-)	-	-	-	-	-	-	-	-	-	-
		E	42.935 (462) Balcony 露台: 2.000 (22) Utility Platform 工作平台: 1.500 (16), Verandah 陽台: - (-)	-	-	-	-	-	-	-	-	-	-
Tower 5 (5B) 第5座 (5B)	8/F-12/F, 15/F-16/F, 18/F-23/F, 25/F-33/F, 35/F-39/F, 41/F-43/F, 45/F-53/F & 55/F-61/F 8樓至12樓、 15樓至16樓、 18樓至23樓、 25樓至33樓、 35樓至39樓、 41樓至43樓、 45樓至53樓及 55樓至61樓	A	62.057 (668) Balcony 露台: 2.000 (22) Utility Platform 工作平台: 1.500 (16), Verandah 陽台: - (-)	-	-	-	-	-	-	-	-	-	
		B	61.347 (660) Balcony 露台: 2.000 (22) Utility Platform 工作平台: 1.500 (16), Verandah 陽台: - (-)	-	-	-	-	-	-	-	-	-	
		C	53.490 (576) Balcony 露台: 2.000 (22) Utility Platform 工作平台: 1.500 (16), Verandah 陽台: - (-)	-	-	-	-	-	-	-	-	-	
		D	48.375 (521) Balcony 露台: 2.000 (22) Utility Platform 工作平台: 1.500 (16), Verandah 陽台: - (-)	-	-	-	-	-	-	-	-	-	

- The saleable area of the residential property is calculated in accordance with Section 8 of the Residential Properties (First-hand Sales) Ordinance.
- The floor area of every one of the balcony, utility platform and verandah, if any, to the extent that it forms part of the residential property is calculated in accordance with Section 8 of the Residential Properties (First-hand Sales) Ordinance.
- The areas of other specified items (not included in the saleable area) are calculated in accordance with Part 2 of Schedule 2 to the Residential Properties (First-hand Sales) Ordinance.

Remarks :

- The areas in square feet have been converted from square metres based on a conversion rate of 1 square metre = 10.764 square feet and rounded off to the nearest integer.
- 13/F, 14/F, 24/F, 34/F, 44/F and 54/F are omitted.

- 住宅物業的實用面積是按《一手住宅物業銷售條例》第8條計算得出的。
- 在構成住宅物業的一部分的範圍內的每一露台、工作平台及陽台(如有)之樓面面積是按《一手住宅物業銷售條例》第8條計算得出的。
- 其他指明項目的面積(不計算入實用面積)是按《一手住宅物業銷售條例》附表2第2部計算得出的。

備註:

- 以平方呎列出的面積由以平方米列出的面積以1平方米=10.764平方呎換算，並以四捨五入至整數。
- 不設13樓、14樓、24樓、34樓、44樓及54樓。

Area of residential properties in the phase 期數中的住宅物業的面積

Description of Residential Property 物業的描述			Saleable Area (including balcony, utility platform and verandah, if any) sq. metre (sq. ft.) 實用面積 (包括露台、工作平台及陽台 (如有)) 平方米 (平方呎)	Area of other specified items (Not included in the Saleable Area) sq. metre (sq. ft.) 其他指明項目的面積 (不計算入實用面積) 平方米 (平方呎)								
Tower Name 座數	Floor 樓層	Flat 單位		Air-conditioning plant room 空調機房	Bay window 窗台	Cockloft 閣樓	Flat roof 平台	Garden 花園	Parking space 停車位	Roof 天台	Stairhood 梯屋	Terrace 前庭
Tower 5 (5A) 第5座 (5A)	62/F 62樓	A	112.113 (1,207) Balcony 露台: 2.000 (22) Utility Platform 工作平台: 1.500 (16), Verandah 陽台: - (-)	-	-	-	-	-	90.025 (969)	-	-	-
		B	58.857 (634) Balcony 露台: 2.000 (22) Utility Platform 工作平台: 1.500 (16), Verandah 陽台: - (-)	-	-	-	-	-	33.566 (361)	-	-	-
		D	52.620 (566) Balcony 露台: 2.000 (22) Utility Platform 工作平台: 1.500 (16), Verandah 陽台: - (-)	-	-	-	-	-	31.533 (339)	-	-	-
		E	42.935 (462) Balcony 露台: 2.000 (22) Utility Platform 工作平台: 1.500 (16), Verandah 陽台: - (-)	-	-	-	-	-	26.032 (280)	-	-	-
Tower 5 (5B) 第5座 (5B)	62/F 62樓	A	121.203 (1,305) Balcony 露台: 2.353 (25) Utility Platform 工作平台: 1.500 (16), Verandah 陽台: - (-)	-	-	-	-	-	106.798 (1,150)	-	-	-
		C	53.490 (576) Balcony 露台: 2.000 (22) Utility Platform 工作平台: 1.500 (16), Verandah 陽台: - (-)	-	-	-	-	-	26.283 (283)	-	-	-
		D	48.375 (521) Balcony 露台: 2.000 (22) Utility Platform 工作平台: 1.500 (16), Verandah 陽台: - (-)	-	-	-	-	-	24.378 (262)	-	-	-

- The saleable area of the residential property is calculated in accordance with Section 8 of the Residential Properties (First-hand Sales) Ordinance.
- The floor area of every one of the balcony, utility platform and verandah, if any, to the extent that it forms part of the residential property is calculated in accordance with Section 8 of the Residential Properties (First-hand Sales) Ordinance.
- The areas of other specified items (not included in the saleable area) are calculated in accordance with Part 2 of Schedule 2 to the Residential Properties (First-hand Sales) Ordinance.

Remarks :

- The areas in square feet have been converted from square metres based on a conversion rate of 1 square metre = 10.764 square feet and rounded off to the nearest integer.
- 13/F, 14/F, 24/F, 34/F, 44/F and 54/F are omitted.

- 住宅物業的實用面積是按《一手住宅物業銷售條例》第8條計算得出的。
- 在構成住宅物業的一部分的範圍內的每一露台、工作平台及陽台(如有)之樓面面積是按《一手住宅物業銷售條例》第8條計算得出的。
- 其他指明項目的面積(不計算入實用面積)是按《一手住宅物業銷售條例》附表2第2部計算得出的。

備註 :

- 以平方呎列出的面積由以平方米列出的面積以1平方米=10.764平方呎換算，並以四捨五入至整數。
- 不設13樓、14樓、24樓、34樓、44樓及54樓。

Area of residential properties in the phase 期數中的住宅物業的面積

Description of Residential Property 物業的描述			Saleable Area (including balcony, utility platform and verandah, if any) sq. metre (sq. ft.) 實用面積 (包括露台、工作平台及陽台 (如有)) 平方米 (平方呎)	Area of other specified items (Not included in the Saleable Area) sq. metre (sq. ft.) 其他指明項目的面積 (不計算入實用面積) 平方米 (平方呎)									
Tower Name 座數	Floor 樓層	Flat 單位		Air-conditioning plant room 空調機房	Bay window 窗台	Cockloft 閣樓	Flat roof 平台	Garden 花園	Parking space 停車位	Roof 天台	Stairhood 梯屋	Terrace 前庭	Yard 庭院
Tower 6 (6A) 第6座 (6A)	7/F 7樓	A	60.121 (647) Balcony 露台: - (-) Utility Platform 工作平台: 1.500 (16), Verandah 陽台: - (-)	-	-	-	40.494 (436)	-	-	-	-	-	-
		B	55.223 (594) Balcony 露台: - (-) Utility Platform 工作平台: - (-), Verandah 陽台: - (-)	-	-	-	29.787 (321)	-	-	-	-	-	-
		C	38.484 (414) Balcony 露台: - (-) Utility Platform 工作平台: - (-), Verandah 陽台: - (-)	-	-	-	13.311 (143)	-	-	-	-	-	-
		D	38.441 (414) Balcony 露台: - (-) Utility Platform 工作平台: - (-), Verandah 陽台: - (-)	-	-	-	6.333 (68)	-	-	-	-	-	-
		E	41.792 (450) Balcony 露台: - (-) Utility Platform 工作平台: - (-), Verandah 陽台: - (-)	-	-	-	17.172 (185)	-	-	-	-	-	-
Tower 6 (6B) 第6座 (6B)	7/F 7樓	A	61.435 (661) Balcony 露台: - (-) Utility Platform 工作平台: 1.500 (16), Verandah 陽台: - (-)	-	-	-	22.590 (243)	-	-	-	-	-	-
		C	48.261 (519) Balcony 露台: - (-) Utility Platform 工作平台: - (-), Verandah 陽台: - (-)	-	-	-	15.641 (168)	-	-	-	-	-	-
		D	24.688 (266) Balcony 露台: 2.000 (22) Utility Platform 工作平台: - (-), Verandah 陽台: - (-)	-	-	-	-	-	-	-	-	-	-
		E	29.030 (312) Balcony 露台: - (-) Utility Platform 工作平台: - (-), Verandah 陽台: - (-)	-	-	-	3.391 (37)	-	-	-	-	-	-
		F	39.579 (426) Balcony 露台: - (-) Utility Platform 工作平台: - (-), Verandah 陽台: - (-)	-	-	-	13.846 (149)	-	-	-	-	-	-

- The saleable area of the residential property is calculated in accordance with Section 8 of the Residential Properties (First-hand Sales) Ordinance.
- The floor area of every one of the balcony, utility platform and verandah, if any, to the extent that it forms part of the residential property is calculated in accordance with Section 8 of the Residential Properties (First-hand Sales) Ordinance.
- The areas of other specified items (not included in the saleable area) are calculated in accordance with Part 2 of Schedule 2 to the Residential Properties (First-hand Sales) Ordinance.

Remarks :

- The areas in square feet have been converted from square metres based on a conversion rate of 1 square metre = 10.764 square feet and rounded off to the nearest integer.
- 13/F, 14/F, 24/F, 34/F, 44/F and 54/F are omitted.

- 住宅物業的實用面積是按《一手住宅物業銷售條例》第8條計算得出的。
- 在構成住宅物業的一部分的範圍內的每一露台、工作平台及陽台(如有)之樓面面積是按《一手住宅物業銷售條例》第8條計算得出的。
- 其他指明項目的面積(不計算入實用面積)是按《一手住宅物業銷售條例》附表2第2部計算得出的。

備註:

- 以平方呎列出的面積由以平方米列出的面積以1平方米=10.764平方呎換算，並以四捨五入至整數。
- 不設13樓、14樓、24樓、34樓、44樓及54樓。

Area of residential properties in the phase 期數中的住宅物業的面積

Description of Residential Property 物業的描述			Saleable Area (including balcony, utility platform and verandah, if any) sq. metre (sq. ft.) 實用面積 (包括露台、工作平台及陽台 (如有)) 平方米 (平方呎)	Area of other specified items (Not included in the Saleable Area) sq. metre (sq. ft.) 其他指明項目的面積 (不計算入實用面積) 平方米 (平方呎)									
Tower Name 座數	Floor 樓層	Flat 單位		Air-conditioning plant room 空調機房	Bay window 窗台	Cockloft 閣樓	Flat roof 平台	Garden 花園	Parking space 停車位	Roof 天台	Stairhood 梯屋	Terrace 前庭	Yard 庭院
Tower 6 (6A) 第6座 (6A)	8/F-12/F, 15/F-16/F, 18/F-23/F, 25/F-33/F & 35/F-39/F 8樓至12樓、 15樓至16樓、 18樓至23樓、 25樓至33樓及 35樓至39樓	A	62.121 (669) Balcony 露台: 2.000 (22) Utility Platform 工作平台: 1.500 (16), Verandah 陽台: - (-)	-	-	-	-	-	-	-	-	-	
		B	58.723 (632) Balcony 露台: 2.000 (22) Utility Platform 工作平台: 1.500 (16), Verandah 陽台: - (-)	-	-	-	-	-	-	-	-	-	
		C	45.242 (487) Balcony 露台: 2.000 (22) Utility Platform 工作平台: 1.500 (16), Verandah 陽台: - (-)	-	-	-	-	-	-	-	-	-	
		D	41.941 (451) Balcony 露台: 2.000 (22) Utility Platform 工作平台: 1.500 (16), Verandah 陽台: - (-)	-	-	-	-	-	-	-	-	-	
		E	45.292 (488) Balcony 露台: 2.000 (22) Utility Platform 工作平台: 1.500 (16), Verandah 陽台: - (-)	-	-	-	-	-	-	-	-	-	
Tower 6 (6B) 第6座 (6B)	8/F-12/F, 15/F-16/F, 18/F-23/F, 25/F-33/F & 35/F-39/F 8樓至12樓、 15樓至16樓、 18樓至23樓、 25樓至33樓及 35樓至39樓	A	63.435 (683) Balcony 露台: 2.000 (22) Utility Platform 工作平台: 1.500 (16), Verandah 陽台: - (-)	-	-	-	-	-	-	-	-	-	
		C	51.761 (557) Balcony 露台: 2.000 (22) Utility Platform 工作平台: 1.500 (16), Verandah 陽台: - (-)	-	-	-	-	-	-	-	-	-	
		D	24.688 (266) Balcony 露台: 2.000 (22) Utility Platform 工作平台: - (-), Verandah 陽台: - (-)	-	-	-	-	-	-	-	-	-	
		E	31.030 (334) Balcony 露台: 2.000 (22) Utility Platform 工作平台: - (-), Verandah 陽台: - (-)	-	-	-	-	-	-	-	-	-	
		F	43.079 (464) Balcony 露台: 2.000 (22) Utility Platform 工作平台: 1.500 (16), Verandah 陽台: - (-)	-	-	-	-	-	-	-	-	-	

- The saleable area of the residential property is calculated in accordance with Section 8 of the Residential Properties (First-hand Sales) Ordinance.
- The floor area of every one of the balcony, utility platform and verandah, if any, to the extent that it forms part of the residential property is calculated in accordance with Section 8 of the Residential Properties (First-hand Sales) Ordinance.
- The areas of other specified items (not included in the saleable area) are calculated in accordance with Part 2 of Schedule 2 to the Residential Properties (First-hand Sales) Ordinance.

Remarks :

- The areas in square feet have been converted from square metres based on a conversion rate of 1 square metre = 10.764 square feet and rounded off to the nearest integer.
- 13/F, 14/F, 24/F, 34/F, 44/F and 54/F are omitted.

- 住宅物業的實用面積是按《一手住宅物業銷售條例》第8條計算得出的。
- 在構成住宅物業的一部分的範圍內的每一露台、工作平台及陽台(如有)之樓面面積是按《一手住宅物業銷售條例》第8條計算得出的。
- 其他指明項目的面積(不計算入實用面積)是按《一手住宅物業銷售條例》附表2第2部計算得出的。

備註 :

- 以平方呎列出的面積由以平方米列出的面積以1平方米=10.764平方呎換算，並以四捨五入至整數。
- 不設13樓、14樓、24樓、34樓、44樓及54樓。

Area of residential properties in the phase 期數中的住宅物業的面積

Description of Residential Property 物業的描述			Saleable Area (including balcony, utility platform and verandah, if any) sq. metre (sq. ft.) 實用面積 (包括露台、工作平台及陽台 (如有)) 平方米 (平方呎)	Area of other specified items (Not included in the Saleable Area) sq. metre (sq. ft.) 其他指明項目的面積 (不計算入實用面積) 平方米 (平方呎)								
Tower Name 座數	Floor 樓層	Flat 單位		Air-conditioning plant room 空調機房	Bay window 窗台	Cockloft 閣樓	Flat roof 平台	Garden 花園	Parking space 停車位	Roof 天台	Stairhood 梯屋	Terrace 前庭
Tower 6 (6A) 第6座 (6A)	41/F-43/F, 45/F-53/F & 55/F-61/F 41樓至43樓、 45樓至53樓及 55樓至61樓	A	62.121 (669) Balcony 露台: 2.000 (22) Utility Platform 工作平台: 1.500 (16), Verandah 陽台: - (-)	-	-	-	-	-	-	-	-	-
		B	58.723 (632) Balcony 露台: 2.000 (22) Utility Platform 工作平台: 1.500 (16), Verandah 陽台: - (-)	-	-	-	-	-	-	-	-	-
		C	45.242 (487) Balcony 露台: 2.000 (22) Utility Platform 工作平台: 1.500 (16), Verandah 陽台: - (-)	-	-	-	-	-	-	-	-	-
		D	41.941 (451) Balcony 露台: 2.000 (22) Utility Platform 工作平台: 1.500 (16), Verandah 陽台: - (-)	-	-	-	-	-	-	-	-	-
		E	45.292 (488) Balcony 露台: 2.000 (22) Utility Platform 工作平台: 1.500 (16), Verandah 陽台: - (-)	-	-	-	-	-	-	-	-	-
Tower 6 (6B) 第6座 (6B)	41/F-43/F, 45/F-53/F & 55/F-61/F 41樓至43樓、 45樓至53樓及 55樓至61樓	A	63.435 (683) Balcony 露台: 2.000 (22) Utility Platform 工作平台: 1.500 (16), Verandah 陽台: - (-)	-	-	-	-	-	-	-	-	-
		C	80.421 (866) Balcony 露台: 2.000 (22) Utility Platform 工作平台: 1.500 (16), Verandah 陽台: - (-)	-	-	-	-	-	-	-	-	-
		E	31.013 (334) Balcony 露台: 2.000 (22) Utility Platform 工作平台: - (-), Verandah 陽台: - (-)	-	-	-	-	-	-	-	-	-
		F	43.079 (464) Balcony 露台: 2.000 (22) Utility Platform 工作平台: 1.500 (16), Verandah 陽台: - (-)	-	-	-	-	-	-	-	-	-

- The saleable area of the residential property is calculated in accordance with Section 8 of the Residential Properties (First-hand Sales) Ordinance.
- The floor area of every one of the balcony, utility platform and verandah, if any, to the extent that it forms part of the residential property is calculated in accordance with Section 8 of the Residential Properties (First-hand Sales) Ordinance.
- The areas of other specified items (not included in the saleable area) are calculated in accordance with Part 2 of Schedule 2 to the Residential Properties (First-hand Sales) Ordinance.

Remarks :

- The areas in square feet have been converted from square metres based on a conversion rate of 1 square metre = 10.764 square feet and rounded off to the nearest integer.
- 13/F, 14/F, 24/F, 34/F, 44/F and 54/F are omitted.

- 住宅物業的實用面積是按《一手住宅物業銷售條例》第8條計算得出的。
- 在構成住宅物業的一部分的範圍內的每一露台、工作平台及陽台(如有)之樓面面積是按《一手住宅物業銷售條例》第8條計算得出的。
- 其他指明項目的面積(不計算入實用面積)是按《一手住宅物業銷售條例》附表2第2部計算得出的。

備註 :

- 以平方呎列出的面積由以平方米列出的面積以1平方米=10.764平方呎換算，並以四捨五入至整數。
- 不設13樓、14樓、24樓、34樓、44樓及54樓。

Area of residential properties in the phase 期數中的住宅物業的面積

Description of Residential Property 物業的描述			Saleable Area (including balcony, utility platform and verandah, if any) sq. metre (sq. ft.) 實用面積 (包括露台、工作平台及陽台 (如有)) 平方米 (平方呎)	Area of other specified items (Not included in the Saleable Area) sq. metre (sq. ft.) 其他指明項目的面積 (不計算入實用面積) 平方米 (平方呎)								
Tower Name 座數	Floor 樓層	Flat 單位		Air-conditioning plant room 空調機房	Bay window 窗台	Cockloft 閣樓	Flat roof 平台	Garden 花園	Parking space 停車位	Roof 天台	Stairhood 梯屋	Terrace 前庭
Tower 6 (6A) 第6座 (6A)	62/F 62樓	A	119.724 (1,289) Balcony 露台: 2.863 (31) Utility Platform 工作平台: 1.500 (16), Verandah 陽台: - (-)	-	-	-	-	-	98.901 (1,065)	-	-	-
		C	45.194 (486) Balcony 露台: 2.000 (22) Utility Platform 工作平台: 1.500 (16), Verandah 陽台: - (-)	-	-	-	-	-	18.251 (196)	-	-	-
		D	41.941 (451) Balcony 露台: 2.000 (22) Utility Platform 工作平台: 1.500 (16), Verandah 陽台: - (-)	-	-	-	-	-	21.244 (229)	-	-	-
		E	45.292 (488) Balcony 露台: 2.000 (22) Utility Platform 工作平台: 1.500 (16), Verandah 陽台: - (-)	-	-	-	-	-	30.336 (327)	-	-	-
Tower 6 (6B) 第6座 (6B)	62/F 62樓	A	63.435 (683) Balcony 露台: 2.000 (22) Utility Platform 工作平台: 1.500 (16), Verandah 陽台: - (-)	-	-	-	-	-	47.819 (515)	-	-	-
		C	80.181 (863) Balcony 露台: 2.000 (22) Utility Platform 工作平台: 1.500 (16), Verandah 陽台: - (-)	-	-	-	-	-	44.263 (476)	-	-	-
		E	31.013 (334) Balcony 露台: 2.000 (22) Utility Platform 工作平台: - (-), Verandah 陽台: - (-)	-	-	-	-	-	20.070 (216)	-	-	-
		F	43.079 (464) Balcony 露台: 2.000 (22) Utility Platform 工作平台: 1.500 (16), Verandah 陽台: - (-)	-	-	-	-	-	25.559 (275)	-	-	-

- The saleable area of the residential property is calculated in accordance with Section 8 of the Residential Properties (First-hand Sales) Ordinance.
- The floor area of every one of the balcony, utility platform and verandah, if any, to the extent that it forms part of the residential property is calculated in accordance with Section 8 of the Residential Properties (First-hand Sales) Ordinance.
- The areas of other specified items (not included in the saleable area) are calculated in accordance with Part 2 of Schedule 2 to the Residential Properties (First-hand Sales) Ordinance.

Remarks :

- The areas in square feet have been converted from square metres based on a conversion rate of 1 square metre = 10.764 square feet and rounded off to the nearest integer.
- 13/F, 14/F, 24/F, 34/F, 44/F and 54/F are omitted.

- 住宅物業的實用面積是按《一手住宅物業銷售條例》第8條計算得出的。
- 在構成住宅物業的一部分的範圍內的每一露台、工作平台及陽台(如有)之樓面面積是按《一手住宅物業銷售條例》第8條計算得出的。
- 其他指明項目的面積(不計算入實用面積)是按《一手住宅物業銷售條例》附表2第2部計算得出的。

備註 :

- 以平方呎列出的面積由以平方米列出的面積以1平方米=10.764平方呎換算，並以四捨五入至整數。
- 不設13樓、14樓、24樓、34樓、44樓及54樓。

Area of residential properties in the phase 期數中的住宅物業的面積

Description of Residential Property 物業的描述			Saleable Area (including balcony, utility platform and verandah, if any) sq. metre (sq. ft.) 實用面積 (包括露台、工作平台及陽台 (如有)) 平方米 (平方呎)	Area of other specified items (Not included in the Saleable Area) sq. metre (sq. ft.) 其他指明項目的面積 (不計算入實用面積) 平方米 (平方呎)									
Tower Name 座數	Floor 樓層	Flat 單位		Air-conditioning plant room 空調機房	Bay window 窗台	Cockloft 閣樓	Flat roof 平台	Garden 花園	Parking space 停車位	Roof 天台	Stairhood 梯屋	Terrace 前庭	Yard 庭院
Tower 7 (7A) 第7座 (7A)	7/F 7樓	A	59.706 (643) Balcony 露台: - (-) Utility Platform 工作平台: 1.500 (16), Verandah 陽台: - (-)	-	-	-	33.496 (361)	-	-	-	-	-	-
		B	60.641 (653) Balcony 露台: - (-) Utility Platform 工作平台: - (-), Verandah 陽台: - (-)	-	-	-	33.339 (359)	-	-	-	-	-	-
		C	38.696 (417) Balcony 露台: - (-) Utility Platform 工作平台: - (-), Verandah 陽台: - (-)	-	-	-	10.810 (116)	-	-	-	-	-	-
		D	28.112 (303) Balcony 露台: - (-) Utility Platform 工作平台: - (-), Verandah 陽台: - (-)	-	-	-	2.680 (29)	-	-	-	-	-	-
		E	24.561 (264) Balcony 露台: 2.000 (22) Utility Platform 工作平台: - (-), Verandah 陽台: - (-)	-	-	-	-	-	-	-	-	-	-
		F	30.047 (323) Balcony 露台: - (-) Utility Platform 工作平台: - (-), Verandah 陽台: - (-)	-	-	-	5.617 (60)	-	-	-	-	-	-
Tower 7 (7B) 第7座 (7B)	7/F 7樓	A	58.794 (633) Balcony 露台: - (-) Utility Platform 工作平台: - (-), Verandah 陽台: - (-)	-	-	-	6.324 (68)	-	-	-	-	-	-
		B	53.810 (579) Balcony 露台: - (-) Utility Platform 工作平台: - (-), Verandah 陽台: - (-)	-	-	-	10.950 (118)	-	-	-	-	-	-
		C	28.626 (308) Balcony 露台: - (-) Utility Platform 工作平台: - (-), Verandah 陽台: - (-)	-	-	-	6.473 (70)	-	-	-	-	-	-
		D	66.434 (715) Balcony 露台: - (-) Utility Platform 工作平台: - (-), Verandah 陽台: - (-)	-	-	-	20.818 (224)	-	-	-	-	-	-
		E	42.985 (463) Balcony 露台: - (-) Utility Platform 工作平台: - (-), Verandah 陽台: - (-)	-	-	-	4.237 (46)	-	-	-	-	-	-

- The saleable area of the residential property is calculated in accordance with Section 8 of the Residential Properties (First-hand Sales) Ordinance.
- The floor area of every one of the balcony, utility platform and verandah, if any, to the extent that it forms part of the residential property is calculated in accordance with Section 8 of the Residential Properties (First-hand Sales) Ordinance.
- The areas of other specified items (not included in the saleable area) are calculated in accordance with Part 2 of Schedule 2 to the Residential Properties (First-hand Sales) Ordinance.

Remarks :

- The areas in square feet have been converted from square metres based on a conversion rate of 1 square metre = 10.764 square feet and rounded off to the nearest integer.
- 13/F, 14/F, 24/F, 34/F, 44/F and 54/F are omitted.

- 住宅物業的實用面積是按《一手住宅物業銷售條例》第8條計算得出的。
- 在構成住宅物業的一部分的範圍內的每一露台、工作平台及陽台(如有)之樓面面積是按《一手住宅物業銷售條例》第8條計算得出的。
- 其他指明項目的面積(不計算入實用面積)是按《一手住宅物業銷售條例》附表2第2部計算得出的。

備註 :

- 以平方呎列出的面積由以平方米列出的面積以1平方米=10.764平方呎換算，並以四捨五入至整數。
- 不設13樓、14樓、24樓、34樓、44樓及54樓。

Area of residential properties in the phase 期數中的住宅物業的面積

Description of Residential Property 物業的描述			Saleable Area (including balcony, utility platform and verandah, if any) sq. metre (sq. ft.) 實用面積 (包括露台、工作平台及陽台 (如有)) 平方米 (平方呎)	Area of other specified items (Not included in the Saleable Area) sq. metre (sq. ft.) 其他指明項目的面積 (不計算入實用面積) 平方米 (平方呎)									
Tower Name 座數	Floor 樓層	Flat 單位		Air-conditioning plant room 空調機房	Bay window 窗台	Cockloft 閣樓	Flat roof 平台	Garden 花園	Parking space 停車位	Roof 天台	Stairhood 梯屋	Terrace 前庭	Yard 庭院
Tower 7 (7A) 第7座 (7A)	8/F-12/F, 15/F-16/F, 18/F-23/F, 25/F-33/F, 35/F-39/F, 41/F-43/F, 45/F-53/F & 55/F-61/F 8樓至12樓、 15樓至16樓、 18樓至23樓、 25樓至33樓、 35樓至39樓、 41樓至43樓、 45樓至53樓及 55樓至61樓	A	61.706 (664) Balcony 露台: 2.000 (22) Utility Platform 工作平台: 1.500 (16), Verandah 陽台: - (-)	-	-	-	-	-	-	-	-	-	
		B	64.141 (690) Balcony 露台: 2.000 (22) Utility Platform 工作平台: 1.500 (16), Verandah 陽台: - (-)	-	-	-	-	-	-	-	-	-	-
		C	42.196 (454) Balcony 露台: 2.000 (22) Utility Platform 工作平台: 1.500 (16), Verandah 陽台: - (-)	-	-	-	-	-	-	-	-	-	-
		D	30.112 (324) Balcony 露台: 2.000 (22) Utility Platform 工作平台: - (-), Verandah 陽台: - (-)	-	-	-	-	-	-	-	-	-	-
		E	24.561 (264) Balcony 露台: 2.000 (22) Utility Platform 工作平台: - (-), Verandah 陽台: - (-)	-	-	-	-	-	-	-	-	-	-
		F	32.047 (345) Balcony 露台: 2.000 (22) Utility Platform 工作平台: - (-), Verandah 陽台: - (-)	-	-	-	-	-	-	-	-	-	-
Tower 7 (7B) 第7座 (7B)	8/F-12/F, 15/F-16/F, 18/F-23/F, 25/F-33/F, 35/F-39/F, 41/F-43/F, 45/F-53/F & 55/F-61/F 8樓至12樓、 15樓至16樓、 18樓至23樓、 25樓至33樓、 35樓至39樓、 41樓至43樓、 45樓至53樓及 55樓至61樓	A	62.294 (671) Balcony 露台: 2.000 (22) Utility Platform 工作平台: 1.500 (16), Verandah 陽台: - (-)	-	-	-	-	-	-	-	-	-	
		B	57.310 (617) Balcony 露台: 2.000 (22) Utility Platform 工作平台: 1.500 (16), Verandah 陽台: - (-)	-	-	-	-	-	-	-	-	-	-
		C	30.626 (330) Balcony 露台: 2.000 (22) Utility Platform 工作平台: - (-), Verandah 陽台: - (-)	-	-	-	-	-	-	-	-	-	-
		D	69.934 (753) Balcony 露台: 2.000 (22) Utility Platform 工作平台: 1.500 (16), Verandah 陽台: - (-)	-	-	-	-	-	-	-	-	-	-
		E	46.485 (500) Balcony 露台: 2.000 (22) Utility Platform 工作平台: 1.500 (16), Verandah 陽台: - (-)	-	-	-	-	-	-	-	-	-	-

- The saleable area of the residential property is calculated in accordance with Section 8 of the Residential Properties (First-hand Sales) Ordinance.
- The floor area of every one of the balcony, utility platform and verandah, if any, to the extent that it forms part of the residential property is calculated in accordance with Section 8 of the Residential Properties (First-hand Sales) Ordinance.
- The areas of other specified items (not included in the saleable area) are calculated in accordance with Part 2 of Schedule 2 to the Residential Properties (First-hand Sales) Ordinance.

Remarks :

- The areas in square feet have been converted from square metres based on a conversion rate of 1 square metre = 10.764 square feet and rounded off to the nearest integer.
- 13/F, 14/F, 24/F, 34/F, 44/F and 54/F are omitted.

- 住宅物業的實用面積是按《一手住宅物業銷售條例》第8條計算得出的。
- 在構成住宅物業的一部分的範圍內的每一露台、工作平台及陽台(如有)之樓面面積是按《一手住宅物業銷售條例》第8條計算得出的。
- 其他指明項目的面積(不計算入實用面積)是按《一手住宅物業銷售條例》附表2第2部計算得出的。

備註 :

- 以平方呎列出的面積由以平方米列出的面積以1平方米=10.764平方呎換算，並以四捨五入至整數。
- 不設13樓、14樓、24樓、34樓、44樓及54樓。

Area of residential properties in the phase 期數中的住宅物業的面積

Description of Residential Property 物業的描述			Saleable Area (including balcony, utility platform and verandah, if any) sq. metre (sq. ft.) 實用面積 (包括露台、工作平台及陽台 (如有)) 平方米 (平方呎)	Area of other specified items (Not included in the Saleable Area) sq. metre (sq. ft.) 其他指明項目的面積 (不計算入實用面積) 平方米 (平方呎)									
Tower Name 座數	Floor 樓層	Flat 單位		Air-conditioning plant room 空調機房	Bay window 窗台	Cockloft 閣樓	Flat roof 平台	Garden 花園	Parking space 停車位	Roof 天台	Stairhood 梯屋	Terrace 前庭	Yard 庭院
Tower 7 (7A) 第7座 (7A)	62/F 62樓	A	122.854 (1,322) Balcony 露台: 2.526 (27) Utility Platform 工作平台: 1.500 (16), Verandah 陽台: - (-)	-	-	-	-	-	103.769 (1,117)	-	-	-	
		C	42.196 (454) Balcony 露台: 2.000 (22) Utility Platform 工作平台: 1.500 (16), Verandah 陽台: - (-)	-	-	-	-	-	25.035 (269)	-	-	-	
		D	30.112 (324) Balcony 露台: 2.000 (22) Utility Platform 工作平台: - (-), Verandah 陽台: - (-)	-	-	-	-	-	12.950 (139)	-	-	-	
		E	24.561 (264) Balcony 露台: 2.000 (22) Utility Platform 工作平台: - (-), Verandah 陽台: - (-)	-	-	-	-	-	11.899 (128)	-	-	-	
		F	32.047 (345) Balcony 露台: 2.000 (22) Utility Platform 工作平台: - (-), Verandah 陽台: - (-)	-	-	-	-	-	18.817 (203)	-	-	-	
Tower 7 (7B) 第7座 (7B)	62/F 62樓	A	62.294 (671) Balcony 露台: 2.000 (22) Utility Platform 工作平台: 1.500 (16), Verandah 陽台: - (-)	-	-	-	-	-	47.527 (512)	-	-	-	
		B	57.310 (617) Balcony 露台: 2.000 (22) Utility Platform 工作平台: 1.500 (16), Verandah 陽台: - (-)	-	-	-	-	-	36.927 (397)	-	-	-	
		C	30.582 (329) Balcony 露台: 2.000 (22) Utility Platform 工作平台: - (-), Verandah 陽台: - (-)	-	-	-	-	-	19.679 (212)	-	-	-	
		D	112.716 (1,213) Balcony 露台: 2.278 (25) Utility Platform 工作平台: 1.500 (16), Verandah 陽台: - (-)	-	-	-	3.780 (41)	-	-	88.352 (951)	-	-	-

- The saleable area of the residential property is calculated in accordance with Section 8 of the Residential Properties (First-hand Sales) Ordinance.
- The floor area of every one of the balcony, utility platform and verandah, if any, to the extent that it forms part of the residential property is calculated in accordance with Section 8 of the Residential Properties (First-hand Sales) Ordinance.
- The areas of other specified items (not included in the saleable area) are calculated in accordance with Part 2 of Schedule 2 to the Residential Properties (First-hand Sales) Ordinance.

Remarks :

- The areas in square feet have been converted from square metres based on a conversion rate of 1 square metre = 10.764 square feet and rounded off to the nearest integer.
- 13/F, 14/F, 24/F, 34/F, 44/F and 54/F are omitted.

- 住宅物業的實用面積是按《一手住宅物業銷售條例》第8條計算得出的。
- 在構成住宅物業的一部分的範圍內的每一露台、工作平台及陽台(如有)之樓面面積是按《一手住宅物業銷售條例》第8條計算得出的。
- 其他指明項目的面積(不計算入實用面積)是按《一手住宅物業銷售條例》附表2第2部計算得出的。



備註 :

- 以平方呎列出的面積由以平方米列出的面積以1平方米=10.764平方呎換算，並以四捨五入至整數。
- 不設13樓、14樓、24樓、34樓、44樓及54樓。

Floor plans of parking spaces in the phase 期數中的停車位的樓面平面圖

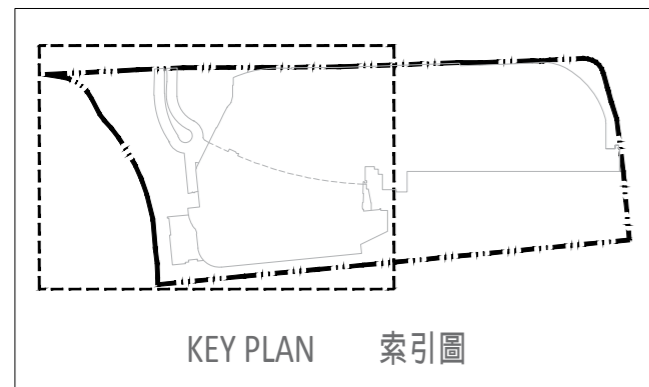
G/F Part Plan
地下部分平面圖



-  Loading & Unloading Space
上落貨停車位
-  Boundary Line of the Development
發展項目的界線

SCALE 比例 0 10 20 30 40 50m(米)

Floor plans of parking spaces in the phase 期數中的停車位的樓面平面圖

B1/F Part Plan
地庫1樓部分平面圖

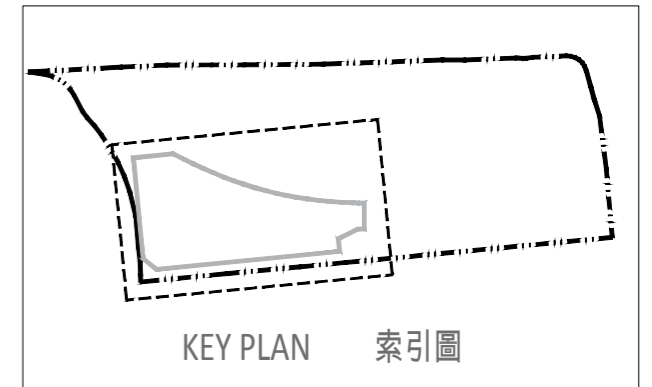
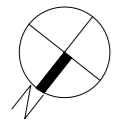

- Residential Car Parking Space
住宅私家車停車位
- Boundary Line of the Development
發展項目的界線

SCALE 比例 0 5 10 15 20 25m(米)

Floor plans of parking spaces in the phase 期數中的停車位的樓面平面圖

B2/F Part Plan
地庫2樓部分平面圖



	Residential Car Parking Space 住宅私家車停車位		Visitors' Parking Space 訪客停車位		Bicycle Parking Space 自行車停車位		Residential Motor Cycle Parking Space 住宅電單車停車位
 Boundary Line of the Development 發展項目的界線							
SCALE 比例 0 5 10 15 20 25m(米)							

Floor plans of parking spaces in the phase 期數中的停車位的樓面平面圖

B3/F Part Plan
地庫3樓部分平面圖



Residential Motor Cycle Parking Space
住宅電單車停車位

Visitors' Parking Space
訪客停車位

Bicycle Parking Space
自行車停車位

Boundary Line of the Development
發展項目的界線

SCALE
比例 0 5 10 15 20 25m(米)

Floor plans of parking spaces in the phase 期數中的停車位的樓面平面圖

Number, Dimensions and Areas of Parking Spaces 停車位的數目、尺寸及面積

Category of Parking Space 停車位類別	Number 數目				Parking Space Number 停車位編號				Dimensions (Length x Width) (m.) 尺寸 (長x闊) (米)	Area of each Parking Space (sq. m.) 每個停車位 面積 (平方米)
	G/F 地下	B1/F 地庫1樓	B2/F 地庫2樓	B3/F 地庫3樓	G/F 地下	B1/F 地庫1樓	B2/F 地庫2樓	B3/F 地庫3樓		
Residential Car Parking Space 住宅私家車停車位	-	29	177	-	-	B1-R167 - B1-R180; B1-R200 - B1-R203; B1-R232 - B1-R242	B2-R001 - B2-R093; B2-R100 - B2-R137; B2-R165 - B2-R180; B2-R197 - B2-R203; B2-R205 - B2-R227	-	5.0 x 2.5	12.50
Residential Motor Cycle Parking Space 住宅電單車停車位	-	-	20	4	-	-	B2-M01 - B2-M13; B2-M18 - B2-M24	B3-M24 - B3-M27	2.4 x 1.0	2.40
Visitors' Parking Space 訪客停車位	-	-	5	10	-	-	B2-V001 - B2-V005	B3-V011 - B3-V020	5.0 x 2.5	12.50
Bicycle Parking Space 自行車停車位	-	-	28	23	-	-	B2-B01 - B2-B28	B3-B12; B3-B28 - B3-B49	1.8 x 0.6	1.08
Loading & Unloading Space 上落貨停車位	3	-	-	-	L04, L07-L08	-	-	-	11.0 x 3.5	38.50

Summary of preliminary agreement for sale and purchase

臨時買賣合約的摘要

1. A preliminary deposit of 5% is payable on the signing of the preliminary agreement for sale and purchase.
 2. The preliminary deposit paid by the purchaser on the signing of that preliminary agreement will be held by a firm of solicitors acting for the owner, as stakeholders.
 3. If the purchaser fails to execute the agreement for sale and purchase within 5 working days after the date on which the purchaser enters into that preliminary agreement -
 - (a) that preliminary agreement is terminated;
 - (b) the preliminary deposit is forfeited; and
 - (c) the owner does not have any further claim against the purchaser for the failure.
1. 在簽署臨時買賣合約時須支付款額為5%的臨時訂金。
 2. 買方在簽署該臨時合約時支付的臨時訂金，會由代表擁有人行事的律師事務所以保證金保存人的身分持有。
 3. 如買方沒有於訂立該臨時合約的日期之後的5個工作日內簽立買賣合約 -
 - (a) 該臨時合約即告終止；
 - (b) 有關的臨時訂金即予沒收；及
 - (c) 擁有人不得就買方沒有簽立買賣合約而針對買方提出進一步申索。

Summary of deed of mutual covenant

公契的摘要

A. Summary of the provisions of the draft Principal Deed of Mutual Covenant and Management Agreement (“the PDMC”) that deal with the common parts of the Phase

1. “Common Areas” means the Estate Common Areas, the Residential Common Areas, the Residential Car Park Common Areas and the B3 Commercial Car Park Common Areas and those parts of the Estate as are designated as common areas in, and more particularly identified on plans to be annexed to, any Sub-Deed of Mutual Covenant or Deed Poll to be executed by the First Owner (excluding its successors and assigns) pursuant to the PDMC but excluding those parts of the Residential Development or the Residential Car Park which belong to the Owner of any particular Unit or which serve only any particular Unit and excluding all parts of the Commercial Development.
2. “Common Services and Facilities” means the Estate Common Services and Facilities, the Residential Common Services and Facilities, the Residential Car Park Common Services and Facilities and the B3 Commercial Car Park Common Services and Facilities and those services and facilities of the Estate as are designated as common services and facilities in any Sub-Deed of Mutual Covenant or Deed Poll to be executed by the First Owner (excluding its successors and assigns) pursuant to the PDMC excluding those services and facilities which belong to the Owner of any particular Unit or which serve only any particular Unit and excluding those services and facilities serving the Commercial Development or any part thereof.
3. “Estate Common Areas” means those parts of the Estate which are intended for use by Owners of the Estate as a whole and not for the sole benefit of any Owner or group of Owners of the Estate including, but not limited to all those parts of the Greenery Areas which serve the Estate as a whole, all the slabs of the said parts of the Estate above the upper boundary of the Tai Wai Station including all the slabs above the water-proofing membrane and system and associated protection immediately above, all utilities, services, trenches, pits and facilities which serve the Estate, as well as all the finishes of the Estate, parts of the Setting-back Area, part of the 24-hour Walkway, parts of the Pedestrian Link, the Drainage Reserve or the New Drainage Reserve (as the case may be), the Waterworks Reserve, driveways, lifts, run in and out, the Public Lay-By, the PSC Lay-Bys, the Existing Public Toilet Items, the PSC Items, the PTI Items, cavity walls and diaphragm walls of the Basement Level 4 to the Basement Level 1, external walls, finishes and architectural features below the ceiling of 3rd Floor (excluding those parts of external walls forming parts of the Commercial Development and the finishes and architectural features thereof and thereat), external walls of the drum ramp above the ceiling level of 6th Floor up to the roof level, ramps, lift shafts, shuttle lifts, footpaths, staircases, landings, corridors and passages; pump rooms, transformer room, main switch room, electricity rooms, fire services control room, master meter cabinet and water meter room, fuel tank rooms, street fire hydrant and sprinkler and fire services pump room, fan rooms, sprinkler control valve room, pipe ducts, emergency generator rooms, air duct shaft, refuse storage and material recovery

chamber; refuse collection point and spaces for the parking, loading and unloading of refuse collection vehicles provided pursuant to Special Condition No.(52)(b)(i) of the Government Grant; parapet walls, structural walls and columns, the foundations and other structural elements of the buildings erected on the Estate; management office, security room, guard rooms, caretaker's quarters, office for Owners Committee and/or Owners Corporation, stores, lavatories and any other space on or in the Estate used for office of caretaker(s) or other accommodation of the Owners Committee or the Owners Corporation and all other communal areas within the Estate not used for the sole benefit of any Owner or group of Owners of the Estate (but excluding all parts of the Commercial Development, the Residential Common Areas, the Residential Car Park Common Areas, the B3 Commercial Car Park Common Areas and those areas forming parts of other common areas as designated or to be designated in the Sub-Deed of Mutual Covenant or Deed Poll to be executed by the First Owner pursuant to the PDMC). The Estate Common Areas in Phase 1 and Phase 2 are for the purpose of identification only as shown (where possible and capable of being shown) coloured green, green hatched black and green cross-hatched black on the plans annexed to the PDMC and as shown (where possible and capable of being shown) coloured green, green hatched black and green cross-hatched black (for those parts within Phase 1) and coloured green dash hatched red (for those parts within Phase 2) on the Common Areas demarcation plans annexed to the PDMC. The Estate Common Areas in other Phase(s) shall be identified on plans to be annexed to any Sub-Deed of Mutual Covenant or Deed Poll to be executed in respect of such other Phases.

4. “Estate Common Services and Facilities” means those services and facilities constructed or to be constructed in on or under the Development and which serve the Estate as a whole and not for the sole benefit of any Owner or group of Owners of the Estate including, but not limited to, sewers, gutters, drains, watercourses, pipes and ducts; pumps, tanks and sanitary fittings; wires, cables, electrical installations, fittings, equipment and apparatus; fire alarm, fire protection and firefighting systems, equipment and apparatus; street fire hydrant water tank, fire services tank, sprinkler water tank, security systems, equipment and apparatus; refuse disposal equipment; ventilation and air-conditioning plant and equipment; air conditioners and fans and any other installations, systems, plant, equipment, apparatus, fittings, services and facilities used or installed in or for the common use and benefit of the Estate as part of the amenities thereof and not for the sole benefit of any Owner or group of Owners of the Estate, the Existing Public Toilet Items, the PSC Items and the PTI Items (but excluding all parts of the Commercial Development, the Residential Common Services and Facilities, the Residential Car Park Common Services and Facilities, the B3 Commercial Car Park Common Services and Facilities and those services and facilities forming parts of other common services and facilities designated or to be designated in the Sub-Deed of Mutual Covenant or Deed Poll to be executed by the First Owner pursuant to the PDMC).

Summary of deed of mutual covenant

公契的摘要

5. "Residential Common Areas" means those parts of the Residential Development intended for the common use and benefit of the Owners of the Residential Development and not for the sole benefit of any Owner of a Residential Unit, including but not limited to the transfer plates, parts of Pedestrian Link, the covered walkway with greenery on the top, all those parts of the Greenery Areas which serve the Residential Development as a whole and all the slabs of the said parts of the Residential Development above the upper boundary of the Tai Wai Station including all the slabs above the water-proofing membrane and system and associated protection immediately above, and all utilities, services, trenches, pits and facilities which serve the Residential Development or any part thereof, as well as all the finishes of the Residential Development, areas for accommodating electrical and mechanical installations above the roof of the Tai Wai Station on 4th Floor and below 5th Floor, inaccessible void above the roof of 5th Floor and below 6th Floor, emergency vehicular access, driveways, areas for installation or use of aerial broadcast distribution or telecommunications network facilities, satellite master antenna television (SMATV) room, residential entrance lobbies, residential shuttle lift lobbies, lift machine room, staircases, landings, walkways, corridors and passages, refuge floors, landscaped areas, communal podium gardens and acoustic fins, lift shafts, plant and equipment rooms podium deck, refuse rooms, swimming pool filtration plant rooms, flushing tank room, potable and cleansing tank room, roofs and flat roofs, air-conditioner platforms (including any grilles attached thereto), architectural features of the Towers and associated supporting beams and columns, the external walls of the Towers (including curtain walls or any part thereof (including the window frames, glass panels, hinges, locks, handles, cast-in anchors, gasket, window sealant and such other components of the curtain wall, the non-openable windows therein or thereto and window frames, glass panels, cast-in anchors, gasket, window sealant and such other components of such non-openable windows but excluding all openable windows installed therein and the frames enclosing the glass panels of the openable windows, glass panels, hinges, locks, handles, cast-in anchors, gasket, window sealant and such other components of such openable windows), non-structural prefabricated external wall, parapet walls, structural walls and columns within or appertaining to the Residential Development, the loading and unloading spaces for goods vehicles provided pursuant to Special Condition No.(44)(a)(i) of the Government Grant, Visitors' Parking Spaces, Bicycle Parking Spaces, caretaker's counters, Private Recreational Areas and Facilities, play areas, fire services pump rooms, transformer rooms, switch rooms, main telecommunication broadcast equipment rooms, telecommunication duct, emergency generator rooms, water pump rooms, fan rooms, water meter cabinet room, air handling unit rooms, filtration plant rooms, pipe ducts, cable ducts, air duct shaft, mail boxes, skylight, canopy, lawns, water features, planters, footpaths, Open Space, other open spaces, Noise Mitigation Measures (excluding those forming part or parts of a Unit) and other areas designated for the benefit of the Residential Development but excluding anything contained in the B3 Commercial Car Park Common Areas, the Estate Common Areas and the Residential Car Park Common Areas. The Residential Common Areas in Phase 1 and Phase 2 are for the purpose of identification only as shown (where possible or capable of being shown) coloured yellow and yellow stippled black on the plans annexed to the PDMC and as shown (where possible and capable of being shown) coloured yellow and yellow stippled black (for those parts within Phase 1) and coloured yellow dash hatched red and yellow stippled black dash hatched red (for those parts within Phase 2) on the Common Areas demarcation plans annexed to the PDMC. The Residential Common Areas in other Phase(s) shall be identified on plans to be annexed to any Sub-Deed of Mutual Covenant or Deed Poll to be executed in respect of such other Phases.
6. "Residential Common Services and Facilities" means those services and facilities constructed or installed or to be constructed or installed in on or under the Development and which serve the Residential Development and not for the sole benefit of any Owner of a Residential Unit including but not limited to, EV Facilities for Visitors' Parking Spaces, aerial broadcast distribution or telecommunication network facilities, drains, channels, water tanks, ducting, pipes, cables, wiring, plant and machinery, air-conditioning and ventilation system, electrical installations, fittings, equipment and apparatus, lifts, fire fighting installations and equipment, security systems and apparatus and gondolas but excluding anything contained in the B3 Commercial Car Park Common Services and Facilities, the Estate Common Services and Facilities and the Residential Car Park Common Services and Facilities.
7. "Residential Car Park Common Areas" means those parts of the Residential Car Park intended for the common use and benefit of the Owners, occupiers and licensees of (i) the Residential Parking Spaces, (ii) the Visitors' Parking Spaces and (iii) the Bicycle Parking Spaces including, but not limited to, finishes of the internal surface of enclosing walls of the Residential Car Park, all accessory areas, circulation passages, staircases, landings, drop off area, ramps, driveways, fan rooms, air duct shaft, fire service water tanks, pump room, carpark lift lobbies and EV charger rooms but excluding anything contained in the B3 Commercial Car Park Common Areas, the Estate Common Areas and the Residential Common Areas. The Residential Car Park Common Areas in Phase 1 and Phase 2 are for the purpose of identification only as shown (where possible and capable of being shown) coloured brown on the plans annexed to the PDMC and as shown (where possible and capable of being shown) coloured brown (for those parts within Phase 1) and coloured brown dash hatched red (for those parts within Phase 2) on the Common Areas demarcation plans annexed to the PDMC. The Residential Car Park Common Areas in other Phase(s) shall be identified on plans to be annexed to any Sub-Deed of Mutual Covenant or Deed Poll to be executed in respect of such other Phases.
8. "Residential Car Park Common Services and Facilities" means those services and facilities in on or under the Residential Car Park and which serve the Residential Parking Spaces including, but not limited to, plant and machinery, electrical and mechanical ventilation installations, fittings and equipment, water supply apparatus, drains, channels, control gates, smoke vent, firefighting installation and equipment, security systems and apparatus and the Common EV Facilities but excluding anything contained in the B3 Commercial Car Park Common Services and Facilities, the Estate Common Services and Facilities and the Residential Common Services and Facilities.
9. "B3 Commercial Car Park Common Areas" means those parts of driveways and circulation areas on Basement Level 3 intended for the common use and benefit of the Owners, occupiers and licensees of the B3 Commercial Car Parking Spaces and their bona fide guests, visitors or invitees which are for the purpose of identification only as shown (where possible and capable of being shown) coloured light brown on the Basement Level 3 Floor Plan annexed to the PDMC.
10. "B3 Commercial Car Park Common Services and Facilities" means those services and facilities which serve the B3 Commercial Car Parking Spaces including, but not limited to, plant and machinery, electrical and mechanical ventilation installations, fittings and equipment, water supply apparatus, drains, channels, control gates, smoke vent, firefighting installation and equipment, security systems and apparatus.

Summary of deed of mutual covenant

公契的摘要

11. Subject to the Building Management Ordinance and the provisions of the PDMC, the Common Areas and the Common Services and Facilities shall be under the exclusive control of the Manager. The Manager shall have the powers and duties to maintain and keep in good repair and condition the Common Areas and the Common Services and Facilities in accordance with the provisions of the PDMC. In the exercise of the aforesaid right contained in Clause 11(a) of Section C of the PDMC the Owner of the Commercial Development shall in respect of the B3 Commercial Car Park Common Areas and the B3 Commercial Car Park Common Services and Facilities comply with the obligations contained in Clause 1(b) of Section I of the PDMC and shall maintain a standard of management equivalent to the remainder of the Estate. The aforesaid right shall only survive for so long as the Commercial Development is solely owned by one Owner. Upon the Commercial Development falling into multi-ownership, the management of the B3 Commercial Car Park Common Areas and the B3 Commercial Car Park Common Services and Facilities shall revert to the Manager.
 12. If any Owner solely owns the whole of the Commercial Development, then that Owner may at its option exercise a right to manage the B3 Commercial Car Park Common Areas and the B3 Commercial Car Park Common Services and Facilities PROVIDED THAT such right shall be subject to the easements, rights and privileges of FSI and shall not in any way adversely affect or prejudice the easements, rights and privileges reserved to FSI under the PDMC and the Government Grant.
 13. Each Share shall during the residue of the Term and any renewal thereof and subject to the covenants and terms contained in the Government Grant and in the PDMC, be held by the person or persons from time to time entitled thereto together with the benefit, insofar as applicable, of the easements, rights and privileges set out in Part I of the Second Schedule to the PDMC, including but not limited to the following rights, easements and privileges:
 - (I) Rights, Easements and Privileges applicable to Owners of the Estate

Full right and liberty (subject always to the rights of the Manager, the First Owner, the Owner of the Tai Wai Station and the Owner of the Government Accommodation) for the Owner of each Unit of the Estate for the time being, his servants, agents, licensees, tenants and lawful occupants (in common with all other persons having the like right) to go, pass and repass over and along and upon and to use such part(s) of the Estate Common Areas and the Estate Common Services and Facilities for all purposes connected with the use and enjoyment of his Unit.
 - (II) Rights, Easements and Privileges applicable to Owners of the Government Accommodation

FSI, its lessees, tenants, licensees and persons authorized by it and the Owners or occupiers for the time being of the Government Accommodation or any part thereof shall have the right to go pass and repass over and along and to use any common parts of the Land or any common parts of the Development in connection with the proper use and enjoyment of the Government Accommodation or any part thereof and to use and receive the benefit of any common facilities within the Land or the Development (which for the avoidance of doubt, "common parts" and "common facilities" herein referred to include the Common Areas and the Common Services and Facilities respectively).
- (III) Rights, Easements and Privileges applicable to all Owners of the Residential Development
 - (a) Full right and liberty (Subject Always to the rights of the Manager, the First Owner, the Owner of the Tai Wai Station and the Owner of the Government Accommodation) for the Owner of a Residential Unit of the Residential Development for the time being, his servants, agents, licensees, tenants and lawful occupants (in common with all other persons having the like right):-
 - (i) to go, pass and repass over and along and upon and to use the Residential Common Areas and the Residential Common Services and Facilities for all purposes connected with the use and enjoyment of his Unit;
 - (ii) to go, pass and repass over and along and upon and to use the Estate Common Areas, the Residential Car Park Common Areas, the Estate Common Services and Facilities and the Residential Car Park Common Services and Facilities, for the purposes of access and egress to and from the drop off areas, the lay-bys, loading and unloading spaces, Bicycle Parking Spaces, the Visitors' Parking Spaces and the EV Facilities for Visitors' Parking Spaces; and
 - (iii) to go, pass and repass over and along and upon and to use such part of the Commercial Development on Basement Level 3 as designated or re-designated by the Owner(s) of the Commercial Development from time to time as necessary for the purposes of access and egress to and from the lift lobby and lifts on Basement Level 3 as shown and coloured brown and yellow respectively and marked "Residential Shuttle Lift Lobby" and "Lift P5" and Lift P6" respectively.
 - (b) Full right and liberty for the residents for the time being, of a Unit in the Residential Development and his bona fide guests and visitors to use and enjoy, for the purpose of recreation only and subject to the rules regulations and fees prescribed for their use by the Manager, the Private Recreational Areas and Facilities intended for use by the residents of the Residential Development and his bona fide guests and visitors PROVIDED that in exercising such right no person shall damage or interfere with or permit or suffer to be damaged or interfered with, the general amenities, plant, equipment or services provided.
 - (IV) Rights, Easements and Privileges applicable to the Owners of the Residential Parking Spaces
 - (a) Full right and liberty (Subject Always to the rights of the Manager, the First Owner, the Owner of the Tai Wai Station and the Owner of the Government Accommodation) for the Owner of a Residential Parking Space for the time being, his servants, agents, licensees, tenants and lawful occupants (in common with all other persons having the like right) to go, pass and repass over and along and upon and to use the Residential Car Park Common Areas and the Residential Car Park Common Services and Facilities for all purposes connected with the use and enjoyment of his Residential Parking Space.

Summary of deed of mutual covenant

公契的摘要

- (b) Subject to the provisions of Clauses 28 and 29 of Section E of the PDMC and to the payment of the management expenses for the Common EV Facilities to be borne by the Owners of EV Parking Spaces, the full right and liberty (Subject Always to the rights of the Manager, the First Owner, the Owner of the Tai Wai Station and the Owner of the Government Accommodation) for the Owner of an EV Parking Space for the time being at his own cost and expense to install, maintain, repair and replace an electric meter and such associated facilities within the EV charger rooms of the Residential Car Park Common Areas and to lay and/or maintain, repair and replace such cables, base box, socket outlets, protective and security devices within the Residential Car Park Common Areas at such locations and in such manner to be approved by the Manager for the purposes of or in connection with the proper use and enjoyment and operation of the Non-Common EV Facilities serving his EV Parking Space exclusively.
- (c) Full right and liberty (Subject Always to the rights of the Manager, the First Owner, the Owner of the Tai Wai Station and the Owner of the Government Accommodation) for the Owner of a Residential Parking Space on Basement Level 3 for the time being, his servants, agents, licensees, tenants and lawful occupants (in common with all other persons having the like right) to go, pass and repass over and along and upon on foot or by wheelchair and to use the B3 Commercial Car Park Common Areas and the B3 Commercial Car Park Common Services and Facilities and such part of the Commercial Development in front of the entrance of the Residential Shuttle Lift Lobby on Basement Level 3 for the purposes of access and egress to and from the Residential Shuttle Lift Lobby on Basement Level 3 and proper use and enjoyment of his Residential Parking Space on Basement Level 3.
14. Each Share shall during the residue of the Term and any renewal thereof and subject to the covenants and terms contained in the Government Grant and in the PDMC, be held by the person or persons from time to time entitled thereto subject to the exceptions and reservations set out in Part II of the Second Schedule to the PDMC, including but not limited to the following exceptions and reservations:
- (I) Rights of Manager
- (a) Full right and privilege for the Manager, with or without surveyors, workmen and others, at all reasonable times on prior reasonable notice (except in case of emergency) to enter on and into each and every part of the Land and the Development including each Unit, the Tai Wai Station (subject to the prior written approval of the Owner of the Tai Wai Station) and the Government Accommodation (subject to the prior written approval (save in case of emergency) of the Owner of the Government Accommodation) for the purposes of carrying out necessary repairs to the Estate including but not limited to inspecting, rebuilding, repairing, renewing, replacing, renovating, maintaining, cleaning, painting or decorating the structure of the Estate, the Common Areas and the Common Services and Facilities or any part or parts thereof, or any Unit in respect of which the Owner shall be in default of its obligations to repair and maintain or for abating any hazard or nuisance which does or may affect the Common Areas, the Common Services and Facilities or other Owners or for the exercise and carrying out of any of its powers and duties under the provisions of the PDMC causing as little disturbance as is reasonably practicable and making good any damage caused thereby Provided That the Manager shall at its own costs and expense repair any damage so caused by the default of the Manager and shall be liable for the negligent, wilful or criminal acts of the Manager, its staff, agents and contractors and Provided Further That in case of the Manager exercising its right of entry into the Tai Wai Station and/or the Government Accommodation pursuant to Clause 2 of Part II of the Second Schedule to the PDMC, such entry shall be for the purposes of maintenance and repair only and the Manager shall be liable for all costs and expenses incurred for any damage caused to the Tai Wai Station and the Government Accommodation.
- (b) The rights for the Manager with or without surveyors contractors workmen and others to carry out all necessary works required by the Director, including the temporary closure of any opening in the building or buildings erected on the Land, other than the Tai Wai Station (except with the prior consent in writing of the Owner of the Tai Wai Station) and provided that the Manager shall be liable for all costs and expenses incurred for any damages caused to the Tai Wai Station so as to enable the erection and connection of the pedestrian walkways or footbridges (if any) to the buildings. The Manager in pursuance of any such works shall notify the Owners in writing as to the areas or parts of the Land and the Development which the Owners may not use while such works are being carried out and the Owners shall comply with the requirements of such notification Provided that the ingress to or egress from the Government Accommodation and/or the Tai Wai Station shall not be interrupted and the proper use and enjoyment of the Government Accommodation and/or the Tai Wai Station shall not be affected Provided that the powers and duties of the Manager under Clause 2 of Part II of the Second Schedule to the PDMC shall be (i) subject to the rights easements and privileges of FSI and shall not in any way adversely affect or prejudice the rights, easements and privileges reserved to FSI under the PDMC and the Government Grant, and (ii) subject to the rights easements and privileges of the Owner of the Tai Wai Station and shall not in any way adversely affect or prejudice the rights, easements and privileges reserved to the Owner of the Tai Wai Station under the PDMC and the Station Assignment.

Summary of deed of mutual covenant

公契的摘要

(II) Rights of First Owner

For so long as the First Owner remains the beneficial owner of any Share (and in addition to any other right which it may have reserved under (i) the Station Assignment and (ii) the Assignment to the Purchaser), the First Owner shall have the exclusive and unrestricted right in its absolute discretion at any time or times and from time to time as it shall deem fit to do all or any of the following acts or deeds and/or to exercise all or any of the following rights, liberty, privileges and entitlement without the necessity of joining in or the concurrence or approval of any other Owner (unless provided otherwise in the PDMC), the Manager or any other person interested in the Land and the Development but subject to the rights easements and privileges reserved to the Owner of the Tai Wai Station and FSI under the PDMC, the Government Grant and the Station Assignment and Provided that such rights easements and privileges of the Owner of the Tai Wai Station and the Owner of the Government Accommodation shall not in any way be adversely affected or prejudiced :

- (a) in accordance with the terms of the Government Grant, to assign upon execution of the PDMC the Common Areas and Common Services and Facilities or any part or parts thereof together with the Shares relating thereto to the Manager, without consideration, for the general benefit of the Owners Provided that upon such assignment such areas and facilities shall be held by the Manager as trustee for all the Owners and if the Manager shall resign or be wound up or are removed in accordance with the provisions of Clause 2 of Section H of the PDMC and another manager appointed in its place, or if required by an Owners Corporation for the Development formed under the Building Management Ordinance then the Manager or its liquidator shall assign such Common Areas and Common Services and Facilities together with the Shares relating thereto (if any) free of costs and consideration to the new manager or Owners Corporation (as appropriate) upon the same trusts;
- (b) without prejudice to sub-clause 3(e) of Part II of the Second Schedule to the PDMC and subject only to obtaining the prior written consent of the Director, to allocate and re-allocate Shares to any particular part of the Estate (excluding the Units which have been assigned by the First Owner) following the issue of an Occupation Permit in respect of that particular part and to each Unit and the Common Areas and Common Services and Facilities and to allocate and re-allocate Management Units to each Unit thereto necessitated by any change in gross floor area Provided that the allocation in or re-allocation of Shares shall not affect the proportion of Shares allocated to the Government Accommodation and no Management Units shall be allocated to the Government Accommodation;

- (c) to construct, maintain, lay, alter, remove, re-route and renew drains, pipes, cables, sewers and other installations, fittings, chambers and other structures within the Land and the Development (other than the services and facilities solely and exclusively serving the Tai Wai Station or the Government Accommodation) or partly within the Land and the Development (other than the services and facilities solely and exclusively serving the Tai Wai Station or the Government Accommodation) and adjoining land to supply utilities services and recreational facilities to the Land and the Development Provided that in exercising any of its rights under sub-clause 3(k) of Part II of the Second Schedule to the PDMC by the First Owner, the First Owner shall not interfere with the Owners' rights to hold, use, occupy and enjoy their Units nor impede access to their Units and Provided further that if the said drains, pipes, cables, sewers, installations, fittings, chambers and structures form parts of the Common Areas or the Common Services and Facilities, the exercise of the aforesaid right shall be subject to the approval by a resolution of Owners at a meeting of the Owners of the Estate convened under the PDMC PROVIDED THAT such approval is not required if the exercise of the aforesaid right is for the purpose of construction, development and completion of Phase 2 and/or the subsequent Phase(s) and any consideration received (if any) shall be credited to the relevant account of the Special Fund and Provided further that in any event no chimneys, flues, pipes or other structures or facilities shall be installed or affixed onto the external walls of the Government Accommodation;
- (d) subject to the approval by a resolution of the Owners of the Estate at a meeting of the Owners of the Estate convened under the PDMC, to obtain for the benefit of the Owners for the time being of the Estate or any part thereof and their servants, agents, licensees, tenants and lawful occupants the grant of any rights, rights of way or easements or quasi easements (including but not limited to the right to use any roads, passageways, walkways, footpaths, pedestrian bridges, gardens, open spaces, recreational areas and facilities, subways, nullahs and culverts, sewage treatment plants and facilities, refuse collection and disposal areas and facilities, drainage system and gas, water and electricity storage, transformation and supply systems) over any adjoining or neighbouring lands or to obtain any similar rights by licence on such terms and condition and from such persons as the First Owner shall deem fit Provided That FSI and the Owner of the Tai Wai Station shall not be made to bear any costs for the acquisition of the said rights, rights of way, easements or quasi-easements.

Summary of deed of mutual covenant

公契的摘要

15. Subject to the rights reserved to the First Owner in Clause 3 of Part II of the Second Schedule to the PDMC, the rights easements and privileges reserved to FSI as the Owner of the Government Accommodation in the PDMC and the Government Grant, the rights granted to and reserved by the Owner of the Tai Wai Station set out in Clause 3 of Part I of the Second Schedule to the PDMC and the rights granted and reserved by KCRC as Owner of the Tai Wai Station under the Station Assignment and rights granted to the Owner(s) of the Commercial Development under Clause 6 of Part I of the Second Schedule to the PDMC, an Owner shall not (except the same shall not constitute any breach of the terms and conditions of the Government Grant and contravention of any ordinances, laws and Government regulations and the previous written consent of the Manager shall have been obtained (which consent may be granted, withheld or granted subject to conditions at its absolute discretion)):
- (a) erect or build or permit or suffer to be erected or built on any roof, flat roof or any part thereof of any building, carport or other structure erected on or in the Estate, or the Common Areas any structure whatsoever whether of a temporary or permanent nature;
 - (b) damage, injure or deface or permit or suffer to be damaged, injured or defaced any part of the structure, fabric or decorative features of the Common Areas including any trees, plants or shrubs in or on the Land and the Development;
 - (c) damage or interfere with or permit or suffer to be damaged or interfered with the Common Services and Facilities;
 - (d) encumber or obstruct or permit or suffer to be encumbered or obstructed with any boxes, dustbins, packaging goods, rubbish, chattels or other obstruction of any kind or nature any of the Common Areas and the Manager shall be entitled without notice and at the Owner's expense to remove and dispose of as they see fit any such material aforesaid and the Manager shall not thereby incur any liability to the Owner or any other person whomsoever (except for criminal liability, dishonesty or negligence on the part of the Manager) and each and every Owner hereby agrees to keep the Manager indemnified against all losses, claims damages or expenses of and against the Manager in respect thereof;
 - (e) bring on to or keep any dogs, cats, pets, livestock, live poultry, birds or other animals on any part of the Estate PROVIDED THAT subject to any applicable laws and regulations in force in Hong Kong from time to time and subject to and in accordance with the Building Rules, domestic animal or other pets may be kept in a Residential Unit unless the same has been the cause of reasonable written complaint by at least two (2) Owners or occupiers of any part of the Estate, the reasonableness of the complaint shall be determined by the Manager at its absolute discretion;
 - (f) in no event permit dogs in lifts or in any part of the Estate intended for common use unless they are (1) carried or on leash and wearing mouth strap; (2) wearing mouth strap; (3) microchipped and vaccinated; (4) licensed by the Agriculture, Fisheries and Conservation Department; and (5) registered with the Manager.
- (g) affix or install onto the external walls or through the windows of any Residential Unit any air-conditioner or air-conditioning unit other than at the air-conditioner platform already provided or at such places designated for such purposes and all possible measures shall be taken to prevent excessive noise, condensation or dripping on to any part of the Land and/or the Estate;
 - (h) tamper with, remove or interfere with or permit or suffer or cause to be tampered with, removed or interfered with the fire alarm system serving the Estate or any part thereof and/or the common fire alarm system installed in the Estate connecting and serving the Estate; and
 - (i) use the Open Space or other open spaces in the Common Areas for any purpose other than those permitted under the Government Grant or for other purposes as may be designated by the Manager with the approval of the Director.
16. (a) Subject to the reserved rights of the First Owner under Clause 3 of Part II of the Second Schedule to the PDMC and the reserved rights of the Owner of the Tai Wai Station under Clause 3 of Part I of the Second Schedule to the PDMC, no Owner (including the First Owner) may convert any of the Common Areas to his own use or for his own benefit unless the approval by a resolution of the Owners Committee has been obtained and such conversion shall not affect the proper use and enjoyment of the Government Accommodation. Any payment received for the approval shall be credited to the relevant accounts of the Special Fund as provided in Clause 2 of Section J of the PDMC.
- (b) Subject to the reserved rights of the First Owner under Clause 3 of Part II of the Second Schedule to the PDMC and the reserved rights of the Owner of the Tai Wai Station under Clause 3 of Part I of the Second Schedule to the PDMC and the rights of the sole Owner of the Commercial Development under Clause 9 of Section C of the PDMC, no Owner (including the First Owner) may convert or designate any of his own areas as Common Areas unless the approval by a resolution of Owners at a meeting of the Owners of the Estate convened under the PDMC or at a meeting of the Owners of the relevant part of the Estate convened under the PDMC or the relevant Sub-Deed of Mutual Covenant (as the case may be) has been obtained and such conversion or designation shall not affect the proper use and enjoyment of the Government Accommodation or the safety and operation of the Tai Wai Station, the KCRC Railway and the Railway Structures and Installations. No Owner (including the First Owner) or the Manager will have the right to re-convert or re-designate the Common Areas to his or its own use or benefit.

Summary of deed of mutual covenant 公契的摘要

B. The number of undivided shares assigned to each residential property in the Phase

Tower	Floor	Flat	No. of Shares allocated to each Flat	Sub-Total
5 (5A)	7/F (1 storey)	A	63	63
		B	58	58
		C	42	42
		D	52	52
		E	42	42
	8/F-16/F, 18/F-39/F & 41/F-61/F (46 storeys)	A	64	2,944
		B	59	2,714
		C	45	2,070
		D	53	2,438
		E	43	1,978
	62/F (1 storey)	A	123	123
		C	63	63
		D	57	57
		E	46	46
5 (5B)	7/F (1 storey)	A	60	60
		B	62	62
		C	54	54
		D	47	47
	8/F-16/F, 18/F-39/F & 41/F-61/F (46 storeys)	A	63	2,898
		B	62	2,852
		C	54	2,484
		D	49	2,254
	62/F (1 storey)	A	133	133
		C	57	57
D		52	52	

Tower	Floor	Flat	No. of Shares allocated to each Flat	Sub-Total
6 (6A)	7/F (1 storey)	A	66	66
		B	59	59
		C	41	41
		D	40	40
		E	44	44
	8/F-16/F & 18/F-39/F (27 storeys)	A	63	1,701
		B	59	1,593
		C	46	1,242
		D	42	1,134
		E	46	1,242
	41/F-61/F (19 storeys)	A	63	1,197
		B	59	1,121
		C	46	874
		D	42	798
		E	46	874
	62/F (1 storey)	A	130	130
		C	48	48
		D	45	45
		E	50	50
		F	42	42
6 (6B)	7/F (1 storey)	A	65	65
		C	51	51
		D	25	25
		E	31	31
		F	42	42
	8/F-16/F & 18/F-39/F (27 storeys)	A	64	1,728
		C	52	1,404
		D	25	675
		E	32	864
		F	44	1,188
	41/F-61/F (19 storeys)	A	64	1,216
		C	81	1,539
		E	32	608
		F	44	836
	62/F (1 storey)	A	69	69
C		86	86	
E		35	35	
F		47	47	

Summary of deed of mutual covenant 公契的摘要

Tower	Floor	Flat	No. of Shares allocated to each Flat	Sub-Total
7 (7A)	7/F (1 storey)	A	64	64
		B	65	65
		C	41	41
		D	30	30
		E	25	25
		F	32	32
	8/F-16/F, 18/F-39/F & 41/F-61/F (46 storeys)	A	62	2,852
		B	65	2,990
		C	43	1,978
		D	31	1,426
		E	25	1,150
		F	33	1,518
	62/F (1 storey)	A	134	134
		C	46	46
		D	33	33
		E	27	27
		F	35	35
	7 (7B)	7/F (1 storey)	A	60
B			56	56
C			30	30
D			70	70
E			44	44
8/F-16/F, 18/F-39/F & 41/F-61/F (46 storeys)		A	63	2,898
		B	58	2,668
		C	31	1,426
		D	70	3,220
		E	47	2,162
62/F (1 storey)		A	68	68
		B	62	62
		C	33	33
		D	123	123

C. The term of years for which the manager of the Phase is appointed

Subject to the Building Management Ordinance, the Manager of the Phase shall be appointed for an initial period of two (2) years commencing on the date of the PDMC and to be continued thereafter until termination of the Manager's appointment in accordance with the provisions of the PDMC.

D. The basis on which the management expenses are shared among the owners of the residential properties in the Phase

1. Subject to sub-clauses (b)(II) and (b)(III) of Clause 5 of Section J of the PDMC, the Owners (save and except the Owner of the Tai Wai Station and the Owner of the Government Accommodation) shall contribute towards the Management Charges in the following manner:-
 - (i) all Owners of Units in the Estate (save and except FSI as the Owner of the Government Accommodation) shall contribute to the expenses of the Estate Management Budget in the proportion that the Management Units attributable to the Units owned by them bears to the total Management Units allocated to the Estate;
 - (ii) the Owners of the Residential Units shall contribute to the expenses of the Residential Development Management Budget in the proportion that the Management Units attributable to the Residential Units owned by them bears to the total Management Units allocated to the Residential Development;
 - (iii) the Owners of the Residential Parking Spaces shall contribute to the expenses of the Residential Car Park Management Budget in the proportion that the Management Units attributable to such Residential Parking Spaces owned by them bears to the total Management Units allocated to all Residential Parking Spaces. Provided That all management and maintenance expenditure of the Common EV Facilities shall be borne by the Owners of the EV Parking Spaces only in the proportion that the Management Units allocated to their respective EV Parking Spaces bears to the total Management Units allocated to all the EV Parking Spaces;
 - (iv) subject to Clause 11 of Section C of the PDMC, the Owners of the B3 Commercial Car Parking Spaces shall contribute to the expenses of the B3 Commercial Car Park Management Budget in the proportion that the Management Units attributable to such B3 Commercial Car Parking Spaces owned by them bears to the total Management Units allocated to all B3 Commercial Car Parking Spaces (the sub-allocation of Management Units to the B3 Commercial Car Parking Spaces shall be dealt with in the Sub-Deed of Mutual Covenant in respect of the Commercial Development);

Provided That where the Manager prepares sub-budgets or sub-sub-budgets for any part of the Estate other than the above budgets, only the expenses which are attributable to that part as a whole shall be apportioned and the expenses of any sub-budget or sub-sub-budget shall be paid by the Owners of Units covered by such a sub-budget or sub-sub-budget in the proportion that the Management Units attributable to the Units owned by them bears to the total number of Management Units allocated to the relevant part of the Estate covered by such a sub-budget or sub-sub-budget.

Summary of deed of mutual covenant

公契的摘要

2. Since the Residential Car Park Common Areas also serve and benefit the Visitors' Parking Spaces and the Bicycle Parking Spaces which are Residential Common Areas, 7.532% of the expenditure for management and maintenance of the Residential Car Park Common Areas, including the contribution to the residential car park account of the Special Fund, will be incurred solely for the benefits of all of the Owners of the Residential Units. As such, the Manager will charge all of the Owners of the Residential Units of the said percentages of the expenditures, so that the Owners of the Residential Units shall contribute to 7.532% of the costs and expenses of the Residential Car Park Management Budget in the proportion that the Management Units attributable to the Residential Units owned by them bear in particular to the total Management Units attributable to all Residential Units.
3. Notwithstanding anything contained in the PDMC to the contrary, the Owner of the Tai Wai Station shall share, and contribute to, the costs and expenses of the Estate Management Budget in so far as the same is attributable to the maintenance and management of the Existing Public Toilet Items, the PSC Items and the PTI Items but not otherwise and the expenditure for major works of a capital nature or of a kind not expected to be incurred annually in respect of the Existing Public Toilet Items, the PSC Items and the PTI Items. The Owner of the Tai Wai Station and the Owners of the Estate (save and except the Owner of the Government Accommodation) shall contribute to the costs and expenses of the Estate Management Budget in so far as the same is attributable to the maintenance and management of the Existing Public Toilet Items, the PSC Items and the PTI Items and the expenditure for major works of a capital nature or of a kind not expected to be incurred annually in respect of the Existing Public Toilet Items, the PSC Items and the PTI Items in the proportion that the respective gross floor areas of the Tai Wai Station and the Estate (excluding the gross floor area of the Government Accommodation) bears to the total gross floor area of the Development (excluding the gross floor area of the Government Accommodation). As such, 8.474% of such costs, expenses and expenditure of the Existing Public Toilet Items, the PSC Items and the PTI Items and the expenditure for major works of a capital nature or of a kind not expected to be incurred annually in respect of the Existing Public Toilet Items, the PSC Items and the PTI Items shall therefore be borne by the Owner of the Tai Wai Station and the remaining 91.526% of the said costs, expenses and expenditure shall be borne by the Owners of the Estate (save and except the Owner of the Government Accommodation).

E. The basis on which the management fee deposit is fixed

The amount of management fee deposit is equivalent to three (3) months' Management Charges.

F. Summary of the provisions of the PDMC that deal with the area (if any) in the Phase retained by the owner for that owner's own use

Not applicable.

Note:

Unless otherwise defined in this Sales Brochure, capitalized terms used in the above shall have the same meaning of such capitalized terms used in the PDMC.

Summary of deed of mutual covenant

公契的摘要

A. 主公契及管理協議擬稿（「主公契」）中有關期數公用部分的條文摘要

- 「公用地方」指屋苑公用地方、住宅公用地方、住宅停車場公用地方、地庫第3層商業停車場公用地方及第一業主（不包括其繼承人及受讓人）將按主公契規定訂立的任何副公契或單方契據所指定（在其夾附的圖則上詳細標明）作為公用地方的屋苑該等部分，但不包括屬於任何個別單位的業主或僅服務任何個別單位的住宅發展項目之部分或住宅停車位，亦不包括所有商業發展項目之部分。
- 「公用服務和設施」指屋苑公用服務和設施、住宅公用服務和設施、住宅停車場公用服務和設施、地庫第3層商業停車場公用服務和設施及第一業主（不包括其繼承人及受讓人）將按主公契規定訂立的任何副公契或單方契據所指定作為公用服務和設施的屋苑該等服務和設施，但不包括屬於任何個別單位的業主或僅服務任何個別單位的該等服務和設施，亦不包括服務商業發展項目或其任何部分的該等服務和設施。
- 「屋苑公用地方」指屋苑內擬供整個屋苑的業主使用而並非供屋苑的個別業主或若干業主單獨享用的該等部分，包括但不限於服務整個屋苑的所有綠化範圍，大圍站的上層邊界上面屋苑部分的所有樓板（包括所有在防水膜及系統上面的樓板及其上面的輔助防護結構），服務屋苑的一切公用事業、服務設施、槽、井及設施、屋苑的所有飾面、部分後移範圍、部分24小時行人道、部分行人通道、渠務專用範圍或新渠務專用範圍（視情況而定）、水務設施專用範圍、行車道、升降機、進出通道、公共停車處、專上學院停車處、現有公廁項目、專上學院項目、公共運輸交匯處項目、地庫4層至地庫1層的中空牆及隔膜牆、3樓天花板下面的外牆、飾面及建築裝飾（不包括附屬商業發展項目的外牆部分及其飾面及建築裝飾）、6樓天花水平上面的鼓形斜坡至天台層的外牆、斜道、升降機槽、穿梭升降機、行人路、樓梯、梯台、走廊及通道；泵房、變壓器房、總電掣房、電房、消防控制室、主儀錶櫃及水錶房、燃油箱房、街道消防柱連花灑及消防泵房、風機房、花灑控制閥室、管槽、緊急發電機房、通風井、垃圾收集及物料回收房；按政府批地文件特別條件第(52)(b)(i)條提供的垃圾收集站及垃圾收集車輛停泊和裝卸用的停車位；屋苑內的建築物的護牆、結構牆及支柱、地基及其他結構件；管理處、保安室、警衛室、管理員宿舍、業主委員會及/或業主立案法團辦事處、儲物室、洗手間及屋苑內用作管理員辦事處的其他範圍或業主委員會或業主立案法團的其他設施和屋苑內並非供屋苑任何個別業主或若干業主單獨享用的一切其他公用地方（但不包括所有商業發展項目部分、住宅公用地方、住宅停車場公用地方、地庫第3層商業停車場公用地方及第一業主將按主公契規定訂立的任何副公契或單方契據所指定作為其他公用地方的該等部分）。第1期和第2期的屋苑公用地方（如果可以在圖則上顯示）在主公契所夾附的圖則上以綠色、綠色間黑斜線及綠色間黑交叉線顯示並（如果可以在圖則上顯示）在主公契所夾附的公用地方分界圖則上以綠色、綠色間黑斜線及綠色間黑交叉線顯示（指第1期內該等部分）和以綠色間紅虛線斜線顯示（指第2期內該等部分），僅作識別之用。其他期數的屋苑公用地方則在該等其他期數的副公契或單方契據所夾附的圖則上顯示。
- 「屋苑公用服務和設施」指在發展項目之內、之上或之下已建或擬建服務整個屋苑而並非供屋苑任何個別業主或若干業主單獨享用的該等服務和設施，包括但不限於污水渠、明渠、排水渠、水道、管道及槽；泵、水箱及衛生裝置；電線、電纜、電力裝置、裝置、設備及器具；火警鐘、消防及滅火系統、設備及器具；街道消防栓水箱、消防水箱、花灑水箱、保安系統、設備及器具；垃圾處理設備、通風及空調機及設備；空調機及風機和屋苑內使用或安裝作為其便利設施供屋苑共同使用與享用而並非供屋苑任何個別業主或若干業主單獨享用的任何其他裝置、系統、機械、設備、器具、裝置、服務及設施，現有公共廁所項目、專上學院項目及公共運輸交匯處項目，（但不包括所有商業發展項目部分、住宅公用服務和設施、住宅停車場公用服務和設施、地庫第3層商業停車場公用服務和設施及第一業主將按主公契規定訂立的任何副公契或單方契據所指定作為其他公用服務和設施的該等服務和設施）。
- 「住宅公用地方」指住宅發展項目內擬供住宅發展項目的業主共同使用而並非供任何個別住宅單位業主單獨享用的該等部分，包括但不限於轉換層、部分行人通道、有蓋行人路連同其頂部綠化、服務整個住宅發展項目的所有綠化範圍、及大圍站的上層邊界之上的住宅發展項目部分的所有樓板，包括所有在防水膜及系統上面的樓板及其上面的輔助防護結構，和服務住宅發展項目或其任何部分的一切公用事業、服務設施、槽、井及設施、以及住宅發展項目的一切飾面、4樓上面和5樓下面的大圍站天台上面安置機電裝置的區域、5樓的天台上面和6樓下面的不可進入中空、緊急車輛通道、行車道、安裝或使用無線廣播分導或電訊網絡設施的區域、衛星電視共用天線房（SMATV）、住宅入口大堂、住宅穿梭升降機大堂、升降機機房、樓梯、梯台、行人道、走廊及通道、庇護層、園景區、公共平台花園及隔音簷片、升降機槽、機械及設備房、平台地板、垃圾房、游泳池過濾機房、沖廁水箱房、食水及清潔水箱房、天台及平台、空調機平台（包括任何附屬格柵）、大廈的建築裝飾和輔助承托橫樑及支柱、大廈外牆（包括幕牆或其任何部分）（包括幕牆的窗框、玻璃板、鉸鏈、鎖、把手、鑄入錨、墊片、窗戶密封膠及其他組件，其內或其處安裝的不可開合窗戶及不可開合窗戶的窗框、玻璃板、鑄入錨、墊片、窗戶密封膠及其他組件，但不包括其內安裝的一切可開合窗戶和圍住可開合窗戶的玻璃板的窗框、可開合窗戶的玻璃板、鉸鏈、鎖、把手、鑄入錨、墊片、窗戶密封膠及其他組件）、住宅發展項目之內或附帶的非結構預製外牆、護牆、結構牆及支柱，按政府批地文件特別條件第(44)(a)(i)條提供貨車裝卸的停車位、訪客停車位、單車停車位、管理員櫃枱、私人康樂區及設施、遊樂場、消防泵房、變壓器房、電掣房、主電訊廣播設備房、電訊槽、緊急發電機房、水泵房、風機房、水錶櫃房、風櫃房、過濾機房、管槽、電纜槽、通風井、郵箱、天窗、簷篷、草坪、水裝飾、花槽、行人路、休憩處、其他露天地方、噪音緩解措施（附屬單位一部分的除外）及指定供住宅發展項目享用的其他地方，但不包括地庫第3層商業停車場公用地方內的任何東西，屋苑公用地方及住宅停車場公用地方。第1期和第2期的住宅公用地方（如果可以在圖則上顯示）在主公契所夾附的圖則上以黃色和黃色加黑點顯示並（如果可以在圖則上顯示）在主公契所夾附的公用地方分界圖則上以黃色和黃色加黑點顯示（指第1期內該等部分）和以黃色間紅虛線斜線和黃色加黑點間紅虛線斜線顯示（指第2期內該等部分），僅作識別之用。其他期數的住宅公用地方則在該等其他期數的副公契或單方契據所夾附的圖則上顯示。
- 「住宅公用服務和設施」指在發展項目之內、之上或之下已建或擬建服務住宅發展項目而並非供任何個別住宅單位業主單獨享用的該等服務和設施，包括但不限於訪客停車位的電動車充電設施、無線廣播分導或電訊網絡設施、排水渠、渠道、水箱、導管、管道、電纜、電線、機械及機器、空調及通風系統、電力裝置、固定物、設備及器具、升降機、滅火裝置及設備、保安系統及器具及吊船，但不包括地庫3層商業停車場公用服務和設施、屋苑公用服務和設施及住宅停車場公用服務和設施內的任何東西。
- 「住宅停車場公用地方」指住宅停車場內擬供 (i) 住宅停車位；(ii) 訪客停車位；及 (iii) 單車停車位的業主、佔用人及被許可人共同使用與享用的該等部分，包括但不限於住宅停車場圍封牆的內側飾面、一切通道區、迴旋通道、樓梯、梯台、上落客區、斜道、行車道、風機房、通風井、消防水箱、泵房、停車場升降機大堂及電動車充電器房，但不包括地庫第3層商業停車場公用地方、屋苑公用地方及住宅公用地方內的任何東西。第1期和第2期的住宅停車場公用地方（如果可以在圖則上顯示）在主公契所夾附的圖則上以棕色顯示並（如果可以在圖則上顯示）在主公契所夾附的公用地方分界圖則上以棕色顯示（指第1期內該等部分）和以棕色間紅虛線斜線顯示（指第2期內該等部分），僅作識別之用。其他期數的住宅停車場公用地方則在該等其他期數的副公契或單方契據所夾附的圖則上顯示。
- 「住宅停車場公用服務和設施」指在住宅停車場之內、之上或之下建造服務住宅停車位的該等服務和設施，包括但不限於機械及機器、機電通風裝置、固定物及設備、供水裝置、排水渠、渠道、控制閘、排煙槽、滅火裝置及設備、保安系統及器具及公用電動車充電設施，但不包括地庫3層商業停車場公用服務和設施、屋苑公用服務和設施及住宅公用服務和設施內的任何東西。

Summary of deed of mutual covenant

公契的摘要

9. 「地庫第3層商業停車場公用地方」指地庫第3層內提供地庫第3層商業停車位的業主、佔用人及被許可人和他們的真正賓客、訪客或被邀請人共同使用與享用的部分行車道及迴旋區。地庫第3層商業停車場公用地方（如果可以在圖則上顯示）在主公契所夾附的地庫第3層樓面圖則上以淺棕色顯示，僅作識別之用。
10. 「地庫第3層商業停車場公用服務和設施」指服務地庫第3層商業停車位的該等服務和設施，包括但不限於機械及機器、電力及機械通風裝置、裝置及設備、供水裝置、排水渠、渠道、控制閘、排煙槽、滅火裝置及設備、保安系統及器具。
11. 遵從《建築物管理條例》和主公契的規定，由管理人專有控制公用地方及公用服務和設施。管理人有權力及責任按主公契妥善保養與維護公用地方及公用服務和設施。在行使主公契C章第11（a）條載有上述權利時，商業發展項目的業主須履行主公契I章第1（b）條規定有關地庫第3層商業停車場公用地方和地庫第3層商業停車場公用服務和設施的責任，並採用相同於屋苑其餘部分的管理標準。上述權利僅在單一業主獨家擁有商業發展項目時生效。當商業發展項目被劃分為數個擁有權時，地庫第3層商業停車場公用地方和地庫第3層商業停車場公用服務和設施的管理權須歸還給管理人。
12. 如果任何業主獨家擁有整個商業發展項目，則該業主可自行選擇行使管理地庫第3層商業停車場公用地方和地庫第3層商業停車場公用服務和設施的權利，但是該權利須受制於財政司司長法團的地役權、權利及特權，並在任何方面不能影響或損害主公契和政府批地文件保留給財政司司長法團的地役權、權利及特權。
13. 在政府批地文件的批租餘下年期及其續期期間，受制於政府批地文件和主公契載有的契諾及條款，每份份數應由不時有權擁有的人士持有並享有主公契第一附表第1部分列明的地役權、權利及特權之實益，包括但不限於下列地役權、權利及特權：

(I) 適用於屋苑業主的權利、地役權及特權

屋苑每個單位當時的業主、他的僱工、代理人、被許可人、租客及合法佔用人具有充分權利及自由（始終受制於管理人、第一業主、大圍站擁有人及政府樓宇業主的權利）（與具有類似權利的一切其他人士共同）出入、經過、再經過及使用屋苑公用地方及屋苑公用服務和設施，作使用與享用他的單位有關的一切用途。

(II) 適用於政府樓宇業主的權利、地役權及特權

財政司司長法團、其承租人、租客、被許可人及其授權的人士和當時政府樓宇或其任何部分的業主或佔用人有權出入、經過、再經過及使用該土地的任何公用部分或發展項目的任何公用部分，旨在正當使用與享用政府樓宇或其任何部分和使用與享用該地段或發展項目內任何公用設施（為免存疑，本文所述的「公用部分」及「公用設施」包括公用地方及公用服務和設施）。

(III) 適用於所有住宅發展項目業主的權利、地役權及特權

- (a) 住宅發展項目的住宅單位當時的業主、他的僱工、代理人、被許可人、代理人及合法佔用人具有充分權利及自由（始終受制於管理人、第一業主、大圍站擁有人及政府樓宇業主的權利）（與具有類似權利的一切其他人士共同）：
 - (i) 出入、經過、再經過及使用住宅公用地方及住宅公用服務和設施，作使用與享用他的單位有關的一切用途；
 - (ii) 出入、經過、再經過及使用屋苑公用地方、住宅停車場公用地方、屋苑公用服務和設施及住宅停車場公用服務和設施，以便出入及來往上落客區、停車處、上落貨停車位、單車停車位、訪客停車位及訪客停車位的電動車充電設施；及
 - (iii) 出入、經過、再經過及使用當時商業發展項目業主劃定或重新劃定地庫第3層的商業發展項目的該等部分，以便出入及來往在圖則上以黃色顯示並註明「住宅穿梭升降機大堂」和「升降機P5」和「升降機P6」的地庫第3層的升降機大堂和升降機。
- (b) 住宅發展項目的單位當時的住戶及其真正賓客及訪客具有充分權利及自由，在僅作康樂用途及受制於管理人訂立的規則並繳交訂明的費用下，使用與享用提供住宅發展項目住戶及其真正賓客及訪客使用的私人康樂區及設施，但是在行使上述權利時，任何人士不可損壞或干擾或准許或容許他人損壞或干擾現有的一般便利設施、機械、設備或服務設施。

(IV) 適用於住宅停車位業主的權利、地役權及特權

- (a) 當時住宅停車位業主及其僱工、代理人、被許可人、租客及合法佔用人具有充分權利及自由（始終受制於管理人、第一業主、大圍站擁有人及政府樓宇業主的權利）（與具有類似權利的一切其他人士共同）出入、經過、再經過及使用住宅停車場公用地方及住宅停車場公用服務和設施，作使用與享用他的住宅停車位有關的一切用途；
- (b) 受制於主公契E章第28和29條規定，在繳付電動車停車位業主承擔的公用電動車充電設施的管理開支後，電動車停車位當時的業主具有充分權利及自由（始終受制於管理人、第一業主、大圍站擁有人及政府樓宇業主的權利）自費在住宅停車場公用地方的電動車充電器房內安裝、保養、維修及更換電錶及其輔助設施並按管理人批准的方式在其指定的位置鋪設及/或保養、維修及更換電纜、底盒、插座、防護及保安裝置，以便正當使用、享用及操作專門服務他的電動車停車位的非公用電動車充電設施。
- (c) 當時地庫第3層的住宅停車位業主、他的僱工、代理人、被許可人、租客及合法佔用人具有充分權利及自由（始終受制於管理人、第一業主、大圍站擁有人及政府樓宇業主的權利）（與具有類似權利的一切其他人士共同）步行或乘坐輪椅出入、經過、再經過及使用地庫第3層商業停車場公用地方、地庫第3層商業停車場公用服務和設施、地庫第3層住宅穿梭升降機大堂入口前面的商業發展項目之該等部分，以便出入及來往地庫第3層住宅穿梭升降機大堂和正當使用與享用他在地庫第3層的住宅停車位。

Summary of deed of mutual covenant

公契的摘要

14. 在政府批地文件的批租餘下年期及其續期期間，受制於政府批地文件和主公契載有的契諾及條款，每份份數應由不時有權擁有的人士持有，並受制於主公契第一附表第2部分列明的豁免權及保留權，包括但不限於下列豁免權及保留權：

(I) 管理人的權利

(a) 管理人具有充分權利及特權經合理事先通知（緊急情況除外）帶同或不帶同測量師、工人及其他人在任何合理時間內進入該土地及發展項目任何部分包括每個單位、大圍站（須取得大圍站擁有人的事先書面批准）和政府樓宇業主（須取得政府樓宇業主的事先書面批准（緊急情況除外）），旨在對屋苑進行必要的維修，包括但不限於視察、重建、維修、翻新、更換、修復、保養、清潔、髹漆或裝飾屋苑的構築物、公用地方及公用服務和設施或其任何部分或單位（若其業主不履行維修及保養責任）或減少對公用地方、公用服務和設施或其他業主造成的損害或滋擾或行使與履行它在主公契的權力及職責（並盡量減少干擾並修復因此造成的任何損壞），但是管理人須自費維修管理人的失責造成的任何損壞並對管理人、他的職員、代理人及承辦商的疏忽、蓄意或刑事行為負責。而且倘若管理人按主公契第二附表第2部分第2條行使其權利進入大圍站及/或政府樓宇，上述進入僅限於維修及保養之目的，管理人並須對損壞大圍站和政府樓宇所產生的一切費用負責。

(b) 管理人有權帶同或不帶同測量師、承辦商、工人及其他人士進行署長要求的一切必要工程，包括臨時關閉該土地的任何建築物的任何出口（大圍站除外，除非取得大圍站擁有人的事先書面批准）（且管理人須對因此造成大圍站的任何損壞所產生的一切費用及開支負責），以便建造與連接通往建築物的行人通道或行人天橋（如有）。管理人在進行上述工程時必須書面通知業主，在工程進行期間業主不可以使用該土地及發展項目的有關區域或部分，但須以下列條件作為前提：不能干擾出入政府樓宇及/或大圍站和不能影響正當使用與享用政府樓宇及/或大圍站，又須以下列條件作為前提：管理人在行使主公契第二附表第2部分第2條的權利及職責必須（i）受制於財政司司長法團的權利、地役權及特權，不能在任何方面影響或損害主公契和政府批地文件保留給財政司司長法團權利、地役權及特權；及（ii）受制於大圍站擁有人的權利、地役權及特權，不能在任何方面影響或損害主公契和車站轉讓契約保留給大圍站擁有人的權利、地役權及特權。

(II) 第一業主的權利

只要第一業主仍然是任何份數的實益業主（除了（i）車站轉讓契約；及（ii）轉讓給買方的轉讓契可能保留的任何其他權利外），第一業主具有專有及不受限制的權利，在它認為合適的任何時候及不時絕對酌情作出下列行為、行動及/或行使下列全部的權利，自由、特權及所有權，毋須其他業主（主公契另有規定除外），管理人或在該土地及發展項目有權益的任何其他人士的參與或一致同意或批准，但須以下列條件作為前提：必須受制於主公契、政府批地文件及車站轉讓契約保留給大圍站擁有人的權利及財政司司長法團的權利、地役權及特權，又須以下列條件作為前提：不能在任何方面影響或損害大圍站擁有人的權利及政府樓宇業主的權利、地役權及特權：

(a) 根據政府批地文件的規定，在訂立主公契時免代價轉讓公用地方及公用服務和設施或其任何部分連同其份數給管理人作為業主的基本實益，但是在上述轉讓後該等地方及設施須由管理人以受託人身份為所有業主持有。如果管理人按主公契H章第2條規定辭任或被清盤或被免職及委任另一個管理人接任或如果按《建築物管理條例》成立發展項目的業主立法法團，則管理人或它的清盤人須免費用及代價轉讓該等公用地方及公用服務和設施連同其份數給新管理人或業主立法法團（如適用），由他們以信託形式持有。

(b) 茲毋損主公契第二附表第2部分3（e）款，僅在取得署長事先書面同意後，根據總樓面面積的變更分配及再分配份數給屋苑已獲發出佔用許可證的任何個別部分（不包括第一業主已轉讓的單位）、單位、公用地方及公用服務和設施並分配及再分配管理份數給每個單位，但須以下列條件作為前提：上述分配或再分配份數不能影響已分配給政府樓宇的份數比例和不得分配管理份數給政府樓宇。

(c) 在該土地及發展項目內（僅服務大圍站或政府樓宇的服務及設施除外）或部分在該土地及發展項目內（僅服務大圍站或政府樓宇的服務及設施除外）和部分在毗鄰土地內建築、保養、鋪設、更改、移除、改道及翻新排水渠、管道、電纜、污水渠及其他裝置、固定物、室及其他構築物，以便供應公用事業服務及康樂設施給該土地及發展項目，但須以下列條件作為前提：第一業主在行使主公契第二附表第2部分3（k）款的權利時，第一業主不能干涉業主持有、使用、佔用及享用他們單位的權利，亦不能阻礙出入他們的單位，又須以下列條件作為前提：如果上述排水渠、管道、電纜、污水渠及其他裝置、固定物、室及其他構築物構成公用地方及公用服務和設施一部分，行使上述權利須經屋苑業主在按主公契召開的屋苑業主大會上通過決議批准，又須以下列條件作為前提：如果行使上述權利是為了建造、發展及完成第2期及/或餘下期數，則毋須上述批准，所收取的任何代價（如有）須撥入特別基金的有關賬戶，又須以下列條件作為前提：在任何情況下不能在政府樓宇的外牆安裝或固定任何煙囪、煙道、管道或其他構築物或設施。

(d) 經取得屋苑業主在按主公契召開的屋苑業主大會通過決議批准，為了屋苑或其任何部分當時的業主和他們的傭工、代理人、被許可人、租客及合法佔用人的實益取得通過毗鄰或毗連土地的任何權利、道路權、地役權或準地役權（包括但不限於使用任何道路、通道、行人道、行人路、行人天橋、花園、露天地方、康樂區及設施、行人隧道、明渠及暗渠、污水渠處理機及設施、垃圾收集及處理區及設施，排水系統及水電煤氣儲存、轉換及供應系統）或按第一業主認為合適的條款、條件及人士通過許可證取得任何類似權利，但須以下列條件作為前提：財政司司長法團和大圍站擁有人不得就取得上述權利、道路權、地役權或準地役權承擔任何開支。

15. 受制於主公契第二附表第2部分第3條保留給第一業主的權利、主公契和政府批地文件保留給財政司司長法團作為政府樓宇業主的權利、主公契第二附表第1部分第3條賦予及保留給大圍站擁有人的權利、車站轉讓契約賦予及保留給九廣鐵路作為大圍站擁有人的權利及主公契第二附表第1部分第6條賦予商業發展項目業主的權利，任何業主不得（除非沒有違反政府批地文件的條款及條件和任何條例、法例及政府規定，並已經取得管理人事先書面同意（該同意可授予或拒絕授予或按其酌情決定的條件授予））：

(a) 在屋苑的任何建築物的天台、平台或其任何部分、停車位或其他構築物搭建或建造或准許或容許他人搭建或建造任何臨時或永久性質的構築物；

(b) 損壞、損傷或刮花或准許或容許他人損壞、損傷或刮花公用地方的任何構築物、飾面或裝飾，包括在該土地及發展項目的任何樹木、植物或灌叢；

(c) 損壞或干擾或准許或容許他人損壞或干擾公用服務和設施；

(d) 以任何箱盒、垃圾筒、包裝物、廢物、雜物或其他任何種類的阻塞物妨礙或阻塞任何公用地方，或准許或容許他人妨礙或阻塞之，管理人有權按他們認為合適的方式移走及處理上述任何物件而毋須通知，而有關費用則由業主承擔，且管理人毋須就此對業主或任何人士承擔任何責任（屬於管理人的刑事責任、不誠實或疏忽除外）。每個業主特此同意對管理人因此蒙受的一切損失、索償、損害或開支彌償管理人；

Summary of deed of mutual covenant 公契的摘要

- (e) 在屋苑任何部分攜帶或飼養任何狗貓、寵物、牲畜、活禽、雀鳥或其他動物，但是在符合香港當時施行的任何適用法例及規例和符合大廈守則的規定下，可以在住宅單位內飼養家畜或其他寵物，除非受到屋苑任何部分至少2個業主或佔用人的合理書面投訴，投訴是否合理由管理人絕對酌情決定；
- (f) 在任何情況下不准狗隻進入升降機或屋苑內任何公用部分，除非（1）有攜帶或用狗帶牽引並套上口罩；（2）保持套上口罩；（3）已植入芯片及接種疫苗；（4）已獲漁農自然護理署發牌；及（5）已向管理人登記；
- (g) 在任何住宅單位的外牆或穿過窗戶固定或安裝任何空調機（已提供的空調機平台或指定作該用途的地方除外），並須採取一切必要措施防止產生過量噪音、冷凝或滴水到該土地及/或屋苑的任何部分；
- (h) 竄改、移除或干擾或准許或容許或促使他人竄改、移除或干擾服務屋苑或其任何部分的火警鐘系統及/或在屋苑內安裝連接及服務屋苑的公共火警鐘系統；
- (i) 使用休憩處或公用地方的其他露天地方作有別於政府批地文件准許的用途或管理人經署長批准指定的其他用途。
16. (a) 受制於主公契第二附表第2部分第3條保留給第一業主的權利和主公契第二附表第1部分第3條保留給大圍站擁有人的權利，任何業主（包括第一業主）不能轉換任何公用地方供他自己使用或享用，除非取得業主委員會通過決議批准。上述轉換不能影響政府樓宇的正當使用與享用。上述批准收到的一切款項須撥入主公契J章第2條規定設立的特別基金的有關賬戶。
- (b) 受制於主公契第二附表第2部分第3條保留給第一業主的權利、主公契第二附表第1部分第3條保留給大圍站擁有人的權利及商業發展項目的單一業主根據主公契C章第9條享有的權利，任何業主（包括第一業主）不能轉換或指定他擁有的區域作為公用地方，除非取得屋苑業主在按主公契召開的屋苑業主大會或按主公契或有關副公契（視情況而定）召開的屋苑有關部分業主大會通過決議批准。上述轉換或指定不能影響政府樓宇的正當使用與享用或大圍站、九廣鐵路及鐵路構築物及裝置的安全及運作。任何業主（包括第一業主）或管理人無權再轉換或再指定公用地方供他自己使用或享用。

B. 分配予期數中的每個住宅物業的不分割份數的數目

座	樓層	單位	分配予每個單位的份數的數目	小計
5 (5A)	7樓 (1層)	A	63	63
		B	58	58
		C	42	42
		D	52	52
		E	42	42
	8樓至16樓、 18樓至39樓和 41樓至61樓 (46層)	A	64	2,944
		B	59	2,714
		C	45	2,070
		D	53	2,438
		E	43	1,978
	62樓 (1層)	A	123	123
		C	63	63
		D	57	57
		E	46	46
	5 (5B)	7樓 (1層)	A	60
B			62	62
C			54	54
D			47	47
8樓至16樓、 18樓至39樓和 41樓至61樓 (46層)		A	63	2,898
		B	62	2,852
		C	54	2,484
		D	49	2,254
62樓 (1層)		A	133	133
		C	57	57
		D	52	52

Summary of deed of mutual covenant
公契的摘要

座	樓層	單位	分配予每個單位的份數的數目	小計
6 (6A)	7樓 (1層)	A	66	66
		B	59	59
		C	41	41
		D	40	40
		E	44	44
	8樓至16樓和 18樓至39樓 (27層)	A	63	1,701
		B	59	1,593
		C	46	1,242
		D	42	1,134
		E	46	1,242
	41樓至61樓 (19層)	A	63	1,197
		B	59	1,121
		C	46	874
		D	42	798
		E	46	874
	62樓 (1層)	A	130	130
C		48	48	
D		45	45	
E		50	50	
6 (6B)	7樓 (1層)	A	65	65
		C	51	51
		D	25	25
		E	31	31
		F	42	42
	8樓至16樓和 18樓至39樓 (27層)	A	64	1,728
		C	52	1,404
		D	25	675
		E	32	864
		F	44	1,188
	41樓至61樓 (19層)	A	64	1,216
		C	81	1,539
		E	32	608
		F	44	836
	62樓 (1層)	A	69	69
		C	86	86
E		35	35	
F		47	47	

座	樓層	單位	分配予每個單位的份數的數目	小計
7 (7A)	7樓 (1層)	A	64	64
		B	65	65
		C	41	41
		D	30	30
		E	25	25
		F	32	32
	8樓至16樓、 18樓至39樓和 41樓至61樓 (46層)	A	62	2,852
		B	65	2,990
		C	43	1,978
		D	31	1,426
		E	25	1,150
		F	33	1,518
	62樓 (1層)	A	134	134
		C	46	46
		D	33	33
		E	27	27
7 (7B)	7樓 (1層)	A	60	60
		B	56	56
		C	30	30
		D	70	70
		E	44	44
	8樓至16樓、 18樓至39樓和 41樓至61樓 (46層)	A	63	2,898
		B	58	2,668
		C	31	1,426
		D	70	3,220
		E	47	2,162
	62樓 (1層)	A	68	68
		B	62	62
		C	33	33
		D	123	123

Summary of deed of mutual covenant

公契的摘要

C. 期數管理人的委任年期

遵從《建築物管理條例》，期數管理人的首屆任期由主公契的日期起計兩年，並於期滿後獲繼續任職直至根據主公契條款終止為止。

D. 管理開支按甚麼基準在期數中的住宅物業的擁有人之間分擔

1. 受制於主公契J章第5條 (b) (II) 和 (b) (III) 款，業主（大圍站擁有人和政府樓宇業主除外）須按下列方式分擔管理費：

- (i) 所有屋苑單位業主（財政司司長法團作為政府樓宇業主除外）須按他們擁有的單位獲分配的管理份數佔屋苑的總管理份數之比例分擔屋苑管理預算的開支。
- (ii) 住宅單位業主須按他們擁有的住宅單位獲分配的管理份數佔住宅發展項目的總管理份數之比例分擔住宅發展項目管理預算的開支。
- (iii) 住宅停車位業主須按他們擁有的住宅停車位獲分配的管理份數佔所有住宅停車位的總管理份數之比例分擔住宅停車場管理預算的開支，但是所有管理與保養公用電動車充電設施的開支僅由電動車停車位業主按他們各自的電動車停車位獲分配的管理份數佔所有電動車停車位的總管理份數之比例分擔。
- (iv) 受制於主公契C章第11條，地庫第3層商業停車位業主須按他們擁有的地庫第3層商業停車位獲分配的管理份數佔所有地庫第3層商業停車位的總管理份數之比例分擔地庫第3層商業停車場管理預算的開支，（細分管理份數給地庫第3層商業停車位則須按商業發展項目的副公契處理）。

但是，如果管理人對屋苑任何部分編製副預算或分副預算（上述預算以外），僅有歸屬該部分整體的開支須分攤。任何副預算或分副預算的開支須由該副預算或分副預算涵蓋的單位業主按他們擁有的單位獲分配的管理份數佔該副預算或分副預算涵蓋的屋苑有關部分的總管理份數之比例分擔。

2. 因為住宅停車場公用地方亦為屬於住宅公用地方的訪客停車位和單車停車位而設及享用，管理與保養住宅停車場公用地方的開支的7.532%，包括特別基金的住宅停車場賬戶的分擔款項，僅為供住宅單位的業主享用。據此，管理人將向所有住宅單位業主收取該等開支的上述百分比，使住宅單位業主須按他們擁有的住宅單位獲分配的管理份數佔尤其是所有住宅單位的總管理份數之比例分擔住宅停車場管理預算的費用及開支之7.532%。

3. 即使主公契有任何相反的規定，大圍站擁有人須分攤及分擔屋苑管理預算中歸屬管理與保養現有公廁項目、專上學院項目及公共運輸交匯處項目的費用及開支（但並非其他開支）和有關現有公廁項目、專上學院項目及公共運輸交匯處項目的資本性質或並非預期每年支出的主要工程之開支。大圍站擁有人和屋苑業主（政府樓宇業主除外）須按大圍站和屋苑各自的總樓面面積（政府樓宇的總樓面面積除外）佔發展項目的總樓面面積（政府樓宇的總樓面面積除外）之比例分擔屋苑管理預算中歸屬管理與保養現有公廁項目、專上學院項目及公共運輸交匯處項目的費用及開支和有關現有公廁項目、專上學院項目及公共運輸交匯處項目的資本性質或並非預期每年支出的主要工程之開支。據此，現有公廁項目、專上學院項目及公共運輸交匯處項目的該等費用及開支和有關現有公廁項目、專上學院項目及公共運輸交匯處項目的資本性質或並非預期每年支出的主要工程之開支的8.474%須由大圍站擁有人承擔，而上述費用、開支及支出餘下的91.526%須由屋苑業主（政府樓宇業主除外）承擔。

E. 計算管理費按金的基準

管理費按金金額相當於 3 個月的管理費。

F. 主公契中有關擁有人在期數中保留作自用的範圍（如有的話）的條文摘要

不適用。

備註：除非售樓說明書另行定義，否則本文所採用之詞彙與主公契所界定者具備相同涵義。

Summary of land grant

批地文件的摘要

1. The Phase is situated on Sha Tin Town Lot No.520 ("**the lot**").
2. The lot is held from the Government under New Grant No.22001 dated 26th January 2015 (as varied or modified by a Modification Letter dated 26th January 2017 and registered in the Land Registry by Memorial No.17022301530249) ("**the Land Grant**") for a term of 50 years from 26th January 2015 and expiring on 25th January 2065.

3. User

Special Condition No. (12)

- (a) Subject to these Conditions (as defined in General Condition No. 12(b) of the Land Grant) and in particular subject to Special Condition No. (28)(a) of the Land Grant, the lot or any part thereof or any building or part of any building erected or to be erected thereon shall not be used for any purpose other than for non-industrial (excluding godown, hotel and petrol filling station) purposes.
- (b) Without prejudice to the generality of sub-clause (a) of Special Condition No. (12) of the Land Grant, the lot or any part thereof or any building or part of any building erected or to be erected on the lot shall not be used for any purpose other than for which it is designed, constructed and intended to be used in accordance with these Conditions, the Approved Building Plans (as defined in Special Condition No. (10)(b)(i) of the Land Grant), the Approved Landscape Master Plan (as defined in Special Condition No. (14)(c) of the Land Grant) referred to in Special Condition No. (14) of the Land Grant and any master layout plan or plans approved by the Town Planning Board.

Special Condition No. (28)

- (a) The Grantee (as defined in General Condition No. 12(a) of the Land Grant) acknowledges that there is a railway station existing on the lot at the date of the Land Grant. The railway station together with such ancillary railway structures, facilities, subways and roads for the operation of railway (which railway station and ancillary railway structures, facilities, subways and roads are hereinafter collectively referred to as "**the Tai Wai Station**") shall not be used for any purpose other than for the purpose of a railway station and such purposes ancillary to the use, operation and management of the KCRC Railway ("**the KCRC Railway**") (for the avoidance of doubt excluding staff housing) and such other purposes as may be approved in writing by the Director of Lands ("**the Director**") who may in giving approval impose such terms and conditions as he thinks fit including the payment of premium.
- (b) Notwithstanding sub-clause (a) of Special Condition No. (28) of the Land Grant, the Grantee may use or permit or suffer the use of the Tai Wai Station or any part thereof for the provision of services or articles for the use or enjoyment of passengers on the railway.
- (c) The Grantee shall at his own expense use, operate and maintain in all respects to the satisfaction of the Director in accordance with these Conditions and the Approved Building Plans (if appropriate) the Tai Wai Station for the operation of the KCRC Railway.

4. Indemnity by Grantee

General Condition No. 4

The Grantee hereby indemnifies and shall keep indemnified the Government against all actions, proceedings, liabilities, demands, costs, expenses, losses (whether financial or otherwise) and claims whatsoever and howsoever arising from any breach of these Conditions or any damage or soil and groundwater contamination caused to adjacent or adjoining land or to the lot where such damage or soil and groundwater contamination has, in the opinion of the Director (and whose opinion shall be final and binding upon the Grantee), arisen out of any use of the lot, or any development or redevelopment of the lot or part thereof or out of any activities carried out on the lot or out of any other works carried out thereon by the Grantee whether or not such use, development or redevelopment, activities or works are in compliance with these Conditions or in breach thereof.

5. Maintenance

General Condition No. 6

- (a) The Grantee shall throughout the tenancy having built or rebuilt (which word refers to redevelopment as contemplated in sub-clause (b) below) in accordance with these Conditions:
 - (i) maintain all buildings in accordance with the approved design, disposition or height and any approved building plans without variation or modification thereto; and
 - (ii) maintain all buildings erected or which may after the date of the Land Grant be erected in accordance with these Conditions or any subsequent contractual variation of them, in good and substantial repair and condition and in such repair and condition deliver up the same at the expiration or sooner determination of the tenancy.
- (b) In the event of the demolition at any time during the tenancy of any building then standing on the lot or any part thereof the Grantee shall replace the same either by sound and substantial building or buildings of the same type and of no less gross floor area or by building or buildings of such type and value as shall be approved by the Director. In the event of demolition as aforesaid the Grantee shall within one calendar month of such demolition apply to the Director for consent to carry out building works for the redevelopment of the lot and upon receiving such consent shall within three calendar months thereof commence the necessary works of redevelopment and shall complete the same to the satisfaction of and within such time limit as is laid down by the Director.

Summary of land grant 批地文件的摘要

6. Private streets, roads and lanes

General Condition No. 8

Any private streets, roads and lanes which by these Conditions are required to be formed shall be sited to the satisfaction of the Director and included in or excluded from the area to be leased as may be determined by him and in either case shall be surrendered to the Government free of cost if so required. If the said streets, roads and lanes are surrendered to the Government, the surfacing, kerbing, draining (both foul and storm water sewers), channelling and road lighting thereof shall be carried out by the Government at the expense of the Grantee and thereafter they shall be maintained at public expense. If the said private streets, roads and lanes remain part of the area to be leased, they shall be lighted, surfaced, kerbed, drained, channelled and maintained by and at the expense of the Grantee in all respects to the satisfaction of the Director and the Director may carry out or cause to be carried out the installation and maintenance of road lighting for the sake of public interest as required. The Grantee shall bear the capital cost of installation of road lighting and allow free ingress and egress to and from the area to be leased to workmen and vehicles for the purpose of installation and maintenance of the road lighting.

7. Green Areas

Special Condition No. (5)(a)

The Grantee shall:

- (i) on or before the 30th day of September 2022, or such other date or dates as may be approved by the Director, at his own expense, in such manner with such materials and to such standards, levels, alignment and design as the Director shall approve and in all respects to the satisfaction of the Director:
 - (I) lay and form those portions of future public roads shown coloured green on the plan annexed to the Land Grant ("**the Green Areas**"); and
 - (II) provide and construct such bridges, tunnels, over-passes, under-passes, culverts, viaducts, flyovers, pavements, roads or such other structures as the Director in his sole discretion may require ("**the Structures**")

so that building, vehicular, pedestrian and cyclist traffic may be carried on the Green Areas;

- (ii) on or before the 30th day of September 2022, or such other date or dates as may be approved by the Director, at his own expense and to the satisfaction of the Director, surface, kerb and channel the Green Areas and provide the same with such gullies, sewers, drains, fire hydrants with pipes connected to water mains, services street lights, traffic signs, street furniture, road markings and plant as the Director may require; and
- (iii) maintain at his own expense the Green Areas together with the Structures and all structures, surfaces, gullies, sewers, drains, fire hydrants, services, street lights, traffic signs, street furniture, road markings and plant constructed, installed and provided thereon or therein to the satisfaction of the Director until such time as possession of the Green Areas has been re-delivered to the Government by the Grantee in accordance with Special Condition No. (6) of the Land Grant.

Special Condition No. (6)

For the purpose only of carrying out the necessary works specified in Special Condition No.(5) of the Land Grant, the Grantee shall on the date of the Land Grant be granted possession of the Green Areas. The Green Areas or any part or parts thereof shall be re-delivered to the Government on demand and in any event the Green Areas shall be deemed to have been re-delivered to the Government by the Grantee on the date of a letter from the Director indicating that these Conditions have been complied with to his satisfaction. The Grantee shall at all reasonable times while he is in possession of the Green Areas or any part or parts thereof allow free access over and along the Green Areas or such part or parts thereof for all Government and public vehicular, pedestrian and cyclist traffic and shall ensure that such access shall not be interfered with or obstructed by the carrying out of the works whether under Special Condition No. (5) of the Land Grant or otherwise.

Special Condition No. (7)

The Grantee shall not without the prior written consent of the Director use the Green Areas for the purpose of storage or for the erection of any temporary structure or for any purposes other than the carrying out of the works specified in Special Condition No. (5) of the Land Grant.

8. Building covenant

Special Condition No. (11)

The Grantee shall develop the lot by the erection thereon of a building or buildings complying in all respects with these Conditions and all Ordinances, bye-laws and regulations relating to building, sanitation and planning which are or may at any time be in force in Hong Kong, such building or buildings (other than the PSC (as defined in Special Condition No. (22)(a)(i) of the Land Grant)) to be completed and made fit for occupation on or before the 30th day of September, 2022.

9. Preservation of trees

Special Condition No. (13)

No tree growing on the lot or adjacent thereto shall be removed or interfered with without the prior written consent of the Director who may, in granting consent, impose such conditions as to transplanting, compensatory landscaping or replanting as he may deem appropriate.

10 Landscaping

Special Condition No. (14)

- (b) (ii) Not less than 30% of the area of the lot shall be planted with trees, shrubs or other plants.
- (iii) Not less than 50% or such other percentage as may be approved by the Director of the 30% referred to in sub-clause (b)(ii) of Special Condition No. (14) of the Land Grant ("**the Greenery Area**") shall be provided at such location or level as may be determined by the Director at his sole discretion so that the Greenery Area shall be visible to pedestrians or accessible by any person or persons entering the lot.

Summary of land grant

批地文件的摘要

(c) The Grantee shall at his own expense landscape the lot in accordance with the approved landscape master plan ("**the Approved Landscape Master Plan**") in all respects to the satisfaction of the Director and no amendment, variation, alteration, modification or substitution of the Approved Landscape Master Plan shall be made without the prior written consent of the Director.

(d) The Grantee shall thereafter at his own expense keep and maintain the landscaped works in a safe, clean, neat, tidy and healthy condition all to the satisfaction of the Director.

11. Development conditions

Special Condition No. (15)

Subject to these Conditions, upon development or redevelopment (which term refers solely to redevelopment contemplated in General Condition No. 6 of the Land Grant) of the lot or any part thereof:

(a) the Grantee shall only erect, construct, provide and maintain upon the lot the following accommodation and facilities for:

- (i) the Tai Wai Station (as defined in Special Condition No. (28)(a) of the Land Grant);
- (ii) (I) private residential purpose ("**the Residential Accommodation**") with a total gross floor area of not less than 114,288 square metres and not more than 190,480 square metres;
- (II) non-industrial (excluding private residential, godown, hotel and petrol filling station) purposes ("**the Other Accommodation**") (including the Bicycle Park (as defined in Special Condition No. (20)(a) of the Land Grant) and the Cycle Track (as defined in Special Condition No. (21)(a) of the Land Grant)) with a total gross floor area of not less than 37,200 square metres and not more than 62,000 square metres;
- (III) the Existing Public Toilet (as defined in Special Condition No. (16)(a) of the Land Grant);
- (IV) the Existing PTI (as defined in Special Condition No. (17)(a) of the Land Grant) and the New PTI (as defined in Special Condition No. (18)(a)(i) of the Land Grant);
- (V) the Bicycle Park (as defined in Special Condition No. (20)(a) of the Land Grant) and the Cycle Track (as defined in Special Condition No. (21)(a) of the Land Grant) with a total gross floor area of not less than 1,380 square metres; and
- (VI) the PSC (as defined in Special Condition No. (22)(a)(i) of the Land Grant) with a total gross floor area of 15,000 square metres;

(d) the total gross floor area of any building or buildings erected or to be erected on the lot shall not be less than 166,488 square metres and shall not exceed 267,480 square metres (it being agreed and acknowledged by the Grantee that there is no guarantee by the Government that the building or buildings erected or to be erected on the lot or any part thereof can attain the maximum gross floor areas referred to in sub-clauses (a)(ii)(I), (a)(ii)(II) and (d) of Special Condition No. (15) of the Land Grant);

(e) no part of any building or other structure erected or to be erected on the lot together with any addition or fitting (if any) to such building or structure may in the aggregate exceed a height of 199.8 metres above the Hong Kong Principal Datum or such other height limit as the Director at his sole discretion may, subject to the payment by the Grantee of any premium and administrative fee as shall be determined by the Director, approve provided that with the prior written approval of the Director, machine rooms, air-conditioning units, water tanks, stairhoods, antenna and telecommunication service equipment, lightning protection facilities, building maintenance plant and similar structures and facilities, excluding communal sky garden, may be erected or placed on the roof of the building or buildings so as to exceed the above height limit;

(f) (i) except with the prior written approval of the Director, any building or group of buildings erected or to be erected on the lot shall not have any projected facade length of 60 metres or more.

12. Existing Public Toilet

Special Condition No. (16)

(a) The Grantee acknowledges that there is a public toilet with a net operational floor area of not less than 71.3 square metres on the ground level of the lot (which accommodation (including lighting fixtures, ventilation plant, extract ductworks and road or floor surfaces but excluding such lifts, escalators, stairways, plant, equipment and other facilities not serving exclusively thereto as may be permitted by the Director in accordance with these Conditions, walls, columns, beams, ceilings, roof slabs, carriageway or floor slabs and any other structural elements) together with any other areas, facilities, services and installations exclusive thereto as the Director may in his absolute discretion determine (whose determination shall be conclusive and binding on the Grantee) is hereinafter referred to as "**the Existing Public Toilet**"). The Government will accept no responsibility or liability for any loss, damage, nuisance or disturbance whatsoever caused to or suffered by the Grantee by reason of the presence, operation and use of the Existing Public Toilet.

(b) The Grantee shall not interfere with the normal operation of the Existing Public Toilet. No building works which may affect the normal operation of the Existing Public Toilet shall be carried out except with the prior written approval of the Director of Food and Environmental Hygiene.

(c) The Government hereby reserves the right to alter or vary in its absolute discretion at any time the use of the Existing Public Toilet or any part thereof.

(e) (i) The Grantee shall at all times throughout the term agreed to be granted by the Land Grant permit all members of the public for all lawful purposes freely and without payment of any nature whatsoever to enter into, upon and through such part or parts of the lot and in, under, through, on or over any buildings, structures and erection thereon designated by the Grantee to the satisfaction of the Director of Food and Environmental Hygiene for the purpose of unobstructed access to and from the Existing Public Toilet and the adjacent public road.

(g) Upon possession of the lot being given to and taken by the Grantee in accordance with Special Condition No. (3) of the Land Grant, possession of the Existing Public Toilet shall be deemed to be delivered by the Grantee to the Government for its exclusive use, occupation and operation.

Summary of land grant

批地文件的摘要

- (i) (i) The Grantee shall throughout the term agreed to be granted by the Land Grant at his own expense and in all respects to the satisfaction of the Director maintain the following items ("**the Existing Public Toilet Items**"):
- (I) the external finishes of the Existing Public Toilet and the structure of all walls, columns, beams, ceilings, roof slabs, carriageway or floor slabs and any other structural elements of, in, around, within, above and below the Existing Public Toilet;
 - (II) all lifts, escalators and stairways serving the Existing Public Toilet and the remainder of the development on the lot;
 - (III) all building services installations, plant and equipment (including but not limited to portable and non-portable fire services installation equipment) forming part of the system serving the Existing Public Toilet and the remainder of the development on the lot;
 - (IV) all of the structural slabs under the Existing Public Toilet together with the drainage systems therein and thereunder; and
 - (V) all other common parts and facilities serving the Existing Public Toilet and the remainder of the development on the lot.
- (ii) The Grantee shall indemnify and keep indemnified the Government and F.S.I. (as defined in Special Condition No. (16)(h)(i) of the Land Grant) against all liabilities, damages, expenses, claims, costs, demands, charges, actions and proceedings of whatsoever nature arising out of or as a consequence of the failure of the Grantee to maintain the Existing Public Toilet Items.
- (iii) For the purpose of this sub-clause (i), the expression "**Grantee**" shall exclude F.S.I.

13. The Existing PTI

Special Condition No. (17)

- (a) The Grantee acknowledges that there is a public transport interchange on the ground level of the lot (which accommodation (including lighting fixtures, ventilation plant, extract ductworks and road or floor surfaces but excluding such lifts, escalators, stairways, plant, equipment and other facilities not serving exclusively thereto as may be permitted by the Director in accordance with these Conditions, walls, columns, beams, ceilings, roof slabs, carriageway or floor slabs and any other structural elements) together with any other areas, facilities, services and installations exclusive thereto as the Director may in his absolute discretion determine (whose determination shall be conclusive and binding on the Grantee) is hereinafter referred to as "**the Existing PTI**"). The Government will accept no responsibility or liability for any loss, damage, nuisance or disturbance whatsoever caused to or suffered by the Grantee by reason of the presence, operation and use of the Existing PTI and the Grantee hereby indemnifies and shall keep indemnified the Government from and against all liabilities, claims, costs, demands, actions or other proceedings whatsoever arising whether directly or indirectly out of or in connection with anything done or omitted to be done by the Grantee, his servants, workmen and contractors in the Existing PTI.

- (b) Upon possession of the lot being given to and taken by the Grantee in accordance with Special Condition No. (3) of the Land Grant, possession of the Existing PTI shall be deemed to be delivered by the Grantee to the Government for its exclusive use, occupation and operation, but without prejudice to any agreement made between the Government and the Grantee on the maintenance of the Existing PTI, until the re-delivery of possession of the Existing PTI to the Grantee in accordance with sub-clause (g) of Special Condition No. (17) of the Land Grant.
- (c) The Grantee shall permit the public to use the Existing PTI and shall not interfere with the normal operation of the Existing PTI. No building works which may affect the normal operation of the Existing PTI shall be carried out except with the prior written approval of the Commissioner for Transport.
- (d) (i) There is reserved unto the Government, its officers, agents, contractors, workmen and other duly authorized personnel free of all costs and charges all the necessary rights of ingress, egress and regress to, from and through the lot or any part or parts thereof for the purposes of inspecting, checking and supervising any works required to be carried out by the Grantee in accordance with Special Condition No. (18)(a) of the Land Grant and carrying out any works by the Government which the Director may consider necessary in the Existing PTI.
- (ii) The Government, its officers, agents, contractors, workmen and other duly authorized personnel shall have no liability in respect of any loss, damage, nuisance or disturbance whatsoever caused to or suffered by the Grantee arising out of or incidental to the exercise by it or them of the rights conferred under sub-clause (d)(i) of Special Condition No. (17) of the Land Grant and no claim shall be made against it or them by the Grantee in respect of such loss, damage, nuisance or disturbance.
- (e) The Government shall have the absolute discretion at any time to determine on the public use of the Existing PTI or any part thereof during which the Existing PTI is in the possession of the Government.
- (f) (i) The Grantee shall allow unrestricted and free access to and from the Existing PTI through the lot or any part thereof for all Government and public vehicular and pedestrian traffic and the Government shall have the absolute right in exercising its power under the Road Traffic Ordinance and the Public Bus Services Ordinance, any regulations made thereunder and any amending legislation.
- (g) The possession of the Existing PTI shall be deemed to be redelivered to the Grantee immediately prior to the delivery, upon demand by the Director, of vacant possession of the New PTI (as defined in Special Condition No. (18)(a)(i) of the Land Grant) to the Government in accordance with Special Condition No. (18)(l) of the Land Grant or the assignment of the New PTI to F.S.I. pursuant to Special Condition No. (18)(i) of the Land Grant, whichever is the earlier.

Summary of land grant

批地文件的摘要

14. Provision of the New PTI

Special Condition No. (18)

- (a) (i) The Grantee shall at his own expense and in all respects to the satisfaction of the Director design, erect, construct and provide (including conducting all necessary works and modification works to the Existing PTI and any other works which the Commissioner for Transport may consider necessary) in a good workmanlike manner and in accordance with these Conditions and the plans approved under sub-clause (d) of Special Condition No. (18) of the Land Grant one public transport interchange located or to be located at the ground level of the lot comprising a bus terminus with seven sawtooth bus bays, one parallel bus bay and six parallel bus stacking spaces, four parallel green minibus bays, one parallel general loading and unloading bay, two public loading and unloading bays and one taxi lay-by or such other numbers or facilities as may be required or approved by the Commissioner for Transport and an area with a net operational floor area of not less than 45 square metres reserved for ancillary facilities for bus operator, with access connecting with public roads and provision of ancillary facilities, to be completed and made fit for occupation and operation on or before 30th day of September, 2022 or such other later date as may be determined by the Director (whose determination shall be final and binding on the Grantee) (which accommodation (including lighting fixtures, ventilation plant, extract ductworks and road or floor surfaces but excluding such lifts, escalators, stairways, plant, equipment and other facilities not serving exclusively thereto as may be permitted by the Director in accordance with these Conditions, walls, columns, beams, ceilings, roof slabs, carriageway or floor slabs and any other structural elements) together with any other areas, facilities, services and installations exclusive thereto as the Director may in his absolute discretion determine (whose determination shall be conclusive and binding on the Grantee) is hereinafter referred to as "**the New PTI**").
- (ii) The Grantee is by the Land Grant granted with the right of access to and from the Existing PTI or any part thereof to:
- (I) conduct the works or modification works for the purpose of constructing and completing the New PTI pursuant to sub-clause (a)(i) of Special Condition No. (18) of the Land Grant;
- (II) carry out any other works which the Commissioner for Transport may consider necessary pursuant to sub-clause (a)(i) of Special Condition No. (18) of the Land Grant; and
- (III) carry out the maintenance works of the Existing PTI pursuant to Special Condition No. (19)(a) of the Land Grant and any agreement made between the Government and the Grantee on the maintenance of the Existing PTI during such period of construction of the New PTI;
- (iii) The Grantee hereby indemnifies and shall keep indemnified the Government from and against all liabilities, damages, expenses, claims, costs, demands, charges, actions and proceedings of whatsoever nature arising whether directly or indirectly out of or in connection with anything done or omitted to be done by the Grantee, his servants, workmen and contractors in connection with the provision and construction of the New PTI.

- (b) The Government hereby reserves the right to alter or vary in its absolute discretion at any time the use of the New PTI or any part thereof.
- (j) (i) The Grantee shall indemnify and keep indemnified the Government and F.S.I. against all claims, costs, demands, charges, damages, actions and proceedings of whatsoever nature arising out of or in connection with any defects, wants of repair, imperfections, breakdown, faults or any other outstanding works (whether in respect of workmanship, material, design or otherwise) in the New PTI and in the building services installations therefor (except for those building services installations, structures, facilities and buildings which are in existence in the Existing PTI at the date of the Land Grant but have not been modified or amended by the Grantee pursuant to sub-clause (a)(i) of Special Condition No. (18) of the Land Grant)
- (I) which may exist at the date of delivery of possession by the Grantee of the New PTI to the Government in accordance with sub-clause (I) of Special Condition No. (18) of the Land Grant; and
- (II) which shall occur or become apparent within a period of 365 days after the date of delivery of possession by the Grantee of the New PTI to the Government in accordance with sub-clause (I) of Special Condition No. (18) of the Land Grant ("**Defects Liability Period of the New PTI**").
- (ii) Whenever required by the Director or F.S.I. or both, the Grantee shall at his own expense and within such time and to such standard and in such manner as may be specified by the Director or F.S.I. or both carry out all works of maintenance, repair, amendment, reconstruction and rectification and any other works as may be necessary to remedy and rectify any defects, wants of repair, imperfections, breakdown, faults or any other outstanding works in the New PTI and the building services installations therefor (except for those building services installations, structures, facilities and buildings which are in existence in the Existing PTI at the date of the Land Grant but have not been modified or amended by the Grantee pursuant to sub-clause (a)(i) of Special Condition No. (18) of the Land Grant) which shall occur or become apparent within any Defects Liability Period of the New PTI. In addition to the foregoing, the Grantee shall at his own expense and within such time and to such standard and in such manner as may be specified by the Director or F.S.I. or both make good and rectify any defects, wants of repair, imperfections, breakdown, faults or any other outstanding works in the New PTI and the building services installations therefor (except for those building services installation, structures, facilities and buildings which are in existence in the Existing PTI at the date of the Land Grant but have not been modified or amended by the Grantee pursuant to sub-clause (a)(i) of Special Condition No. (18) of the Land Grant) which may exist at the date of delivery of possession thereof by the Grantee.

Summary of land grant

批地文件的摘要

- (iii) The Director or F.S.I. or both will, shortly before the expiry of the Defects Liability Period of the New PTI, cause an inspection to be carried out in respect of the New PTI and the building services installations therefor (except for those building services installation, structures, facilities and buildings which are in existence in the Existing PTI at the date of the Land Grant but have not been modified or amended by the Grantee pursuant to sub-clause (a)(i) of Special Condition No. (18) of the Land Grant) for the purpose of identifying any defects, wants of repair, imperfections, breakdown, faults or any other outstanding works which may be evident. The Director and F.S.I. reserve the right to each of them to serve upon the Grantee within 14 days after the expiry of the Defects Liability Period of the New PTI a schedule or schedules of defects specifying any defects, wants of repair, imperfections, breakdown, faults or any other outstanding works which may be evident in the New PTI and the building services installations therefor (except for those building services installations, structures, facilities and buildings which are in existence in the Existing PTI at the date of the Land Grant but have not been modified or amended by the Grantee pursuant to sub-clause (a)(i) of Special Condition No. (18) of the Land Grant) and the Grantee shall at his own expense cause all necessary works to be carried out so as to remedy and rectify the same within such time and to such standard and in such manner as may be specified by the Director or F.S.I. or both.
- (vi) For the purpose of this sub-clause (j), the expression "**Grantee**" shall exclude his assigns.
- (m) (i) Without prejudice to the provisions of sub-clause (j) of Special Condition No. (18) of the Land Grant the Grantee shall, at all times until expiry of the Defects Liability Period of the New PTI, at his own expense maintain in good condition and in all respects to the satisfaction of the Director the New PTI and the building services installations therefor (except for those building services installation, structures, facilities and buildings which are in existence in the Existing PTI at the date of the Land Grant but have not been modified or amended by the Grantee pursuant to sub-clause (a)(i) of Special Condition No. (18) of the Land Grant).
- (ii) For the purpose of sub-clause (m)(i) of Special Condition No. (18) of the Land Grant, the expression "**Grantee**" shall exclude his assigns.
- (n) (i) There is reserved unto the Government, its officers, agents, contractors, workmen and other duly authorized personnel free of all costs and charges all the necessary rights of ingress, egress and regress to, from and through the lot or any part or parts thereof and the New PTI (while the Grantee is in possession of the New PTI) for the purposes of inspecting, checking and supervising any works required to be carried out by the Grantee in the New PTI.
- (o) Before the delivery, upon demand by the Director, of vacant possession of the New PTI to the Government in accordance with sub-clause (l) of Special Condition No. (18) of the Land Grant or the assignment of the New PTI to F.S.I. pursuant to sub-clause (i) of Special Condition No. (18) of the Land Grant, whichever is the earlier, the Government and F.S.I. shall have a right to have an emergency evacuation access ("**the EVA**") through a designated area (to be agreed by the Director and the Grantee) within the New PTI. The Grantee shall at his own expense register the plan showing the EVA, which plan shall have been approved by the Director, at the Land Registry.
- (q) (i) The Grantee shall at all times allow unrestricted and free access to and from the New PTI through the lot or any part thereof for all Government and public vehicular and pedestrian traffic.
15. **Maintenance of external finishes and structure of walls, etc. of the Existing PTI and the New PTI**
Special Condition No. (19)
- (a) The Grantee shall throughout the term agreed to be granted by the Land Grant at his own expense and in all respects to the satisfaction of the Director maintain the following items ("**the PTI Items**"):
- (i) the external finishes of the Existing PTI and the New PTI and the structure of all walls, columns, beams, ceilings, roof slabs, carriageway or floor slabs and any other structural elements of, in, around, within, above and below the Existing PTI and the New PTI;
- (ii) all lifts, escalators and stairways serving the Existing PTI or the New PTI or both and the remainder of the development on the lot;
- (iii) all building services installations, plant and equipment (including but not limited to portable and non-portable fire services installation equipment) forming part of the system serving the Existing PTI or the New PTI or both and the remainder of the development on the lot;
- (iv) all of the structural slabs under the Existing PTI or the New PTI or both together with the drainage systems therein and thereunder; and
- (v) all other common parts and facilities serving the Existing PTI or the New PTI or both and the remainder of the development on the lot.
- (c) For the purpose of Special Condition No. (19) of the Land Grant, the expression "**Grantee**" shall exclude F.S.I.
16. **Provision of the Bicycle Park**
Special Condition No. (20)
- (a) The Grantee shall on or before 30th day of September, 2022 or within such time limit as may be specified and subject to such conditions as may be approved by the Director at his own expense and in all respects to the satisfaction of the Director erect and construct in a good workmanlike manner and thereafter maintain and manage a bicycle park which shall comprise 330 spaces or such other number as may be approved by the Director and shall be located in close proximity to the New PTI or at such other location as may be determined by the Director for the parking of bicycles of the public ("**the Bicycle Park**"). The Grantee shall submit or cause to be submitted to the Commissioner for Transport detailed design proposal for his written approval prior to commencement of works.
- (c) The Grantee shall throughout the term agreed to be granted by the Land Grant keep the Bicycle Park open for use by the public 24 hours a day except for the period during which the Bicycle Park or any part or parts thereof shall have to be closed temporarily for the purpose of carrying out maintenance works.
- (g) For the purpose of Special Condition No. (20) of the Land Grant, the expression "**Grantee**" shall exclude F.S.I.

Summary of land grant 批地文件的摘要

17. Provision of Cycle Track

Special Condition No. (21)

- (a) The Grantee shall on or before 30th day of September, 2022 or within such time limit as may be specified and subject to such conditions as may be approved by the Director at his own expense and in all respects to the satisfaction of the Director provide and thereafter maintain and manage a cycle track with a clear width of not less than 3.5 metres ("**the Cycle Track**") so as to link up the Bicycle Park and the adjacent cycle tracks and to ensure continuity of the cycle track network of the Sha Tin New Town.
- (e) The Grantee shall throughout the term agreed to be granted by the Land Grant keep the Cycle Track open 24 hours a day free of charge for the passing and repassing of cyclists (whether riding on the cycles or not) without any interruption.
- (i) For the purpose of Special Condition No. (21) of the Land Grant, the expression "**Grantee**" shall exclude F.S.I.

18. Provision of the PSC

Special Condition No. (22)

- (a) (i) The Grantee shall at his own expense and in all respects to the satisfaction of the Secretary for Education design, erect, construct and provide within the lot in a good workmanlike manner and in accordance with these Conditions, the plans approved under sub-clause (c) of Special Condition No. (22) of the Land Grant and the specifications to be agreed upon by the Secretary for Education and the Grantee ("**the Specifications**"), one post secondary college with a total gross floor area of 15,000 square metres together with eight motor vehicles parking spaces and five motor cycle parking spaces as stipulated respectively in Special Condition Nos. (43) (c) and (43)(e)(i)(III) of the Land Grant (collectively, "**the PSC**").
 - (ii) The Grantee shall complete the structural shell and the external façade of the PSC together with eight motor vehicles parking spaces and five motor cycle parking spaces on or before 31st day of March, 2020 or such later date as may be agreed by the Secretary for Education and the Grantee.
 - (iii) Notwithstanding sub-clause (a)(i) of Special Condition No. (22) of the Land Grant, if the Grantee shall fail to agree with the Secretary for Education on the Specifications within 36 calendar months from the date of the Land Grant, the Grantee shall forthwith at his own expense and in all respects to the satisfaction of the Secretary for Education, on or before the time limit specified in sub-clause (a)(ii) of Special Condition No. (22) of the Land Grant, construct and provide the PSC within the lot in a good workmanlike manner and in accordance with the design and layout (including any subsequent amendments) approved or to be approved by the Secretary for Education.
 - (iv) The Grantee shall at his own expense maintain and manage the PSC and everything thereon, therein or thereunder in good condition and to the satisfaction of the Director until such time as possession of the PSC has been delivered to the Government in accordance with sub-clause (m) of Special Condition No. (22) of the Land Grant or the PSC has been assigned to the F.S.I. pursuant to sub-clause (h) of Special Condition No. (22) of the Land Grant, whichever is the earlier.
- (b) The Government hereby reserves the right to alter or vary in its absolute discretion at any time the use of the PSC or any part thereof.

- (i) (i) The Grantee shall indemnify and keep indemnified the Government and F.S.I. against all claims, costs, demands, charges, damages, actions and proceedings of whatsoever nature arising out of or in connection with any defects, wants of repair, imperfections, breakdown, faults or any other outstanding works (whether in respect of workmanship, material, design or otherwise) in the PSC:
 - (I) which may exist at the date of delivery of possession by the Grantee of the PSC to the Government in accordance with sub-clause (m) of Special Condition No. (22) of the Land Grant; and
 - (II) which shall occur or become apparent within a period of 365 days after the date of delivery of possession by the Grantee of the PSC to the Government in accordance with sub-clause (m) of Special Condition No. (22) of the Land Grant ("**Defects Liability Period of the PSC**").
- (ii) Whenever required by the Director or F.S.I. or both, the Grantee shall at his own expense and within such time and to such standard and in such manner as may be specified by the Director or F.S.I. or both carry out all works of maintenance, repair, amendment, reconstruction and rectification and any other works as may be necessary to remedy and rectify any defects, wants of repair, imperfections, breakdown, faults or any other outstanding works in the PSC which shall occur or become apparent within any Defects Liability Period of the PSC. In addition to the foregoing, the Grantee shall at his own expense and within such time and to such standard and in such manner as may be specified by the Director or F.S.I. or both make good and rectify any defects, wants of repair, imperfections, breakdown, faults or any other outstanding works in the PSC which may exist at the date of delivery of possession thereof by the Grantee.
- (iii) The Director or F.S.I. or both will, shortly before the expiry of the Defects Liability Period of the PSC, cause an inspection to be carried out in respect of the PSC for the purpose of identifying any defects, wants of repair, imperfections, breakdown, faults or any other outstanding works which may be evident. The Director and F.S.I. reserve the right to each of them to serve upon the Grantee within 30 days after the expiry of the Defects Liability Period of the PSC a schedule or schedules of defects specifying any defects, wants of repair, imperfections, breakdown, faults or any other outstanding works which may be evident in the PSC and the Grantee shall at his own expense cause all necessary works to be carried out so as to remedy and rectify the same within such time and to such standard and in such manner as may be specified by the Director or F.S.I. or both.
- (vi) For the purpose of this sub-clause (i), the expression "**Grantee**" shall exclude his assigns.
- (k) (i) Without prejudice to the provisions of sub-clause (i) of Special Condition No. (22) of the Land Grant, the Grantee shall, at all times until expiry of the Defects Liability Period of the PSC, at his own expense maintain in good condition and in all respects to the satisfaction of the Director the PSC.
- (ii) For the purpose of sub-clause (k)(i) of Special Condition No. (22) of the Land Grant, the expression "**Grantee**" shall exclude his assigns.
- (l) (i) The Grantee shall throughout the term agreed to be granted by the Land Grant at his own expense and in all respects to the satisfaction of the Director maintain the following items ("**the PSC Items**");

Summary of land grant

批地文件的摘要

- (I) the external finishes and the external façade of the PSC and the structure of all walls, columns, beams, ceilings, roof slabs, carriageway or floor slabs and any other structural elements of, in, around, within, above and below the PSC;
 - (II) all lifts, escalators and stairways serving the PSC and the remainder of the development on the lot;
 - (III) all building services installations, plant and equipment (including but not limited to portable and non-portable fire services installation equipment) forming part of the system serving the PSC and the remainder of the development on the lot;
 - (IV) all of the structural slabs under the PSC together with the drainage systems therein and thereunder; and
 - (V) all other common parts and facilities serving the PSC and the remainder of the development on the lot.
- (ii) The Grantee shall indemnify and keep indemnified the Government and F.S.I. against all liabilities, damages, expenses, claims, costs, demands, charges, actions and proceedings of whatsoever nature arising out of or as a consequence of the failure of the Grantee to maintain the PSC Items.
- (iii) For the purpose of this sub-clause (I), the expression "**Grantee**" shall exclude F.S.I.

19. Provision of sales office and show flats

Special Condition No. (23)

Notwithstanding the maximum gross floor area permitted under Special Condition Nos. (15)(a)(ii) and (15)(d) of the Land Grant, the Grantee may erect on part or parts of the lot separate temporary structures for the purposes of a sales office and show flats and related marketing activities to facilitate the sale of the building or buildings or any part or parts thereof erected or to be erected on the lot in accordance with these Conditions, provided that the scale and period of operation of such sales office and show flats and related marketing activities shall be subject to the prior written approval of the Director.

20. Recreational facilities

Special Condition No. (24)(a)

- (i) The Grantee may erect, construct and provide within the lot such recreational facilities and facilities ancillary thereto ("**the Facilities**") as may be approved in writing by the Director. The type, size, design, height and disposition of the Facilities shall also be subject to the prior written approval of the Director.
- (iii) In the event that any part of the Facilities is exempted from the gross floor area calculation pursuant to sub-clause (a)(ii) of Special Condition No. (24) of the Land Grant ("**the Exempted Facilities**"):
 - (I) the Exempted Facilities shall be designated as and form part of the Common Areas referred to in Special Condition No. (40)(a)(v) of the Land Grant;
 - (II) the Grantee shall at his own expense maintain the Exempted Facilities in good and substantial repair and condition and shall operate the Exempted Facilities to the satisfaction of the Director; and

- (III) the Exempted Facilities shall only be used by the residents of the residential block or blocks erected or to be erected within the lot and their bona fide visitors and by no other person or persons.

21. Open space

Special Condition No. (24)(b)

- (i) The Grantee shall at his own expense and in all respects to the satisfaction of the Director provide an open space within the lot with a total area of not less than 8,500 square metres or such other area as may be approved in writing by the Director ("**the Open Space**") which shall be located, formed, serviced, landscaped, planted, treated and provided with such equipment and facilities as the Director may require or approve.
- (ii) The Open Space shall not be used for any purpose other than for recreational purposes for the proper use and enjoyment of the lot by the residents of the building or buildings erected or to be erected on the lot and their bona fide guests or visitors.
- (iii) The Grantee shall throughout the term agreed to be granted by the Land Grant at his own expense maintain the Open Space in good and substantial repair and condition in all respects to the satisfaction of the Director.
- (iv) The Open Space shall be designated as and form part of the Common Areas referred to in Special Condition No. (40)(a)(v) of the Land Grant.

22. Railway Structures and Installations protection

Special Condition No. (32)

- (a) Prior to the commencement of any works whatsoever on the lot including but not limited to site investigation works, piling or other foundation works and other civil engineering and building works, the Grantee shall consult MTRCL (as defined in Special Condition No. (29)(c) of the Land Grant) so as to ensure that any such works do not damage, interfere with, obstruct or endanger the safety or the operation of the KCRC Railway and the Tai Wai Station or any railway works, structures, facilities or installations in relation to the KCRC Railway (which Tai Wai Station, railway works, structures, facilities and installations are hereinafter collectively referred to as "**the Railway Structures and Installations**") in or passing through or in the vicinity of the lot or any part thereof (as to which the decision of the Director shall be conclusive). If required by the Director the Grantee shall at his own expense take such measures and precautions as may be required by the MTRCL to ensure the safety and the operation of the KCRC Railway and the Railway Structures and Installations.
- (b) The Grantee shall comply with all Ordinances, by-laws and regulations relating to the KCRC Railway and the Railway Structures and Installations.
- (c) The Grantee shall not interfere in any way with the construction, use and operation of the KCRC Railway and the Railway Structures and Installations.
- (d) The Grantee shall at his own expense comply with all special requirements of the Building Authority, the Director of Fire Services and all other relevant Government and statutory authorities in connection with the construction (including the materials to be used), repair and maintenance of any part or parts of the building or buildings connected or in close proximity to the KCRC Railway and the Railway Structures and Installations.

Summary of land grant

批地文件的摘要

- (e) Throughout the term agreed to be granted by the Land Grant, the Grantee shall comply with and observe to the satisfaction of the Director of Buildings all the requirements imposed by the Director of Buildings from time to time to protect the KCRC Railway and the Railway Structures and Installations.
- (f) Subject to sub-clause (g) of Special Condition No. (32) of the Land Grant, in the event MTRCL ceases to operate the KCRC Railway or any part of the KCRC Railway affecting the lot upon the revocation or expiration of the franchise (including any extension thereto) granted under Section 4 of the Ordinance (as defined in Special Condition No. (29)(c)(iv)(I)(B) of the Land Grant) or the termination or expiry of the Service Concession Agreement (as defined in Special Condition No. (29)(c) of the Land Grant), any reference to MTRCL in Special Condition No. (32) of the Land Grant shall mean the Kowloon-Canton Railway Corporation.
- (g) In the event MTRCL ceases to operate the KCRC Railway or any part of the KCRC Railway affecting the lot upon the revocation or expiration of the franchise (including any extension thereto) granted under Section 4 of the Ordinance and the Government, its nominee or a third party designated by the Government takes possession of the KCRC Railway or such part of the KCRC Railway affecting the lot pursuant to Section 19A(2) of the Ordinance, any reference to MTRCL in Special Condition No. (32) of the Land Grant shall where appropriate mean the Government, its nominee or a third party designated by the Government.

23. Access to the Tai Wai Station by the Government

Special Condition No. (33)(a)

The Grantee shall throughout the term agreed to be granted by the Land Grant permit the Government, its officers, servants and agents and any other persons authorized by it or them the right of free ingress, egress and regress to, from and through the lot and any buildings or structures erected or to be erected thereon at all reasonable times (upon giving not less than 14 days' prior notice except in case of emergency) with or without tools, motor vehicles or equipment for the purposes of inspection of the Railway Structures and Installations and public roads and highways structures or any part thereof.

24. Access to the Tai Wai Station by the public

Special Condition No. (34)

The Grantee shall throughout the term agreed to be granted by the Land Grant permit all members of the public on foot or by wheelchairs or with all types of vehicles (if appropriate) during the operational hours of the Tai Wai Station for all lawful purposes freely and without payment of any nature whatsoever to enter into, upon and through such part or parts of the lot and in, under, through, on or over any buildings, structures and erection thereon designated by the Grantee for the purposes of access to and from the Tai Wai Station.

25. Construction of Covered Footbridges

Special Condition No. (35)

- (a) The Grantee shall on or before 30th day of September 2022 or within such time limit as may be specified and subject to such conditions as may be approved by the Director at the Grantee's own expense and in all respects to the satisfaction of the Director:
 - (i) erect, construct and provide two single-storey covered footbridges together with all supports and connections (including any supports and connections which the Director in his absolute discretion considers necessary for any future extension to the covered footbridges) as shall be required or approved by the Director (collectively, "**the Covered Footbridges**") in the approximate positions shown and marked "**PROPOSED FB 1**" and "**PROPOSED FB 2**" on the plan annexed to the Land Grant so that pedestrian access can be gained over the Covered Footbridges to and from the Pedestrian Link (as defined in Special Condition No. (36)(a) of the Land Grant). The Covered Footbridges shall be constructed with such materials and to such standards, levels, alignment, disposition and designs as shall be required and approved by the Director including but not limited to the provision and construction of such supports, ramps, associated staircases and landings, escalators, lifts, ramps or lifts for disabled persons and such internal and external fittings and fixtures and such lighting fittings as the Director in his sole discretion may require. Each of the Covered Footbridges shall have a clear internal width of 6.0 metres or such other width as may be approved by the Commissioner for Transport and a minimum clear internal headroom of 2.6 metres;
 - (ii) modify the existing footbridge which is shown and marked as "**EXISTING FB**" on the plan annexed to the Land Grant together with all supports and connections (including any supports and connections which the Director in his absolute discretion considers necessary for any future extension to the existing footbridge) as shall be required or approved by the Director (collectively, "**the Existing Footbridge**") and provide and construct such supports, connections and extensions to the Existing Footbridge in the building or buildings to be erected on the lot (collectively, "**the Existing Footbridge Supports, Connections and Extensions**") so that pedestrian and cyclist access can be gained over the Existing Footbridge to and from the Pedestrian Link (as defined in Special Condition No. (36)(a) of the Land Grant). The modification and extension of the Existing Footbridge shall include provision of a cycle track of 2.8 metres in width or any other width as may be determined by the Commissioner for Transport. The Existing Footbridge Supports, Connections and Extensions shall be constructed with such materials and to such specifications, standards, levels, alignment, disposition and designs and at such points as shall be required and approved by the Director including but not limited to the provision and construction of such supports, ramps, associated staircases and landings, escalators, lifts, ramp(s) or lift(s) for disabled persons and such internal and external fittings and fixtures and such lighting fittings as the Director in his sole discretion may require.
- (c) Notwithstanding anything to the contrary contained in these Conditions, throughout the term agreed to be granted by the Land Grant the Grantee shall at his own expense repair, manage and maintain the Covered Footbridges and the Existing Footbridge Supports, Connections and Extensions and any replacement or replacements thereof which may be constructed by the Grantee in accordance with sub-clause (g) of Special Condition No. (35) of the Land Grant in a clean, tidy and good and substantial repair and condition and in all respects to the satisfaction of the Director.
- (e) (i) The Covered Footbridges and the Existing Footbridge Supports, Connections and Extensions shall not be used for any purpose other than for the passage of all members of the public on foot or by wheelchair or bicycle.

Summary of land grant

批地文件的摘要

- (ii) The Grantee shall not use or permit or suffer to be used any part of the Covered Footbridges and the Existing Footbridge Supports, Connections and Extensions either externally or internally for advertising or for the display of any signs, notices or posters whatsoever unless otherwise approved or required by the Director.
 - (iii) The Grantee shall not do or permit or suffer to be done in the Covered Footbridges and the Existing Footbridge Supports, Connections and Extensions anything that may be or become a nuisance or annoyance or that may cause inconvenience or damage to any person or vehicle passing under the Covered Footbridges and the Existing Footbridge Supports, Connections and Extensions or to any owner or occupier of any adjacent or neighbouring lot or lots or premises.
 - (iv) The Grantee shall throughout the period during which the Covered Footbridges are in existence permit all members of the public for all lawful purposes 24 hours a day freely and without payment of any nature whatsoever without any interruption to pass and repass on foot or by wheelchair or bicycle along, to, from, through, over, up and down the Covered Footbridges.
 - (v) The Grantee shall throughout the period during which the Existing Footbridge Supports, Connections and Extensions are in existence permit all members of the public for all lawful purposes 24 hours a day freely and without payment of any nature whatsoever without any interruption to pass and repass on foot or by wheelchair or bicycle along, to, from, through, over, up and down the Existing Footbridge Supports, Connections and Extensions.
 - (g) In the event of any redevelopment of the lot or any part thereof or otherwise whereby the Covered Footbridges or the Existing Footbridge Supports, Connections and Extensions or any part thereof are required to be demolished, the Grantee shall, within such time limit as shall be laid down by the Director, at his own expense and to the satisfaction of the Director, replace the same by the construction and completion of such new covered footbridges or new supports, connections and extensions to the Existing Footbridge or a part or parts thereof in such manner and with such design, materials and at such width, levels, standards, alignment and positions as the Director shall approve or require.
 - (h) There are reserved unto the Government, its officers, agents, contractors, workmen and other duly authorized personnel free of all costs and charges:
 - (i) all necessary rights of ingress, egress and regress to and from the lot for the purposes of erecting, installing, repairing and maintaining street lightings, traffic signs, traffic signals and other forms of equipment on the external part or parts of the Existing Footbridge and within the lot which in the opinion of the Director (whose opinion is final and binding on the Grantee) are considered necessary for regulating vehicular and pedestrian traffic;
 - (ii) all necessary rights of ingress, egress and regress to and from the lot for the purposes of inspecting, checking, supervising, managing, keeping, repairing and maintaining the Existing Footbridge and carrying out site investigation and survey as necessary for its reconstruction and renovation; and
 - (iii) the right to connect the Existing Footbridge to the Existing Footbridge Supports, Connections and Extensions.
 - (l) The Grantee shall at his own expense provide temporary public access to and from the Existing Footbridge 24 hours a day free of charge without any interruption to the satisfaction of the Commissioner for Transport whenever access to and from the Existing Footbridge is affected by the building works carried out by the Grantee.
 - (m) For the purpose of Special Condition No. (35) of the Land Grant, the expression "**Grantee**" shall exclude F.S.I.
26. **Pedestrian link to buildings and facilities**
- Special Condition No. (36)
- (a) The Grantee shall at his own expense and in all respects to the satisfaction of the Director lay, form, provide, construct and surface such segregated pedestrian ways or paths within the lot and any building or buildings erected or to be erected thereon (together with such stairs, ramps, lightings, ventilations, passenger lifts, escalators and footbridge supports as the Director in his absolute discretion may require) for the purposes as specified in sub-clause (b) of Special Condition No. (36) of the Land Grant at such positions, in such manner, with such materials and to such standards, levels, alignment and designs as may be required or approved by the Director. The said segregated pedestrian ways or paths together with such stairs, ramps, lightings, ventilations, passenger lifts, escalators and footbridge supports are hereinafter collectively referred to as "**the Pedestrian Link**".
 - (b) The Pedestrian Link shall follow the shortest possible routes and shall be covered and constructed and designed so as to:
 - (i) link up each and every building to be erected on the lot at such locations and levels of the building as may be required or approved by the Director; and
 - (ii) link up all major facilities within the lot including the Tai Wai Station, the Residential Accommodation, the Other Accommodation, the Existing Public Toilet, the Existing PTI, the New PTI, the Bicycle Park, the Cycle Track, the PSC, the Covered Footbridges, the Existing Footbridge, the PSC Lay-Bys referred to in Special Condition No. (49)(a) of the Land Grant, the Public Lay-By referred to in Special Condition No. (50)(a) of the Land Grant and the open space at such locations and levels as may be required or approved by the Director.
 - (c) The Grantee shall throughout the term agreed to be granted by the Land Grant manage and maintain at his own expense the Pedestrian Link in good and substantial condition and repair to the satisfaction of the Director.
 - (d) (i) The Grantee shall at his own expense and in all respects to the satisfaction of the Director design, provide and thereafter manage and maintain within the lot and any building or buildings erected or to be erected thereon a pedestrian walkway which shall comprise such escalators, passenger lifts, staircases, ramps and other structures as shall be required or approved by the Director (which pedestrian walkway is hereinafter referred to as "**the 24-hour Walkway**") so as to link up the Tai Wai Station, the Existing Public Toilet, the Existing PTI, the New PTI, the Bicycle Park, the Cycle Track, the PSC, the Covered Footbridges, the Existing Footbridge, the PSC Lay-Bys referred to in Special Condition No. (49)(a) of the Land Grant, the Public Lay-By referred to in Special Condition No. (50)(a) of the Land Grant, the ground level of the lot and the footpaths at street level adjacent to the lot. The Grantee shall submit a plan indicating the routing of the 24-hour Walkway to the Director for approval. The decision of the Director as to what constitutes the ground level of the lot and the street level shall be final and binding upon the Grantee.

Summary of land grant

批地文件的摘要

- (ii) The 24-hour Walkway (excluding the said escalators, passenger lifts, staircases, ramps and other structures) shall have a clear internal width of not less than 4.5 metres.
- (e) The Grantee shall throughout the term agreed to be granted by the Land Grant keep the 24-hour Walkway open for the use by the public 24 hours a day on foot or by wheelchair for all lawful purposes free of charge and without any interruption. The Grantee shall at his own expense keep the escalators and passenger lifts required to be provided under sub-clause (d)(i) of Special Condition No. (36) of the Land Grant in operation 24 hours a day to the satisfaction of the Director.
- (i) For the purpose of Special Condition No. (36) of the Land Grant, the expression "**Grantee**" shall exclude F.S.I.

27. Parking and loading and unloading requirements

Special Condition No. (43)

- (a) (i) Spaces shall be provided within the lot to the satisfaction of the Director for the parking of motor vehicles licensed under the Road Traffic Ordinance, any regulations made thereunder and any amending legislation, and belonging to the residents of the residential units in the building or buildings erected or to be erected on the lot and their bona fide guests, visitors or invitees ("**the Residential Parking Spaces**") at a rate to be calculated by reference to the respective size of the residential units erected or to be erected on the lot as set out in the table in Special Condition No. (43)(a)(i) of the Land Grant unless the Director consents to a rate for or to a number of the Residential Parking Spaces different from those set out in the table.
- (iii) (I) If more than 75 residential units are provided in any block of residential units erected or to be erected on the lot, additional spaces for the parking of motor vehicles licensed under the Road Traffic Ordinance, any regulations made thereunder and any amending legislation, and belonging to the bona fide guests, visitors or invitees of the residents of the residential units in the building or buildings erected or to be erected on the lot shall be provided at a rate of five spaces for every such block of residential units or at such other rates as may be approved by the Director subject to a minimum of two spaces being provided.
- (II) If 75 or less than 75 residential units are provided in any block of residential units erected or to be erected on the lot, additional spaces for the parking of motor vehicles licensed under the Road Traffic Ordinance, any regulations made thereunder and any amending legislation, and belonging to the bona fide guests, visitors or invitees of the residents of the residential units in the building or buildings erected or to be erected on the lot shall be provided at a rate of one space for every such block of residential units or at such other rates as may be approved by the Director subject to a minimum of two spaces being provided.
- (iv) The spaces provided under sub-clauses (a)(i) and (a)(iii) of Special Condition No. (43) of the Land Grant (as may be varied under Special Condition No. (45) of the Land Grant) shall not be used for any purpose other than those respectively stipulated therein and in particular the said spaces shall not be used for the storage, display or exhibiting of motor vehicles for sale or otherwise or for the provision of car cleaning and beauty services.

- (b) (i) Spaces shall be provided within the lot to the satisfaction of the Director for the parking of motor vehicles at a rate of one space for every 200 square metres or part thereof of the gross floor area of the building or buildings erected or to be erected on the lot to be used for the Other Accommodation unless the Director consents to another rate.
- (ii) Apart from the spaces required to be provided under sub-clause (b)(i) of Special Condition No. (43) of the Land Grant, the Grantee shall provide within the lot to the satisfaction of the Director an addition of 80 spaces for the Other Accommodation.
- (iv) The spaces provided under sub-clauses (b)(i) and (b)(ii) of Special Condition No. (43) of the Land Grant (as may be varied under Special Condition No. (45) of the Land Grant) shall not be used for any purpose other than for the parking of motor vehicles licensed under the Road Traffic Ordinance, any regulations made thereunder and any amending legislation, and belonging to the occupiers of the building or buildings erected or to be erected on the lot for such purposes stipulated in the said sub-clauses and their bona fide guests, visitors or invitees and in particular the said spaces shall not be used for the storage, display or exhibiting of motor vehicles for sale or otherwise or for the provision of car cleaning and beauty services.
- (c) Eight spaces shall be provided within the lot to the satisfaction of the Director for the parking of motor vehicles licensed under the Road Traffic Ordinance, any regulations made thereunder and any amending legislation, and belonging to the occupiers of the PSC and their bona fide guests, visitors or invitees and in particular the said spaces shall not be used for the storage, display or exhibiting of motor vehicles for sale or otherwise or for the provision of car cleaning and beauty services.
- (d) (i) Out of the spaces provided under sub-clauses (a)(i), (a)(iii), (b)(i) and (b)(ii) of Special Condition No. (43) of the Land Grant (all as may be varied under Special Condition No. (45) of the Land Grant) and sub-clause (c) of Special Condition No. (43) of the Land Grant, the Grantee shall reserve and designate such number of spaces for the parking of motor vehicles by disabled persons as defined in the Road Traffic Ordinance, any regulations made thereunder and any amending legislation ("**the Parking Spaces for the Disabled Persons**") as the Building Authority may require and approve provided that a minimum of one space shall be so reserved and designated out of the spaces provided under sub-clause (a)(iii) of Special Condition No. (43) of the Land Grant (as may be varied under Special Condition No. (45) of the Land Grant) and that the Grantee shall not designate or reserve all of the spaces provided under sub-clause (a)(iii) of Special Condition No. (43) of the Land Grant (as may be varied under Special Condition No. (45) of the Land Grant) to become the Parking Spaces for the Disabled Persons.
- (ii) The Parking Spaces for the Disabled Persons shall not be used for any purpose other than for the parking of motor vehicles by disabled persons as defined in the Road Traffic Ordinance, any regulations made thereunder and any amending legislation, and belonging to the residents or occupiers of the building or buildings erected or to be erected on the lot and their bona fide guests, visitors or invitees and in particular the said spaces shall not be used for the storage, display or exhibiting of motor vehicles for sale or otherwise or for the provision of car cleaning and beauty services.

Summary of land grant

批地文件的摘要

- (e) (i) Spaces shall be provided within the lot to the satisfaction of the Director for the parking of motor cycles licensed under the Road Traffic Ordinance, any regulations made thereunder and any amending legislation, at the following rates unless the Director consents to another rate:
- (I) ten percent of the total number of the Residential Parking Spaces required to be provided under sub-clause (a)(i) of Special Condition No. (43) of the Land Grant (as may be varied under Special Condition No. (45) of the Land Grant) and the spaces required to be provided under sub-clause (a)(iii) of Special Condition No. (43) of the Land Grant (as may be varied under Special Condition No. (45) of the Land Grant) ("**the Residential Motor Cycle Parking Spaces**");
 - (II) ten percent of the total number of spaces required to be provided under sub-clauses (b)(i) and (b)(ii) of Special Condition No. (43) of the Land Grant (as may be varied under Special Condition No. (45) of the Land Grant);
 - (III) five spaces for the PSC; provided that if the number of spaces to be provided is a decimal number, the same shall be rounded up to the next whole number.
- (ii) The Residential Motor Cycle Parking Spaces shall not be used for any purpose other than for the parking of motor cycles licensed under the Road Traffic Ordinance, any regulations made thereunder and any amending legislation, and belonging to the residents of the residential units in the building or buildings erected or to be erected on the lot and their bona fide guests, visitors or invitees and in particular the said spaces shall not be used for the storage, display or exhibiting of motor vehicles for sale or otherwise or for the provision of car cleaning and beauty services.
- (iii) The spaces provided under sub-clause (e)(i)(III) of Special Condition No. (43) of the Land Grant shall not be used for any purpose other than for the parking of motor cycles licensed under the Road Traffic Ordinance, any regulations made thereunder and any amending legislation, and belonging to the occupiers of the building or buildings erected or to be erected on the lot for the purposes stipulated in sub-clauses (b)(i) and (b)(ii) of Special Condition No. (43) of the Land Grant and their bona fide guests, visitors or invitees and in particular the said spaces shall not be used for the storage, display or exhibiting of motor vehicles for sale or otherwise or for the provision of car cleaning and beauty services.
- (iv) The spaces provided under sub-clause (e)(i)(III) of Special Condition No. (43) of the Land Grant shall not be used for any purpose other than for the parking of motor cycles licensed under the Road Traffic Ordinance, any regulations made thereunder and any amending legislation, and belonging to the occupiers of the PSC and their bona fide guests, visitors or invitees and in particular the said spaces shall not be used for the storage, display or exhibiting of motor vehicles for sale or otherwise or for the provision of car cleaning and beauty services.
- (f) Spaces shall be provided within the lot to the satisfaction of the Director for the parking of bicycles belonging to the residents of the residential units in the building or buildings erected or to be erected on the lot and their bona fide guests, visitors or invitees at a rate of one space for every 20 units or part thereof for those residential units, size of each residential unit is less than 70 square metres or at such other rates as may be approved by the Director.

Special Condition No. (44)

- (a) Spaces shall be provided within the lot to the satisfaction of the Director for the loading and unloading of goods vehicles at the following rates or number unless the Director consents to other rates or number:
- (i) (I) if more than 75 residential units are provided in any block of residential units erected or to be erected on the lot, a minimum of one loading and unloading space for every such block of residential units erected or to be erected on the lot, such loading and unloading space to be located adjacent to or within every such block of residential unit;
 - (II) if 75 or less than 75 residential units are provided in any block of residential units erected or to be erected on the lot, a minimum of two loading and unloading spaces for all such blocks of residential units erected or to be erected on the lot, such loading and unloading spaces to be located adjacent to or within such blocks of residential units;
 - (ii) one space for every 1,200 square metres or part thereof of the gross floor area of the building or buildings erected or to be erected on the lot to be used for the Other Accommodation.
- (b) Such spaces shall not be used for any purpose other than for the loading and unloading of goods vehicles in connection with the building or buildings referred to therein.

Special Condition No. (47)

- (a) Notwithstanding that these Conditions shall have been observed and complied with to the satisfaction of the Director, the Residential Parking Spaces and the Residential Motor Cycle Parking Spaces shall not be:
- (i) assigned except
 - (I) together with Undivided Shares (as defined in Special Condition No. (4)(a) of the Land Grant) giving the right of exclusive use and possession of a residential unit or units in the building or buildings erected or to be erected on the lot; or
 - (II) to a person who is already the owner of Undivided Shares with the right of exclusive use and possession of a residential unit or units in the building or buildings erected or to be erected on the lot; or
 - (ii) underlet except to the residents of the residential units in the building or buildings erected or to be erected on the lot.

Provided that in any event not more than three in number of the total of the Residential Parking Spaces and the Residential Motor Cycle Parking Spaces shall be assigned to the owner or underlet to the resident of any one residential unit in the building or buildings erected or to be erected on the lot.

Summary of land grant

批地文件的摘要

- (d) Sub-clause (a) of Special Condition No. (47) of the Land Grant shall not apply to the Parking Spaces for the Disabled Persons.

Special Condition No. (48)

The spaces provided within the lot in accordance with Special Condition Nos. (43)(a)(iii) of the Land Grant (as may be varied under Special Condition No. (45) of the Land Grant), the Parking Spaces for the Disabled Persons and the spaces provided within the lot in accordance with Special Conditions Nos. (43)(f) and (44)(a) of the Land Grant shall be designated as and form part of the Common Areas.

28. Provision of PSC Lay-Bys

Special Condition No. (49)

- (a) The Grantee shall on or before 30th day of September, 2022 or within such time limit as may be specified and subject to such conditions as may be approved by the Director at his own expense and in all respects to the satisfaction of the Director provide and thereafter manage and maintain at the ground level of the lot (the decision of the Director as to what constitutes the ground level shall be final and binding on the Grantee) one lay-by measuring 3.5 metres in width and 11.0 metres in length with a minimum headroom of 4.7 metres and not less than one lay-by measuring 2.5 metres in width and 40 metres in aggregate length with a minimum headroom of 2.4 metres for the picking up and setting down of passengers from motor vehicles (including taxis) (collectively, "**the PSC Lay-Bys**") in connection with the PSC.
- (e) The PSC Lay-Bys provided within the lot in accordance with sub-clause (a) of Special Condition No. (49) of the Land Grant shall be designated as and form part of the Common Areas.
- (f) The Grantee shall throughout the term agreed to be granted by the Land Grant keep the PSC Lay-Bys open for use by the occupiers of the PSC and their bona fide guests, visitors or invitees 24 hours a day free of charge without any interruption to the satisfaction of the Director.

29. Provision of Public Lay-By

Special Condition No. (50)

- (a) The Grantee shall on or before 30th day of September, 2022 or within such time limit as may be specified and subject to such conditions as may be approved by the Director at his own expense and in all respects to the satisfaction of the Director provide and thereafter manage and maintain at the ground level of the lot near the junction between Chui Tin Street and Che Kung Miu Road or at such other location as may be determined by the Director (the decision of the Director as to what constitutes the ground level shall be final and binding on the Grantee) not less than one public lay-by measuring 3.5 metres in width and 40.0 metres in aggregate length for the picking up and setting down of passengers from motor vehicles (including taxis) ("**the Public Lay-By**"). The Grantee shall submit or cause to be submitted to the Commissioner for Transport detailed design proposal of the Public Lay-By for his written approval prior to commencement of building works.

- (e) The Public Lay-By provided within the lot in accordance with sub-clause (a) of Special Condition No. (50) of the Land Grant shall be designated as and form part of the Common Areas.

- (f) The Grantee shall throughout the term agreed to be granted by the Land Grant keep the Public Lay-By open for use by the public 24 hours a day free of charge without any interruption to the satisfaction of the Director.

30. Refuse collection

Special Condition No. (52)

- (a) The Grantee shall at his own expense provide, construct and maintain in all respects to the satisfaction of the Director of Food and Environmental Hygiene a comprehensive system of refuse collection from each floor of the building or buildings erected or to be erected on the lot.
- (b) (i) The Grantee shall at his own expense and in all respects to the satisfaction of the Director provide, construct and thereafter maintain with such materials and to such standards and design and in such location within the lot one refuse collection point together with such ancillary facilities as the Director of Food and Environmental Hygiene shall approve ("**the Refuse Collection Point**") and such spaces (which shall not be less than one) for the parking, loading and unloading of refuse collection vehicles as may be approved or required by the Director of Food and Environmental Hygiene in accordance with the Approved Building Plans on such date or dates as shall be determined by the Director.
- (iii) (I) The spaces for the parking, loading and unloading of refuse collection vehicles provided in accordance with sub-clause (b)(i) of Special Condition No. (52) of the Land Grant shall not be used for any purpose other than for the purpose of parking, loading and unloading of refuse collection vehicles.

31. Cutting away

Special Condition No. (54)

- (a) Where there is or has been any cutting away, removal or setting back of any land, or any building-up or filling-in or any slope treatment works of any kind whatsoever, whether with or without the prior written consent of the Director, either within the lot or on any Government land, which is or was done for the purpose of or in connection with the formation, levelling or development of the lot or any part thereof or any other works required to be done by the Grantee under these Conditions, or for any other purpose, the Grantee shall at his own expense carry out and construct such slope treatment works, retaining walls or other support, protection, drainage or ancillary or other works as shall or may then or at any time thereafter be necessary to protect and support such land within the lot and also any adjacent or adjoining Government or leased land and to obviate and prevent any falling away, landslip or subsidence occurring thereafter. The Grantee shall at all times during the term agreed to be granted by the Land Grant maintain at his own expense the said land, slope treatment works, retaining walls or other support, protection, drainage or ancillary or other works in good and substantial repair and condition to the satisfaction of the Director.

Summary of land grant

批地文件的摘要

(c) In the event that as a result of or arising out of any formation, levelling, development or other works done by the Grantee or owing to any other reason, any falling away, landslip or subsidence occurs at any time, whether in or from any land, within the lot or from any adjacent or adjoining Government or leased land, the Grantee shall at his own expense reinstate and make good the same to the satisfaction of the Director and shall indemnify the Government, its agents and contractors from and against all costs, charges, damages, demands and claims whatsoever which shall or may be made, suffered or incurred through or by reason of such falling away, landslip or subsidence.

(d) In addition to any other rights or remedies herein provided for breach of any of these Conditions, the Director shall be entitled by notice in writing to call upon the Grantee to carry out, construct and maintain the said land, slope treatment works, retaining walls, or other support, protection, and drainage or ancillary or other works or to reinstate and make good any falling away, landslip or subsidence, and if the Grantee shall neglect or fail to comply with the notice to the satisfaction of the Director within the period specified therein, the Director may forthwith execute and carry out any necessary works and the Grantee shall on demand repay to the Government the cost thereof, together with any administrative and professional fees and charges.

32. Anchor maintenance

Special Condition No. (56)

Where prestressed ground anchors have been installed, upon development or redevelopment of the lot or any part thereof, the Grantee shall at his own expense carry out regular maintenance and regular monitoring of the prestressed ground anchors throughout their service life to the satisfaction of the Director and shall supply to the Director such reports and information on all such monitoring works as the Director may from time to time in his absolute discretion require. If the Grantee shall neglect or fail to carry out the required monitoring works, the Director may forthwith execute and carry out the monitoring works and the Grantee shall on demand repay to the Government the cost thereof.

33. Spoil or debris

Special Condition No. (57)

(a) In the event of earth, spoil, debris, construction waste or building materials ("**the waste**") from the lot, or from other areas affected by any development of the lot being eroded, washed down or dumped onto public lanes or roads or into or onto road-culverts, foreshore or seabed, sewers, storm-water drains or nullahs or other Government properties ("**the Government properties**"), the Grantee shall at his own expense remove the waste from and make good any damage done to the Government properties. The Grantee shall indemnify the Government against all actions, claims and demands arising out of any damage or nuisance to private property caused by such erosion, washing down or dumping.

34. Damage to Services

Special Condition No. (58)

The Grantee shall take or cause to be taken all proper and adequate care, skill and precautions at all times, and particularly when carrying out construction, maintenance, renewal or repair work ("**the Works**"), to avoid causing any damage, disturbance or obstruction to any Government or other existing drain, waterway or watercourse, water main, road, footpath, street furniture, sewer, nullah, pipe, cable, wire, utility service or any other works or installations being or running upon, over, under or adjacent to the lot or any part thereof or the Green Areas (collectively "**the Services**"). The Grantee shall prior to carrying out any of the Works make or cause to be made such proper search and enquiry as may be necessary to ascertain the present position and levels of the Services, and shall submit his proposals for dealing with any of the Services which may be affected by the Works in writing to the Director for his approval in all respects, and shall not carry out any work whatsoever until the Director shall have given his written approval to the Works and to such aforesaid proposals. The Grantee shall comply with and at his expense meet any requirements which may be imposed by the Director in respect of the Services in granting the aforesaid approval, including the cost of any necessary diversion, relaying or reinstatement. The Grantee shall at his own expense in all respects repair, make good and reinstate to the satisfaction of the Director any damage, disturbance or obstruction caused to the lot or any part thereof or the Green Areas or both the lot or any part thereof and the Green Areas or any of the Services in any manner arising out of the Works (except for nullah, sewer, storm-water drain or water main, the making good of which shall be carried out by the Director, unless the Director elects otherwise, and the Grantee shall pay to the Government on demand the cost of such works). If the Grantee fails to carry out any such necessary diversion, relaying, repairing, making good and reinstatement of the lot or any part thereof or the Green Areas or both the lot or any part thereof and the Green Areas or of any of the Services to the satisfaction of the Director, the Director may carry out any such diversion, relaying, repairing, making good or reinstatement as he considers necessary and the Grantee shall pay to the Government on demand the cost of such works.

35. Construction of drains and channels and connecting drains and sewers

Special Condition No. (59)

(a) The Grantee shall construct and maintain at his own expense and to the satisfaction of the Director such drains and channels, whether within the boundaries of the lot or on Government land, as the Director may consider necessary to intercept and convey into the nearest stream-course, catchpit, channel or Government storm-water drain all storm-water or rain-water falling or flowing on to the lot, and the Grantee shall be solely liable for and shall indemnify the Government and its officers from and against all actions, claims and demands arising out of any damage or nuisance caused by such storm-water or rain-water.

(b) The works of connecting any drains and sewers from the lot to the Government storm-water drains and sewers, when laid and commissioned, may be carried out by the Director who shall not be liable to the Grantee for any loss or damage thereby occasioned and the Grantee shall pay to the Government on demand the cost of such connection works. Alternatively, the said connection works may be carried out by the Grantee at his own expense to the satisfaction of the Director and in such case any section of the said connection works which is constructed within Government land shall be maintained by the Grantee at his own cost and upon demand be handed over by the Grantee to the Government for future maintenance thereof at the expense of the Government and the Grantee shall pay to the Government on demand the cost of the technical audit in respect of the said connection works.

Summary of land grant 批地文件的摘要

36. Drainage Reserve

Special Condition No. (60)

- (a) No building or structure or foundation or support for any building or structure shall be erected or constructed or placed on, over, under, above, below or within the areas of the lot shown coloured pink cross-hatched black, pink cross-hatched black stippled black, pink cross-hatched black stippled red and pink cross-hatched black stippled red hatched black on the plan annexed to the Land Grant (the said coloured areas are hereinafter collectively referred to as "**the Drainage Reserve**") and no trees or shrubs with penetrating roots shall be planted on the Drainage Reserve except:
- (i) the existing structures or supports including the existing drainage pipe and the relocated drainage pipe as referred to in sub-clause (f)(i) of Special Condition No. (60) of the Land Grant, the Existing Water Mains as referred to in sub-clause (i) of Special Condition No. (61) of the Land Grant, the Existing Public Toilet and the Existing PTI which are erected or constructed or placed on, over, under, above, below or within the Drainage Reserve at the date of the Land Grant;
 - (ii) the New PTI;
 - (iii) the vehicular access road at grade;
 - (iv) the public passageway at grade;
 - (v) the PSC Lay-Bys and the Public Lay-By; and
 - (vi) any other structure or structures as may be approved by the Director.
- (b) Notwithstanding sub-clause (a) of Special Condition No. (60) of the Land Grant but subject to the prior written approval of the Director, building or buildings may be erected or constructed over or above the Drainage Reserve provided that there are a clear air space extending upwards from the ground level of the area of the lot shown coloured pink cross-hatched black and pink cross-hatched black stippled black on the plan annexed to the Land Grant to a height of not less than 5.1 metres and a clear air space extending upwards from the ground level of the area of the lot shown coloured pink cross-hatched black stippled red and pink cross-hatched black stippled red hatched black on the plan annexed to the Land Grant to a height of not less than 8.0 metres. For the purpose of Special Condition No. (60) of the Land Grant, the decision of the Director as to what constitutes the ground level shall be final and binding upon the Grantee.
- (c) Neither the Grantee nor any other person shall have any right or claim to compensation against the Government whatsoever under any enactment or otherwise in respect of the rights and obligations referred to in sub-clauses (a) and (b) of Special Condition No. (60) of the Land Grant or in respect of or as a consequence of the use of the Drainage Reserve.

- (d) Throughout the term agreed to be granted by the Land Grant, the Director and his duly authorized officers, contractors, his or their workmen (hereinafter collectively referred to as "**the authorized persons**") with or without tools, equipment, machinery or motor vehicles shall have the right of unrestricted ingress, egress and regress at all times to, from and through the lot for the purposes of laying, inspecting, repairing and maintaining any drains, sewers, channels, drainage facilities and all other services running across, through or under the Drainage Reserve ("**the Utilities**") which the Director may require or authorize. No object or material of whatsoever nature which may obstruct access or cause excessive surcharge to the Utilities shall be placed within the Drainage Reserve. Where in the opinion of the Director (whose opinion shall be final and binding on the Grantee), there are objects or material within the Drainage Reserve which may obstruct access or cause excessive surcharge to the Utilities, the Director shall be entitled by notice in writing to call upon the Grantee, at his own expense and in all respects to the satisfaction of the Director, to demolish or remove such objects or material and to reinstate the Drainage Reserve.
- (e) Save in respect of the reinstatement of any trench excavated in the exercise of the aforesaid rights and powers, the Government and the authorized persons shall have no liability in respect of any loss, damage, nuisance or disturbance whatsoever caused to or suffered by the Grantee arising out of or incidental to the exercise by the authorized persons of the right of unrestricted ingress, egress and regress and in laying, inspecting, repairing and maintaining the Utilities conferred under sub-clause (d) of Special Condition No. (60) of the Land Grant and no claim whatsoever shall be made against the Government or the authorized persons by the Grantee in respect of any such loss, damage, nuisance or disturbance.
- (f) (i) The Grantee shall, upon demand by the Director of Drainage Services, at his own expense and in all respects to the satisfaction of the Director of Drainage Services divert the existing drainage pipe now lying within the Drainage Reserve as shown by the red line on the plan annexed to the Land Grant to a new location as shown by the green line on the plan annexed to the Land Grant ("**the diversion work**"). Upon completion of the diversion work, the Drainage Reserve shall be reduced to a smaller area as shown coloured pink cross-hatched black stippled black, pink cross-hatched black stippled red and pink cross-hatched black stippled red hatched black on the plan annexed to the Land Grant ("**the New Drainage Reserve**") and the provisions contained in sub-clauses (a) to (e) of Special Condition No. (60) of the Land Grant shall apply to the New Drainage Reserve.
- (ii) Prior to the commencement of the diversion work, the Grantee shall obtain the prior written approval of the Director of Drainage Services and shall take all necessary precautionary measures to ensure that the diversion work will not affect the operation of the existing drainage system within the Drainage Reserve.

37. Waterworks Reserve

Special Condition No. (61)

- (a) Except with the prior written consent of the Director of Water Supplies, no building or structure or support for any building or structure shall be erected or constructed or placed on, over, under, above, below or within the areas of the lot enclosed by the dashed blue lines shown and marked "**WWR**" on the plan annexed to the Land Grant ("**the Waterworks Reserve**") other than the structures which at the date of the Land Grant are or shall be permitted to be erected or constructed or placed on, over, under, above, below or within the Waterworks Reserve. No materials or object shall be placed or stacked nor vehicles (except those that can be readily driven away) parked on or within the Waterworks Reserve. The decision of the Director of Water Supplies as to whether the vehicles can be readily driven away shall be final and binding on the Grantee.

Summary of land grant

批地文件的摘要

- (b) Notwithstanding sub-clause (a) of Special Condition No. (61) of the Land Grant, and subject to Special Condition No. (60)(a) and (60)(b) of the Land Grant, building or buildings may be erected or constructed over or above the Waterworks Reserve provided that there is a clear air space extending upwards from the ground level to a height of not less than 5.1 metres. The decision of the Director as to what constitutes the ground level shall be final and binding upon the Grantee.
- (c) No planting or obstruction of any kind except turfing shall be permitted within the space of 1.5 metres around the cover of any valve or within a distance of 1.0 metre from any hydrant outlet within the Waterworks Reserve.
- (d) Except with the prior written approval of the Director of Water Supplies, tree or shrub planting and site formation shall be prohibited within the Waterworks Reserve.
- (e) If diversion of the Government water mains laid within the Waterworks Reserve is required by the Grantee, the proposed routing has to be approved by the Director of Water Supplies and the cost of relocating the Government water mains shall be borne by the Grantee and such part or parts of the lot on, over, under, above, below or within which the new water mains is or are laid shall also form part of the Waterworks Reserve.
- (f) The Grantee shall pay to the Government on demand the cost of repair and reinstatement to any Government water mains, valves, valve pits, chambers or other waterworks structures and facilities and the like relating to the Government water mains which shall become necessary at any time during the term agreed to be granted by the Land Grant as a result of damage caused by the Grantee or other activities carried out on, over, under, above, below or within the lot by the Grantee, his servants, workmen and contractors and shall indemnify the Government against any such claim, action or demand arising therefrom.
- (g) There is reserved unto the Government and the Director of Water Supplies, its or their officers, officers of other Government departments designated by the Director of Water Supplies, contractors, licensees, workmen whether employed by the Director of Water Supplies or by other designated Government departments or by their duly authorized contractors or licensees, whether with or without tools, equipment, plant, machinery or motor vehicles the right of free and unrestricted ingress, egress and regress and at all times to, from and through the lot or any part thereof for the purposes of inspecting, laying, installing, operating, maintaining, repairing and renewing any or all of the existing Government water mains valves, valve pits, chambers or other waterworks structures and facilities and the like relating to the Government water mains running across, through or under the Waterworks Reserve.
- (i) The Grantee acknowledges that there are Government water mains, valves, valve pits, chambers and other waterworks structures and facilities (collectively, "**the Existing Water Mains**") within the Waterworks Reserve. The Government will accept no responsibility or liability for any damage, nuisance or disturbance caused to or suffered by the Grantee by reason of the presence of the Existing Water Mains and the Grantee hereby indemnifies and shall keep indemnified the Government from and against all liabilities, claims, costs, demands, actions or other proceedings whatsoever arising whether directly or indirectly out of or in connection with the presence of the Existing Water Mains.
- (j) No removal or relocation of the Existing Water Mains shall be carried out without the prior written approval of the Director of Water Supplies who may, in granting approval, impose such conditions as he may deem appropriate.

38. Setting-back Area

Special Condition No. (62)

- (a) Subject to Special Condition No. (60) of the Land Grant, except with the prior written consent of the Director, no building or structure or support for any building or structure shall be erected or constructed or placed, and no object or material of whatsoever nature shall be stored or placed on, over or above the ground level of those parts of the lot shown coloured pink hatched black and pink cross-hatched black stippled red hatched black on the plan annexed to the Land Grant (collectively, "**the Setting-back Area**").
- (b) Notwithstanding the provision in sub-clause (a) of Special Condition No. (62) of the Land Grant, the Grantee may erect or allow to be erected on the Setting-back Area such landscaping and recreational facilities, canopies, covered walkway, other structures as shown on the Approved Landscape Master Plan or any master layout plan or plans approved by the Town Planning Board and such other structures or facilities as may be approved in writing by the Director.
- (c) The disposition, location, configuration, length and width of the Setting-back Area may vary to accord with the master layout plan or plans approved or to be approved by the Town Planning Board subject to the approval of the Director in writing on such terms and conditions to be determined by the Director at his sole discretion.
- (d) The Grantee shall throughout the term agreed to be granted by the Land Grant keep the Setting-back Area open for use by the public for all lawful purposes 24 hours a day free of charge without any interruption to the satisfaction of the Director.
- (h) Throughout the term agreed to be granted by the Land Grant the Grantee shall at his own expense manage and maintain the Setting-back Area and all the structures and facilities erected or to be erected thereon in accordance with sub-clause (b) of Special Condition No. (62) of the Land Grant in good and substantial repair and condition in all respects to the satisfaction of the Director.
- (j) For the purpose of Special Condition No. (62) of the Land Grant, the expression "**Grantee**" shall exclude F.S.I.

39. Permission to construct noise abatement canopy over Government land

Special Condition No. (64)

- (a) The Grantee with the prior written consent of the Director, who may at his sole discretion, give his consent subject to such terms and conditions as he sees fit including the payment of any premium by the Grantee as the Director may determine, shall be permitted at the Grantee's own expense and in all respects to the satisfaction of the Director to construct a noise abatement canopy or canopies extending from the boundary of the lot over the Government land along Che Kung Miu Road ("**the Projected Canopy**").
- (b) The Grantee shall at his own expense upkeep, manage, maintain, repair and clean the Projected Canopy or any part or parts thereof or any replacement thereof to be provided by the Grantee in accordance with sub-clause (d) of Special Condition No. (64) of the Land Grant in good and substantial repair and condition in all respects to the satisfaction of the Director. The Grantee shall at all Government land along Che Kung Miu Road or such other areas on the adjoining Government land which the Director may approve from time to time with or without tools, equipment, plant, machinery or motor vehicles for the purposes of carrying out any inspection, construction, alteration, repair, management, maintenance, cleaning, removal and replacement of the Projected Canopy.

Summary of land grant

批地文件的摘要

- (d) In the event of any redevelopment of the lot or any part thereof whereby the Projected Canopy or any part or parts thereof are required to be demolished, the Grantee with the prior written consent of the Director, who may at his sole discretion, give his consent subject to such terms and conditions as the Director sees fit, shall be permitted at the Grantee's own expense and in all respects to the satisfaction of the Director, to replace the same by the construction and completion of such new noise abatement canopy or a part or parts thereof.
- (f) No alteration or addition to the Projected Canopy or any part or parts thereof shall be made without obtaining the prior written consent of the Director.
- (g) The Grantee shall at all times take such precautions as may be necessary to prevent any damage or injury being caused to the Government land or to any persons or vehicles using the Government land as a result of the construction, alteration, repair, management, maintenance, cleaning, removal, replacement or use of the Projected Canopy.
- (h) For the purpose of Special Condition No. (64) of the Land Grant, the expression "Grantee" shall exclude F.S.I.

40. Railway protection

Special Condition No. (65)

- (a) Without prejudice to the Government's right stipulated in Special Condition No. (33) of the Land Grant, in the event any person exercises any of the rights conferred upon him by these Conditions on the Tai Wai Station, the Grantee shall undertake all necessary facilitation works to facilitate or enable such person to exercise such rights and such person shall
 - (i) not, without the consent of the Grantee (which consent shall not be unreasonably withheld), do anything which might adversely affect the operation or safety of the KCRC Railway and in the event of any injurious affection make reasonable compensation therefor;
 - (ii) do as little damage as possible and make reasonable compensation for all damage done; and
 - (iii) reimburse the Grantee for any expenses incurred by the Grantee in undertaking works to facilitate or enable such person to exercise such rights.
- (b) The Grantee shall undertake all necessary facilitation works in conjunction with the works of the person referred to in sub-clause (a) of Special Condition No. (65) of the Land Grant and such person shall
 - (i) not, without the consent of the Grantee (which consent shall not be unreasonably withheld), require the Grantee to do anything which might adversely affect the operation or safety of the KCRC Railway and in the event of any injurious affection as a consequence of such person's requirement, such person shall make reasonable compensation therefor;
 - (ii) ensure that any facilitation works required by such person will do as little damage as possible and make reasonable compensation for all damage done; and
 - (iii) reimburse the Grantee for any expenses incurred by the Grantee in undertaking works to facilitate or enable such person to exercise his rights.

- (c) For the purpose of Special Condition No. (65) of the Land Grant, the expression "Grantee" shall mean only the person entering into and executing the Land Grant and KCRC (as defined in Special Condition No. (29)(b) of the Land Grant).

41. No hawkers

Special Condition No. (66)

The Grantee shall not permit or suffer any hawker to carry on business within the lot, the Tai Wai Station, the Existing Footbridge Supports, Connections and Extensions and the Covered Footbridges and shall remove therefrom any hawker found to be so doing. Notices to the effect that hawking is prohibited within the lot, the Tai Wai Station, the Existing Footbridge Supports, Connections and Extensions and the Covered Footbridges shall be displayed prominently by the Grantee near all entrances to the lot. For the purposes of these Conditions, "hawker" shall be as defined in section 2 of the Public Health and Municipal Services Ordinance, any regulations made thereunder and any amending legislation provided that for the purpose of Special Condition No. (66) of the Land Grant the words "in any public place" shall be omitted from paragraph (a) of such definition and shall be substituted by the words "within the lot, the Tai Wai Station, the Existing Footbridge Supports, Connections and Extensions and the Covered Footbridges other than any part thereof permitted to be used for commercial purposes in accordance with these Conditions."

42. No advertisement

Special Condition No. (67)

The Grantee shall not, without the prior written consent of the Director, erect or permit or suffer to be erected on any part or parts of the Tai Wai Station or any external part or parts thereof any advertising sign, hoarding notice board or poster for outdoor advertising purposes and then even with such consent only in accordance with such terms and conditions as the Director may in his absolute discretion require or prescribe save that the prior written consent of the Director shall not be required in case of signs, notices or posters which are erected on any part or parts of the Tai Wai Station and which pertain directly to the operation of the railway.

43. No grave or columbarium permitted

Special Condition No. (68)

No grave or columbarium shall be erected or made on the lot, nor shall any human remains or animal remains whether in earthenware jars, cinerary urns or otherwise be interred therein or deposited thereon.

Remark :

For full details, please refer to the Land Grant. Full script of the Land Grant is available for free inspection upon request at the sales office during opening hours and copies of the Land Grant can be obtained upon paying necessary photocopying charges.

Summary of land grant

批地文件的摘要

1. 該期數位於沙田市地段第520號(「**該地段**」)。

2. 該地段根據2015年1月26日所訂立的《新批地契約》第22001號(經一份日期為2017年1月26日並於土地註冊處以註冊摘要編號17022301530249登記的修訂書變更或修改)(「**批地文件**」)規定，批租年期為50年，由2015年1月26日起至2065年1月25日止。

3. 用途

特別條款第(12)條

(a) 除此等條款(按批地文件一般條款第12(b)條定義)和批地文件特別條款第28(a)條的規定外，該地段或其中任何部分或在其上已建或擬建的任何建築物或建築物之部分除用作非工業用途(不包括倉庫、酒店及加油站)以外，不得用作任何其他用途。

(b) 在不影響批地文件特別條款第12條(a)款的一般規定，該地段或其中任何部分或在其上已建或擬建的任何建築物或建築物之部分除按照此等條款、經批准建築圖則(按批地文件特別條款第(10)(b)(i)條定義)、批地文件特別條款第(14)條提及的經批准園景設計總圖(按批地文件特別條款第(14)(c)條定義)及城市規劃委員會批准的任何總發展藍圖或圖則所設計、建築及擬定之用途以外，概不可作任何其他用途。

特別條款第(28)條

(a) 承批人(按批地文件一般條款第12(a)條定義)確認於批地文件之日在該地段上已興建了一個鐵路站。該鐵路站連同營運鐵路的該等輔助鐵路構築物、設施、隧道及道路(該鐵路站及其輔助鐵路構築物、設施、隧道及道路在下文統稱為「**大圍站**」)，只能用作鐵路站之用途和配合使用、營運及管理九廣鐵路(「**九廣鐵路**」)(為免存疑，不包括職員用房)之用途及地政總署署長(「**署長**」)書面批准的其他用途，署長可在作出批准時施加他認為合適的條款及條件，包括支付地價。

(b) 即使批地文件特別條款第(28)(a)條的規定，承批人可使用或准許或容許他人使用大圍站或其中任何部分提供服務或貨物給鐵路乘客使用或享用。

(c) 承批人須按此等條款及經批准建築圖則(如適用)自費使用、運作及保養大圍站以供九廣鐵路營運，在一切方面使署長滿意。

4. 承批人彌償

一般條款第4條

倘若承批人違反此等條款又或毗連或毗鄰土地或該地段受損或出現泥土及地下水污染，而署長認為(其意見將為終論並對承批人具有約束力)有關損害或泥土及地下水污染乃因承批人使用該地段或該地段的任何發展項目或重建項目或其任何部份又或承批人在該地段進行任何活動或執行任何工程所致，則不論承批人使用該地段、發展或重建、進行活動或執行工程是否遵從或違反此等條款，承批人現承諾就任何由此招致或產生的訴訟、法律程序、責任、要求、費用、開支、損失(不論屬經濟或其他性質)及索償向政府作出彌償並確保其被持續彌償。

5. 保養

一般條款第6條

(a) 承批人應在整個批租期內遵照此等條款進行建造或重建工程(該詞指以下(b)款所述的重建工程)：

- (i) 依照經核准的設計、規劃或高度及任何核准建築圖則(不得作任何更改或修改)維修所有建築物；
- (ii) 保養於批地文件之日已經或此後將會按照此等條款或日後任何合法修訂條文建造的所有建築物，使其修繕妥當及狀況良好，並且在批租期屆滿或提前終止時以同等的保養狀態交還此等建築物。

(b) 如在批租期內任何時間拆卸建於該地段或其任何部份的現有建築物，承批人必須另建良好堅固的一座或多座同類型建築物而總樓面面積不小於現有建築物或有關類型和價值經署長批核的一座或多座建築物作替代。倘如上述拆卸建築物，承批人應在拆卸前1個曆月內向署長申請其同意在該地段進行重建工程。承批人接獲同意書後，必須在3個曆月內展開必要的重建工程，並在署長指定的期限內以署長滿意的方式完成重建。

6. 私家街道、道路及小巷

一般條款第8條

此等條款要求建造的任何私家街道、道路及巷道須設置於使署長滿意並由署長決定納入或不納入批租的土地。於上述任何一種情況下，承批人須在署長要求時免費交還給政府。如果上述街道、道路及小巷交還給政府，政府將進行鋪設路面、建造路緣、排水渠(污水及雨水排水渠)、渠道及路燈工程，費用由承批人承擔，其後則用公帑進行保養。如果上述私家街道、道路及小巷仍然是批租土地之部分，必須由承批人出資進行照明、鋪設路面、建造路緣、排水、開渠及保養工程，使署長在所有方面都滿意。為了公眾利益，署長需要時進行或促使他人進行路燈安裝與保養。承批人須承擔安裝路燈的建設成本並允許安裝與保養路燈的工人及車輛自由出入批租的範圍。

7. 綠色區域

特別條款第(5)(a)條

承批人須：

(i) 於2022年9月30日或在署長可能批准的其他日期或之前，自費並按署長批准的方式、物料、標準、水平、定線和設計進行下述工程，並在各方面使署長滿意：

- (I) 在批地文件所夾附的圖則上以綠色顯示的部份(「**綠色區域**」)鋪設及興建部份未來公共道路；及
- (II) 提供及建造該等橋樑、隧道、上跨路、下通道、下水道、高架道路、天橋、行人道、道路或署長自行酌情要求的其他構築物(「**該等構築物**」)；

使綠色區域內的建築、車輛、行人及單車的交通往來；

Summary of land grant

批地文件的摘要

(ii) 於2022年9月30日或在署長可能批准的其他日期或之前，自費在綠色區域鋪設路面、建造路緣及開水道，並提供署長規定的溝渠、污水渠、排水渠、消防栓連接駁至總水管的水管、街燈、交通標誌、街道設施、路面標記及植物，以達至署長滿意程度；及

(iii) 自費保養綠色區域連同該等構築物及在該區域之上或之內建造、安裝及提供的該等構築物、表面、溝渠、污水渠、排水渠、消防栓連接駁至總水管的水管、服務設施、街燈、交通標誌、街道設施、路面標記和植物，以達至署長滿意程度及直至綠色區域已根據批地文件特別條款第(6)條交回政府管有為止。

特別條款第(6)條

僅為了進行批地文件特別條款第(5)條指明的必要工程，綠色區域的管有權將會在批地文件訂立之日批予承批人。綠色區域或任何部分須於政府要求時交還給政府，而在任何情況下，承批人在署長發信表示此等條款已符合並使其滿意之日便當作已交還給政府。承批人須於所有合理時間在其管有綠色區域或任何部分期間，准許所有政府及公共車輛、行人及單車使用者自由進入、通過及經過綠色區域或其中部分，並確保該項進入的權利不受進行的工程干擾或阻礙，不論是按照批地文件的特別條款第(5)條或其他規定進行的工程。

特別條款第(7)條

承批人未獲得署長事先書面同意不可在綠色區域儲物或在該處搭建任何臨時構築物，或用作進行批地文件特別條款第(5)條指明的工程以外的其他用途。

8. 建築契諾

特別條款第(11)條

承批人須開發該地段，在該地段上興建建築物(專上學院(按批地文件特別條款第(22)(a)(i)條定義)除外)並於2022年9月30日或之前完工和使其適合佔用，在一切方面符合此等條款及目前或任何時候在香港實施有關建築、衛生及規劃的一切法例、附例及規例。

9. 保育樹木

特別條款第(13)條

未經署長事先書面同意，不得移除或干擾該地段或毗連範圍內生長的樹木。署長在發出書面同意時，對於樹木進行移植、補償性景觀美化工程或再植，附加他認為合適的條件。

10. 園景美化

特別條款第(14)條

(b) (ii) 該地段不少於30%面積須種植樹木、灌叢或其他植物。

(iii) 在批地文件特別條款第(14)(b)(ii)條所載的30%面積中不少於50%或署長可批准的其他百分比(以下簡稱「綠化範圍」)須在署長自行酌情指定的位置或樓層提供，讓行人可觀賞綠化範圍或進入該地段的任何人士可通行該處。

(c) 承批人須按已批准的園景設計總圖(「經批准的園景設計總圖」)自費美化該地段，在一切方面使署長滿意。未經署長的預先書面批准，不得對經批准的園景設計總圖進行修改、改變、更改、修訂或以另一圖則代替經批准的園景設計總圖。

(d) 承批人須在其後自費保持與保養園景工程處於安全、整潔、井然及衛生狀態，在一切方面達至署長滿意程度。

11. 發展條件

特別條款第(15)條

受限於此等條款的規定，該地段或其任何部份進行任何發展或重建工程(該詞指批地文件的一般條款第6條所述的重建工程)時：

(a) 承批人只能在該地段上搭建、建造、提供及保養下列樓宇及設施作為：

(i) 大圍站(按批地文件特別條款第28(a)條定義)；

(ii) (I) 私人住宅用途(「住宅樓宇」)，其總樓面面積不得少於114,288平方米和不得多於190,480平方米；

(iii) (II) 非工業用途(不包括私人住宅、倉庫、酒店及加油站)(「其他樓宇」)(包括單車停車場(按批地文件特別條款第20(a)條定義)及單車徑(按批地文件特別條款第21(a)條定義)，其總樓面面積不得少於37,200平方米和不得多於62,000平方米；

(III) 現有公廁(按批地文件特別條款第16(a)條定義)；

(IV) 現有公共交通交匯處(按批地文件特別條款第17(a)條定義)和新的公共交通交匯處(按批地文件特別條款第18(a)(i)條定義)；

(V) 單車停車場(按批地文件特別條款第20(a)條定義)和單車徑(按批地文件特別條款第21(a)條定義)，其總樓面積不得少於1,380平方米；

(VI) 專上學院(按批地文件特別條款第22(a)(i)條定義)，其總樓面面積為15,000平方米。

(d) 該地段已建或擬建任何一座或多座建築物的整體總樓面面積不得少於166,488平方米，亦不得多於267,480平方米(承批人同意及確認政府並不保證該地段或其任何部分已建或擬建的建築物可達到本特別條款第(a)(ii)(I)、(a)(ii)(II)及(d)分條提述的最大樓面面積)；

(e) 該地段已建或擬建任何建築物或其他構築物的任何部份連同其任何加建部份或裝置(如有)，總高度不得超出香港主水平基準以上199.8米或在承批人繳付經由署長決定之指定地價及行政費用後署長可自行酌情批准的其他高度限制，但是需取得署長事先書面批准才可以在建築物天台興建或擺放機房、冷氣機組、水箱、梯屋、天線及電訊設備、閃電保護裝置、建築維修機械及相類的構築物和設施(不包括公用空中花園)而超出上述高度限制。

(f) (i) 除非已取得署長事先書面批准，否則該地段已建或擬建的任何一座或一組建築物的建築面寬不得達至或超過60米。

Summary of land grant

批地文件的摘要

12. 現有公廁

特別條款第(16)條

- (a) 承批人確認目前在該地段的地面建有一個淨作業樓面面積不少於71.3平方米的公廁(該樓宇包括照明裝置、通風設備、抽氣管道及道路或地板表面，但不包括升降機、扶手電梯、樓梯、機械、設備及署長按此等條款可批准並非專供該地方的其他設施包括牆壁、支柱、橫樑、天花板、天台板、軌道、樓板及任何其他結構件)連同署長可全權酌情決定(其決定為最終決定並對承批人有約束力)專供該地方的任何其他區域、設施、服務及裝置，在下文稱為「現有公廁」)。政府對現有公廁的存在、運作及使用造成承批人或使其蒙受的任何損失、損害、滋擾或干擾毋須承擔任何責任。
- (b) 承批人不能干涉現有公廁的正常運作。未經取得食物環境衛生署署長的預先書面批准，不准進行可能影響現有公廁的正常運作之任何建築工程。
- (c) 政府特此保留權利並可全權酌情在任何時候更改或改變現有公廁或其中任何部分。
- (e) (i) 承批人須於批地文件約定的批租年期內的任何時候准許一切公眾人士為了合法目的自由及免付任何性質的費用進入、經過承批人指定的該地段的一個或多個部分和在其之上的任何建築物、構築物及搭建物之內、之下、之上或上面，以便不受阻礙出入現有公廁和毗鄰公共道路並使食物環境衛生署署長滿意。
- (g) 當承批人按批地文件特別條款第(3)條獲取該地段的管有權時，應當作為承批人交付現有公廁的管有權給政府，專供其使用、佔用及運作。
- (i) (i) 承批人須於批地文件約定的批租年期內，自費保養以下項目(「現有公廁項目」)，在一切方面使署長滿意：
- (I) 現有公廁的外部飾面和現有公廁之中、之內、周圍、內部、之上及之下的一切牆壁、支柱、橫樑、天花板、天台板、軌道或樓板的結構及任何其他結構件；
- (II) 供現有公廁和該地段的發展項目餘下部分的一切升降機、扶手電梯及樓梯；
- (III) 構成供現有公廁和該地段的發展項目餘下部分之部分系統的一切建築服務裝置、機械及設備(包括但不限於攜帶式和固定消防裝置設備)；
- (IV) 現有公廁下的一切結構板連同其內及其下的排水系統；及
- (V) 供現有公廁和該地段的發展項目餘下部分的一切其他公用部分及設施。
- (ii) 承批人須就其未能保養現有公廁項目而引致或導致一切任何性質的責任、賠償、開支、申索、成本、索償、費用、法律行動及程序彌償政府及財政司司長法團(按批地文件特別條款第(16)(h)(i)條定義)，並保證他們獲得彌償。
- (iii) 就本(i)分條而言，「承批人」一詞不包括財政司司長法團。

13. 現有公共運輸交匯處

特別條款第(17)條

- (a) 承批人確認目前在該地段的地面設有一個公共運輸交匯處(該樓宇(包括照明裝置、通風設備、抽氣管道及道路或地板表面，但不包括升降機、扶手電梯、樓梯、機械、設備及署長按此等條款可批准並非專供服務該地方的其他設施包括牆壁、支柱、橫樑、天花板、天台板、軌道、樓板及任何其他結構件)連同署長可全權酌情決定(其決定為最終決定並對承批人有約束力)專供服務該地方的任何其他區域、設施、服務及裝置，在下文稱為「現有公共運輸交匯處」)。政府對現有公共運輸交匯處的存在、運作及使用造成承批人或使其蒙受的任何損失、損害、滋擾或干擾毋須承擔任何責任。承批人須對承批人、他的僱工、工人及承辦商在現有公共運輸交匯處作出或不作出的任何事情所直接或間接產生或有關的一切責任、索償、費用、要求、訴訟及其他司法程序彌償政府並保證其獲得彌償。
- (b) 當承批人按批地文件特別條款第(3)條獲取該地段的管有權時，應當作為承批人交付現有公共運輸交匯處的管有權給政府，專供其使用、佔用及運作，但是不影響政府與承批人就保養現有公共運輸交匯處所達成的任何協議，直至按批地文件特別條款第(17)(g)條交還現有公共運輸交匯處的管有權給承批人。
- (c) 承批人須准許公眾使用現有公共運輸交匯處和不能干涉現有公共運輸交匯處的正常運作。未經取得運輸署署長的事先書面批准，不准進行可能影響現有公共運輸交匯處的正常運作之任何建築工程。
- (d) (i) 政府、其官員、代理人、承辦商、工人及其他正式授權人士享有一切權利並毋須支付任何費用進出及往返該地段或其中任何部分，旨在視察、檢查及監督承批人根據批地文件特別條款第(18)(a)條需要進行的任何工程和進行署長認為需要在現有公共運輸交匯處進行的任何工程。
- (ii) 政府、其官員、代理人、承辦商、工人及其他正式授權人士對他們行使批地文件特別條款第(17)(d)(i)條賦予的權利造成或附帶造成承批人或使其蒙受任何損失、損害、滋擾或干擾毋須承擔任何責任。承批人不能就上述損失、損害、滋擾或干擾起訴他們。
- (e) 政府在管有現有公共運輸交匯處期間具有絕對酌情權於任何時候決定公眾使用現有公共運輸交匯處或其中任何部分之事宜。
- (f) (i) 承批人須允許政府和公共車輛及行人通過該地段或其中任何部分，以便出入現有公共運輸交匯處。政府具有絕對權利按《道路交通條例》、《公共巴士服務條例》、其下的任何規例及任何修訂法例行使其權力。
- (g) 應署長要求，緊接在按批地文件特別條款第(18)(l)條交付新的公共運輸交匯處(按批地文件特別條款第(18)(a)(i)條定義)的空置管有權給政府或按批地文件特別條款第(18)(i)條轉讓新的公共運輸交匯處給財政司司長法團之前，以較早者為準，應視為交還現有公共運輸交匯處的管有權給承批人。

Summary of land grant

批地文件的摘要

14. 提供新的公共運輸交匯處

特別條款第(18)條

- (a) (i) 承批人須按此等條款及按批地文件特別條款第(18)(d)條批准的圖則以精工細作的方式在或將在該地段的表面上自費設計、搭建、建造及提供(包括對現有公共運輸交匯處進行一切必要的工程及更改工程和運輸署署長認為必要的其他工程)一個公共運輸交匯處，包括一個配有7條踞齒形巴士停車灣的巴士總站、1個平行巴士停車灣及6個平行巴士輪候車位、4個平行綠色專線小巴停車灣、1個平行普通上落客貨區、2個公共上落客貨區及1個的士候客區或運輸署署長可要求或批准的其他數量或設施，並保留一個淨作業樓面面積不少於45平方米的區域放置巴士營運者的輔助設施，並設有通道連接公用道路和提供輔助設施。上述項目須於2022年9月30日或之前或署長可決定(其決定為最終決定並對承批人有約束力)的較遲日期完成並使其適合佔用及運作及在一切方面使署長滿意，(該樓宇(包括照明裝置、通風設備、抽氣管道及道路或地的表面，但不包括升降機、扶手電梯、樓梯、機械、設備及署長按此等條款可批准並非專供該地方的其他設施、牆壁、支柱、橫樑、天花板、天台板、軌道、樓板及任何其他的結構件)連同署長可全權酌情決定(其決定為最終決定並對承批人有約束力)專供該地方的任何其他區域、設施、服務及裝置)，在下文稱為「新的公共運輸交匯處」)。
- (ii) 批地文件授予承批人進出現有公共運輸交匯處或其中任何部分，以便
- (I) 按批地文件特別條款第(18)(a)(i)條進行建築與完成新的公共運輸交匯處的工程或修補工程；
- (II) 按批地文件特別條款第(18)(a)(i)條進行運輸署署長認為必要的任何其他工程；及
- (III) 按批地文件特別條款第(19)(a)條和政府與承批人就建造新的公共運輸交匯處期間保養現有公共運輸交匯處所達成的任何協議要求保養現有公共運輸交匯處的工程；
- (iii) 承批人須對承批人、他的僱工、工人及承辦商在提供與建造新的公共運輸交匯處作出或不作出的任何事情所直接或間接引致或有關的一切責任、損害、開支、索償、費用、要求、收費、訴訟及司法程序彌償政府並保證其獲得彌償。
- (b) 政府特此保留權利可在任何時候有絕對酌情權更改或改變新的公共運輸交匯處或其中任何部分的用途。
- (j) (i) 承批人須對新的公共運輸交匯處(不論是工藝、材料、設計或其他方面)和為其提供的建築服務裝置(惟在批地文件之日在現有公共運輸交匯處已存在，但承批人沒有按批地文件特別條款第(18)(a)(i)條作出更改或修改的該等建築服務裝置、構築物、設施及建築物除外)的任何缺陷、失修、不完善、故障、失效或任何其他未完工程引致或有關的一切訴訟費用、要求、收費、損害賠償、訴訟及各種司法程序彌償政府和財政司司長法團並保證其獲得彌償，包括
- (I) 可能於承批人按批地文件特別條款第(18)(I)條交付新的公共運輸交匯處的管有權給政府之日已存在；及
- (II) 於承批人按批地文件特別條款第(18)(I)條移交新的公共運輸交匯處的管有權給政府之日後365天內發生或出現(「新的公共運輸交匯處的欠妥之處保養責任期」)。

- (ii) 應署長或財政司司長法團或兩者之要求，承批人須在署長財政司司長法團或兩者要求時按其要求的標準及方式自費進行維修、更改、重建及修補工程和其他必要的工程修補與糾正在新的公共運輸交匯處的欠妥之處保養責任期間產生或出現新的公共運輸交匯處和為其提供的建築服務裝置(惟在批地文件之日在現有公共運輸交匯處已存在，但承批人沒有按批地文件特別條款第(18)(a)(i)條作出更改或修改的該等建築服務裝置、構築物、設施及建築物除外)的任何缺陷、失修、不完善、故障、失效或任何其他未完工程。除此之外，承批人須在署長或財政司司長法團或兩者要求時按其要求的標準及方式自費彌補與糾正承批人在交付其管有權之日可能存在新的公共運輸交匯處和為其提供的建築服務裝置(惟在批地文件之日在現有公共運輸交匯處已存在，但承批人沒有按批地文件特別條款第(18)(a)(i)條作出更改或修改的該等建築服務裝置、構築物、設施及建築物除外)的任何缺陷、失修、不完善、故障、失效或任何其他未完工程。
- (iii) 署長或財政司司長法團或兩者將在快到新的公共運輸交匯處的欠妥之處保養責任期屆滿前，對新的公共運輸交匯處和為其提供的建築服務裝置(惟在批地文件之日在現有公共運輸交匯處已存在，但承批人沒有按批地文件特別條款第(18)(a)(i)條作出更改或修改的該等建築服務裝置、構築物、設施及建築物除外)進行視察，旨在確定任何缺陷、失修、不完善、故障、失效或任何其他未完工程的證據。署長和財政司司長法團各自保留權利在新的公共運輸交匯處的欠妥之處保養責任期結束後14天內向承批人發出一份或多份缺陷清單，列明新的公共運輸交匯處和為其提供的建築服務裝置(惟在批地文件之日在現有公共運輸交匯處已存在，但承批人沒有按批地文件特別條款第(18)(a)(i)條作出更改或修改的該等建築服務裝置、構築物、設施及建築物除外)的任何缺陷、失修、不完善、故障、失效或任何其他未完工程。承批人須在署長或財政司司長法團或兩者要求的時間內按其要求的標準及方式自費安排一切必要的工程，以便修補與糾正上述缺陷。
- (vi) 就本(j)分條而言，「**承批人**」一詞不包括他的受讓人。
- (m) (i) 在不影響批地文件特別條款第(18)(i)條的規定下，承批人須在所有時間自費保養新的公共運輸交匯處和為其提供的建築服務裝置(惟在批地文件之日在現有公共運輸交匯處已存在，但承批人沒有按批地文件特別條款第(18)(a)(i)條作出更改或修改的該等建築服務裝置、構築物、設施及建築物除外)處於修繕妥當的狀態，在一切方面使署長滿意，直至新的公共運輸交匯處的欠妥之處保養責任期結束。
- (ii) 就批地文件特別條款第(18)(m)(i)條而言，「**承批人**」一詞不包括他的受讓人。
- (n) (i) 此等條款保留一切權利給政府、其官員、代理人、承辦商、工人及正式授權的人士讓他們自由及免付任何費用進出及往返該地段或其中任何部分和新的公共運輸交匯處(在承批人管有新的公共運輸交匯處期間)，旨在視察、檢查及監督承批人需要在新的公共運輸交匯處進行的任何工程。
- (o) 應署長要求在按批地文件特別條款第(18)(I)條交付新的公共運輸交匯處的空置管有權給政府或按批地文件特別條款第(18)(i)條轉讓新的公共運輸交匯處給財政司司長法團之前(以較早者為準)，政府和財政司司長法團有權在新的公共運輸交匯處的一個指定地方(由署長與承批人協定)設置一個緊急逃生通道(「**緊急逃生通道**」)，承批人須自費在土地註冊處註冊一份經署長批准顯示緊急逃生通道的圖則。
- (q) (i) 承批人須在任何時候允許所有政府及公共車輛及行人交通不受限制及自由通過該地段或其中任何部分出入新的公共運輸交匯處。

Summary of land grant

批地文件的摘要

15. 保養現有公共運輸交匯處和新的公共運輸交匯處的牆壁之外的飾面及結構

特別條款第(19)條

- (a) 承批人須於批地文件約定的批租年期內，自費保養下列項目(「公共運輸交匯處項目」)，在一切方面使署長滿意：
- (i) 現有公共運輸交匯處和新的公共運輸交匯處的外飾面和現有公共運輸交匯處和新的公共運輸交匯處之中、之內、周圍、內部、之上及之下的一切牆壁、支柱、橫樑、天花板、天台板、軌道或樓板的結構及任何其他結構件；
 - (ii) 供現有公共運輸交匯處和新的公共運輸交匯處或兩者及該地段的發展項目餘下部分的一切升降機、扶手電梯及樓梯；
 - (iii) 構成供現有公共運輸交匯處或新的公共運輸交匯處或兩者及該地段的發展項目餘下部分的系統之部分的一切建築服務裝置、機械及設備(包括但不限於手攜式及固定消防裝置設備)；
 - (iv) 現有公共運輸交匯處和新的公共運輸交匯處或兩者下面的一切結構板連同其內或其下的排水系統；
 - (v) 供現有公共運輸交匯處和新的公共運輸交匯處或兩者及該地段的發展項目餘下部分的一切其他公用地方及設施。
- (c) 就批地文件特別條款第(19)條而言，「承批人」一詞不包括財政司司長法團。

16. 提供單車停車場

特別條款第(20)條

- (a) 承批人須在2022年9月30日之前或署長可指定的期限內按署長可批准的條件在新的公共運輸交匯處附近的位置或署長可決定的其他位置自費以精工細作的方式搭建與建造和其後保養與管理一個單車停車場(「單車停車場」)，其範圍涵蓋330個停車位或署長可批准的其他數目，供公眾停泊單車。承批人須在展開工程之前提交或促使他人提交詳細的設計建議給運輸署長作書面批核。
- (c) 承批人須於批地文件約定的批租年期內，保持單車停車場每日24小時開放給公眾使用，除臨時關閉單車停車場或其中任何部分以便進行保養工程。
- (g) 就批地文件特別條款第(20)條而言，「承批人」一詞不包括財政司司長法團。

17. 提供單車徑

特別條款第(21)條

- (a) 承批人須在2022年9月30日之前或署長可指定的期限內按署長可批准的條件自費提供和其後保養與管理一條淨寬度不少於3.5米的單車徑(「單車徑」)，以便銜接單車停車場和毗鄰的單車徑，確保延續沙田新市鎮的單車徑網絡。

- (e) 承批人須於批地文件約定的批租年期內，保持單車徑每日24小時開放給單車使用者(不論是否騎著單車)不受阻礙地經過及再經過單車徑。

- (i) 就批地文件特別條款第(21)條而言，「承批人」一詞不包括財政司司長法團。

18. 提供專上學院

特別條款第(22)條

- (a) (i) 承批人須按批地文件特別條款第(22)(c)條規定和教育局局長與承批人協定的規格(「規格」)在該地段內自費以精工細作的方式設計、搭建、建造及提供一個總樓面面積為15,000平方米的專上學院連同批地文件特別條款第(43)(c)和(43)(e)(i)(iii)條規定的8個車輛停車位和5個電單車停車位(統稱「專上學院」)，在一切方面使教育局局長滿意。
- (ii) 承批人須在2020年3月31日之前或教育局局長與承批人協定的較遲日期完成專上學院的結構外殼及外正面連同8個車輛停車位和5個電單車停車位。
- (iii) 即使批地文件特別條款第(22)(a)(i)條規定，如果承批人未能在批地文件之日起36個曆月內與教育局局長就規格達成協議，承批人須立即在批地文件特別條款第(22)(a)(ii)條指定的期限或之前按教育局局長已批准或擬批准的設計及平面圖(包括其後任何修訂)在該地段內以精工細作的方式建造與提供專上學院，在一切方面使教育局局長滿意。
- (iv) 承批人須自費保養及管理專上學院及在其中、其內及其下的所有物件，使其保持良好狀態及達至署長滿意程度，直至專上學院已根據批地文件特別條款第(22)(m)條交回政府管有或根據批地文件特別條款第(22)(h)條轉讓予財政司司長法團(以較早者為準)為止。
- (b) 政府特此保留權利在任何時候有絕對酌情權更改或改變專上學院或其中任何部分的用途。
- (i) (i) 承批人須對專上學院(不論是工藝、材料、設計或其他方面)的任何缺陷、失修、不完善、故障、失效或任何其他未完工程引致或有關的一切訴訟費用、要求，收費、損害賠償、訴訟及各種司法程序彌償政府和財政司司長法團並保證其獲得彌償，包括
- (I) 可能於承批人按批地文件特別條款第(22)(m)條交付專上學院的管有權給政府之日已存在；及
 - (II) 於承批人按批地文件特別條款第(22)(m)條交付專上學院的管有權給政府之日後365天內發生或出現(「專上學院的欠妥之處保養責任期」)。
- (ii) 應署長或財政司司長法團或兩者之要求，承批人須在署長或財政司司長法團或兩者要求時按其要求的時限、標準及方式自費進行維修、更改、重建及修補工程和其他必要的工程以修補與糾正在專上學院的欠妥之處保養責任期間產生或出現於專上學院的任何缺陷、失修、不完善、故障、失效或任何其他未完工程。除此之外，承批人須在署長或財政司司長法團或兩者要求時按其要求的時限、標準及方式自費彌補與糾正承批人在交付其管有權之日可能存在專上學院的任何缺陷、失修、不完善、故障、失效或任何其他未完工程。

Summary of land grant

批地文件的摘要

(iii) 署長或財政司司長法團或兩者將在快到專上學院的欠妥之處保養責任期屆滿前，對專上學院進行視察，旨在確定任何缺陷、失修、不完善、故障、失效或任何其他未完工程的證據。署長和財政司司長法團各自保留權利在專上學院的欠妥之處保養責任期結束後14天內向承批人發出一份或多份缺陷清單，列明專上學院的任何缺陷、失修、不完善、故障、失效或任何其他未完工程。承批人須在署長或財政司司長法團或兩者要求時按其要求的標準及方式自費安排一切必要的工程以便修補與糾正上述缺陷。

(vi) 就本(i)分條而言，「**承批人**」一詞不包括他的受讓人。

(k) (i) 在不影響批地文件特別條款第(22)(i)條的規定下，承批人須自費保養專上學院處於修繕妥當的狀態，在一切方面使署長滿意，直至專上學院的欠妥之處保養責任期結束。

(ii) 就批地文件特別條款第(22)(k)(i)條而言，「**承批人**」一詞不包括他的受讓人。

(l) (i) 承批人須於批地文件約定的批租年期內，自費保養下列項目(「**專上學院項目**」)，在一切方面使署長滿意：

(i) 專上學院的外飾面和專上學院之中、之內、周圍、內部、之上及之下的一切牆壁、支柱、橫樑、天花板、天台板、軌道或樓板的結構及任何其他結構件；

(ii) 供專上學院和該地段的發展項目餘下部分的一切升降機、扶手電梯及樓梯；

(iii) 構成供專上學院和該地段的發展項目餘下部分的系統之部分的一切建築服務裝置、機械及設備(包括但不限於手攜式及固定消防裝置設備)；

(iv) 專上學院下面的一切結構板連同其內或其下的排水系統；

(v) 供專上學院和該地段的發展項目餘下部分的一切其他公用地方及設施。

(ii) 承批人須就其未能保養專上學院項目而引致或導致一切任何性質的責任、賠償、開支、申索、成本、索償、費用、法律行動及程序彌償政府及財政司司長法團，並保證他們獲得彌償。

(iii) 就本(l)分條而言，「**承批人**」一詞不包括財政司司長法團。

19. 提供售樓處和示範單位

特別條款第(23)條

即使批地文件特別條款第(15)(a)(ii)和(15)(d)條准許最大總樓面面積，承批人可在該地段的部分搭建獨立的臨時構築物，作為售樓處和示範單位及相關的市場推銷活動，以協助按此等條件在該地段已建或擬建的建築物或其中任何部分的銷售，但是上述售樓處和示範單位及相關的市場推銷活動的運作範圍及期限須取得署長的預先書面批准。

20. 康樂設施

特別條款第(24)(a)條

(i) 承批人可在該地段興建、建造及提供經署長書面批准的康樂設施和該處的附屬設施(以下簡稱「**設施**」)。設施的類型、大小、設計、高度和佈局事前必須獲得署長書面批核

(iii) 倘若設施的任何部份可獲豁免而不計入批地文件特別條款第(24)(a)(ii)條所訂的總樓面面積(以下簡稱「**豁免設施**」)：

(i) 豁免設施須訂為批地文件特別條款第(40)(a)(v)條所訂的公用地方之一部份；

(ii) 承批人應自費維修豁免設施，以保持其修繕妥當及良好狀況，同時妥善運作該豁免設施，使署長滿意；及

(iii) 豁免設施只可供現已或將會建於該地段的一座或多座住宅大廈住戶和其真正訪客使用，其他人士不可使用。

21. 休憩地方

特別條款第(24)(b)條

(i) 承批人須在該地段內自費提供一個總面積不少於8,500平方米或署長書面批准的其他面積的休憩地方(「**休憩地方**」)，該地方須按署長可不時要求或批准的標準安置、平整、服務、美化、種植、處理及提供設備及設施，在一切方面使署長滿意。

(ii) 休憩地方只能供該地段上已建或擬建的建築物的住戶和他們的真正來賓或訪客作妥善使用與享用該地段的康樂用途。

(iii) 承批人須於批地文件約定的批租年期內自費保養休憩地方使其處於修繕妥當的狀態，在一切方面使署長滿意。

(iv) 休憩地方須指定為及構成批地文件特別條款第(40)(a)(v)條所載的公用地方之一部份。

22. 鐵路構築物和保護裝置

特別條款第(32)條

(a) 在該地段展開任何工程包括但不限於地盤勘測、打樁或其他地基工程及其他土木及建築工程之前，承批人須諮詢香港鐵路有限公司(按批地文件特別條款第(29)(c)條定義)，確保上述任何工程沒有損壞、干涉、阻塞或危及該地段或其中任何部分之內、經過或附近的九廣鐵路、大圍站或九廣鐵路有關的其他鐵路工程、構築物、設施或裝置(大圍站鐵路工程、構築物、設施及裝置在下文統稱為「**鐵路構築物及裝置**」)的安全或營運(署長對此作出的決定是最終決定)。如果署長要求，承批人須自費採取香港鐵路有限公司要求的措施及預防措施以確保九廣鐵路和鐵路構築物及裝置的安全及營運。

Summary of land grant

批地文件的摘要

- (b) 承批人須遵守有關九廣鐵路和鐵路構築物及裝置的一切條例、附例及規例。
- (c) 承批人不能以任何方式干涉九廣鐵路和鐵路構築物及裝置的建造、使用及營運。
- (d) 承批人須自費履行建築事務監督、消防處處長及一切其他有關政府及法定當局對連接或毗鄰九廣鐵路和鐵路構築物及裝置的任何建築物的建築(包括使用的材料)、維修及保養的一切特別要求。
- (e) 承批人須於批地文件約定的批租年期內遵守與履行屋宇署署長不時對保護九廣鐵路和鐵路構築物及裝置所施加的一切要求並使屋宇署署長滿意。
- (f) 除批地文件特別條款第(32)(g)條規定外，當條例(按批地文件特別條款第(29)(c)(iv)(I)(B)條定義)第4條授予的特許權(包括其延期)被撤銷或期滿或服務特許權協議(按批地文件特別條款第(29)(c)條定義)終止或期滿，而香港鐵路有限公司不再營運九廣鐵路或九廣鐵路影響該地段的部分，在批地文件特別條款第(32)條中對香港鐵路有限公司的提述應指九廣鐵路公司。
- (g) 當條例第4條授予的特許權(包括其延期)被撤銷或期滿，香港鐵路有限公司不再營運九廣鐵路或九廣鐵路影響該地段的部分，而政府、其提名人或政府指定的第三方按條例第19A(2)條接管九廣鐵路或九廣鐵路影響該地段的部分，在批地文件特別條款第(32)條中對香港鐵路有限公司的提述(如適用)應指政府、其提名人或政府指定的第三方。

23. 政府進入大圍站

特別條款第(33)(a)條

承批人須於批地文件約定的批租年期內准許政府、其官員、傭工、代理人及他們授權的任何人士有權(經提前不少於14天預先通知，緊急情況除外)於任何合理時間攜帶或不攜帶工具、車輛或設備自由進出及往返該地段和在該地段上已建或擬建的任何建築物，旨在視察鐵路構築物及裝置和公共道路及公路構築物或其中任何部分。

24. 公眾進入大圍站

特別條款第(34)條

承批人須於批地文件約定的批租年期內准許任何公眾人士在大圍站正常營運期間為了一切合法目的徒步或乘坐輪椅或帶同各類車輛(如適用)自由及毋須支付任何性質的費用進出和通過承批人指定該地段或在該地段之內、之下、之上或上方的任何建築物、構築物及搭建物之部分，以便出入大圍站。

25. 建造有蓋行人天橋

特別條款第(35)條

- (a) 承批人須在2022年9月30日或之前或署長可指定的期限內按署長批准的條件自費建造下列項目，在一切方面使署長滿意：
 - (i) 在批地文件所夾附的圖則上顯示與註明“**PROPOSED FB 1**”和“**PROPOSED FB 2**”的大約位置搭建、建造及提供署長要求或批准的2座單層有蓋行人天橋連同其一切支撐物及連接段(包括署長有絕對酌情權認為必要為有蓋行人天橋的未來連接段的任何支撐物及連接物)(統稱「**有蓋行人天橋**」)，以便行人可通過有蓋行人天橋出入行人通道(按批地文件特別條款第(36)(a)條定義)。有蓋行人天橋須按署長要求與批准的材料、標準、水平、定線、佈局及設計建造，包括但不限於提供與建造支撐物、斜道、輔助樓梯及梯台、扶手電梯、升降機，傷殘人士用斜道或升降機和署長自行酌情要求的內部及外部固定物及附著物及照明裝置。每座有蓋行人天橋的內部淨寬度須有不少於6.0米或運輸署署長可批准的其他寬度和2.6米的內部最低淨空高度。
 - (ii) 按署長要求或批准修改在批地文件所夾附的圖則上顯示並註明“**EXISTING FB**”的現有行人天橋連同一切支撐物及連接物(包括署長有絕對酌情權認為必要為現有行人天橋的未來連接段的任何支撐物及連接物)(統稱「**現有行人天橋的支撐物、連接物及延伸物**」)，以便行人及單車使用者可經過現有行人天橋出入行人通道(按批地文件特別條款第(36)(a)條定義)。現有行人天橋的修改與延長須包括提供1條2.8米寬或運輸署署長可決定的其他寬度的單車徑。現有行人天橋支撐物、連接物及延伸物須按署長要求與批准的材料、規格、標準、水平、定線、佈局、設計及位置建造，包括但不限於提供與建造支撐物、斜道、輔助樓梯及梯台、扶手電梯、升降機，傷殘人士用斜道或升降機和署長自行酌情要求的內部及外部固定物及附著物及照明裝置。
- (c) 即使此等條款有任何相反的規定，承批人須於批地文件約定的批租年期內自費維修、管理及保養有蓋行人天橋和現有行人天橋支撐物、連接物、延伸物及承批人按批地文件特別條款第(35)(g)條可能建造的任何替代物處於清潔、井然及良好的維修及狀態，在一切方面使署長滿意。
- (e)
 - (i) 不能使用有蓋行人天橋和現有行人天橋的支撐物、連接物及延伸物作一切公眾人士徒步或乘坐輪椅或單車通過以外的其他用途。
 - (ii) 除非署長另作批准或要求，承批人不能使用或准許或容許他人使用有蓋行人天橋和現有行人天橋的支撐物、連接物及延伸物的外部或內部作廣告或展示任何標誌、通告或各種海報。
 - (iii) 承批人不能在有蓋行人天橋和現有行人天橋的支撐物、連接物及延伸物作出或准許或容許他人作出任何事情以致對經過有蓋行人天橋和現有行人天橋的支撐物、連接物及延伸物下面的任何人員或車輛或毗鄰或附近的地段或物業的任何業主或佔用人造成滋擾、煩擾、不便或損害。
 - (iv) 承批人須在有蓋行人天橋存在的整個期間准許一切公眾人士為了合法目的每日24小時自由及免付任何費用不受阻礙地徒步或乘坐輪椅或騎單車經過、再經過、上落有蓋行人天橋。
 - (v) 承批人須在現有行人天橋的支撐物、連接物及延伸物存在的整個期間准許一切公眾人士為了合法目的每日24小時自由及免付任何費用不受阻礙地徒步或乘坐輪椅或騎單車經過、再經過、上落現有行人天橋的支撐物、連接物及延伸物。

Summary of land grant

批地文件的摘要

- (g) 倘若重建該地段或其中任何部分或其他原因而需要拆除有蓋行人天橋或現有行人天橋的支撐物、連接物及延伸物，承批人須在署長規定的期限內按署長批准或要求的方式、設計、材料、寬度、水平、標準、定線及佈局自費建築與完成新的有蓋行人天橋或現有行人天橋或其中任何部分的新的支撐物、連接物及延伸物作為替代，使署長滿意。
- (h) 批地文件保留給政府、其官員、代理人、承辦商、工人及其他正式授權人士及毋須支付任何費用：
- (i) 為了於現有行人天橋的外部及該地段內搭建、安裝、維修及保養署長(其意見將為最終論並對承批人有約束力)認為規管車輛及行人交通所必要的街燈、交通標誌、交通信號及其他設備的一切必要進出及往返該地段的權利。
- (ii) 一切必要進出及往返該地段的權利，旨在視察、檢查、監督、管理、保持、維修及保養現有行人天橋和進行重建或翻新所必要的勘測及測量工作。
- (iii) 連接現有行人天橋至現有行人天橋的支撐物、連接物及延伸物的權利。
- (l) 如果承批人進行的建築工程影響出入現有行人天橋，承批人須自費提供臨時通道供公眾於每日24小時免付任何費用、不受阻礙地出入現有行人天橋，使運輸署署長滿意。
- (m) 就批地文件特別條款第(35)條而言，「承批人」一詞不包括財政司司長法團。

26. 連接建築物及設施的行人通道

特別條款第(36)條

- (a) 承批人須按署長要求或批准的位置、方式、材料、標準、水平、定線及設計在該地段內在其上已建或擬建的任何建築物自費鋪設、構築、提供、建造及鋪蓋獨立行人道或徑(連同署長絕對酌情要求的樓梯、斜道、照明、通風、乘客升降機、扶手電梯及行人天橋承托物)作批地文件特別條款第(36)(b)條指定的用途，在一切方面使署長滿意。上述獨立行人道或徑連同樓梯、斜道、照明、通風、乘客升降機、扶手電梯及行人天橋承托物在下文統稱為「**行人通道**」)。
- (b) 行人通道須採用最短路徑並加上蓋和為下述目的建造及設計：
- (i) 在署長要求或批准的建築物之位置及樓層連接擬在該地段興建的各建築物；
- (ii) 在署長可要求或批准的位置及樓層連接該地段內的一切主要設施，包括大圍站、住宅樓宇、其他樓宇、現有公廁、現有公共運輸交匯處、新的公共運輸交匯處、單車停車場、單車徑、專上學院、有蓋行人天橋、現有行人天橋、批地文件特別條款第(49)(a)條提述的專上學院停車處、批地文件特別條款第(50)(a)條提述的公共停車處及休憩地方。
- (c) 承批人須於批地文件約定的批租年期內自費管理與保養行人通道處於修繕妥當的狀態，使署長滿意。

- (d) (i) 承批人須在該地段及其上面已建或擬建的任何建築物內設計與提供和其後管理與保養一條行人道，包括署長要求或批准的扶手電梯、乘客升降機、樓梯、斜道及其他構築物(該行人道在下文稱為「**24小時行人道**」)，以便連接大圍站、現有公廁、現有公共運輸交匯處、新的公共運輸交匯處、單車停車場、單車徑、專上學院、有蓋行人天橋、現有行人天橋、批地文件特別條款第(49)(a)條提述的專上學院停車處、批地文件特別條款第(50)(a)條提述的公共停車處、該地段的地面和毗鄰該地段的街道水平行人徑，在一切方面使署長滿意。承批人須提交一份顯示24小時行人道的路徑圖則給署長批核。署長就甚麼構成該地段的地面水平和街道水平的決定是最終決定並對承批人有約束力。
- (ii) 24小時行人道(不包括扶手電梯、乘客升降機、樓梯、斜道及其他構築物)須有不少於4.5米的內部淨寬度。
- (e) 承批人須於批地文件約定的批租年期內保持24小時行人道開放給公眾為了合法目的每日24小時徒步或乘坐輪椅免付任何費用、不受阻礙地使用。承批人須自費保持按批地文件特別條款第(36)(d)(i)條提供的扶手電梯和乘客升降機每日24小時運作，使署長滿意。
- (i) 就批地文件特別條款第(36)條而言，「**承批人**」一詞不包括財政司司長法團。

27. 泊車和上落貨規定

特別條款第(43)條

- (a) (i) 除非署長同意按有異於下述表格規定的比率或數目提供住宅停車位，承批人必須按批地文件特別條款第(43)(a)(i)條內的表格列明在該地段已建或擬建的住宅單位尺寸計算的比率在該地段內提供停車位(「住宅停車位」)用作停泊《道路交通條例》、該條例下任何規例及任何修訂法例獲發牌並屬於該地段內已建或擬建的建築物內住宅單位的住戶和他們的真正來賓、訪客或被邀請者的車輛並使署長滿意。
- (iii) (I) 如果在該地段已建或擬建的任何住宅單位大廈有超過75個住宅單位，承批人必須提供額外停車位，用作停泊《道路交通條例》、該條例下任何規例及任何修訂法例獲發牌並屬於該地段已建或擬建建築物的住宅單位住戶的真正來賓、訪客或被邀請者的車輛。該停車位須按上述每座住宅單位大廈5個停車位之比率或署長可批准的其他比率提供，惟須提供至少2個停車位。
- (II) 如果在該地段已建或擬建的任何住宅單位大廈有75個或少於75個住宅單位，承批人必須提供額外停車位，用作停泊《道路交通條例》、該條例下任何規例及任何修訂法例獲發牌並屬於該地段已建或擬建建築物的住宅單位住戶的真正來賓、訪客或被邀請者的車輛。該停車位須按上述每座住宅單位大廈1個停車位之比率或署長可批准的其他比率提供，惟須提供至少2個停車位。
- (iv) 按批地文件特別條款第(43)(a)(i)及(a)(iii)條(可按批地文件特別條款第(45)條作出修訂)提供的停車位只能用作該等條件指定的用途。該等停車位不能用作儲存、展示或陳列車輛作出售或其他用途或汽車清潔及美容服務。

Summary of land grant

批地文件的摘要

- (b) (i) 除非署長同意其他比率，停車位必須根據該地段已建或擬建的建築物的總樓面面積每200平方米或其中部分1個停車位之比率提供給其他樓宇使用並使署長滿意。
- (ii) 除按批地文件特別條款第(43)(b)(i)條提供的停車位外，承批人須在該地段內為其他樓宇提供80個停車位並使署長滿意。
- (iv) 按批地文件特別條款第(43)(b)(i)及(b)(ii)條(可按批地文件特別條款第(45)條作出修訂)提供的停車位只能用作停泊《道路交通條例》、該條例下任何規例及任何修訂法例獲發牌並屬於該地段已建或擬建建築物的佔用人和他們的真正來賓、訪客或被邀請者的車輛。該等停車位不能用作儲存、展示或陳列車輛作出售或其他用途或汽車清潔及美容服務。
- (c) 必須在該地段內提供8個停車位並使署長滿意，用作停泊《道路交通條例》、該條例下任何規例及任何修訂法例獲發許可並屬於專上學院的佔用人和他們真正的來賓、訪客或被邀請者的車輛的用途。該等停車位不能用作儲存、展示或陳列車輛作出售或其他用途或汽車清潔及美容服務。
- (d) (i) 承批人須從批地文件特別條款(43)(a)(i)、(a)(iii)、(b)(i)及(b)(ii)條(可按批地文件特別條款第(45)條作出修訂)和特別條款(43)條(c)條提供的停車位中保留與指定停車位，用作《道路交通條例》、該條例下任何規例及修訂法定義的傷殘人士停泊車輛之用途(「**傷殘人士停車位**」)，該等停車位須按建築事務監督的要求及批准的比率提供，惟須從批地文件特別條款(43)(a)(iii)條(可按批地文件特別條款第(45)條作出修訂)提供的停車位中保留與指定至少1個停車位。承批人不能指定或保留批地文件特別條款(43)(a)(iii)條(可按批地文件特別條款第(45)條作出修訂)提供的所有停車位作為傷殘人士停車位。
- (ii) 傷殘人士停車位只能停泊傷殘人士的車輛並根據《道路交通條例》、該條例下任何規例及任何修訂法例定義的傷殘人士停泊的單位屬於該地段已建或擬建建築物的住戶或佔用人和他們的真正來賓、訪客或被邀請者的車輛。該等停車位不能用作儲存、展示或陳列車輛作出售或其他用途或汽車清潔及美容服務。
- (e) (i) 除非署長同意其他比率，承批人必須按下列比率在該地段內提供停車位以停泊《道路交通條例》、該條例下任何規例及任何修訂法例獲發出許可的電單車並使署長滿意：
- (I) 批地文件特別條款第(43)(a)(i)條(可按批地文件特別條款第(45)條作出修訂)要求提供的住宅停車位和批地文件特別條款第(43)(a)(iii)條(可按批地文件特別條款第(45)條作出修訂)要求提供的停車位的總數的百分之十(「住宅電單車停車位」)；
- (II) 批地文件特別條款第(43)(b)(i)和(b)(ii)條(可按批地文件特別條款第(45)條作出修訂)要求提供的停車位總數的百分之十；
- (III) 專上學院有5個停車位但如果提供的停車位數目是小數，應四捨五入化為整數。
- (ii) 住宅電單車停車位只能用作停泊《道路交通條例》、該條例下任何規例及任何修訂法例獲發牌並屬於該地段已建或擬建建築物的住宅單位的住戶和他們的真正來賓、訪客或被邀請者的電單車。該等停車位不能用作儲存、展示或陳列車輛作出售或其他用途或汽車清潔及美容服務。

- (iii) 按批地文件特別條款第(43)(e)(i)(II)條提供的停車位只能用作批地文件特別條款第(43)(b)(i)和(b)(ii)條指定停泊《道路交通條例》、該條例下任何規例及任何修訂法例獲發牌並屬於該地段已建或擬建建築物的佔用人和他們的真正來賓、訪客或被邀請者的電單車。該等停車位不能用作儲存、展示或陳列車輛作出售或其他用途或汽車清潔及美容服務。
- (iv) 按批地文件特別條款第(43)(e)(i)(III)條提供的停車位只能用作停泊《道路交通條例》、該條例下任何規例及任何修訂法例獲發牌並屬於專上學院的佔用人和他們真正的來賓、訪客或被邀請者的電單車。該等停車位不能用作儲存、展示或陳列車輛作出售或其他用途或汽車清潔及美容服務。
- (f) 必須按每20個住宅單位或其中部分(每個住宅單位的面積少於70平方米)之比率或署長批准的其他比率在該地段內提供停車位，用作停泊屬於該地段已建或擬建建築物的住宅單位的住戶和他們的真正來賓、訪客或被邀請者的單車的用途並使署長滿意。

特別條款第(44)條

- (a) 除非署長同意其他比率或數目，必須按下列比率或數目在該地段內提供上落貨車停車位並使署長滿意：
- (i) (I) 如果在該地段已建或擬建的任何住宅單位大廈有超過75個住宅單位，必須在該地段已建或擬建的每座住宅單位大廈提供至少1個上落貨車停車位，此等上落貨車停車位應設於每座住宅單位大廈範圍內或毗連該處；
- (II) 如果在該地段已建或擬建的任何住宅單位大廈有75個或少於75個住宅單位，必須在該地段已建或擬建的所有住宅單位大廈提供至少2個上落貨車停車位，此等上落貨車停車位應設於該等住宅單位大廈範圍內或毗連該處；
- (ii) 必須根據該地段已建或擬建的建築物的總樓面面積每1,200平方米或其中部分1個停車位之比率提供給其他樓宇使用。
- (b) 根據該等條件，上述停車位只供貨車上落貨於指定有關的建築物。

特別條款第(47)條

- (a) 即使承批人已按署長滿意的方式履行和遵守此等條款，住宅停車位及住宅電單車停車位不得：
- (i) 轉讓，除非：
- (I) 連同賦予獨有使用與管有權於該地段已建或擬建的一座或多座建築物之一個或多個住宅單位的不分割份數(按批地文件特別條款第(4)(a)條定義)一併轉讓；或
- (II) 給予現時已擁有獨有使用與管有權於該地段已建或擬建的一座或多座建築物之一個或多個住宅單位的不分割份數的人士；或

Summary of land grant

批地文件的摘要

(ii) 分租(租予該地段已建或擬建一座或多座建築物內之住宅單位的住戶除外)。

於任何情況下不可轉讓多過總共3個住宅停車位及住宅電單車停車位予該地段已建或擬建一座或多座建築物內之任何一個住宅單位的業主或分租多過總共三個此等停車位予任何一個住宅單位的住戶。

(d) 批地文件特別條款第(47)(a)條不適用於傷殘人士停車位。

特別條款第(48)條

在該地段內按批地文件特別條款第(43)(a)(iii)條(可按批地文件特別條款第(45)條修訂)的停車位、傷殘人士停車位及按批地文件特別條款第(43)(f)和(44)(a)條提供的停車位須指定並構成公用地方之一部分。

28. 提供專上學院停車處

特別條款第(49)條

(a) 承批人須在2022年9月30日或之前或署長可指定的其他期限按署長可批准的條件在該地段的地面水平(署長就甚麼構成該地段的地面水平和街道水平的決定是最終決定並對承批人有約束力)提供和其後管理與保養1個尺寸為3.5米寬、11.0米長、最低淨空高度為4.7米的停車處和不少於1個尺寸為2.5米寬、40米總長、最低淨空高度為2.4米的停車處，供與專上學院有關的車輛(包括的士)上落客之用(統稱為「**專上學院停車處**」)。

(e) 根據批地文件特別條款第(49)(a)條於該地段內提供的專上學院停車處須指定為及構成公用地方之一部分。

(f) 承批人須於批地文件約定的批租年期內並保持專上學院停車處開放給專上學院的佔用人和他們的真正來賓、訪客或被邀請者每日24小時免費不受阻礙地使用並使署長滿意。

29. 提供公共停車處

特別條款第(50)條

(a) 承批人須在2022年9月30日或之前或署長可指定的其他期限按署長可批准的條件在翠田街與車公廟道交匯處旁邊該地段的地面水平或署長指定的其他地點(署長就甚麼構成該地段的地面水平的決定是最終決定並對承批人有約束力)提供和其後管理與保養不少於1個尺寸為3.5米寬及40.0米總長的公共停車處，供車輛(包括的士)上落客之用(「**公共停車處**」)。承批人須在展開建築工程之前提交或促使他人提交詳細的公共停車處設計建議給運輸署長作書面批核。

(e) 根據批地文件特別條款第(50)(a)條於該地段內提供的公共停車處須指定為及構成公用地方之一部分。

(f) 承批人須於批地文件約定的批租年期內保持公共停車處開放給公眾每日24小時免費、不受阻礙地使用並使署長滿意。

30. 垃圾收集站

特別條款第(52)條

(a) 承批人須自費提供、建造及保養一個垃圾收集綜合系統以收集該地段已建或擬建建築物各樓層的垃圾並在在一切方面使食物環境衛生署署長滿意。

(b) (i) 承批人須於食物環境衛生署署長決定的日期在該地段內按署長批准的材料、標準、設計及位置自費提供、建造及其後保養一個垃圾收集站(「**垃圾收集站**」)和署長根據經批准建築圖則可批准或要求供垃圾收集車輛停泊和裝卸用的停車位(不能少於一個停車位)並使署長滿意。

(iii) (i) 根據批地文件特別條款第(52)(b)(i)條提供給垃圾收集車輛停泊和裝卸用的停車位只能用作垃圾收集車停泊和裝卸的用途。

31. 削去土地

特別條款第(54)條

(a) 如果任何土地已經或需要被削去、消除或後移或堆積或堆填或進行任何類型的斜坡處理工程，不論是否經署長事先書面同意，亦不論是在該地段內或任何政府土地內，旨在或有關於構建、平整或開發該地段或其任何部份或承批人按批地文件需要進行的任何其他工程，或作任何其他用途，承批人須自費進行和建設該等斜坡處理工程、護土牆或其他承托物、保護物、排水或輔助工程或今後成為必要的其他工程，以便保護和承托該地段和任何毗鄰或毗連政府土地或已出租土地內的土地及避免和防止其後發生的任何倒塌、山泥傾瀉或地陷。承批人須於批地文件約定的批租年期內的所有時間自費保養該土地、斜坡處理工程、護土牆或其他承托物、保護物、排水或輔助工程或其他工程使其處於良好修葺的狀態，以至署長滿意。

(c) 倘若因為任何構建、平整、開發或承批人進行其他工程或任何其他原因而引起倒塌、山泥傾瀉或地陷，不論發生在或來自該地段任何土地或任何毗鄰或毗連政府土地或已出租土地，承批人須自費進行修復至原狀以至署長滿意並對上述倒塌、山泥傾瀉或地陷造成政府、其代理及承辦商承受、遭受或產生的各種費用、收費、損害賠償、要求及申索作出彌償。

(d) 除了就違反批地文件的條款權利或補償外，署長有權發出書面通知承批人進行、建造及保養該土地、斜坡處理工程、護土牆或其他承托物、保護物及排水或輔助工程或其他工程或恢復與彌補任何倒塌、山泥傾瀉或地陷。

32. 維修地錨

特別條款第(56)條

如該地段的發展或重建項目或其任何部份已安裝預應力地錨，承批人須自費在預應力地錨的整個使用周期內定期維修和監察，以令署長滿意，並且在署長不時絕對酌情要求時提交上述監察工程的報告和資料。

Summary of land grant 批地文件的摘要

33. 泥石或瓦礫

特別條款第(57)條

- (a) 倘若來自該地段或受該地段任何發展項目影響的其他地方的泥土、廢石方、瓦礫、建築廢料或建築材料(以下簡稱「廢物」)被侵蝕、沖刷或傾倒到公共通道或道路或排入道路暗渠、前灘或海床、污水渠、雨水渠、排水渠、明渠或其他政府物業(以下簡稱「政府的物業」)，承批人須自費清理該等廢物並為對政府的物業所造成的任何損壞作出彌補。承批人須對上述的侵蝕、沖刷或傾倒而造成私人物業所造成的任何損壞或滋擾所產生的一切訴訟、索償及要求對政府作出彌償。

34. 對服務造成損壞

特別條款第(58)條

承批人須於所有時候，特別是在進行任何建築、保養、翻新或維修工程(以下簡稱「工程」)期間，採取或促使他人採取一切適當及充分的謹慎、技巧及預防措施、避免對該地段或綠色區域或其任何部份之上、上面、之下或毗鄰的任何政府擁有或其他現有排水渠、水道或渠道、總水管、道路、行人道、街道設施、污水管、明渠、喉管、電纜、電線、公用事業設施或任何其他工程或裝置(以下統稱「服務」)造成任何損壞。承批人須在進行任何工程之前進行或促使他人進行適當的勘測及必定要了解、確定服務的現況及水平，並提交處理任何可能被工程影響的任何服務的建議書給署長，供其全面審批和必須在取得署長對工程及上述建議書作出的書面批准後，才能進行該等工程並自費履行署長在審批時對服務作出的任何要求，包括承擔進行作出任何必要的改道、重鋪或修復的費用。承批人須自費維修、彌補及恢復原狀任何因工程對該地段或綠色區域或其任何部份或任何服務以任何方式引起的任何損壞、干擾或阻礙(除非署長另作選擇，明渠、污水管、雨水渠或總水管須由署長進行彌補，而承批人須要求向政府支付該等工程的費用)，以在各方面使署長滿意。如果承批人未能對該地段或綠色區域或其任何部份或任何服務進行該等必要的改道、重鋪、維修、彌補及恢復原狀的工程以至署長滿意，署長可進行其認為必要的上述改道、重鋪、維修、恢復原狀或彌補工程，而承批人須應要求向政府支付該等工程的費用。

35. 建造排水渠及渠道和接駁排水渠及污水管

特別條款第(59)條

- (a) 承批人應按署長視為需要自費以署長滿意的方式在該地段邊界範圍內或政府官地上建造和維修排水渠及渠道，以截流及引流所有落下或流進該地段的暴雨污水或雨水至最鄰近的河溪、集水井、渠道或政府雨水渠。倘此等暴雨污水或雨水造成任何損害、人身損傷、損失、滋擾或騷擾以致引起任何訴訟、索償及索求，承批人必須承擔全責並向政府及其官員作出彌償。
- (b) 接駁該地段任何排水渠及污水管至已鋪設和啟用之政府雨水渠及污水管的工程可由署長負責執行。署長毋須就由此引起的任何損失或損害向承批人承擔責任，而承批人接獲政府通知時須向政府支付此等接駁工程的費用。此外，承批人亦可自費以署長滿意的方式執行上述接駁工程。於該情況下，位於政府官地範圍內的上述接駁工程部份將由承批人自費維修，如政府發出通知，承批人須將此等工程部份移交政府，日後由政府自費維修，承批人並須在政府通知時向政府繳付上述接駁工程的技術審核費用。

36. 渠務專用範圍

特別條款第(60)條

- (a) 不能在批地文件所夾附的圖則上以粉紅色間黑交叉線、粉紅色間黑交叉線加黑點、粉紅色間黑交叉線加紅點、粉紅色間黑交叉線加紅點黑斜線顯示的範圍(上述有顏色範圍在下文統稱「渠務專用範圍」)之上、上方、之下、上面、下面或之內搭建或建築或安置任何建築物、構築物、地基或任何建築物或構築物的支撐物。不能在渠務專用範圍種植有穿透根部的樹木或灌木，除了：
- (i) 批地文件特別條款第(60)(f)(i)條提述的現有構築物或承托物包括現有排水管道及重置排水管道、批地文件特別條款第(61)(i)條提述的現有總水喉、於批地文件之日在渠務專用範圍之上、之下、上方、下方或之內已搭建、建造或安置的現有公廁及現有公共運輸交匯處；
- (ii) 新的公共運輸交匯處；
- (iii) 地面車輛引道；
- (iv) 地面公眾通道；
- (v) 專上學院停車處和公共停車處；
- (vi) 獲署長批准的其他構築物。
- (b) 即使批地文件特別條款第(60)(a)條有任何規定，經署長預先書面同意，可以在渠務專用範圍上面或以上可以搭建或建築建築物，但是在批地文件所夾附圖則上以粉紅色間黑交叉線和粉紅色間黑交叉線加黑點顯示該地段的範圍之地面向上延伸的淨高空域不少於5.1米，在批地文件所夾附圖則上以粉紅色間黑交叉線加紅點和粉紅色間黑交叉線加紅點黑斜線顯示該地段的範圍之地面向上延伸的淨高空域不少於8.0米。就批地文件特別條款第(60)條而言，署長就甚麼構成地面水平的決定是最終決定並對承批人有約束力。
- (c) 承批人或任何人士無權就任何法規或批地文件特別條款第(60)(a)和(b)條提述的權利與義務或使用渠務專用範圍的後果向政府要求補償。
- (d) 於批地文件約定的批租年期內，署長及其正式授權的官員、承辦商和他們的工人(以下統稱「經授權人等」)有權隨時，不論攜帶工具、設備、機器或駕車與否，可不受限制地通行、進出、往返及行經該地段，以便在渠務專用範圍鋪設、檢查、修理和維修署長規定或批准現時橫貫、經過渠務專用範圍或位於其下的排水渠、污水管、渠道、排水設施及所有其他服務設施(以下簡稱「公用服務設施」)。渠務專用範圍內概不可放置任何性質的物件或物料，以致阻礙通行或招致超額的公用服務設施附加費。如署長認為(其意見將為最終論並對承批人有約束力)渠務專用範圍內有任何物件或物料阻礙通行或招致超額的公用服務設施附加費，署長有權向承批人發出書面通知，要求承批人自費以署長全面滿意的方式拆卸及拆除此等物件或物料，並且恢復渠務專用範圍的原貌。

Summary of land grant

批地文件的摘要

- (e) 除必須還原其行使上述權利和權力時挖掘的任何坑槽外，政府及經授權人等概毋須因為或鑒於經授權人等行使批地文件特別條款第(60)(d)條所賦予權利或處理附帶於此等權利之事宜而不受限制地通行、進出、往返和鋪設、檢查、修理及維修公用服務設施而導致承批人招致或蒙受的任何損失、損害、滋擾或騷擾而承擔任何責任，承批人不得基於任何此等損失、損害、滋擾或騷擾向政府或經授權人等索償。
- (f) (i) 承批人須應渠務署署長要求自費將目前在渠務專用範圍內於批地文件所夾附圖則上以紅色線劃定的位置的排水管道改道至批地文件所夾附圖則上以綠色線劃定的新位置(「**改道工程**」)。當完成該改道工程後，渠務專用範圍將縮減到批地文件所夾附的圖則上以粉紅色間黑交叉線加黑點、粉紅色間黑交叉線加紅點、粉紅色間黑交叉線加紅點黑斜線顯示的較小範圍(「**新渠務專用範圍**」)。批地文件特別條款第(60)(a)至(e)條將適用於新渠務專用範圍。
 - (ii) 在展開改道工程之前，承批人必須取得渠務署署長的預先書面批准並採取一切必要的預防措施，確保改道工程不影響渠務專用範圍內的現有排水系統之運作。

37. 水務設施專用範圍

特別條款第(61)條

- (a) 未經水務署署長的預先書面同意，不能在批地文件所夾附圖則上以藍色虛線圈住並註明“**WWR**”的該地段的範圍(「**水務設施專用範圍**」)之上、上方、之下、上面、下面或之內搭建或建造或安置任何建築物或構築物或建築物或構築物的支撐物，除了於批地文件之日已經存在或准許在水務設施專用範圍之上、上方、之下、上面、下面或之內搭建的構築物。不能在水務設施專用範圍之上或之內放置或堆積任何材料或物件或停泊車輛(除車輛可以隨時駛走)。水務署署長就車輛能否馬上駛走的決定為最終決定並對承批人有約束力。
- (b) 即使批地文件特別條款第(61)(a)條規定，在受制於批地文件特別條款第(60)(a)和(60)(b)條下，可以在水務設施專用範圍之上或上面搭建或建造建築物，但是從地面向上伸展的淨高空域須不少於5米。署長就甚麼構成地面水平的決定是最終決定並對承批人有約束力。
- (c) 水務設施專用範圍內不得種植植物或放置任何性質的阻礙物，惟可在閘蓋周圍1.5米範圍內或任何消防栓出水掣1米內鋪草。
- (d) 未經水務署署長的預先書面同意，不可在水務設施專用範圍內種植任何樹木或灌木。
- (e) 如果承批人要求在水務設施專用範圍內鋪設的政府總水喉改道，其建議路徑必須提交給水務署署長批核和遷移政府總水喉的費用須由承批人承擔，該地段之上、上方、之下、上面、下面或之內鋪設新總水喉的部分亦須構成水務設施專用範圍之一部分。
- (f) 承批人須於批地文件約定的批租年期內，對承批人、他的僱工、工人及承辦商在該地段之上、上方、之下、上面、下面或之內進行的活動或造成任何損壞，導致需要對政府總水喉、閘門、閘門井、小室或其他水務工程構築物及設施和有關政府總水喉的類似設施進行維修與修復所產生的費用在要求時支付給政府，並對因此產生的任何索償、訴訟或要求彌償政府。

- (g) 現保留權利給政府、水務署署長、其官員、水務署署長指定其他政府部門的官員、水務署署長或其他指定政府部門或他們正式授權的承辦商或被許可以人聘請的承辦商、許可人、工人帶上或不帶工具、設備、機械、機器或車輛在任何時候自由及不受限制地出入來回及通過該地段或其中任何部分，旨在視察、鋪設、安裝、操作、保養、維修及翻新流經、穿過水務設施專用範圍或在其下的任何或一切現有政府總水喉、閘門、閘門井、小室或政府總水喉有關的其他水務工程構築物及設施。
 - (i) 承批人確認目前在水務設施專用範圍內有在政府總水喉、閘門、閘門井、小室或其他水務工程構築物及設施(統稱「**現有總水喉**」)、政府對現有總水喉的存在造成承批人或使其蒙受任何損害、滋擾或干擾毋須承擔任何責任，承批人須對現有總水喉的存在有關或直接或間接引致的一切責任、索償、費用、要求、訴訟或其他司法程序彌償政府並保證其被彌償。
 - (j) 未經渠務署署長的預先書面同意，不可拆除或遷移現有總水喉。渠務署署長可在作出批准時施加他認為合適的條件，

38. 後移範圍

特別條款第(62)條

- (a) 除批地文件特別條款第(60)條規定外，未經署長的預先書面同意，不能在本批地文件所夾附圖則上以粉紅色間黑斜線和粉紅色間黑交叉線加紅點黑斜線顯示該地段的地面之上、上方或上面搭建、建造或放置任何建築物或構築物或建築物或構築物的支撐物和儲存或放置任何物件或各種材料(統稱「**後移範圍**」)。
- (b) 即使批地文件特別條款第(62)(a)條規定，承批人可在後移範圍內搭建或允許他人搭建經批准園景設計總圖或城市規劃委員會批准的任何總規劃圖所顯示的園景及康樂設施、天篷、有蓋行人路、其他構築物和署長可書面批准的其他構築物或設施。
- (c) 經署長書面批准可按署長自行酌情決定的條款及條件更改後移範圍的佈局、位置、配置、長度及寬度，以配合城市規劃委員會已批准或將批准的總規劃圖。
- (d) 承批人須於批地文件約定的批租年期內保持後移範圍開放給公眾為了合法目的每日24小時自由及不受阻礙地使用並使署長滿意。
- (h) 承批人須於批地文件約定的批租年期內，自費管理與保養後移範圍和按批地文件特別條款第(62)(b)條在其上面已建或擬建的一切構築物及設施處於修繕良好的狀態並使署長滿意。
- (j) 就批地文件特別條款第(62)條而言，「承批人」一詞不包括財政司司長法團。

Summary of land grant

批地文件的摘要

39. 准許建造緩解噪音頂蓋伸入政府土地

特別條款第(64)條

- (a) 經署長預先書面同意（署長可自行酌情給予同意並施加他認為合適的條款及條件，包括署長可決定承批人支付任何地價），承批人可自費建造緩解噪音頂蓋從該地段的邊界伸入車公廟路旁邊的政府土地（「伸展頂蓋」），在一切方面使署長滿意。
- (b) 承批人須自費維護、管理、保養、維修及清潔伸展頂蓋或其中任何部分或承批人按批地文件特別條款第(64)(d)條提供的替代品處於修繕良好狀態，在一切方面使署長滿意。承批人須不時帶上或不帶工具、設備、機械、機器或車輛進入車公廟道旁邊的政府土地或署長可批准毗連政府土地的其他區域，旨在視察、建造、更改、維修、管理、保養、清潔、拆除及更換伸展頂蓋。
- (d) 倘若重建該地段或其中任何部分需要拆除伸展頂蓋或其中任何部分，經署長預先書面同意，承批人可自費建築與完成新的伸展頂蓋以替代已拆除的伸展頂蓋，在一切方面使署長滿意。署長可自行酌情給予同意並施加他認為合適的條款及條件。
- (f) 未經署長的預先書面同意，不可更改或增加伸展頂蓋或其中任何部分或增建部分。
- (g) 承批人須在任何時候採取必要的預防措施防止因為建造、更改、維修、管理、保養、清潔、拆除、更換或使用伸展頂蓋對政府土地或使用政府土地的任何人士或車輛造成任何損害或損傷。
- (h) 就批地文件特別條款第(64)條而言，「**承批人**」一詞不包括財政司司長法團

40. 保護鐵路

特別條款第(65)條

- (a) 在不影響批地文件特別條款第(33)條賦予政府的權利下，任何人士在大圍站使用此等條款賦予他的權利時，承批人須進行一切必要的促進工程促進或使該人士能行使該權利，該人士：
 - (i) 未經承批人的同意(該同意不能不合理地拒絕發出)不能作任何事情，以致可能不利地影響九廣鐵路的營運或安全，倘若造成損傷必須作出合理補償；
 - (ii) 盡量減少損壞並對一切損壞作出合理補償；及
 - (iii) 補償承批人進行使該人士能行使上述權利的任何工程所支出任何開支。
- (b) 承批人須進行一切必要的促進工程連同批地文件特別條款第(65)(a)條提述的人士之工程，該人士：
 - (i) 未經承批人的同意(該同意不能不合理地拒絕發出)不能作任何事情，以致可能不利地影響九廣鐵路的營運或安全，倘若因為該人士的要求造成損傷，該人士必須作出合理補償；
 - (ii) 確保該人士要求的任何設施工程盡量減少損壞並對一切損壞作出合理補償；及
 - (iii) 補償承批人進行使該人士能行使上述權利的任何工程所支出任何開支。

- (c) 就批地文件特別條款第(65)條而言，「**承批人**」一詞僅指進入與履行批地文件的人士和九廣鐵路(按批地文件特別條款第(29)(b)條定義)。

41. 不准兜售

特別條款第(66)條

承批人不得准許或容許任何小販在該地段、大圍站、現有行人天橋的支撐物、連接物及延伸物及有蓋行人天橋內進行兜售並須驅趕進行兜售的小販離開。承批人須在該地段一切入口旁邊的顯眼處張貼“不准在此兜售”。就此等條款而言，「小販」一詞具有《公共衛生及市政條例》、該條例下任何規例及任何修訂法例的定義，但是在批地文件特別條款第(66)條中，「在任何公眾地方」一詞須從該定義(a)段中刪除，而用「本地段、大圍站、現有行人天橋的支撐物、連接物及延伸物及有蓋行人天橋內」代替，惟按此等條款准許用作商業用途的任何部分除外。

42. 不准展示廣告

特別條款第(67)條

未經署長的預先書面同意，承批人不能在大圍站或其外部展示或准許或容許他人展示任何廣告標誌、圍板通告板或海報作戶外廣告用途。若取得上述同意也只能按署長可絕對酌情要求或描述的條件及條件進行。如果為了營運鐵路而在大圍站任何部分展示標誌、通告或海報，則毋須取得署長的預先書面同意。

43. 不准製作墳墓或骨灰龕

特別條款第(68)條

不能在該地段搭建或製作墳墓或骨灰龕，亦不能在其內或其上用泥壇、骨灰盒或其他形式埋葬或存放人類遺骸或動物遺骸。

備註：

欲悉詳情請參考「批地文件」。「批地文件」全文已備於售樓處，歡迎在開放時間免費閱覽，並可在支付必要的影印費用後索取影印副本。

Information on public facilities and public open spaces

公共設施及公眾休憩用地的資料

A. Any facilities that are required under the land grant to be constructed and provided for the Government, or for public use

1. Green Areas and Structures

(I) Provisions under the land grant:

Special Condition No.(5)(a)

The Grantee shall:

(i) on or before the 30th day of September 2022, or such other date or dates as may be approved by the Director, at his own expense, in such manner with such materials and to such standards, levels, alignment and design as the Director shall approve and in all respects to the satisfaction of the Director:

(I) lay and form those portions of future public roads shown coloured green on the plan annexed to the Land Grant ("**the Green Areas**"); and

(II) provide and construct such bridges, tunnels, over-passes, under-passes, culverts, viaducts, flyovers, pavements, roads or such other structures as the Director in his sole discretion may require ("**the Structures**")

so that building, vehicular, pedestrian and cyclist traffic may be carried on the Green Areas;

(ii) on or before the 30th day of September 2022, or such other date or dates as may be approved by the Director, at his own expense and to the satisfaction of the Director, surface, kerb and channel the Green Areas and provide the same with such gullies, sewers, drains, fire hydrants with pipes connected to water mains, services street lights, traffic signs, street furniture, road markings and plant as the Director may require; and

(iii) maintain at his own expense the Green Areas together with the Structures and all structures, surfaces, gullies, sewers, drains, fire hydrants, services, street lights, traffic signs, street furniture, road markings and plant constructed, installed and provided thereon or therein to the satisfaction of the Director until such time as possession of the Green Areas has been re-delivered to the Government by the Grantee in accordance with Special Condition No. (6) of the Land Grant.

Special Condition No. (6)

For the purpose only of carrying out the necessary works specified in Special Condition No. (5) of the Land Grant, the Grantee shall on the date of the Land Grant be granted possession of the Green Areas. The Green Areas or any part or parts thereof shall be re-delivered to the Government on demand and in any event the Green Areas shall be deemed to have been re-delivered to the Government by the Grantee on the date of a letter from the Director indicating that these Conditions have been complied with to his satisfaction. The Grantee shall at all reasonable times while he is in possession of the Green Areas or any part or parts thereof allow free access over and along the Green Areas or such part or parts thereof for all Government and public vehicular, pedestrian and cyclist traffic and shall ensure that such access shall not be interfered with or obstructed by the carrying out of the works whether under Special Condition No. (5) of the Land Grant or otherwise.

Special Condition No. (7)

The Grantee shall not without the prior written consent of the Director use the Green Areas for the purpose of storage or for the erection of any temporary structure or for any purposes other than the carrying out of the works specified in Special Condition No. (5) of the Land Grant.

Special Condition No. (8)(a)

The Grantee shall at all reasonable times while he is in possession of the Green Areas or any part or parts thereof :

(i) permit the Government, the Director and his officers, contractors and agents and any persons authorized by the Director, the right of free and unrestricted ingress, egress and regress to, from and through the lot and the Green Areas or any part or parts thereof for the purpose of inspecting, checking and supervising any works to be carried out in compliance with Special Condition No.(5)(a) of the Land Grant and the carrying out, inspecting, checking and supervising of the works under Special Condition No.(5)(b) of the Land Grant and any other works which the Director may consider necessary in the Green Areas or any part or parts thereof;

(ii) permit the Government and the relevant public utility companies authorized by the Government the right of free and unrestricted ingress, egress and regress to, from and through the lot and the Green Areas or any part or parts thereof as the Government or the relevant public utility companies may require for the purpose of any works to be carried out in, upon or under the Green Areas or any part or parts thereof or any adjoining land including but not limited to the laying and subsequent maintenance of all pipes, wire, conduits, cable-ducts and other conducting media and ancillary equipment necessary for the provision of telephone, electricity, gas (if any) and other services intended to serve the lot or any adjoining or neighbouring land or premises, and the Grantee shall co-operate fully with the Government and also with the relevant public utility companies duly authorized by the Government on all matters relating to any of the aforesaid works to be carried out within the Green Areas or any part or parts thereof; and

(iii) permit the officers of the Water Authority and such other persons as may be authorized by them the right of free and unrestricted ingress, egress and regress to, from and through the lot and the Green Areas or any part or parts thereof as the officers of the Water Authority or such authorized persons may require for the purpose of carrying out any works in relation to the operation, maintenance, repairing, replacement and alteration of any other waterworks installations within the Green Areas or any part or parts thereof.

Information on public facilities and public open spaces 公共設施及公眾休憩用地的資料

(II) Provisions under the principal deed of mutual covenant :

Section B – Definitions

“Green Areas” means those portions of future public roads shown coloured green on the plan annexed to the Government Grant as referred to under Special Condition No.(5)(a)(i)(I) of the Government Grant;

“Structures” means the Structures as defined in Special Condition No.(5)(a)(i)(II) of the Government Grant;

“Other Structures and Facilities” means all structures, surfaces, gullies, sewers, drains, fire hydrants, services, street lights, traffic signs, street furniture, road markings and plant constructed, installed and provided on or in the Green Areas to the satisfaction of the Director in accordance with Special Condition No.(5)(a)(iii) of the Government Grant.

Section E – Clause 18

18. (a) The Owners (excluding the Owner of the Tai Wai Station and The Financial Secretary Incorporated (“the FSI”) as the Owner of the Government Accommodation) shall at their own expense maintain the Green Areas together with the Structures and the Other Structures and Facilities to the satisfaction of the Director in accordance with Special Condition No.(5)(a)(iii) of the Government Grant until such time as possession of the Green Areas have been re-delivered to the Government in accordance with Special Condition No.(6) of the Government Grant.

(b) The Owners shall at all reasonable times while the Owners are in possession of the Green Areas or any part or parts thereof allow free access over and along the Green Areas or such part or parts thereof for all Government and public vehicular and pedestrian and cyclist traffic and shall ensure that such access shall not be interfered with or obstructed by the carrying out of the works whether under Special Condition No.(5) of the Government Grant or otherwise.

(c) The Owners shall at all reasonable times while they are in possession of the Green Areas or any part or parts thereof permit the Director, his officers, contractors, agents and any other persons authorized by him, the Government and the relevant public utility companies authorised by the Government, the officers of the Water Authority and such other persons as may be authorised by the Water Authority, the right of free and unrestricted ingress, egress and regress to, from and through the Land and the Green Areas or part or parts thereof for the purpose of carrying out, inspecting and supervising of the works as referred to under Special Condition No.(8)(a) of the Government Grant.

Section I – Clause 1(b)(xvi)

Without in any way limiting the generality of the foregoing, the Manager shall have the following powers and duties, namely

...

To permit the Director, his officers, contractors and agents and any other persons authorized by him, the Government and public utilities company authorised by the Government and the officers of the Water Authority and such other persons as may be authorized by the Water Authority to enter into the Land and the Green Areas and provide access for the ingress, egress and regress to, from and through the Land and the Green Areas as may be required for the purpose of carrying out, inspecting, checking and supervising any works as referred to under Special Condition No.8(a) of the Government Grant.

Section J – Clause 2(a)(i)

There shall be established and maintained by the Manager one Special Fund which shall be comprised of the following books of separate accounts:

...

An estate account of the Special Fund for the purposes of meeting the cost of major works of a capital nature or of a kind not expected to be incurred annually in respect of the Existing Public Toilet Items, the Post Secondary College Items (“PSC Items”) and the PTI Items which are the obligations of the Owners (save and except FSI as the Owner of the Government Accommodation) under Clause 10 of Section E of the Principal Deed of Mutual Covenant, the Slope and Retaining Structures, the prestressed ground anchors (if any), the Green Areas, the Structures and the Other Structures and Facilities, the Estate Common Areas and/or the Estate Common Services and Facilities which includes, but is not limited to, expenses for the renovation, improvement and repair of the Existing Public Toilet Items, the PSC Items and the PTI Items, the Slope and Retaining Structures, the prestressed ground anchors (if any), the Green Areas, the Structures and the Other Structures and Facilities, the Estate Common Areas and/or the Estate Common Services and Facilities, the purchase, setting up, replacement, improvement and addition of installations, systems, equipment, tools, plant and machines for the Estate Common Areas and/or the Estate Common Services and Facilities and the costs of the relevant investigation works and professional services.

Section J – Clause 4(i)(i)

(i) The Manager shall prepare the following budgets :-

(i) an Estate Management Budget which shall show the estimated expenditure for the management and maintenance of the Existing Public Toilet Items, the PSC Items and the PTI Items which are the obligations of the Owners (save and except FSI as the Owner of the Government Accommodation) under Clause 10 of Section E of the Principal Deed of Mutual Covenant, the Slope and Retaining Structures, the prestressed ground anchors (if any), the Green Areas, the Structures and the Other Structures and Facilities, the Estate Common Areas and the Estate Common Services and Facilities including the contribution to the estate account of the Special Fund and an appropriate portion of the Manager's Remuneration but excluding expenditure attributable to the Residential Development, the Commercial Development or the Residential Parking Spaces.

Information on public facilities and public open spaces 公共設施及公眾休憩用地的資料

2. Existing Public Toilet

(I) Provisions under the land grant:

Special Condition No.(16)

- (a) The Grantee acknowledges that there is a public toilet with a net operational floor area of not less than 71.3 square metres on the ground level of the lot (which accommodation (including lighting fixtures, ventilation plant, extract ductworks and road or floor surfaces but excluding such lifts, escalators, stairways, plant, equipment and other facilities not serving exclusively thereto as may be permitted by the Director in accordance with these Conditions, walls, columns, beams, ceilings, roof slabs, carriageway or floor slabs and any other structural elements) together with any other areas, facilities, services and installations exclusive thereto as the Director may in his absolute discretion determine (whose determination shall be conclusive and binding on the Grantee) is hereinafter referred to as "**the Existing Public Toilet**"). The Government will accept no responsibility or liability for any loss, damage, nuisance or disturbance whatsoever caused to or suffered by the Grantee by reason of the presence, operation and use of the Existing Public Toilet.
- (c) The Government hereby reserves the right to alter or vary in its absolute discretion at any time the use of the Existing Public Toilet or any part thereof.
- (e) (i) The, Grantee shall at all times throughout the term agreed to be granted by the Land Grant permit all members of the public for all lawful purposes freely and without payment of any nature whatsoever to enter into, upon and through such part or parts of the lot and in, under, through, on or over any buildings, structures and erection thereon designated by the Grantee to the satisfaction of the Director of Food and Environmental Hygiene for the purpose of unobstructed access to and from the Existing Public Toilet and the adjacent public road.
- (g) Upon possession of the lot being given to and taken by the Grantee in accordance with Special Condition No. (3) of the Land Grant, possession of the Existing Public Toilet shall be deemed to be delivered by the Grantee to the Government for its exclusive use, occupation and operation.

(II) Provisions under the principal deed of mutual covenant:

Section B – Definitions

"Existing Public Toilet" means the existing public toilet on the ground level of Sha Tin Town Lot No.520 ("the Land") (including lighting fixtures, ventilation plant, extract ductworks and road or floor surfaces but excluding such lifts, escalators, stairways, plant, equipment and other facilities not serving exclusively thereto as may be permitted by the Director in accordance with the Government Grant, walls, columns, beams, ceilings, roof slabs, carriageway or floor slabs and any other structural elements) together with any other areas, facilities, services and installations exclusive thereto as the Director may in his absolute discretion determine, referred to in Special Condition No.(16)(a) of the Government Grant and for the purpose of identification only as shown (where possible and capable of being shown) coloured pink on the Ground Floor Plan annexed to the Principal Deed of Mutual Covenant;

"Government Accommodation" means the Existing Public Toilet, the New PTI and the PSC, which for the avoidance of doubt, shall exclude the external finishes and external facade of the PSC and the structure of all walls, columns, beams, ceilings, roof slabs, carriageway or floor slabs and any other structural elements of, in, around, within, above and below the PSC.

3. Existing PTI

(I) Provisions under the land grant:

Special Condition No. (17)

- (a) The Grantee acknowledges that there is a public transport interchange on the ground level of the lot (which accommodation (including lighting fixtures, ventilation plant, extract ductworks and road or floor surfaces but excluding such lifts, escalators, stairways, plant, equipment and other facilities not serving exclusively thereto as may be permitted by the Director in accordance with these Conditions, walls, columns, beams, ceilings, roof slabs, carriageway or floor slabs and any other structural elements) together with any other areas, facilities, services and installations exclusive thereto as the Director may in his absolute discretion determine (whose determination shall be conclusive and binding on the Grantee) is hereinafter referred to as "**the Existing PTI**"). The Government will accept no responsibility or liability for any loss, damage, nuisance or disturbance whatsoever caused to or suffered by the Grantee by reason of the presence, operation and use of the Existing PTI and the Grantee hereby indemnifies and shall keep indemnified the Government from and against all liabilities, claims, costs, demands, actions or other proceedings whatsoever arising whether directly or indirectly out of or in connection with anything done or omitted to be done by the Grantee, his servants, workmen and contractors in the Existing PTI.
- (b) Upon possession of the lot being given to and taken by the Grantee in accordance with Special Condition No. (3) of the Land Grant, possession of the Existing PTI shall be deemed to be delivered by the Grantee to the Government for its exclusive use, occupation and operation, but without prejudice to any agreement made between the Government and the Grantee on the maintenance of the Existing PTI, until the re-delivery of possession of the Existing PTI to the Grantee in accordance with sub-clause (g) of Special Condition No. (17) of the Land Grant.

Information on public facilities and public open spaces

公共設施及公眾休憩用地的資料

- (c) The Grantee shall permit the public to use the Existing PTI and shall not interfere with the normal operation of the Existing PTI. No building works which may affect the normal operation of the Existing PTI shall be carried out except with the prior written approval of the Commissioner for Transport.
 - (e) The Government shall have the absolute discretion at any time to determine on the public use of the Existing PTI or any part thereof during which the Existing PTI is in the possession of the Government.
 - (f) (i) The Grantee shall allow unrestricted and free access to and from the Existing PTI through the lot or any part thereof for all Government and public vehicular and pedestrian traffic and the Government shall have the absolute right in exercising its power under the Road Traffic Ordinance and the Public Bus Services Ordinance, any regulations made thereunder and any amending legislation.
 - (g) The possession of the Existing PTI shall be deemed to be redelivered to the Grantee immediately prior to the delivery, upon demand by the Director, of vacant possession of the New PTI (as defined in Special Condition No. (18)(a)(i) of the Land Grant) to the Government in accordance with Special Condition No. (18)(1) of the Land Grant or the assignment of the New PTI to F.S.I. pursuant to Special Condition No. (18)(i) of the Land Grant, whichever is the earlier.
- (II) Provisions under the principal deed of mutual covenant:

Section B – Definition

"Existing PTI" means the public transport interchange then existing on the ground level of the Land (including lighting fixtures, ventilation plant, extract ductworks and road or floor surfaces but excluding such lifts, escalators, stairways, plant, equipment and other facilities not serving exclusively thereto as may be permitted by the Director in accordance with the Government Grant, walls, columns, beams, ceilings, roof slabs, carriageway or floor slabs and any other structural elements) together with any other areas, facilities, services and installations exclusive thereto as the Director may in his absolute discretion determine, referred to in Special Condition No.(17)(a) of the Government Grant.

4. New PTI

- (I) Provisions under the land grant:

Special Condition No. (18)

- (a) (i) The Grantee shall at his own expense and in all respects to the satisfaction of the Director design, erect, construct and provide (including conducting all necessary works and modification works to the Existing PTI and any other works which the Commissioner for Transport may consider necessary) in a good workmanlike manner and in accordance with these Conditions and the plans approved under sub-clause (d) of Special Condition No. (18) of the Land Grant one public transport interchange located or to be located at the ground level of the lot comprising a bus terminus with seven sawtooth bus bays, one parallel bus bay and six parallel bus stacking spaces, four parallel green minibus bays, one parallel general loading and unloading bay, two public loading and unloading bays and one taxi lay-by or such other numbers or facilities as may be required or approved by the Commissioner for Transport and an area with a net operational floor area of not less than 45 square metres reserved for ancillary facilities for bus operator, with access connecting with public roads and provision of ancillary facilities, to be completed and made fit for occupation and operation on or before 30th day of September, 2022 or such other later date as may be determined by the Director (whose determination shall be final and binding on the Grantee) (which accommodation (including lighting fixtures, ventilation plant, extract ductworks and road or floor surfaces but excluding such lifts, escalators, stairways, plant, equipment and other facilities not serving exclusively thereto as may be permitted by the Director in accordance with these Conditions, walls, columns, beams, ceilings, roof slabs, carriageway or floor slabs and any other structural elements) together with any other areas, facilities, services and installations exclusive thereto as the Director may in his absolute discretion determine (whose determination shall be conclusive and binding on the Grantee) is hereinafter referred to as "the New PTI").
- (b) The Government hereby reserves the right to alter or vary in its absolute discretion at any time the use of the New PTI or any part thereof.

Information on public facilities and public open spaces 公共設施及公眾休憩用地的資料

(III) Provisions under the principal deed of mutual covenant:

Section B – Definitions

“New PTI” means the public transport interchange located or to be located at the ground level of the Land and constructed or to be constructed in accordance with Special Condition No.(18)(a)(i) of the Government Grant comprising a bus terminus with seven sawtooth bus bays, one parallel bus bay and six parallel bus stacking spaces, four parallel green minibus bays, one parallel general loading and unloading bay, two public loading and unloading bays and one taxi lay-by or such other numbers or facilities as may be required or approved by the Commissioner for Transport and an area with a net operational floor area of not less than 45 square metres reserved for ancillary facilities for bus operator, with access connecting with public roads and provision of ancillary facilities (including lighting fixtures, ventilation plant, extract ductworks and road or floor surfaces but excluding such lifts, escalators, stairways, plant, equipment and other facilities not serving exclusively thereto as may be permitted by the Director in accordance with the Government Grant, walls, columns, beams, ceilings, roof slabs, carriageway or floor slabs and any other structural elements) together with any other areas, facilities, services and installations exclusive thereto as the Director may in his absolute discretion determine and for the purpose of identification only as shown (where possible and capable of being shown) coloured indigo and indigo hatched black on the floor plans annexed to the Principal Deed of Mutual Covenant;

“Government Accommodation” means the Existing Public Toilet, the New PTI and the PSC, which for the avoidance of doubt, shall exclude the external finishes and external facade of the PSC and the structure of all walls, columns, beams, ceilings, roof slabs, carriageway or floor slabs and any other structural elements of, in, around, within, above and below the PSC.

5. Bicycle Park and Cycle Track

(I) Provisions under the land grant:

Special Condition No. (20)

- (a) The Grantee shall on or before 30th day of September, 2022 or within such time limit as may be specified and subject to such conditions as may be approved by the Director at his own expense and in all respects to the satisfaction of the Director erect and construct in a good workmanlike manner and thereafter maintain and manage a bicycle park which shall comprise 330 spaces or such other number as may be approved by the Director and shall be located in close proximity to the New PTI or at such other location as may be determined by the Director for the parking of bicycles of the public (“**the Bicycle Park**”). The Grantee shall submit or cause to be submitted to the Commissioner for Transport detailed design proposal for his written approval prior to commencement of works.
- (c) The Grantee shall throughout the term agreed to be granted by the Land Grant keep the Bicycle Park open for use by the public 24 hours a day except for the period during which the Bicycle Park or any part or parts thereof shall have to be closed temporarily for the purpose of carrying out maintenance works.

Special Condition No. (21)

- (a) The Grantee shall on or before 30th day of September, 2022 or within such time limit as may be specified and subject to such conditions as may be approved by the Director at his own expense and in all respects to the satisfaction of the Director provide and thereafter maintain and manage a cycle track with a clear width of not less than 3.5 metres (“**the Cycle Track**”) so as to link up the Bicycle Park and the adjacent cycle tracks and to ensure continuity of the cycle track network of the Sha Tin New Town.
- (e) The Grantee shall throughout the term agreed to be granted by the Land Grant keep the Cycle Track open 24 hours a day free of charge for the passing and repassing of cyclists (whether riding on the cycles or not) without any interruption.

(II) Provisions under the principal deed of mutual covenant:

Section B – Definitions

“Bicycle Park” means the bicycle park constructed or to be constructed in all respects to the satisfaction of the Director and thereafter maintained and managed in accordance with Special Condition No.(20)(a) of the Government Grant for the parking of bicycles by the public forming part of the Commercial Development;

“Cycle Track” means the cycle track provided or to be provided in all respects to the satisfaction of the Director and thereafter maintained and managed in accordance with Special Condition No.(21) of the Government Grant forming part of the Commercial Development so as to link up the Bicycle Park and the adjacent cycle tracks and to ensure continuity of the cycle track network of the Sha Tin New Town;

Information on public facilities and public open spaces

公共設施及公眾休憩用地的資料

"Commercial Development" means and includes those parts of the Estate constructed or to be constructed in accordance with the Approved Plans for commercial or retail use and including the external walls of the said parts of the Estate, the external walls of the Estate from the floor slab level of 4th Floor to the ceiling level of 6th Floor (whether or not the parts of Estate enclosed by such external walls form parts of the Commercial Development), (excluding those external walls forming parts of the PSC Items) the spaces provided pursuant to Special Condition No.(43)(b) of the Government Grant for parking of motor vehicles and motor cycles belonging to the occupiers of the Commercial Development and their bona-fide guests, visitors or invitees (including the B3 Commercial Car Parking Spaces), the loading and unloading spaces of goods vehicles provided pursuant to Special Condition No.(44)(a)(ii) of the Government Grant and designated for use by the Commercial Development, the associated driveway and circulation areas, staircases, (in the event that the said parts of the Estate is situated immediately above the Tai Wai Station) all the slabs of the said parts of the Estate above the upper boundary of the Tai Wai Station including all the slabs and finishes above the water-proofing membrane and system and associated protection immediately above, and all utilities, services, trenches, pits and facilities which serve the Commercial Development or any part thereof, as well as all the external finishes of the Commercial Development, part of the 24-hour Walkway, parts of the Pedestrian Link, all those parts of the Greenery Areas which serve the Commercial Development as a whole (which shall be designated as part of the Commercial Common Areas in the Sub-Deed of Mutual Covenant of the Commercial Development), the parapet wall of the podium, the Bicycle Park, the Cycle Track, the Covered Footbridges (whether within or outside the boundary of the Land) and the Existing Footbridge Supports, Connections and Extensions, but excluding those parts forming parts of the Residential Development, the Residential Car Park, the Government Accommodation, the Estate Common Areas, the Residential Common Areas, the Residential Car Park Common Areas and the B3 Commercial Car Park Common Areas, and for the purpose of identification only as shown (where possible and capable of being shown) coloured orange and orange hatched black on the floor plans annexed to the Principal Deed of Mutual Covenant.

Second Schedule, Part II – Clause 4

- (e) The public shall throughout the term of the Government Grant have the right to use the Bicycle Park 24 hours a day except for the period during which the Bicycle Park or any part or parts thereof shall have to be closed temporarily for the purpose of carrying out maintenance works in accordance with Special Condition No.(20)(c) of the Government Grant.
- (f) The Cycle Track shall throughout the term of the Government Grant be kept open 24 hours a day free of charge for the passing or repassing of cyclists (whether riding on the cycles or not) without any interruption in accordance with Special Condition No.(21)(e) of the Government Grant.

6. Post-Secondary College (PSC), Parking Spaces for PSC and PSC Lay-Bys

- (l) Provisions under the land grant:

Special Condition No.(22)

- (a) (i) The Grantee shall at his own expense and in all respects to the satisfaction of the Secretary for Education design, erect, construct and provide within the lot in a good workmanlike manner and in accordance with these Conditions, the plans approved under sub-clause (c) of Special Condition No. (22) of the Land Grant and the specifications to be agreed upon by the Secretary for Education and the Grantee ("**the Specifications**"), one post secondary college with a total gross floor area of 15,000 square metres together with eight motor vehicles parking spaces and five motor cycle parking spaces as stipulated respectively in Special Condition Nos. (43)(c) and (43)(e)(i)(III) of the Land Grant (collectively, "**the PSC**").
- (ii) The Grantee shall complete the structural shell and the external façade of the PSC together with eight motor vehicles parking spaces and five motor cycle parking spaces on or before 31st day of March, 2020 or such later date as may be agreed by the Secretary for Education and the Grantee.
- (iii) Notwithstanding sub-clause (a)(i) of Special Condition No. (22) of the Land Grant, if the Grantee shall fail to agree with the Secretary for Education on the Specifications within 36 calendar months from the date of the Land Grant, the Grantee shall forthwith at his own expense and in all respects to the satisfaction of the Secretary for Education, on or before the time limit specified in sub-clause (a)(ii) of Special Condition No. (22) of the Land Grant, construct and provide the PSC within the lot in a good workmanlike manner and in accordance with the design and layout (including any subsequent amendments) approved or to be approved by the Secretary for Education.
- (iv) The Grantee shall at his own expense maintain and manage the PSC and everything thereon, therein or thereunder in good condition and to the satisfaction of the Director until such time as possession of the PSC has been delivered to the Government in accordance with sub-clause (m) of Special Condition No. (22) of the Land Grant or the PSC has been assigned to the F.S.I. pursuant to sub-clause (h) of Special Condition No. (22) of the Land Grant, whichever is the earlier.

- (b) The Government hereby reserves the right to alter or vary in its absolute discretion at any time the use of the PSC or any part thereof.

Special Condition No.(43)

- (c) Eight spaces shall be provided within the lot to the satisfaction of the Director for the parking of motor vehicles licensed under the Road Traffic Ordinance, any regulations made thereunder and any amending legislation, and belonging to the occupiers of the PSC and their bona fide guests, visitors or invitees and in particular the said spaces shall not be used for the storage, display or exhibiting of motor vehicles for sale or otherwise or for the provision of car cleaning and beauty services.

Information on public facilities and public open spaces 公共設施及公眾休憩用地的資料

Special Condition No. (49)

- (a) The Grantee shall on or before 30th day of September, 2022 or within such time limit as may be specified and subject to such conditions as may be approved by the Director at his own expense and in all respects to the satisfaction of the Director provide and thereafter manage and maintain at the ground level of the lot (the decision of the Director as to what constitutes the ground level shall be final and binding on the Grantee) one lay-by measuring 3.5 metres in width and 11.0 metres in length with a minimum headroom of 4.7 metres and not less than one lay-by measuring 2.5 metres in width and 40 metres in aggregate length with a minimum headroom of 2.4 metres for the picking up and setting down of passengers from motor vehicles (including taxis) (collectively, "**the PSC Lay-Bys**") in connection with the PSC.
- (e) The PSC Lay-Bys provided within the lot in accordance with sub-clause (a) of Special Condition No. (49) of the Land Grant shall be designated as and form part of the Common Areas.
- (f) The Grantee shall throughout the term agreed to be granted by the Land Grant keep the PSC Lay-Bys open for use by the occupiers of the PSC and their bona fide guests, visitors or invitees 24 hours a day free of charge without any interruption to the satisfaction of the Director.

(II) Provisions under the principal deed of mutual covenant:

Section B – Definitions

"Estate Common Areas" means those parts of the Estate which are intended for use by Owners of the Estate as a whole and not for the sole benefit of any Owner or group of Owners of the Estate including, but not limited to all those parts of the Greenery Areas which serve the Estate as a whole, all the slabs of the said parts of the Estate above the upper boundary of the Tai Wai Station including all the slabs above the water-proofing membrane and system and associated protection immediately above, all utilities, services, trenches, pits and facilities which serve the Estate, as well as all the finishes of the Estate, parts of the Setting-back Area, part of the 24-hour Walkway, parts of the Pedestrian Link, the Drainage Reserve or the New Drainage Reserve (as the case may be), the Waterworks Reserve, driveways, lifts, run in and out, the Public Lay-By, the PSC Lay-Bys, the Existing Public Toilet Items, the PSC Items, the PTI Items, cavity walls and diaphragm walls of the Basement Level 4 to the Basement Level 1, external walls, finishes and architectural features below the ceiling of 3rd Floor (excluding those parts of external walls forming parts of the Commercial Development and the finishes and architectural features thereof and thereat), external walls of the drum ramp above the ceiling level of 6th Floor up to the roof level, ramps, lift shafts, shuttle lifts, footpaths, staircases, landings, corridors and passages; pump rooms, transformer room, main switch room, electricity rooms, fire services control room, master meter cabinet and water meter room, fuel tank rooms, street fire hydrant and sprinkler and fire services pump room, fan rooms, sprinkler control valve room, pipe ducts, emergency generator rooms, air duct shaft, refuse storage and material recovery chamber; refuse collection point and spaces for the parking, loading and unloading of refuse collection vehicles provided pursuant to Special Condition No.(52)(b)(i) of the Government Grant; parapet walls, structural walls and columns, the foundations and other structural elements of the buildings erected on the Estate; management office, security room, guard rooms, caretaker's quarters, office for Owners Committee and/or Owners Corporation, stores, lavatories and any other space on or in the Estate used for office of caretaker(s) or other accommodation of the Owners Committee or the Owners Corporation and all other communal areas within the Estate not used for the sole benefit of any Owner or group of Owners of the Estate (but excluding all parts of the Commercial Development, the Residential Common Areas, the Residential Car Park Common Areas, the B3 Commercial Car Park Common Areas and those areas forming parts of other common areas as designated or to be designated in the Sub-Deed of Mutual Covenant or Deed Poll to be executed by the First Owner pursuant to the Principal Deed of Mutual Covenant). The Estate Common Areas in Phase 1 and Phase 2 are for the purpose of identification only as shown (where possible and capable of being shown) coloured green, green hatched black and green cross-hatched black on the plans annexed to the Principal Deed of Mutual Covenant and as shown (where possible and capable of being shown) coloured green, green hatched black and green cross-hatched black (for those parts within Phase 1) and coloured green dash hatched red (for those parts within Phase 2) on the Common Areas demarcation plans annexed to the Principal Deed of Mutual Covenant. The Estate Common Areas in other Phase(s) shall be identified on plans to be annexed to any Sub-Deed of Mutual Covenant or Deed Poll to be executed in respect of such other Phases.

Information on public facilities and public open spaces

公共設施及公眾休憩用地的資料

"Government Accommodation" means the Existing Public Toilet, the New PTI and the PSC, which for the avoidance of doubt, shall exclude the external finishes and external facade of the PSC and the structure of all walls, columns, beams, ceilings, roof slabs, carriageway or floor slabs and any other structural elements of, in, around, within, above and below the PSC.

"PSC" means the post secondary college with PSC Parking Spaces constructed or to be constructed in all respects to the satisfaction of the Secretary for Education in accordance with Special Condition No.22(a) of the Government Grant and for the purpose of identification only as shown (where possible and capable of being shown) coloured violet on the floor plans annexed to the Principal Deed of Mutual Covenant.

"PSC Lay-Bys" means the lay-bys provided or to be provided at the ground level of the Land in all respects to the satisfaction of the Director for the picking up and setting down of passengers from motor vehicles (including taxis) in connection with the PSC in accordance with Special Condition No.(49)(a) of the Government Grant forming part of the Estate Common Areas and for the purpose of identification only as shown (where possible and capable of being shown) coloured green cross-hatched black on the Ground Floor Plan annexed to the Principal Deed of Mutual Covenant.

"PSC Parking Spaces" means eight motor vehicle parking spaces and five motor cycle parking spaces constructed or to be constructed in all respects to the satisfaction of the Secretary for Education in accordance with Special Condition No.22(a) of the Government Grant forming part of the PSC.

Second Schedule, Part II – Clause 4(g)

The occupiers of the PSC and their bona fide guests visitors or invitees shall throughout the term of the Government Grant has the right to use the PSC Lay-Bys 24 hours a day free of charge without any interruption in accordance with Special Condition No.(49)(f) of the Government Grant.

7. Covered Footbridges, Existing Footbridge and Existing Footbridge Supports, Connections and Extensions

(I) Provisions under the land grant:

Special Condition No.(35)

- (a) The Grantee shall on or before 30th day of September 2022 or within such time limit as may be specified and subject to such conditions as may be approved by the Director at the Grantee's own expense and in all respects to the satisfaction of the Director:
- (i) erect, construct and provide two single-storey covered footbridges together with all supports and connections (including any supports and connections which the Director in his absolute discretion considers necessary for any future extension to the covered footbridges) as shall be required or approved by the Director (collectively, "**the Covered Footbridges**") in the approximate positions shown and marked "**PROPOSED FB 1**" and "**PROPOSED FB 2**" on the plan annexed to the Land Grant so that pedestrian access can be gained over the Covered Footbridges to and from the Pedestrian Link (as defined in Special Condition No. (36)(a) of the Land Grant). The Covered Footbridges shall be constructed with such materials and to such standards, levels, alignment, disposition and designs as shall be required and approved by the Director including but not limited to the provision and construction of such supports, ramps, associated staircases and landings, escalators, lifts, ramps or lifts for disabled persons and such internal and external fittings and fixtures and such lighting fittings as the Director in his sole discretion may require. Each of the Covered Footbridges shall have a clear internal width of 6.0 metres or such other width as may be approved by the Commissioner for Transport and a minimum clear internal headroom of 2.6 metres;
- (ii) modify the existing footbridge which is shown and marked as "**EXISTING FB**" on the plan annexed to the Land Grant together with all supports and connections (including any supports and connections which the Director in his absolute discretion considers necessary for any future extension to the existing footbridge) as shall be required or approved by the Director (collectively, "**the Existing Footbridge**") and provide and construct such supports, connections and extensions to the Existing Footbridge in the building or buildings to be erected on the lot (collectively, "**the Existing Footbridge Supports, Connections and Extensions**") so that pedestrian and cyclist access can be gained over the Existing Footbridge to and from the Pedestrian Link (as defined in Special Condition No.(36)(a) of the Land Grant). The modification and extension of the Existing Footbridge shall include provision of a cycle track of 2.8 metres in width or any other width as may be determined by the Commissioner for Transport. The Existing Footbridge Supports, Connections and Extensions shall be constructed with such materials and to such specifications, standards, levels, alignment, disposition and designs and at such points as shall be required and approved by the Director including but not limited to the provision and construction of such supports, ramps, associated staircases and landings, escalators, lifts, ramp(s) or lift(s) for disabled persons and such internal and external fittings and fixtures and such lighting fittings as the Director in his sole discretion may require.

Information on public facilities and public open spaces

公共設施及公眾休憩用地的資料

- (c) Notwithstanding anything to the contrary contained in these Conditions, throughout the term agreed to be granted by the Land Grant the Grantee shall at his own expense repair, manage and maintain the Covered Footbridges and the Existing Footbridge Supports, Connections and Extensions and any replacement or replacements thereof which may be constructed by the Grantee in accordance with sub-clause (g) of Special Condition No. (35) of the Land Grant in a clean, tidy and good and substantial repair and condition and in all respects to the satisfaction of the Director.
- (e) (i) The Covered Footbridges and the Existing Footbridge Supports, Connections and Extensions shall not be used for any purpose other than for the passage of all members of the public on foot or by wheelchair or bicycle.
- (ii) The Grantee shall not use or permit or suffer to be used any part of the Covered Footbridges and the Existing Footbridge Supports, Connections and Extensions either externally or internally for advertising or for the display of any signs, notices or posters whatsoever unless otherwise approved or required by the Director.
- (iii) The Grantee shall not do or permit or suffer to be done in the Covered Footbridges and the Existing Footbridge Supports, Connections and Extensions anything that may be or become a nuisance or annoyance or that may cause inconvenience or damage to any person or vehicle passing under the Covered Footbridges and the Existing Footbridge Supports, Connections and Extensions or to any owner or occupier of any adjacent or neighbouring lot or lots or premises.
- (iv) The Grantee shall throughout the period during which the Covered Footbridges are in existence permit all members of the public for all lawful purposes 24 hours a day freely and without payment of any nature whatsoever without any interruption to pass and repass on foot or by wheelchair or bicycle along, to, from, through, over, up and down the Covered Footbridges.
- (v) The Grantee shall throughout the period during which the Existing Footbridge Supports, Connections and Extensions are in existence permit all members of the public for all lawful purposes 24 hours a day freely and without payment of any nature whatsoever without any interruption to pass and repass on foot or by wheelchair or bicycle along, to, from, through, over, up and down the Existing Footbridge Supports, Connections and Extensions.
- (h) There are reserved unto the Government, its officers, agents, contractors, workmen and other duly authorized personnel free of all costs and charges:
- (i) all necessary rights of ingress, egress and regress to and from the lot for the purposes of erecting, installing, repairing and maintaining street lightings, traffic signs, traffic signals and other forms of equipment on the external part or parts of the Existing Footbridge and within the lot which in the opinion of the Director (whose opinion is final and binding on the Grantee) are considered necessary for regulating vehicular and pedestrian traffic;
- (ii) all necessary rights of ingress, egress and regress to and from the lot for the purposes of inspecting, checking, supervising, managing, keeping, repairing and maintaining the Existing Footbridge and carrying out site investigation and survey as necessary for its reconstruction and renovation; and

(iii) the right to connect the Existing Footbridge to the Existing Footbridge Supports, Connections and Extensions.

- (l) The Grantee shall at his own expense provide temporary public access to and from the Existing Footbridge 24 hours a day free of charge without any interruption to the satisfaction of the Commissioner for Transport whenever access to and from the Existing Footbridge is affected by the building works carried out by the Grantee.

(II) Provisions under the principal deed of mutual covenant:

Section B – Definitions

“Commercial Development” means and includes those parts of the Estate constructed or to be constructed in accordance with the Approved Plans for commercial or retail use and including the external walls of the said parts of the Estate, the external walls of the Estate from the floor slab level of 4th Floor to the ceiling level of 6th Floor (whether or not the parts of Estate enclosed by such external walls form parts of the Commercial Development), (excluding those external walls forming parts of the PSC Items) the spaces provided pursuant to Special Condition No.(43)(b) of the Government Grant for parking of motor vehicles and motor cycles belonging to the occupiers of the Commercial Development and their bona-fide guests, visitors or invitees (including the B3 Commercial Car Parking Spaces), the loading and unloading spaces of goods vehicles provided pursuant to Special Condition No.(44)(a)(ii) of the Government Grant and designated for use by the Commercial Development, the associated driveway and circulation areas, staircases, (in the event that the said parts of the Estate is situated immediately above the Tai Wai Station) all the slabs of the said parts of the Estate above the upper boundary of the Tai Wai Station including all the slabs and finishes above the water-proofing membrane and system and associated protection immediately above, and all utilities, services, trenches, pits and facilities which serve the Commercial Development or any part thereof, as well as all the external finishes of the Commercial Development, part of the 24-hour Walkway, parts of the Pedestrian Link, all those parts of the Greenery Areas which serve the Commercial Development as a whole (which shall be designated as part of the Commercial Common Areas in the Sub-Deed of Mutual Covenant of the Commercial Development), the parapet wall of the podium, the Bicycle Park, the Cycle Track, the Covered Footbridges (whether within or outside the boundary of the Land) and the Existing Footbridge Supports, Connections and Extensions, but excluding those parts forming parts of the Residential Development, the Residential Car Park, the Government Accommodation, the Estate Common Areas, the Residential Common Areas, the Residential Car Park Common Areas and the B3 Commercial Car Park Common Areas, and for the purpose of identification only as shown (where possible and capable of being shown) coloured orange and orange hatched black on the floor plans annexed to the Principal Deed of Mutual Covenant.

“Covered Footbridges” means the two single-storey covered footbridges together with all supports and connections as shall be required or approved by the Director in the approximate positions shown and marked “**PROPOSED FB1**” and “**PROPOSED FB2**” on the plan annexed to the Government Grant constructed or to be constructed in accordance with Special Condition No.(35)(a)(i) of the Government Grant so that pedestrian access can be gained over the Covered Footbridges to and from the Pedestrian Link.

Information on public facilities and public open spaces

公共設施及公眾休憩用地的資料

"Estate Common Areas" means those parts of the Estate which are intended for use by Owners of the Estate as a whole and not for the sole benefit of any Owner or group of Owners of the Estate including, but not limited to all those parts of the Greenery Areas which serve the Estate as a whole, all the slabs of the said parts of the Estate above the upper boundary of the Tai Wai Station including all the slabs above the water-proofing membrane and system and associated protection immediately above, all utilities, services, trenches, pits and facilities which serve the Estate, as well as all the finishes of the Estate, parts of the Setting-back Area, part of the 24-hour Walkway, parts of the Pedestrian Link, the Drainage Reserve or the New Drainage Reserve (as the case may be), the Waterworks Reserve, driveways, lifts, run in and out, the Public Lay-By, the PSC Lay-Bys, the Existing Public Toilet Items, the PSC Items, the PTI Items, cavity walls and diaphragm walls of the Basement Level 4 to the Basement Level 1, external walls, finishes and architectural features below the ceiling of 3rd Floor (excluding those parts of external walls forming parts of the Commercial Development and the finishes and architectural features thereof and thereat), external walls of the drum ramp above the ceiling level of 6th Floor up to the roof level, ramps, lift shafts, shuttle lifts, footpaths, staircases, landings, corridors and passages; pump rooms, transformer room, main switch room, electricity rooms, fire services control room, master meter cabinet and water meter room, fuel tank rooms, street fire hydrant and sprinkler and fire services pump room, fan rooms, sprinkler control valve room, pipe ducts, emergency generator rooms, air duct shaft, refuse storage and material recovery chamber; refuse collection point and spaces for the parking, loading and unloading of refuse collection vehicles provided pursuant to Special Condition No.(52)(b)(i) of the Government Grant; parapet walls, structural walls and columns, the foundations and other structural elements of the buildings erected on the Estate; management office, security room, guard rooms, caretaker's quarters, office for Owners Committee and/or Owners Corporation, stores, lavatories and any other space on or in the Estate used for office of caretaker(s) or other accommodation of the Owners Committee or the Owners Corporation and all other communal areas within the Estate not used for the sole benefit of any Owner or group of Owners of the Estate (but excluding all parts of the Commercial Development, the Residential Common Areas, the Residential Car Park Common Areas, the B3 Commercial Car Park Common Areas and those areas forming parts of other common areas as designated or to be designated in the Sub-Deed of Mutual Covenant or Deed Poll to be executed by the First Owner pursuant to the Principal Deed of Mutual Covenant). The Estate Common Areas in Phase 1 and Phase 2 are for the purpose of identification only as shown (where possible and capable of being shown) coloured green, green hatched black and green cross-hatched black on the plans annexed to the Principal Deed of Mutual Covenant and as shown (where possible and capable of being shown) coloured green, green hatched black and green cross-hatched black (for those parts within Phase 1) and coloured green dash hatched red (for those parts within Phase 2) on the Common Areas demarcation plans annexed to the Principal Deed of Mutual Covenant. The Estate Common Areas in other Phase(s) shall be identified on plans to be annexed to any Sub-Deed of Mutual Covenant or Deed Poll to be executed in respect of such other Phases.

"Existing Footbridge" means the existing footbridge shown and marked as "**EXISTING FB**" on the plan annexed to the Government Grant together with all supports and connections as shall be required or approved by the Director in accordance with Special Condition No.(35)(a)(ii) of the Government Grant.

"Existing Footbridge Supports, Connections and Extensions" means those supports, connections and extensions to the Existing Footbridge provided and constructed or to be provided and constructed in accordance with Special Condition No.(35)(a)(ii) of the Government Grant so that pedestrian and cyclist access can be gained over the Existing Footbridge to and from the Pedestrian Link.

Second Schedule, Part II

Clause 4(c). The public shall have the right at all times and during the existence of the Covered Footbridges and the Existing Footbridge Supports, Connections and Extensions for all lawful purposes freely and without payment of any nature whatsoever without any interruption to pass and repass on foot or by wheelchair or bicycle along, to, from, through, over, up and down the Covered Footbridges and the Existing Footbridge Supports, Connections and Extensions in accordance with Special Condition No.(35)(e)(iv) and (v) of the Government Grant.

Clause 5. There are reserved unto the Government, its officers, agents, contractors, workmen and other duly authorized personnel free of all costs and charges:

- (a) all necessary rights of ingress, egress and regress to and from the Land for the purposes of erecting, installing, repairing and maintaining street lightings, traffic signs, traffic signals and other forms of equipment on the external part or parts of the Existing Footbridge and within the Land which in the opinion of the Director (whose opinion is final and binding) are considered necessary for regulating vehicular and pedestrian traffic;
- (b) all necessary rights of ingress, egress and regress to and from the Land for the purposes of inspecting, checking, supervising, managing, keeping, repairing and maintaining the Existing Footbridge and carrying out site investigation and survey as necessary for its reconstruction and renovation; and
- (c) the right to connect the Existing Footbridge to the Existing Footbridge Supports, Connections and Extensions.

Third Schedule – Clause 1(ar)

Subject to the rights reserved to the First Owner in Clause 3 of Part II of the Second Schedule to the Principal Deed of Mutual Covenant, the rights easements and privileges reserved to FSI as the Owner of the Government Accommodation in the Principal Deed of Mutual Covenant and the Government Grant, the rights granted to and reserved by the Owner of the Tai Wai Station set out in Clause 3 of Part I of the Second Schedule to the Principal Deed of Mutual Covenant and the rights granted to and reserved by KCRC as Owner of the Tai Wai Station under the Station Assignment and the rights granted to the Owner(s) of the Commercial Development under Clause 6 of Part I of the Second Schedule to the Principal Deed of Mutual Covenant, an Owner shall not

...

Use or permit or suffer to be used by any part of the Covered Footbridges and the Existing Footbridge Supports, Connections and Extensions either externally or internally for advertising or for display of any signs, notices or posters whatsoever unless otherwise approval or required by the Director.

Information on public facilities and public open spaces 公共設施及公眾休憩用地的資料

8. 24-hour Walkway

(I) Provisions under the land grant:

Special Condition No.(36)

- (d) (i) The Grantee shall at his own expense and in all respects to the satisfaction of the Director design, provide and thereafter manage and maintain within the lot and any building or buildings erected or to be erected thereon a pedestrian walkway which shall comprise such escalators, passenger lifts, staircases, ramps and other structures as shall be required or approved by the Director (which pedestrian walkway is hereinafter referred to as "**the 24-hour Walkway**") so as to link up the Tai Wai Station, the Existing Public Toilet, the Existing PTI, the New PTI, the Bicycle Park, the Cycle Track, the PSC, the Covered Footbridges, the Existing Footbridge, the PSC Lay-Bys referred to in Special Condition No. (49)(a) of the Land Grant, the Public Lay-By referred to in Special Condition No. (50)(a) of the Land Grant, the ground level of the lot and the footpaths at street level adjacent to the lot. The Grantee shall submit a plan indicating the routing of the 24-hour Walkway to the Director for approval. The decision of the Director as to what constitutes the ground level of the lot and the street level shall be final and binding upon the Grantee.
- (ii) The 24-hour Walkway (excluding the said escalators, passenger lifts, staircases, ramps and other structures) shall have a clear internal width of not less than 4.5 metres.
- (e) The Grantee shall throughout the term agreed to be granted by the Land Grant keep the 24-hour Walkway open for the use by the public 24 hours a day on foot or by wheelchair for all lawful purposes free of charge and without any interruption. The Grantee shall at his own expense keep the escalators and passenger lifts required to be provided under sub-clause (d)(i) of Special Condition No. (36) of the Land Grant in operation 24 hours a day to the satisfaction of the Director.

(II) Provisions under the principal deed of mutual covenant:

Section B – Definitions

"24-hour Walkway" means the pedestrian walkway comprising such escalators, passenger lifts, staircases, ramps and such other structures as shall be approved or required by the Director linking up the Tai Wai Station, the Government Accommodation, the Bicycle Park, the Cycle Track, the Covered Footbridges, the Existing Footbridge, the PSC Lay-Bys, the Public Lay-By, the ground level of the Land and the footpaths at street level adjacent to the Land as constructed and provided in accordance with Special Condition No.(36)(d)(i) of the Government Grant for the purpose of identification only as shown coloured orange hatched black, green hatched black and indigo hatched black on the plans annexed to the Principal Deed of Mutual Covenant.

"Commercial Development" means and includes those parts of the Estate constructed or to be constructed in accordance with the Approved Plans for commercial or retail use and including the external walls of the said parts of the Estate, the external walls of the Estate from the floor slab level of 4th Floor to the ceiling level of 6th Floor (whether or not the parts of Estate enclosed by such external walls form parts of the Commercial Development), (excluding those external walls forming parts of the PSC Items) the spaces provided pursuant to Special Condition No.(43)(b) of the Government Grant for parking of motor vehicles and motor cycles belonging to the occupiers of the Commercial Development and their bona-fide guests, visitors or invitees (including the B3 Commercial Car Parking Spaces), the loading and unloading spaces of goods vehicles provided pursuant to Special Condition No.(44)(a)(ii) of the Government Grant and designated for use by the Commercial Development, the associated driveway and circulation areas, staircases, (in the event that the said parts of the Estate is situated immediately above the Tai Wai Station) all the slabs of the said parts of the Estate above the upper boundary of the Tai Wai Station including all the slabs and finishes above the water-proofing membrane and system and associated protection immediately above, and all utilities, services, trenches, pits and facilities which serve the Commercial Development or any part thereof, as well as all the external finishes of the Commercial Development, part of the 24-hour Walkway, parts of the Pedestrian Link, all those parts of the Greenery Areas which serve the Commercial Development as a whole (which shall be designated as part of the Commercial Common Areas in the Sub-Deed of Mutual Covenant of the Commercial Development), the parapet wall of the podium, the Bicycle Park, the Cycle Track, the Covered Footbridges (whether within or outside the boundary of the Land) and the Existing Footbridge Supports, Connections and Extensions, but excluding those parts forming parts of the Residential Development, the Residential Car Park, the Government Accommodation, the Estate Common Areas, the Residential Common Areas, the Residential Car Park Common Areas and the B3 Commercial Car Park Common Areas, and for the purpose of identification only as shown (where possible and capable of being shown) coloured orange and orange hatched black on the floor plans annexed to the Principal Deed of Mutual Covenant.

Information on public facilities and public open spaces

公共設施及公眾休憩用地的資料

"Estate Common Areas" means those parts of the Estate which are intended for use by Owners of the Estate as a whole and not for the sole benefit of any Owner or group of Owners of the Estate including, but not limited to all those parts of the Greenery Areas which serve the Estate as a whole, all the slabs of the said parts of the Estate above the upper boundary of the Tai Wai Station including all the slabs above the water-proofing membrane and system and associated protection immediately above, all utilities, services, trenches, pits and facilities which serve the Estate, as well as all the finishes of the Estate, parts of the Setting-back Area, part of the 24-hour Walkway, parts of the Pedestrian Link, the Drainage Reserve or the New Drainage Reserve (as the case may be), the Waterworks Reserve, driveways, lifts, run in and out, the Public Lay-By, the PSC Lay-Bys, the Existing Public Toilet Items, the PSC Items, the PTI Items, cavity walls and diaphragm walls of the Basement Level 4 to the Basement Level 1, external walls, finishes and architectural features below the ceiling of 3rd Floor (excluding those parts of external walls forming parts of the Commercial Development and the finishes and architectural features thereof and thereat), external walls of the drum ramp above the ceiling level of 6th Floor up to the roof level, ramps, lift shafts, shuttle lifts, footpaths, staircases, landings, corridors and passages; pump rooms, transformer room, main switch room, electricity rooms, fire services control room, master meter cabinet and water meter room, fuel tank rooms, street fire hydrant and sprinkler and fire services pump room, fan rooms, sprinkler control valve room, pipe ducts, emergency generator rooms, air duct shaft, refuse storage and material recovery chamber; refuse collection point and spaces for the parking, loading and unloading of refuse collection vehicles provided pursuant to Special Condition No.(52)(b)(i) of the Government Grant; parapet walls, structural walls and columns, the foundations and other structural elements of the buildings erected on the Estate; management office, security room, guard rooms, caretaker's quarters, office for Owners Committee and/or Owners Corporation, stores, lavatories and any other space on or in the Estate used for office of caretaker(s) or other accommodation of the Owners Committee or the Owners Corporation and all other communal areas within the Estate not used for the sole benefit of any Owner or group of Owners of the Estate (but excluding all parts of the Commercial Development, the Residential Common Areas, the Residential Car Park Common Areas, the B3 Commercial Car Park Common Areas and those areas forming parts of other common areas as designated or to be designated in the Sub-Deed of Mutual Covenant or Deed Poll to be executed by the First Owner pursuant to the Principal Deed of Mutual Covenant). The Estate Common Areas in Phase 1 and Phase 2 are for the purpose of identification only as shown (where possible and capable of being shown) coloured green, green hatched black and green cross-hatched black on the plans annexed to the Principal Deed of Mutual Covenant and as shown (where possible and capable of being shown) coloured green, green hatched black and green cross-hatched black (for those parts within Phase 1) and coloured green dash hatched red (for those parts within Phase 2) on the Common Areas demarcation plans annexed to the Principal Deed of Mutual Covenant. The Estate Common Areas in other Phase(s) shall be identified on plans to be annexed to any Sub-Deed of Mutual Covenant or Deed Poll to be executed in respect of such other Phases.

Section E – Clause 26

- (a) The Owner of the Commercial Development shall throughout the Term at their own costs and expense keep such part of the 24-hour Walkway as is or may be constructed within the Commercial Development open for use by the public 24 hours a day on foot or by wheelchair for all lawful purposes free of charge and without any interruption in compliance with Special Condition No.(36)(e) of the Government Grant.
- (b) The Owners of the Estate (excluding FSI as the Owner of the Government Accommodation) shall throughout the Term at their own costs and expense keep such part of the 24-hour Walkway as is or may be constructed within the Estate Common Areas open for use by the public 24 hours a day on foot or by wheelchair for all lawful purposes free of charge and without any interruption in compliance with Special Condition No.(36)(e) of the Government Grant.

Second Schedule, Part II – Clause 4(b)

The public shall throughout the term of the Government Grant have the right to use the 24-hour Walkway 24 hours a day on foot or by wheelchair for all lawful purposes free of charge and without any interruption in accordance with Special Condition No.(36)(e) of the Government Grant.

9. Public Lay-By

- (I) Provisions under the land grant:

Special Condition No.(50)

- (a) The Grantee shall on or before 30th day of September, 2022 or within such time limit as may be specified and subject to such conditions as may be approved by the Director at his own expense and in all respects to the satisfaction of the Director provide and thereafter manage and maintain at the ground level of the lot near the junction between Chui Tin Street and Che Kung Miu Road or at such other location as may be determined by the Director (the decision of the Director as to what constitutes the ground level shall be final and binding on the Grantee) not less than one public lay-by measuring 3.5 metres in width and 40.0 metres in aggregate length for the picking up and setting down of passengers from motor vehicles (including taxis) ("**the Public Lay-By**"). The Grantee shall submit or cause to be submitted to the Commissioner for Transport detailed design proposal of the Public Lay-By for his written approval prior to commencement of building works.
- (e) The Public Lay-By provided within the lot in accordance with sub-clause (a) of Special Condition No. (50) of the Land Grant shall be designated as and form part of the Common Areas.
- (f) The Grantee shall throughout the term agreed to be granted by the Land Grant keep the Public Lay-By open for use by the public 24 hours a day free of charge without any interruption to the satisfaction of the Director.

Information on public facilities and public open spaces 公共設施及公眾休憩用地的資料

(II) Provisions under the principal deed of mutual covenant:

Section B – Definitions

"Estate Common Areas" means those parts of the Estate which are intended for use by Owners of the Estate as a whole and not for the sole benefit of any Owner or group of Owners of the Estate including, but not limited to all those parts of the Greenery Areas which serve the Estate as a whole, all the slabs of the said parts of the Estate above the upper boundary of the Tai Wai Station including all the slabs above the water-proofing membrane and system and associated protection immediately above, all utilities, services, trenches, pits and facilities which serve the Estate, as well as all the finishes of the Estate, parts of the Setting-back Area, part of the 24-hour Walkway, parts of the Pedestrian Link, the Drainage Reserve or the New Drainage Reserve (as the case may be), the Waterworks Reserve, driveways, lifts, run in and out, the Public Lay-By, the PSC Lay-Bys, the Existing Public Toilet Items, the PSC Items, the PTI Items, cavity walls and diaphragm walls of the Basement Level 4 to the Basement Level 1, external walls, finishes and architectural features below the ceiling of 3rd Floor (excluding those parts of external walls forming parts of the Commercial Development and the finishes and architectural features thereof and thereat), external walls of the drum ramp above the ceiling level of 6th Floor up to the roof level, ramps, lift shafts, shuttle lifts, footpaths, staircases, landings, corridors and passages; pump rooms, transformer room, main switch room, electricity rooms, fire services control room, master meter cabinet and water meter room, fuel tank rooms, street fire hydrant and sprinkler and fire services pump room, fan rooms, sprinkler control valve room, pipe ducts, emergency generator rooms, air duct shaft, refuse storage and material recovery chamber; refuse collection point and spaces for the parking, loading and unloading of refuse collection vehicles provided pursuant to Special Condition No.(52)(b)(i) of the Government Grant; parapet walls, structural walls and columns, the foundations and other structural elements of the buildings erected on the Estate; management office, security room, guard rooms, caretaker's quarters, office for Owners Committee and/or Owners Corporation, stores, lavatories and any other space on or in the Estate used for office of caretaker(s) or other accommodation of the Owners Committee or the Owners Corporation and all other communal areas within the Estate not used for the sole benefit of any Owner or group of Owners of the Estate (but excluding all parts of the Commercial Development, the Residential Common Areas, the Residential Car Park Common Areas, the B3 Commercial Car Park Common Areas and those areas forming parts of other common areas as designated or to be designated in the Sub-Deed of Mutual Covenant or Deed Poll to be executed by the First Owner pursuant to the Principal Deed of Mutual Covenant). The Estate Common Areas in Phase 1 and Phase 2 are for the purpose of identification only as shown (where possible and capable of being shown) coloured green, green hatched black and green cross-hatched black on the plans annexed to the Principal Deed of Mutual Covenant and as shown (where possible and capable of being shown) coloured green, green hatched black and green cross-hatched black (for those parts within Phase 1) and coloured green dash hatched red (for those parts within Phase 2) on the Common Areas demarcation plans annexed to the Principal Deed of Mutual Covenant. The Estate Common Areas in other Phase(s) shall be identified on plans to be annexed to any Sub-Deed of Mutual Covenant or Deed Poll to be executed in respect of such other Phases.

"Public Lay-By" means the public lay-by provided or to be provided at the ground level of the Land near the junction between Chui Tin Street and Che Kung Miu Road (or at such other location as may be determined by the Director) in all respects to the satisfaction of the Director for the picking up and setting down of passengers from motor vehicles (including taxis) in accordance with Special Condition No.(50)(a) of the Government Grant forming part of the Estate Common Areas;

Second Schedule, Part II – Clause 4(h)

The public shall throughout the term of the Government Grant has the right to use the Public Lay-By 24 hours a day free of charge without any interruption in accordance with Special Condition No.(50)(f) of the Government Grant.

10. Drainage Reserve and New Drainage Reserve

(I) Provisions under the land grant:

Special Condition No.(60)

(a) No building or structure or foundation or support for any building or structure shall be erected or constructed or placed on, over, under, above, below or within the areas of the lot shown coloured pink cross-hatched black, pink cross-hatched black stippled black, pink cross-hatched black stippled red and pink cross-hatched black stippled red hatched black on the plan annexed to the Land Grant (the said coloured areas are hereinafter collectively referred to as "**the Drainage Reserve**") and no trees or shrubs with penetrating roots shall be planted on the Drainage Reserve except:

- (i) the existing structures or supports including the existing drainage pipe and the relocated drainage pipe as referred to in sub-clause (f)(i) of Special Condition No. (60) of the Land Grant, the Existing Water Mains as referred to in sub-clause (i) of Special Condition No. (61) of the Land Grant, the Existing Public Toilet and the Existing PTI which are erected or constructed or placed on, over, under, above, below or within the Drainage Reserve at the date of the Land Grant;
- (ii) the New PTI;
- (iii) the vehicular access road at grade;
- (iv) the public passageway at grade;
- (v) the PSC Lay-Bys and the Public Lay-By; and
- (vi) any other structure or structures as may be approved by the Director.

Information on public facilities and public open spaces

公共設施及公眾休憩用地的資料

- (f) (i) The Grantee shall, upon demand by the Director of Drainage Services, at his own expense and in all respects to the satisfaction of the Director of Drainage Services divert the existing drainage pipe now lying within the Drainage Reserve as shown by the red line on the plan annexed to the Land Grant to a new location as shown by the green line on the plan annexed to the Land Grant ("**the diversion work**"). Upon completion of the diversion work, the Drainage Reserve shall be reduced to a smaller area as shown coloured pink cross-hatched black stippled black, pink cross-hatched black stippled red and pink cross-hatched black stippled red hatched black on the plan annexed to the Land Grant ("**the New Drainage Reserve**") and the provisions contained in sub-clauses (a) to (e) of Special Condition No. (60) of the Land Grant shall apply to the New Drainage Reserve.
- (ii) Prior to the commencement of the diversion work, the Grantee shall obtain the prior written approval of the Director of Drainage Services and shall take all necessary precautionary measures to ensure that the diversion work will not affect the operation of the existing drainage system within the Drainage Reserve.
- (II) Provisions under the principal deed of mutual covenant:

Section B – Definitions

"Drainage Reserve" means those areas of the Land shown coloured pink cross-hatched black, pink cross-hatched black stippled black, pink cross-hatched black stippled red and pink cross-hatched black stippled red hatched black on the plan attached to the Government Grant and referred to under Special Condition No.(60)(a) of the Government Grant;

"Estate Common Areas" means those parts of the Estate which are intended for use by Owners of the Estate as a whole and not for the sole benefit of any Owner or group of Owners of the Estate including, but not limited to all those parts of the Greenery Areas which serve the Estate as a whole, all the slabs of the said parts of the Estate above the upper boundary of the Tai Wai Station including all the slabs above the water-proofing membrane and system and associated protection immediately above, all utilities, services, trenches, pits and facilities which serve the Estate, as well as all the finishes of the Estate, parts of the Setting-back Area, part of the 24-hour Walkway, parts of the Pedestrian Link, the Drainage Reserve or the New Drainage Reserve (as the case may be), the Waterworks Reserve, driveways, lifts, run in and out, the Public Lay-By, the PSC Lay-Bys, the Existing Public Toilet Items, the PSC Items, the PTI Items, cavity walls and diaphragm walls of the Basement Level 4 to the Basement Level 1, external walls, finishes and architectural features below the ceiling of 3rd Floor (excluding those parts of external walls forming parts of the Commercial Development and the finishes and architectural features thereof and thereat), external walls of the drum ramp above the ceiling level of 6th Floor up to the roof level, ramps, lift shafts, shuttle lifts, footpaths, staircases, landings, corridors and passages; pump rooms, transformer room, main switch room, electricity rooms, fire services control room, master meter cabinet and water meter room, fuel tank rooms, street fire hydrant and sprinkler and fire services pump room, fan rooms, sprinkler control valve room, pipe ducts, emergency generator rooms, air duct shaft, refuse storage and material recovery chamber; refuse collection point and spaces for the parking, loading and unloading of refuse collection vehicles provided pursuant to Special Condition No.(52)(b)(i) of the Government Grant; parapet walls, structural walls and columns, the foundations and other structural elements of the buildings erected on the Estate; management office, security room, guard rooms, caretaker's quarters, office for Owners Committee and/or Owners Corporation, stores, lavatories and any other space on or in the Estate used for office of caretaker(s) or other accommodation of the Owners Committee or the Owners Corporation and all other communal areas within the Estate not used for the sole benefit of any Owner or group of Owners of the Estate (but excluding all parts of the Commercial Development, the Residential Common Areas, the Residential Car Park Common Areas, the B3 Commercial Car Park Common Areas and those areas forming parts of other common areas as designated or to be designated in the Sub-Deed of Mutual Covenant or Deed Poll to be executed by the First Owner pursuant to the Principal Deed of Mutual Covenant). The Estate Common Areas in Phase 1 and Phase 2 are for the purpose of identification only as shown (where possible and capable of being shown) coloured green, green hatched black and green cross-hatched black on the plans annexed to the Principal Deed of Mutual Covenant and as shown (where possible and capable of being shown) coloured green, green hatched black and green cross-hatched black (for those parts within Phase 1) and coloured green dash hatched red (for those parts within Phase 2) on the Common Areas demarcation plans annexed to the Principal Deed of Mutual Covenant. The Estate Common Areas in other Phase(s) shall be identified on plans to be annexed to any Sub-Deed of Mutual Covenant or Deed Poll to be executed in respect of such other Phases.

Information on public facilities and public open spaces

公共設施及公眾休憩用地的資料

"New Drainage Reserve" means, upon completion of the diversion work within the Drainage Reserve as required under Special Condition No.(60)(f) of the Government Grant, the area of the Land as shown coloured pink cross-hatched black stippled black, pink cross-hatched black stippled red and pink cross-hatched black stippled red hatched black on the plan annexed to the Government Grant and referred to under the aforesaid Special Condition No.(60)(f);

Section E – Clause 20

The Owners shall throughout the Term, in accordance with Special Condition No.(60)(d) of the Government Grant, permit the Director and his duly authorised officers, contractors, his or their workmen with or without tools, equipment, machinery or motor vehicles unrestricted ingress, egress and regress at all times to, from and through the Land for the purposes of laying, inspecting, repairing and maintaining any drains, sewers, channels, drainage facilities and all other services running across, through or under the Drainage Reserve or the New Drainage Reserve (as the case may be) which the Director may require or authorise.

Section I – Clause 1(b)(xviii)

Without in any way limiting the generality of the foregoing, the Manager shall have the following powers and duties, namely

...

To permit the Director and his duly authorised officers, contractors, his or their workmen with or without tools, equipment, machinery or motor vehicles at all times to enter the Land and provide access for unrestricted ingress, egress and regress to, from and through the Land for the purposes of laying, inspecting, repairing and maintaining any drains, sewers, channels, drainage facilities and all other services running across, through or under the Drainage Reserve and the New Drainage Reserve which the Director may require or authorise as referred to under Special Conditions Nos.(60)(d) and (f)(i) respectively of the Government Grant.

11. Setting-back Area

(I) Provisions under the land grant:

Special Condition No.(62)

(a) Subject to Special Condition No. (60) of the Land Grant, except with the prior written consent of the Director, no building or structure or support for any building or structure shall be erected or constructed or placed, and no object or material of whatsoever nature shall be stored or placed on, over or above the ground level of those parts of the lot shown coloured pink hatched black and pink cross-hatched black stippled red hatched black on the plan annexed to the Land Grant (collectively, "**the Setting-back Area**").

(b) Notwithstanding the provision in sub-clause (a) of Special Condition No. (62) of the Land Grant, the Grantee may erect or allow to be erected on the Setting-back Area such landscaping and recreational facilities, canopies, covered walkway, other structures as shown on the Approved Landscape Master Plan or any master layout plan or plans approved by the Town Planning Board and such other structures or facilities as may be approved in writing by the Director.

(d) The Grantee shall throughout the term agreed to be granted by the Land Grant keep the Setting-back Area open for use by the public for all lawful purposes 24 hours a day free of charge without any interruption to the satisfaction of the Director.

(h) Throughout the term agreed to be granted by the Land Grant the Grantee shall at his own expense manage and maintain the Setting-back Area and all the structures and facilities erected or to be erected thereon in accordance with sub-clause (b) of Special Condition No. (62) of the Land Grant in good and substantial repair and condition in all respects to the satisfaction of the Director.

Information on public facilities and public open spaces 公共設施及公眾休憩用地的資料

(II) Provisions under the principal deed of mutual covenant:

Section B – Definitions

"Estate Common Areas" means those parts of the Estate which are intended for use by Owners of the Estate as a whole and not for the sole benefit of any Owner or group of Owners of the Estate including, but not limited to all those parts of the Greenery Areas which serve the Estate as a whole, all the slabs of the said parts of the Estate above the upper boundary of the Tai Wai Station including all the slabs above the water-proofing membrane and system and associated protection immediately above, all utilities, services, trenches, pits and facilities which serve the Estate, as well as all the finishes of the Estate, parts of the Setting-back Area, part of the 24-hour Walkway, parts of the Pedestrian Link, the Drainage Reserve or the New Drainage Reserve (as the case may be), the Waterworks Reserve, driveways, lifts, run in and out, the Public Lay-By, the PSC Lay-Bys, the Existing Public Toilet Items, the PSC Items, the PTI Items, cavity walls and diaphragm walls of the Basement Level 4 to the Basement Level 1, external walls, finishes and architectural features below the ceiling of 3rd Floor (excluding those parts of external walls forming parts of the Commercial Development and the finishes and architectural features thereof and thereat), external walls of the drum ramp above the ceiling level of 6th Floor up to the roof level, ramps, lift shafts, shuttle lifts, footpaths, staircases, landings, corridors and passages; pump rooms, transformer room, main switch room, electricity rooms, fire services control room, master meter cabinet and water meter room, fuel tank rooms, street fire hydrant and sprinkler and fire services pump room, fan rooms, sprinkler control valve room, pipe ducts, emergency generator rooms, air duct shaft, refuse storage and material recovery chamber; refuse collection point and spaces for the parking, loading and unloading of refuse collection vehicles provided pursuant to Special Condition No.(52)(b)(i) of the Government Grant; parapet walls, structural walls and columns, the foundations and other structural elements of the buildings erected on the Estate; management office, security room, guard rooms, caretaker's quarters, office for Owners Committee and/or Owners Corporation, stores, lavatories and any other space on or in the Estate used for office of caretaker(s) or other accommodation of the Owners Committee or the Owners Corporation and all other communal areas within the Estate not used for the sole benefit of any Owner or group of Owners of the Estate (but excluding all parts of the Commercial Development, the Residential Common Areas, the Residential Car Park Common Areas, the B3 Commercial Car Park Common Areas and those areas forming parts of other common areas as designated or to be designated in the Sub-Deed of Mutual Covenant or Deed Poll to be executed by the First Owner pursuant to the Principal Deed of Mutual Covenant). The Estate Common Areas in Phase 1 and Phase 2 are for the purpose of identification only as shown (where possible and capable of being shown) coloured green, green hatched black and green cross-hatched black on the plans annexed to the Principal Deed of Mutual Covenant and as shown (where possible and capable of being shown) coloured green, green hatched black and green cross-hatched black (for those parts within Phase 1) and coloured green dash hatched red (for those parts within Phase 2) on the Common Areas demarcation plans annexed to the Principal Deed of Mutual Covenant. The Estate Common Areas in other Phase(s) shall be identified on plans to be annexed to any Sub-Deed of Mutual Covenant or Deed Poll to be executed in respect of such other Phases.

"Setting-back Area" means those areas shown coloured pink hatched black and pink cross-hatched black stippled red hatched black on the plan annexed to the Government Grant as referred to under Special Condition No.(62)(a) of the Government Grant;

Second Schedule, Part II – Clause 4(d)

The public shall throughout the term of the Government Grant have the right to use the Setting-back Area 24 hours a day for all lawful purposes free of charge and without any interruption in accordance with Special Condition No.(62)(d) of the Government Grant.

B. Any facilities that are required under the land grant to be managed, operated or maintained for public use at the expense of the owners of the residential properties in the development

1. Green Areas and Structures

(I) Provisions under the land grant:

Special Condition No.(5)(a)

The Grantee shall:

- (i) on or before the 30th day of September 2022, or such other date or dates as may be approved by the Director, at his own expense, in such manner with such materials and to such standards, levels, alignment and design as the Director shall approve and in all respects to the satisfaction of the Director:
 - (I) lay and form those portions of future public roads shown coloured green on the plan annexed to the Land Grant ("**the Green Areas**"); and
 - (II) provide and construct such bridges, tunnels, over-passes, under-passes, culverts, viaducts, flyovers, pavements, roads or such other structures as the Director in his sole discretion may require ("**the Structures**")

so that building, vehicular, pedestrian and cyclist traffic may be carried on the Green Areas;

- (ii) on or before the 30th day of September 2022, or such other date or dates as may be approved by the Director, at his own expense and to the satisfaction of the Director, surface, kerb and channel the Green Areas and provide the same with such gullies, sewers, drains, fire hydrants with pipes connected to water mains, services street lights, traffic signs, street furniture, road markings and plant as the Director may require; and
- (iii) maintain at his own expense the Green Areas together with the Structures and all structures, surfaces, gullies, sewers, drains, fire hydrants, services, street lights, traffic signs, street furniture, road markings and plant constructed, installed and provided thereon or therein to the satisfaction of the Director until such time as possession of the Green Areas has been re-delivered to the Government by the Grantee in accordance with Special Condition No. (6) of the Land Grant.

Information on public facilities and public open spaces 公共設施及公眾休憩用地的資料

Special Condition No. (6)

For the purpose only of carrying out the necessary works specified in Special Condition No.(5) of the Land Grant, the Grantee shall on the date of the Land Grant be granted possession of the Green Areas. The Green Areas or any part or parts thereof shall be re-delivered to the Government on demand and in any event the Green Areas shall be deemed to have been re-delivered to the Government by the Grantee on the date of a letter from the Director indicating that these Conditions have been complied with to his satisfaction. The Grantee shall at all reasonable times while he is in possession of the Green Areas or any part or parts thereof allow free access over and along the Green Areas or such part or parts thereof for all Government and public vehicular, pedestrian and cyclist traffic and shall ensure that such access shall not be interfered with or obstructed by the carrying out of the works whether under Special Condition No. (5) of the Land Grant or otherwise.

Special Condition No. (7)

The Grantee shall not without the prior written consent of the Director use the Green Areas for the purpose of storage or for the erection of any temporary structure or for any purposes other than the carrying out of the works specified in Special Condition No. (5) of the Land Grant.

Special Condition No. (8)(a)

The Grantee shall at all reasonable times while he is in possession of the Green Areas or any part or parts thereof :

- (i) permit the Government, the Director and his officers, contractors and agents and any persons authorized by the Director, the right of free and unrestricted ingress, egress and regress to, from and through the lot and the Green Areas or any part or parts thereof for the purpose of inspecting, checking and supervising any works to be carried out in compliance with Special Condition No.(5)(a) hereof and the carrying out, inspecting, checking and supervising of the works under Special Condition No.(5)(b) hereof and any other works which the Director may consider necessary in the Green Areas or any part or parts thereof;
- (ii) permit the Government and the relevant public utility companies authorized by the Government the right of free and unrestricted ingress, egress and regress to, from and through the lot and the Green Areas or any part or parts thereof as the Government or the relevant public utility companies may require for the purpose of any works to be carried out in, upon or under the Green Areas or any part or parts thereof or any adjoining land including but not limited to the laying and subsequent maintenance of all pipes, wire, conduits, cable-ducts and other conducting media and ancillary equipment necessary for the provision of telephone, electricity, gas (if any) and other services intended to serve the lot or any adjoining or neighbouring land or premises, and the Grantee shall co-operate fully with the Government and also with the relevant public utility companies duly authorized by the Government on all matters relating to any of the aforesaid works to be carried out with the Green Areas or any part or parts thereof; and

- (iii) permit the officers of the Water Authority and such other persons as may be authorized by them the right of free and unrestricted ingress, egress and regress to, from and through the lot and the Green Areas or any part or parts thereof as the officers of the Water Authority or such authorized persons may require for the purpose of carrying out any works in relation to the operation, maintenance, repairing, replacement and alteration of any other waterworks installations with the Green Areas or any part or parts thereof.

(II) Provisions under the principal deed of mutual covenant:

Section B – Definitions

“Green Areas” means those portions of future public roads shown coloured green on the plan annexed to the Government Grant as referred to under Special Condition No.(5)(a)(i)(I) of the Government Grant;

“Structures” means the Structures as defined in Special Condition No.(5)(a)(i)(II) of the Government Grant;

“Other Structures and Facilities” means all structures, surfaces, gullies, sewers, drains, fire hydrants, services, street lights, traffic signs, street furniture, road markings and plant constructed, installed and provided on or in the Green Areas to the satisfaction of the Director in accordance with Special Condition No.(5)(a)(iii) of the Government Grant.

Section E – Clause 18

- (a) The Owners (excluding the Owner of the Tai Wai Station and FSI as the Owner of the Government Accommodation) shall at their own expense maintain the Green Areas together with the Structures and the Other Structures and Facilities to the satisfaction of the Director in accordance with Special Condition No.(5)(a)(iii) of the Government Grant until such time as possession of the Green Areas have been re-delivered to the Government in accordance with Special Condition No.(6) of the Government Grant.
- (b) The Owners shall at all reasonable times while the Owners are in possession of the Green Areas or any part or parts thereof allow free access over and along the Green Areas or such part or parts thereof for all Government and public vehicular and pedestrian and cyclist traffic and shall ensure that such access shall not be interfered with or obstructed by the carrying out of the works whether under Special Condition No.(5) of the Government Grant or otherwise.
- (c) The Owners shall at all reasonable times while they are in possession of the Green Areas or any part or parts thereof permit the Director, his officers, contractors, agents and any other persons authorized by him, the Government and the relevant public utility companies authorised by the Government, the officers of the Water Authority and such other persons as may be authorised by the Water Authority, the right of free and unrestricted ingress, egress and regress to, from and through the Land and the Green Areas or part or parts thereof for the purpose of carrying out, inspecting and supervising of the works as referred to under Special Condition No.(8)(a) of the Government Grant.

Information on public facilities and public open spaces 公共設施及公眾休憩用地的資料

Section I – Clause 1(b)(xvi)

Without in any way limiting the generality of the foregoing, the Manager shall have the following powers and duties, namely

...

To permit the Director, his officers, contractors and agents and any other persons authorized by him, the Government and public utilities company authorised by the Government and the officers of the Water Authority and such other persons as may be authorized by the Water Authority to enter into the Land and the Green Areas and provide access for the ingress, egress and regress to, from and through the Land and the Green Areas as may be required for the purpose of carrying out, inspecting, checking and supervising any works as referred to under Special Condition No.8(a) of the Government Grant.

Section J – Clause 2(a)(i)

There shall be established and maintained by the Manager one Special Fund which shall be comprised of the following books of separate accounts:

...

An estate account of the Special Fund for the purposes of meeting the cost of major works of a capital nature or of a kind not expected to be incurred annually in respect of the Existing Public Toilet Items, the PSC Items and the PTI Items which are the obligations of the Owners (save and except FSI as the Owner of the Government Accommodation) under Clause 10 of Section E of the Principal Deed of Mutual Covenant, the Slope and Retaining Structures, the prestressed ground anchors (if any), the Green Areas, the Structures and the Other Structures and Facilities, the Estate Common Areas and/or the Estate Common Services and Facilities which includes, but is not limited to, expenses for the renovation, improvement and repair of the Existing Public Toilet Items, the PSC Items and the PTI Items, the Slope and Retaining Structures, the prestressed ground anchors (if any), the Green Areas, the Structures and the Other Structures and Facilities, the Estate Common Areas and/or the Estate Common Services and Facilities, the purchase, setting up, replacement, improvement and addition of installations, systems, equipment, tools, plant and machines for the Estate Common Areas and/or the Estate Common Services and Facilities and the costs of the relevant investigation works and professional services.

Section J – Clause 4(i)(i)

(i) The Manager shall prepare the following budgets:-

- (i) an Estate Management Budget which shall show the estimated expenditure for the management and maintenance of the Existing Public Toilet Items, the PSC Items and the PTI Items which are the obligations of the Owners (save and except FSI as the Owner of the Government Accommodation) under Clause 10 of Section E of the Principal Deed of Mutual Covenant, the Slope and Retaining Structures, the prestressed ground anchors (if any), the Green Areas, the Structures and the Other Structures and Facilities, the Estate Common Areas and the Estate Common Services and Facilities including the contribution to the estate account of the Special Fund and an appropriate portion of the Manager's Remuneration but excluding expenditure attributable to the Residential Development, the Commercial Development or the Residential Parking Spaces.

2. Existing Public Toilet Items, PTI Items and PSC Items

(I) Provisions under the land grant:

Special Condition No. (16)

- (i) (i) The Grantee shall throughout the term agreed to be granted by the Land Grant at his own expense and in all respects to the satisfaction of the Director maintain the following items ("**the Existing Public Toilet Items**"):
 - (I) the external finishes of the Existing Public Toilet and the structure of all walls, columns, beams, ceilings, roof slabs, carriageway or floor slabs and any other structural elements of, in, around, within, above and below the Existing Public Toilet;
 - (II) all lifts, escalators and stairways serving the Existing Public Toilet and the remainder of the development on the lot;
 - (III) all building services installations, plant and equipment (including but not limited to portable and non-portable fire services installation equipment) forming part of the system serving the Existing Public Toilet and the remainder of the development on the lot;
 - (IV) all of the structural slabs under the Existing Public Toilet together with the drainage systems therein and thereunder; and
 - (v) all other common parts and facilities serving the Existing Public Toilet and the remainder of the development on the lot.
- (ii) The Grantee shall indemnify and keep indemnified the Government and F.S.I. against all liabilities, damages, expenses, claims, cost, demands, charges, actions and proceedings of whatsoever nature arising out of or as a consequence of the failure of the Grantee to maintain the Existing Public Toilet Items.
- (iii) For the purpose of this sub-clause (i), the expression "Grantee" shall exclude F.S.I.

Information on public facilities and public open spaces 公共設施及公眾休憩用地的資料

Special Condition No. (19)

- (a) The Grantee shall throughout the term agreed to be granted by the Land Grant at his own expense and in all respects to the satisfaction of the Director maintain the following items ("**the PTI Items**"):
- (i) the external finishes of the Existing PTI and the New PTI and the structure of all walls, columns, beams, ceilings, roof slabs, carriageway or floor slabs and any other structural elements of, in, around, within, above and below the Existing PTI and the New PTI;
 - (ii) all lifts, escalators and stairways serving the Existing PTI or the New PTI or both and the remainder of the development on the lot;
 - (iii) all building services installations, plant and equipment (including but not limited to portable and non-portable fire services installation equipment) forming part of the system serving the Existing PTI or the New PTI or both and the remainder of the development on the lot;
 - (iv) all of the structural slabs under the Existing PTI or the New PTI or both together with the drainage systems therein and thereunder; and
 - (V) all other common parts and facilities serving the Existing PTI or the New PTI or both and the remainder of the development on the lot.
- (b) The Grantee shall indemnify and keep indemnified the Government and F.S.I. against all liabilities, damages, expenses, claims, costs, demands, charges, actions and proceedings of whatsoever nature arising out of or as a consequence of the failure of the Grantee to maintain the PTI Items.
- (c) For the purpose of this Special Condition, the expression "Grantee" shall exclude F.S.I.

Special Condition No. (22)

- (I) (i) The Grantee shall throughout the term agreed to be granted by the Land Grant at his own expense and in all respects to the satisfaction of the Director maintain the following items ("**the PSC Items**"):
- (I) the external finishes and the external façade of the PSC and the structure of all walls, columns, beams, ceilings, roof slabs, carriageway or floor slabs and any other structural elements of, in, around, within, above and below the PSC;
 - (II) all lifts, escalators and stairways serving the PSC and the remainder of the development on the lot;
 - (III) all building services installations, plant and equipment (including but not limited to portable and non-portable fire services installation equipment) forming part of the system serving the PSC and the remainder of the development on the lot;
 - (IV) all of the structural slabs under the PSC together with the drainage systems therein and thereunder; and

- (V) all other common parts and facilities serving the PSC and the remainder of the development on the lot.
 - (ii) The Grantee shall indemnify and keep indemnified the Government and F.S.I. against all liabilities, damages, expenses, claims, cost, demands, charges, actions and proceedings of whatsoever nature arising out of or as a consequence of the failure of the Grantee to maintain the PSC Items.
 - (iii) For the purpose of this sub-clause (I), the expression "Grantee" shall exclude F.S.I.
- (II) Provisions under the principal deed of mutual covenant:

Section B – Definitions

"Existing Public Toilet Items" means (i) the external finishes of the Existing Public Toilet and the structure of all walls, columns, beams, ceiling, roof slabs, carriageway or floor slabs and any other structural elements of, in, around, within, above and below the Existing Public Toilet; (ii) all lifts, escalators and stairways serving the Existing Public Toilet and the remainder of the Development; (iii) all building services installations, plant and equipment (including but not limited to portable and non-portable fire services installation equipment) forming part of the system serving the Existing Public Toilet and the remainder of the Development; (iv) all of the structural slabs under the Existing Public Toilet together with the drainage systems therein and thereunder; and (v) and all other common parts and facilities serving the Existing Public Toilet and the remainder of the Development, referred to in Special Condition No.(16)(i)(i) of the Government Grant.

"PTI Items" means (i) the external finishes of the Existing PTI and the New PTI and the structure of all walls, columns, beams, ceilings, roof slabs, carriageway or floor slabs and any other structural elements of, in, around, within, above and below the Existing PTI and the New PTI; (ii) all lifts, escalators and stairways serving the Existing PTI or the New PTI or both and the remainder of the Development; (iii) all building services installations, plant and equipment (including but not limited to portable and non-portable fire services installation equipment) forming part of the system serving the Existing PTI or the New PTI or both and the remainder of the Development; (iv) all of the structural slabs under the Existing PTI or the New PTI or both together with the drainage systems therein and thereunder; and (v) all other common parts and facilities serving the Existing PTI or the New PTI or both and the remainder of the Development, as referred to in Special Condition No.(19)(a) of the Government Grant.

"PSC Items" means (i) the external finishes and the external façade of the PSC and the structure of all walls, columns, beams, ceilings, roof slabs, carriageway or floor slabs and any other structural elements of, in, around, within, above and below the PSC; (ii) all lifts, escalators and stairways serving the PSC and the remainder of the Development; (iii) all building services installations, plant and equipment (including but not limited to portable and non-portable fire services installation equipment) forming part of the system serving the PSC and the remainder of the Development; (iv) all of the structural slabs under the PSC together with the drainage systems therein and thereunder; and (v) all other common parts and facilities serving the PSC and the remainder of the Development, referred to in Special Condition No.(22)(I)(i) of the Government Grant.

Section E – Clause 9

Information on public facilities and public open spaces 公共設施及公眾休憩用地的資料

- (a) The Owner of the Government Accommodation shall be responsible for the maintenance and management of all parts of the Government Accommodation only (excluding the Existing Public Toilet Items, the PSC Items and the PTI Items) but not any other part of the Development nor any areas, facilities or services outside the Land.
- (b) The Owner of the Government Accommodation shall not be liable to make any payment or contribution towards the Management Charges calculated in accordance with Clause 5 of Section J of the Principal Deed of Mutual Covenant or any deposits set out under Clauses 9(a) and 9(c) of Section J of the Principal Deed of Mutual Covenant.

Section E - Clause 10

The Owners (save and except FSI as the Owner of the Government Accommodation) shall, acting by the Manager, be responsible for maintaining, managing and repairing the Existing Public Toilet Items, the PSC Items and the PTI Items in accordance with Special Condition Nos.(16)(i), 22(l)(i) and (19)(a) of the Government Grant respectively and shall indemnify and shall keep indemnified the Government and FSI against all actions, proceedings, liabilities, claims, costs, expenses, damages, charges and demands of whatsoever nature arising out of or as a consequence of a failure to maintain the Existing Public Toilet Items, the PSC Items and the PTI Items.

Section I – Clause 1(b)(xii)

Without in any way limiting the generality of the foregoing, the Manager shall have the following powers and duties, namely

...

To maintain, manage and keep in good repair and condition all parts of

the Existing Public Toilet Items, the PSC Items and the PTI Items which are the obligations of the Owners (save and except FSI as the Owner of the Government Accommodation) under Clause 10 of Section E of the Principal Deed of Mutual Covenant.

Section J – Clause 1(n)

The costs, charges and expenses necessarily and reasonably incurred, in respect of the management of the Estate and the performance of any duty or the exercise of any power by the Manager, shall include but shall not be limited to those next following, and shall be paid by the Owners of the Estate in the manner herein provided :

...

The costs of maintaining, repairing and operating such parts of the Existing Public Toilet Items, the PSC Items and the PTI Items which are the obligations of the Owners (save and except FSI as the Owner of the Government Accommodation) under Clause 10 of Section E of the Principal Deed of Mutual Covenant.

Section J – Clause 4(i)(i)

(i) The Manager shall prepare the following budgets:-

- (i) an Estate Management Budget which shall show the estimated expenditure for the management and maintenance of the Existing Public Toilet Items, the PSC Items and the PTI Items which are the obligations of the Owners (save and except FSI as the Owner of the Government Accommodation) under Clause 10 of Section E of the Principal Deed of Mutual Covenant, the Slope and Retaining Structures, the prestressed ground anchors (if any), the Green Areas, the Structures and the Other Structures and Facilities, the Estate Common Areas and the Estate Common Services and Facilities including the contribution to the estate account of the Special Fund and an appropriate portion of the Manager's Remuneration but excluding expenditure attributable to the Residential Development, the Commercial Development or the Residential Parking Spaces.

Information on public facilities and public open spaces

公共設施及公眾休憩用地的資料

3. Bicycle Park and Cycle Track

(I) Provisions under the land grant:

Special Condition No.(20)

- (a) The Grantee shall on or before 30th day of September, 2022 or within such time limit as may be specified and subject to such conditions as may be approved by the Director at his own expense and in all respects to the satisfaction of the Director erect and construct in a good workmanlike manner and thereafter maintain and manage a bicycle park which shall comprise 330 spaces or such other number as may be approved by the Director and shall be located in close proximity to the New PTI or at such other location as may be determined by the Director for the parking of bicycles of the public ("**the Bicycle Park**"). The Grantee shall submit or cause to be submitted to the Commissioner for Transport detailed design proposal for his written approval prior to commencement of works.
- (c) The Grantee shall throughout the term agreed to be granted by the Land Grant keep the Bicycle Park open for use by the public 24 hours a day except for the period during which the Bicycle Park or any part or parts thereof shall have to be closed temporarily for the purpose of carrying out maintenance works.

Special Condition No. (21)

- (a) The Grantee shall on or before 30th day of September, 2022 or within such time limit as may be specified and subject to such conditions as may be approved by the Director at his own expense and in all respects to the satisfaction of the Director provide and thereafter maintain and manage a cycle track with a clear width of not less than 3.5 metres ("**the Cycle Track**") so as to link up the Bicycle Park and the adjacent cycle tracks and to ensure continuity of the cycle track network of the Sha Tin New Town.
- (e) The Grantee shall throughout the term agreed to be granted by the Land Grant keep the Cycle Track open 24 hours a day free of charge for the passing and repassing of cyclists (whether riding on the cycles or not) without any interruption.

(II) Provisions under the principal deed of mutual covenant:

Section B – Definitions

"Bicycle Park" means the bicycle park constructed or to be constructed in all respects to the satisfaction of the Director and thereafter maintained and managed in accordance with Special Condition No.(20)(a) of the Government Grant for the parking of bicycles by the public forming part of the Commercial Development;

"Cycle Track" means the cycle track provided or to be provided in all respects to the satisfaction of the Director and thereafter maintained and managed in accordance with Special Condition No.(21) of the Government Grant forming part of the Commercial Development so as to link up the Bicycle Park and the adjacent cycle tracks and to ensure continuity of the cycle track network of the Sha Tin New Town;

"Commercial Development" means and includes those parts of the Estate constructed or to be constructed in accordance with the Approved Plans for commercial or retail use and including the external walls of the said parts of the Estate, the external walls of the Estate from the floor slab level of 4th Floor to the ceiling level of 6th Floor (whether or not the parts of Estate enclosed by such external walls form parts of the Commercial Development), (excluding those external walls forming parts of the PSC Items) the spaces provided pursuant to Special Condition No.(43)(b) of the Government Grant for parking of motor vehicles and motor cycles belonging to the occupiers of the Commercial Development and their bona-fide guests, visitors or invitees (including the B3 Commercial Car Parking Spaces), the loading and unloading spaces of goods vehicles provided pursuant to Special Condition No.(44)(a)(ii) of the Government Grant and designated for use by the Commercial Development, the associated driveway and circulation areas, staircases, (in the event that the said parts of the Estate is situated immediately above the Tai Wai Station) all the slabs of the said parts of the Estate above the upper boundary of the Tai Wai Station including all the slabs and finishes above the water-proofing membrane and system and associated protection immediately above, and all utilities, services, trenches, pits and facilities which serve the Commercial Development or any part thereof, as well as all the external finishes of the Commercial Development, part of the 24-hour Walkway, parts of the Pedestrian Link, all those parts of the Greenery Areas which serve the Commercial Development as a whole (which shall be designated as part of the Commercial Common Areas in the Sub-Deed of Mutual Covenant of the Commercial Development), the parapet wall of the podium, the Bicycle Park, the Cycle Track, the Covered Footbridges (whether within or outside the boundary of the Land) and the Existing Footbridge Supports, Connections and Extensions, but excluding those parts forming parts of the Residential Development, the Residential Car Park, the Government Accommodation, the Estate Common Areas, the Residential Common Areas, the Residential Car Park Common Areas and the B3 Commercial Car Park Common Areas, and for the purpose of identification only as shown (where possible and capable of being shown) coloured orange and orange hatched black on the floor plans annexed to the Principal Deed of Mutual Covenant.

Second Schedule, Part II – Clause 4

- (e) The public shall throughout the term of the Government Grant have the right to use the Bicycle Park 24 hours a day except for the period during which the Bicycle Park or any part or parts thereof shall have to be closed temporarily for the purpose of carrying out maintenance works in accordance with Special Condition No.(20)(c) of the Government Grant.
- (f) The Cycle Track shall throughout the term of the Government Grant be kept open 24 hours a day free of charge for the passing or repassing of cyclists (whether riding on the cycles or not) without any interruption in accordance with Special Condition No.(21)(e) of the Government Grant.

Information on public facilities and public open spaces

公共設施及公眾休憩用地的資料

4. Covered Footbridges, Existing Footbridge and Existing Footbridge Supports, Connections and Extensions

(I) Provisions under the land grant:

Special Condition No.(35)

(a) The Grantee shall on or before 30th day of September 2022 or within such time limit as may be specified and subject to such conditions as may be approved by the Director at the Grantee's own expense and in all respects to the satisfaction of the Director:

(i) erect, construct and provide two single-storey covered footbridges together with all supports and connections (including any supports and connections which the Director in his absolute discretion considers necessary for any future extension to the covered footbridges) as shall be required or approved by the Director (collectively, "**the Covered Footbridges**") in the approximate positions shown and marked "**PROPOSED FB 1**" and "**PROPOSED FB 2**" on the plan annexed to the Land Grant so that pedestrian access can be gained over the Covered Footbridges to and from the Pedestrian Link (as defined in Special Condition No. (36)(a) of the Land Grant). The Covered Footbridges shall be constructed with such materials and to such standards, levels, alignment, disposition and designs as shall be required and approved by the Director including but not limited to the provision and construction of such supports, ramps, associated staircases and landings, escalators, lifts, ramps or lifts for disabled persons and such internal and external fittings and fixtures and such lighting fittings as the Director in his sole discretion may require. Each of the Covered Footbridges shall have a clear internal width of 6.0 metres or such other width as may be approved by the Commissioner for Transport and a minimum clear internal headroom of 2.6 metres;

(ii) modify the existing footbridge which is shown and marked as "**EXISTING FB**" on the plan annexed to the Land Grant together with all supports and connections (including any supports and connections which the Director in his absolute discretion considers necessary for any future extension to the existing footbridge) as shall be required or approved by the Director (collectively, "**the Existing Footbridge**") and provide and construct such supports, connections and extensions to the Existing Footbridge in the building or buildings to be erected on the lot (collectively, "**the Existing Footbridge Supports, Connections and Extensions**") so that pedestrian and cyclist access can be gained over the Existing Footbridge to and from the Pedestrian Link (as defined in Special Condition No. (36)(a) of the Land Grant). The modification and extension of the Existing Footbridge shall include provision of a cycle track of 2.8 metres in width or any other width as may be determined by the Commissioner for Transport. The Existing Footbridge Supports, Connections and Extensions shall be constructed with such materials and to such specifications, standards, levels, alignment, disposition and designs and at such points as shall be required and approved by the Director including but not limited to the provision and construction of such supports, ramps, associated staircases and landings, escalators, lifts, ramp(s) or lift(s) for disabled persons and such internal and external fittings and fixtures and such lighting fittings as the Director in his sole discretion may require.

(c) Notwithstanding anything to the contrary contained in these Conditions, throughout the term agreed to be granted by the Land Grant the Grantee shall at his own expense repair, manage and maintain the Covered Footbridges and the Existing Footbridge Supports, Connections and Extensions and any replacement or replacements thereof which may be constructed by the Grantee in accordance with sub-clause (g) of Special Condition No. (35) of the Land Grant in a clean, tidy and good and substantial repair and condition and in all respects to the satisfaction of the Director.

(e) (i) The Covered Footbridges and the Existing Footbridge Supports, Connections and Extensions shall not be used for any purpose other than for the passage of all members of the public on foot or by wheelchair or bicycle.

(ii) The Grantee shall not use or permit or suffer to be used any part of the Covered Footbridges and the Existing Footbridge Supports, Connections and Extensions either externally or internally for advertising or for the display of any signs, notices or posters whatsoever unless otherwise approved or required by the Director.

(iii) The Grantee shall not do or permit or suffer to be done in the Covered Footbridges and the Existing Footbridge Supports, Connections and Extensions anything that may be or become a nuisance or annoyance or that may cause inconvenience or damage to any person or vehicle passing under the Covered Footbridges and the Existing Footbridge Supports, Connections and Extensions or to any owner or occupier of any adjacent or neighbouring lot or lots or premises.

(iv) The Grantee shall throughout the period during which the Covered Footbridges are in existence permit all members of the public for all lawful purposes 24 hours a day freely and without payment of any nature whatsoever without any interruption to pass and repass on foot or by wheelchair or bicycle along, to, from, through, over, up and down the Covered Footbridges.

(v) The Grantee shall throughout the period during which the Existing Footbridge Supports, Connections and Extensions are in existence permit all members of the public for all lawful purposes 24 hours a day freely and without payment of any nature whatsoever without any interruption to pass and repass on foot or by wheelchair or bicycle along, to, from, through, over, up and down the Existing Footbridge Supports, Connections and Extensions.

(I) The Grantee shall at his own expense provide temporary public access to and from the Existing Footbridge 24 hours a day free of charge without any interruption to the satisfaction of the Commissioner for Transport whenever access to and from the Existing Footbridge is affected by the building works carried out by the Grantee.

Information on public facilities and public open spaces 公共設施及公眾休憩用地的資料

(III) Provisions under the principal deed of mutual covenant:

Section B – Definitions

“Commercial Development” means and includes those parts of the Estate constructed or to be constructed in accordance with the Approved Plans for commercial or retail use and including the external walls of the said parts of the Estate, the external walls of the Estate from the floor slab level of 4th Floor to the ceiling level of 6th Floor (whether or not the parts of Estate enclosed by such external walls form parts of the Commercial Development), (excluding those external walls forming parts of the PSC Items) the spaces provided pursuant to Special Condition No.(43)(b) of the Government Grant for parking of motor vehicles and motor cycles belonging to the occupiers of the Commercial Development and their bona-fide guests, visitors or invitees (including the B3 Commercial Car Parking Spaces), the loading and unloading spaces of goods vehicles provided pursuant to Special Condition No.(44)(a)(ii) of the Government Grant and designated for use by the Commercial Development, the associated driveway and circulation areas, staircases, (in the event that the said parts of the Estate is situated immediately above the Tai Wai Station) all the slabs of the said parts of the Estate above the upper boundary of the Tai Wai Station including all the slabs and finishes above the water-proofing membrane and system and associated protection immediately above, and all utilities, services, trenches, pits and facilities which serve the Commercial Development or any part thereof, as well as all the external finishes of the Commercial Development, part of the 24-hour Walkway, parts of the Pedestrian Link, all those parts of the Greenery Areas which serve the Commercial Development as a whole (which shall be designated as part of the Commercial Common Areas in the Sub-Deed of Mutual Covenant of the Commercial Development), the parapet wall of the podium, the Bicycle Park, the Cycle Track, the Covered Footbridges (whether within or outside the boundary of the Land) and the Existing Footbridge Supports, Connections and Extensions, but excluding those parts forming parts of the Residential Development, the Residential Car Park, the Government Accommodation, the Estate Common Areas, the Residential Common Areas, the Residential Car Park Common Areas and the B3 Commercial Car Park Common Areas, and for the purpose of identification only as shown (where possible and capable of being shown) coloured orange and orange hatched black on the floor plans annexed to the Principal Deed of Mutual Covenant.

“Covered Footbridges” means the two single-storey covered footbridges together with all supports and connections as shall be required or approved by the Director in the approximate positions shown and marked “**PROPOSED FB1**” and “**PROPOSED FB2**” on the plan annexed to the Government Grant constructed or to be constructed in accordance with Special Condition No.(35)(a)(i) of the Government Grant so that pedestrian access can be gained over the Covered Footbridges to and from the Pedestrian Link.

“Estate Common Areas” means those parts of the Estate which are intended for use by Owners of the Estate as a whole and not for the sole benefit of any Owner or group of Owners of the Estate including, but not limited to all those parts of the Greenery Areas which serve the Estate as a whole, all the slabs of the said parts of the Estate above the upper boundary of the Tai Wai Station including all the slabs above the water-proofing membrane and system and associated protection immediately above, all utilities, services, trenches, pits and facilities which serve the Estate, as well as all the finishes of the Estate, parts of the Setting-back Area, part of the 24-hour Walkway, parts of the Pedestrian Link, the Drainage Reserve or the New Drainage Reserve (as the case may be), the Waterworks Reserve, driveways, lifts, run in and out, the Public Lay-By, the PSC Lay-Bys, the Existing Public Toilet Items, the PSC Items, the PTI Items, cavity walls and diaphragm walls of the Basement Level 4 to the Basement Level 1, external walls, finishes and architectural features below the ceiling of 3rd Floor (excluding those parts of external walls forming parts of the Commercial Development and the finishes and architectural features thereof and thereat), external walls of the drum ramp above the ceiling level of 6th Floor up to the roof level, ramps, lift shafts, shuttle lifts, footpaths, staircases, landings, corridors and passages; pump rooms, transformer room, main switch room, electricity rooms, fire services control room, master meter cabinet and water meter room, fuel tank rooms, street fire hydrant and sprinkler and fire services pump room, fan rooms, sprinkler control valve room, pipe ducts, emergency generator rooms, air duct shaft, refuse storage and material recovery chamber; refuse collection point and spaces for the parking, loading and unloading of refuse collection vehicles provided pursuant to Special Condition No.(52)(b)(i) of the Government Grant; parapet walls, structural walls and columns, the foundations and other structural elements of the buildings erected on the Estate; management office, security room, guard rooms, caretaker’s quarters, office for Owners Committee and/or Owners Corporation, stores, lavatories and any other space on or in the Estate used for office of caretaker(s) or other accommodation of the Owners Committee or the Owners Corporation and all other communal areas within the Estate not used for the sole benefit of any Owner or group of Owners of the Estate (but excluding all parts of the Commercial Development, the Residential Common Areas, the Residential Car Park Common Areas, the B3 Commercial Car Park Common Areas and those areas forming parts of other common areas as designated or to be designated in the Sub-Deed of Mutual Covenant or Deed Poll to be executed by the First Owner pursuant to the Principal Deed of Mutual Covenant). The Estate Common Areas in Phase 1 and Phase 2 are for the purpose of identification only as shown (where possible and capable of being shown) coloured green, green hatched black and green cross-hatched black on the plans annexed to the Principal Deed of Mutual Covenant and as shown (where possible and capable of being shown) coloured green, green hatched black and green cross-hatched black (for those parts within Phase 1) and coloured green dash hatched red (for those parts within Phase 2) on the Common Areas demarcation plans annexed to the Principal Deed of Mutual Covenant. The Estate Common Areas in other Phase(s) shall be identified on plans to be annexed to any Sub-Deed of Mutual Covenant or Deed Poll to be executed in respect of such other Phases.

“Existing Footbridge” means the existing footbridge shown and marked as “**EXISTING FB**” on the plan annexed to the Government Grant together with all supports and connections as shall be required or approved by the Director in accordance with Special Condition No.(35)(a)(ii) of the Government Grant.

Information on public facilities and public open spaces

公共設施及公眾休憩用地的資料

"Existing Footbridge Supports, Connections and Extensions" means those supports, connections and extensions to the Existing Footbridge provided and constructed or to be provided and constructed in accordance with Special Condition No.(35)(a)(ii) of the Government Grant so that pedestrian and cyclist access can be gained over the Existing Footbridge to and from the Pedestrian Link;

Second Schedule, Part II

Clause 4(c). The public shall have the right at all times and during the existence of the Covered Footbridges and the Existing Footbridge Supports, Connections and Extensions for all lawful purposes freely and without payment of any nature whatsoever without any interruption to pass and repass on foot or by wheelchair or bicycle along, to, from, through, over, up and down the Covered Footbridges and the Existing Footbridge Supports, Connections and Extensions in accordance with Special Condition No.(35)(e)(iv) and (v) of the Government Grant.

Clause 5. There are reserved unto the Government, its officers, agents, contractors, workmen and other duly authorized personnel free of all costs and charges:

- (a) all necessary rights of ingress, egress and regress to and from the Land for the purposes of erecting, installing, repairing and maintaining street lightings, traffic signs, traffic signals and other forms of equipment on the external part or parts of the Existing Footbridge and within the Land which in the opinion of the Director (whose opinion is final and binding) are considered necessary for regulating vehicular and pedestrian traffic;
- (b) all necessary rights of ingress, egress and regress to and from the Land for the purposes of inspecting, checking, supervising, managing, keeping, repairing and maintaining the Existing Footbridge and carrying out site investigation and survey as necessary for its reconstruction and renovation; and
- (c) the right to connect the Existing Footbridge to the Existing Footbridge Supports, Connections and Extensions.

Third Schedule – Clause 1(ar)

Subject to the rights reserved to the First Owner in Clause 3 of Part II of the Second Schedule to the Principal Deed of Mutual Covenant, the rights easements and privileges reserved to FSI as the Owner of the Government Accommodation in the Principal Deed of Mutual Covenant and the Government Grant, the rights granted to and reserved by the Owner of the Tai Wai Station set out in Clause 3 of Part I of the Second Schedule to the Principal Deed of Mutual Covenant and the rights granted to and reserved by KCRC as Owner of the Tai Wai Station under the Station Assignment and the rights granted to the Owner(s) of the Commercial Development under Clause 6 of Part I of the Second Schedule to the Principal Deed of Mutual Covenant, an Owner shall not

...

Use or permit or suffer to be used by any part of the Covered Footbridges and the Existing Footbridge Supports, Connections and Extensions either externally or internally for advertising or for display of any signs, notices or posters whatsoever unless otherwise approval or required by the Director;

5. 24-hour Walkway

(I) Provisions under the land grant:

Special Condition No.(36)

- (d) (i) The Grantee shall at his own expense and in all respects to the satisfaction of the Director design, provide and thereafter manage and maintain within the lot and any building or buildings erected or to be erected thereon a pedestrian walkway which shall comprise such escalators, passenger lifts, staircases, ramps and other structures as shall be required or approved by the Director (which pedestrian walkway is hereinafter referred to as "**the 24-hour Walkway**") so as to link up the Tai Wai Station, the Existing Public Toilet, the Existing PTI, the New PTI, the Bicycle Park, the Cycle Track, the PSC, the Covered Footbridges, the Existing Footbridge, the PSC Lay-Bys referred to in Special Condition No. (49)(a) of the Land Grant, the Public Lay-By referred to in Special Condition No. (50)(a) of the Land Grant, the ground level of the lot and the footpaths at street level adjacent to the lot. The Grantee shall submit a plan indicating the routing of the 24-hour Walkway to the Director for approval. The decision of the Director as to what constitutes the ground level of the lot and the street level shall be final and binding upon the Grantee.
- (ii) The 24-hour Walkway (excluding the said escalators, passenger lifts, staircases, ramps and other structures) shall have a clear internal width of not less than 4.5 metres.
- (e) The Grantee shall throughout the term agreed to be granted by the Land Grant keep the 24-hour Walkway open for the use by the public 24 hours a day on foot or by wheelchair for all lawful purposes free of charge and without any interruption. The Grantee shall at his own expense keep the escalators and passenger lifts required to be provided under sub-clause (d)(i) of Special Condition No. (36) of the Land Grant in operation 24 hours a day to the satisfaction of the Director.

(II) Provisions under the principal deed of mutual covenant:

Section B – Definitions

"24-hour Walkway" means the pedestrian walkway comprising such escalators, passenger lifts, staircases, ramps and such other structures as shall be approved or required by the Director linking up the Tai Wai Station, the Government Accommodation, the Bicycle Park, the Cycle Track, the Covered Footbridges, the Existing Footbridge, the PSC Lay-Bys, the Public Lay-By, the ground level of the Land and the footpaths at street level adjacent to the Land as constructed and provided in accordance with Special Condition No.(36)(d)(i) of the Government Grant as for the purpose of identification only shown and coloured orange hatched black, green hatched black and indigo hatched black on the plans annexed to the Principal Deed of Mutual Covenant.

Information on public facilities and public open spaces

公共設施及公眾休憩用地的資料

"Commercial Development" means and includes those parts of the Estate constructed or to be constructed in accordance with the Approved Plans for commercial or retail use and including the external walls of the said parts of the Estate, the external walls of the Estate from the floor slab level of 4th Floor to the ceiling level of 6th Floor (whether or not the parts of Estate enclosed by such external walls form parts of the Commercial Development), (excluding those external walls forming parts of the PSC Items) the spaces provided pursuant to Special Condition No.(43)(b) of the Government Grant for parking of motor vehicles and motor cycles belonging to the occupiers of the Commercial Development and their bona-fide guests, visitors or invitees (including the B3 Commercial Car Parking Spaces), the loading and unloading spaces of goods vehicles provided pursuant to Special Condition No.(44)(a)(ii) of the Government Grant and designated for use by the Commercial Development, the associated driveway and circulation areas, staircases, (in the event that the said parts of the Estate is situated immediately above the Tai Wai Station) all the slabs of the said parts of the Estate above the upper boundary of the Tai Wai Station including all the slabs and finishes above the water-proofing membrane and system and associated protection immediately above, and all utilities, services, trenches, pits and facilities which serve the Commercial Development or any part thereof, as well as all the external finishes of the Commercial Development, part of the 24-hour Walkway, parts of the Pedestrian Link, all those parts of the Greenery Areas which serve the Commercial Development as a whole (which shall be designated as part of the Commercial Common Areas in the Sub-Deed of Mutual Covenant of the Commercial Development), the parapet wall of the podium, the Bicycle Park, the Cycle Track, the Covered Footbridges (whether within or outside the boundary of the Land) and the Existing Footbridge Supports, Connections and Extensions, but excluding those parts forming parts of the Residential Development, the Residential Car Park, the Government Accommodation, the Estate Common Areas, the Residential Common Areas, the Residential Car Park Common Areas and the B3 Commercial Car Park Common Areas, and for the purpose of identification only as shown (where possible and capable of being shown) coloured orange and orange hatched black on the floor plans annexed to the Principal Deed of Mutual Covenant.

"Estate Common Areas" means those parts of the Estate which are intended for use by Owners of the Estate as a whole and not for the sole benefit of any Owner or group of Owners of the Estate including, but not limited to all those parts of the Greenery Areas which serve the Estate as a whole, all the slabs of the said parts of the Estate above the upper boundary of the Tai Wai Station including all the slabs above the water-proofing membrane and system and associated protection immediately above, all utilities, services, trenches, pits and facilities which serve the Estate, as well as all the finishes of the Estate, parts of the Setting-back Area, part of the 24-hour Walkway, parts of the Pedestrian Link, the Drainage Reserve or the New Drainage Reserve (as the case may be), the Waterworks Reserve, driveways, lifts, run in and out, the Public Lay-By, the PSC Lay-Bys, the Existing Public Toilet Items, the PSC Items, the PTI Items, cavity walls and diaphragm walls of the Basement Level 4 to the Basement Level 1, external walls, finishes and architectural features below the ceiling of 3rd Floor (excluding those parts of external walls forming parts of the Commercial Development and the finishes and architectural features thereof and thereat), external walls of the drum ramp above the ceiling level of 6th Floor up to the roof level, ramps, lift shafts, shuttle lifts, footpaths, staircases, landings, corridors and passages; pump rooms, transformer room, main switch room, electricity rooms, fire services control room, master meter cabinet and water meter room, fuel tank rooms, street fire hydrant and sprinkler and fire services pump room, fan rooms, sprinkler control valve room, pipe ducts, emergency generator rooms, air duct shaft, refuse storage and material recovery chamber; refuse collection point and spaces for the parking, loading and unloading of refuse collection vehicles provided pursuant to Special Condition No.(52)(b)(i) of the Government Grant; parapet walls, structural walls and columns, the foundations and other structural elements of the buildings erected on the Estate; management office, security room, guard rooms, caretaker's quarters, office for Owners Committee and/or Owners Corporation, stores, lavatories and any other space on or in the Estate used for office of caretaker(s) or other accommodation of the Owners Committee or the Owners Corporation and all other communal areas within the Estate not used for the sole benefit of any Owner or group of Owners of the Estate (but excluding all parts of the Commercial Development, the Residential Common Areas, the Residential Car Park Common Areas, the B3 Commercial Car Park Common Areas and those areas forming parts of other common areas as designated or to be designated in the Sub-Deed of Mutual Covenant or Deed Poll to be executed by the First Owner pursuant to the Principal Deed of Mutual Covenant). The Estate Common Areas in Phase 1 and Phase 2 are for the purpose of identification only as shown (where possible and capable of being shown) coloured green, green hatched black and green cross-hatched black on the plans annexed to the Principal Deed of Mutual Covenant and as shown (where possible and capable of being shown) coloured green, green hatched black and green cross-hatched black (for those parts within Phase 1) and coloured green dash hatched red (for those parts within Phase 2) on the Common Areas demarcation plans annexed to the Principal Deed of Mutual Covenant. The Estate Common Areas in other Phase(s) shall be identified on plans to be annexed to any Sub-Deed of Mutual Covenant or Deed Poll to be executed in respect of such other Phases.

Information on public facilities and public open spaces 公共設施及公眾休憩用地的資料

Section E – Clause 26

- (a) The Owner of the Commercial Development shall throughout the Term at their own costs and expense keep such part of the 24-hour Walkway as is or may be constructed within the Commercial Development open for use by the public 24 hours a day on foot or by wheelchair for all lawful purposes free of charge and without any interruption in compliance with Special Condition No.(36)(e) of the Government Grant.
- (b) The Owners of the Estate (excluding FSI as the Owner of the Government Accommodation) shall throughout the Term at their own costs and expense keep such part of the 24-hour Walkway as is or may be constructed within the Estate Common Areas open for use by the public 24 hours a day on foot or by wheelchair for all lawful purposes free of charge and without any interruption in compliance with Special Condition No.(36)(e) of the Government Grant.

Second Schedule, Part II – Clause 4(b)

The public shall throughout the term of the Government Grant have the right to use the 24-hour Walkway 24 hours a day on foot or by wheelchair for all lawful purposes free of charge and without any interruption in accordance with Special Condition No.(36)(e) of the Government Grant.

6. PSC Lay-Bys

(I) Provisions under the land grant:

Special Condition No.(49)

- (a) The Grantee shall on or before 30th day of September, 2022 or within such time limit as may be specified and subject to such conditions as may be approved by the Director at his own expense and in all respects to the satisfaction of the Director provide and thereafter manage and maintain at the ground level of the lot (the decision of the Director as to what constitutes the ground level shall be final and binding on the Grantee) one lay-by measuring 3.5 metres in width and 11.0 metres in length with a minimum headroom of 4.7 metres and not less than one lay-by measuring 2.5 metres in width and 40 metres in aggregate length with a minimum headroom of 2.4 metres for the picking up and setting down of passengers from motor vehicles (including taxis) (collectively, "**the PSC Lay-Bys**") in connection with the PSC.
- (e) The PSC Lay-Bys provided within the lot in accordance with sub-clause (a) of Special Condition No. (49) of the Land Grant shall be designated as and form part of the Common Areas.
- (f) The Grantee shall throughout the term agreed to be granted by the Land Grant keep the PSC Lay-Bys open for use by the occupiers of the PSC and their bona fide guests, visitors or invitees 24 hours a day free of charge without any interruption to the satisfaction of the Director.

(II) Provisions under the principal deed of mutual covenant:

Section B – Definitions

"Estate Common Areas" means those parts of the Estate which are intended for use by Owners of the Estate as a whole and not for the sole benefit of any Owner or group of Owners of the Estate including, but not limited to all those parts of the Greenery Areas which serve the Estate as a whole, all the slabs of the said parts of the Estate above the upper boundary of the Tai Wai Station including all the slabs above the water-proofing membrane and system and associated protection immediately above, all utilities, services, trenches, pits and facilities which serve the Estate, as well as all the finishes of the Estate, parts of the Setting-back Area, part of the 24-hour Walkway, parts of the Pedestrian Link, the Drainage Reserve or the New Drainage Reserve (as the case may be), the Waterworks Reserve, driveways, lifts, run in and out, the Public Lay-By, the PSC Lay-Bys, the Existing Public Toilet Items, the PSC Items, the PTI Items, cavity walls and diaphragm walls of the Basement Level 4 to the Basement Level 1, external walls, finishes and architectural features below the ceiling of 3rd Floor (excluding those parts of external walls forming parts of the Commercial Development and the finishes and architectural features thereof and thereat), external walls of the drum ramp above the ceiling level of 6th Floor up to the roof level, ramps, lift shafts, shuttle lifts, footpaths, staircases, landings, corridors and passages; pump rooms, transformer room, main switch room, electricity rooms, fire services control room, master meter cabinet and water meter room, fuel tank rooms, street fire hydrant and sprinkler and fire services pump room, fan rooms, sprinkler control valve room, pipe ducts, emergency generator rooms, air duct shaft, refuse storage and material recovery chamber; refuse collection point and spaces for the parking, loading and unloading of refuse collection vehicles provided pursuant to Special Condition No.(52)(b)(i) of the Government Grant; parapet walls, structural walls and columns, the foundations and other structural elements of the buildings erected on the Estate; management office, security room, guard rooms, caretaker's quarters, office for Owners Committee and/or Owners Corporation, stores, lavatories and any other space on or in the Estate used for office of caretaker(s) or other accommodation of the Owners Committee or the Owners Corporation and all other communal areas within the Estate not used for the sole benefit of any Owner or group of Owners of the Estate (but excluding all parts of the Commercial Development, the Residential Common Areas, the Residential Car Park Common Areas, the B3 Commercial Car Park Common Areas and those areas forming parts of other common areas as designated or to be designated in the Sub-Deed of Mutual Covenant or Deed Poll to be executed by the First Owner pursuant to the Principal Deed of Mutual Covenant). The Estate Common Areas in Phase 1 and Phase 2 are for the purpose of identification only as shown (where possible and capable of being shown) coloured green, green hatched black and green cross-hatched black on the plans annexed to the Principal Deed of Mutual Covenant and as shown (where possible and capable of being shown) coloured green, green hatched black and green cross-hatched black (for those parts within Phase 1) and coloured green dash hatched red (for those parts within Phase 2) on the Common Areas demarcation plans annexed to the Principal Deed of Mutual Covenant. The Estate Common Areas in other Phase(s) shall be identified on plans to be annexed to any Sub-Deed of Mutual Covenant or Deed Poll to be executed in respect of such other Phases.

Information on public facilities and public open spaces

公共設施及公眾休憩用地的資料

"PSC Lay-Bys" means the lay-bys provided or to be provided at the ground level of the Land in all respects to the satisfaction of the Director for the picking up and setting down of passengers from motor vehicles (including taxis) in connection with the PSC in accordance with Special Condition No.(49)(a) of the Government Grant forming part of the Estate Common Areas and for the purpose of identification only as shown (where possible and capable of being shown) coloured green cross-hatched black on the Ground Floor Plan annexed to the Principal Deed of Mutual Covenant.

Second Schedule, Part II – Clause 4(g)

The occupiers of the PSC and their bona fide guests visitors or invitees shall throughout the term of the Government Grant has the right to use the PSC Lay-Bys 24 hours a day free of charge without any interruption in accordance with Special Condition No.(49)(f) of the Government Grant.

7. Public Lay-By

(I) Provisions under the land grant:

Special Condition No.(50)

- (a) The Grantee shall on or before 30th day of September, 2022 or within such time limit as may be specified and subject to such conditions as may be approved by the Director at his own expense and in all respects to the satisfaction of the Director provide and thereafter manage and maintain at the ground level of the lot near the junction between Chui Tin Street and Che Kung Miu Road or at such other location as may be determined by the Director (the decision of the Director as to what constitutes the ground level shall be final and binding on the Grantee) not less than one public lay-by measuring 3.5 metres in width and 40.0 metres in aggregate length for the picking up and setting down of passengers from motor vehicles (including taxis) ("**the Public Lay-By**"). The Grantee shall submit or cause to be submitted to the Commissioner for Transport detailed design proposal of the Public Lay-By for his written approval prior to commencement of building works.
- (e) The Public Lay-By provided within the lot in accordance with sub-clause (a) of Special Condition No. (50) of the Land Grant shall be designated as and form part of the Common Areas.
- (f) The Grantee shall throughout the term agreed to be granted by the Land Grant keep the Public Lay-By open for use by the public 24 hours a day free of charge without any interruption to the satisfaction of the Director.

(II) Provisions under the principal deed of mutual covenant:

Section B – Definitions

"Estate Common Areas" means those parts of the Estate which are intended for use by Owners of the Estate as a whole and not for the sole benefit of any Owner or group of Owners of the Estate including, but not limited to all those parts of the Greenery Areas which serve the Estate as a whole, all the slabs of the said parts of the Estate above the upper boundary of the Tai Wai Station including all the slabs above the water-proofing membrane and system and associated protection immediately above, all utilities, services, trenches, pits and facilities which serve the Estate, as well as all the finishes of the Estate, parts of the Setting-back Area, part of the 24-hour Walkway, parts of the Pedestrian Link, the Drainage Reserve or the New Drainage Reserve (as the case may be), the Waterworks Reserve, driveways, lifts, run in and out, the Public Lay-By, the PSC Lay-Bys, the Existing Public Toilet Items, the PSC Items, the PTI Items, cavity walls and diaphragm walls of the Basement Level 4 to the Basement Level 1, external walls, finishes and architectural features below the ceiling of 3rd Floor (excluding those parts of external walls forming parts of the Commercial Development and the finishes and architectural features thereof and thereat), external walls of the drum ramp above the ceiling level of 6th Floor up to the roof level, ramps, lift shafts, shuttle lifts, footpaths, staircases, landings, corridors and passages; pump rooms, transformer room, main switch room, electricity rooms, fire services control room, master meter cabinet and water meter room, fuel tank rooms, street fire hydrant and sprinkler and fire services pump room, fan rooms, sprinkler control valve room, pipe ducts, emergency generator rooms, air duct shaft, refuse storage and material recovery chamber; refuse collection point and spaces for the parking, loading and unloading of refuse collection vehicles provided pursuant to Special Condition No.(52)(b)(i) of the Government Grant; parapet walls, structural walls and columns, the foundations and other structural elements of the buildings erected on the Estate; management office, security room, guard rooms, caretaker's quarters, office for Owners Committee and/or Owners Corporation, stores, lavatories and any other space on or in the Estate used for office of caretaker(s) or other accommodation of the Owners Committee or the Owners Corporation and all other communal areas within the Estate not used for the sole benefit of any Owner or group of Owners of the Estate (but excluding all parts of the Commercial Development, the Residential Common Areas, the Residential Car Park Common Areas, the B3 Commercial Car Park Common Areas and those areas forming parts of other common areas as designated or to be designated in the Sub-Deed of Mutual Covenant or Deed Poll to be executed by the First Owner pursuant to the Principal Deed of Mutual Covenant). The Estate Common Areas in Phase 1 and Phase 2 are for the purpose of identification only as shown (where possible and capable of being shown) coloured green, green hatched black and green cross-hatched black on the plans annexed to the Principal Deed of Mutual Covenant and as shown (where possible and capable of being shown) coloured green, green hatched black and green cross-hatched black (for those parts within Phase 1) and coloured green dash hatched red (for those parts within Phase 2) on the Common Areas demarcation plans annexed to the Principal Deed of Mutual Covenant. The Estate Common Areas in other Phase(s) shall be identified on plans to be annexed to any Sub-Deed of Mutual Covenant or Deed Poll to be executed in respect of such other Phases.

Information on public facilities and public open spaces

公共設施及公眾休憩用地的資料

"Public Lay-By" means the public lay-by provided or to be provided at the ground level of the Land near the junction between Chui Tin Street and Che Kung Miu Road (or at such other location as may be determined by the Director) in all respects to the satisfaction of the Director for the picking up and setting down of passengers from motor vehicles (including taxis) in accordance with Special Condition No.(50)(a) of the Government Grant forming part of the Estate Common Areas;

Second Schedule, Part II – Clause 4(h)

The public shall throughout the term of the Government Grant has the right to use the Public Lay-By 24 hours a day free of charge without any interruption in accordance with Special Condition No.(50)(f) of the Government Grant.

8. Setting-back Area

(I) Provisions under the land grant:

Special Condition No.(62)

- (a) Subject to Special Condition No. (60) of the Land Grant, except with the prior written consent of the Director, no building or structure or support for any building or structure shall be erected or constructed or placed, and no object or material of whatsoever nature shall be stored or placed on, over or above the ground level of those parts of the lot shown coloured pink hatched black and pink cross-hatched black stippled red hatched black on the plan annexed to the Land Grant (collectively, "**the Setting-back Area**").
- (b) Notwithstanding the provision in sub-clause (a) of Special Condition No. (62) of the Land Grant, the Grantee may erect or allow to be erected on the Setting-back Area such landscaping and recreational facilities, canopies, covered walkway, other structures as shown on the Approved Landscape Master Plan or any master layout plan or plans approved by the Town Planning Board and such other structures or facilities as may be approved in writing by the Director.
- (d) The Grantee shall throughout the term agreed to be granted by the Land Grant keep the Setting-back Area open for use by the public for all lawful purposes 24 hours a day free of charge without any interruption to the satisfaction of the Director.
- (h) Throughout the term agreed to be granted by the Land Grant the Grantee shall at his own expense manage and maintain the Setting-back Area and all the structures and facilities erected or to be erected thereon in accordance with sub-clause (b) of Special Condition No. (62) of the Land Grant in good and substantial repair and condition in all respects to the satisfaction of the Director.

(II) Provisions under the principal deed of mutual covenant:

Section B – Definitions

"Estate Common Areas" means those parts of the Estate which are intended for use by Owners of the Estate as a whole and not for the sole benefit of any Owner or group of Owners of the Estate including, but not limited to all those parts of the Greenery Areas which serve the Estate as a whole, all the slabs of the said parts of the Estate above the upper boundary of the Tai Wai Station including all the slabs above the water-proofing membrane and system and associated protection immediately above, all utilities, services, trenches, pits and facilities which serve the Estate, as well as all the finishes of the Estate, parts of the Setting-back Area, part of the 24-hour Walkway, parts of the Pedestrian Link, the Drainage Reserve or the New Drainage Reserve (as the case may be), the Waterworks Reserve, driveways, lifts, run in and out, the Public Lay-By, the PSC Lay-Bys, the Existing Public Toilet Items, the PSC Items, the PTI Items, cavity walls and diaphragm walls of the Basement Level 4 to the Basement Level 1, external walls, finishes and architectural features below the ceiling of 3rd Floor (excluding those parts of external walls forming parts of the Commercial Development and the finishes and architectural features thereof and thereat), external walls of the drum ramp above the ceiling level of 6th Floor up to the roof level, ramps, lift shafts, shuttle lifts, footpaths, staircases, landings, corridors and passages; pump rooms, transformer room, main switch room, electricity rooms, fire services control room, master meter cabinet and water meter room, fuel tank rooms, street fire hydrant and sprinkler and fire services pump room, fan rooms, sprinkler control valve room, pipe ducts, emergency generator rooms, air duct shaft, refuse storage and material recovery chamber; refuse collection point and spaces for the parking, loading and unloading of refuse collection vehicles provided pursuant to Special Condition No.(52)(b)(i) of the Government Grant; parapet walls, structural walls and columns, the foundations and other structural elements of the buildings erected on the Estate; management office, security room, guard rooms, caretaker's quarters, office for Owners Committee and/or Owners Corporation, stores, lavatories and any other space on or in the Estate used for office of caretaker(s) or other accommodation of the Owners Committee or the Owners Corporation and all other communal areas within the Estate not used for the sole benefit of any Owner or group of Owners of the Estate (but excluding all parts of the Commercial Development, the Residential Common Areas, the Residential Car Park Common Areas, the B3 Commercial Car Park Common Areas and those areas forming parts of other common areas as designated or to be designated in the Sub-Deed of Mutual Covenant or Deed Poll to be executed by the First Owner pursuant to the Principal Deed of Mutual Covenant). The Estate Common Areas in Phase 1 and Phase 2 are for the purpose of identification only as shown (where possible and capable of being shown) coloured green, green hatched black and green cross-hatched black on the plans annexed to the Principal Deed of Mutual Covenant and as shown (where possible and capable of being shown) coloured green, green hatched black and green cross-hatched black (for those parts within Phase 1) and coloured green dash hatched red (for those parts within Phase 2) on the Common Areas demarcation plans annexed to the Principal Deed of Mutual Covenant. The Estate Common Areas in other Phase(s) shall be identified on plans to be annexed to any Sub-Deed of Mutual Covenant or Deed Poll to be executed in respect of such other Phases.

Information on public facilities and public open spaces

公共設施及公眾休憩用地的資料

"Setting-back Area" means those areas shown coloured pink hatched black and pink cross-hatched black stippled red hatched black on the plan annexed to the Government Grant as referred to under Special Condition No.(62)(a) of the Government Grant;

Second Schedule, Part II – Clause 4(d)

The public shall throughout the term of the Government Grant have the right to use the Setting-back Area 24 hours a day for all lawful purposes free of charge and without any interruption in accordance with Special Condition No.(62)(d) of the Government Grant.

C. Any open space that is required under the land grant to be managed, operated or maintained for public use at the expense of the owners of the residential properties in the development

Not applicable

D. Any part of the land (on which the development is situated) that is dedicated to the public for the purposes of regulation 22(1) of the Building (Planning) Regulations (Cap. 123 sub. Leg. F)

Not applicable

Information on public facilities and public open spaces

公共設施及公眾休憩用地的資料

A. 根據批地文件規定需要搭建並為政府，或供公眾使用的設施

1. 綠色區域及構築物

(I) 批地文件的條文

特別條款第(5)(a)條

承批人須：

- (i) 於2022年9月30日或在署長可能批准的其他日期或之前，自費並按署長批准的方式、物料、標準、水平、定線和設計進行下述工程，並在各方面使署長滿意：
 - (I) 在批地文件所夾附的圖則上以綠色顯示的部分（「綠色區域」）鋪設及興建部分未來公共道路；及
 - (II) 提供及建造該等橋樑、隧道、上跨路、下通道、下水道、高架道路、天橋、行人道、道路或署長自行酌情要求的其他構築物（「該等構築物」）；

使綠色區域內的建築、車輛、行人及單車的交通往來；

- (ii) 於2022年9月30日或在署長可能批准的其他日期或之前，自費在綠色區域鋪設路面、建造路緣及開水道，並提供署長規定的溝渠、污水渠、排水渠、消防栓連接駁至總水管的水管、街燈、交通標誌、街道設施、路面標記及植物，以達至署長滿意程度；及
- (iii) 自費保養綠色區域連同該等構築物及在該區域之上或之內建造、安裝及提供的該等構築物、表面、溝渠、污水渠、排水渠、消防栓連接駁至總水管的水管、服務設施、街燈、交通標誌、街道設施、路面標記和植物，以達至署長滿意程度及直至綠色區域已根據批地文件特別條款第(6)條交回政府管有為止。

特別條款第(6)條

僅為了進行批地文件特別條款第(5)條指明的必要工程，綠色區域的管有權將會在批地文件訂立之日批予承批人。綠色區域或任何部分須於政府要求時交還給政府，而在任何情況下，承批人在署長發信表示此等條款已符合並使其滿意之日便當作已交還給政府。承批人須於所有合理時間在其管有綠色區域或任何部分期間，准許所有政府及公共車輛、行人及單車使用者自由進入、通過及經過綠色區域或其中部分，並確保該項進入的權利不受進行的工程干擾或阻礙，不論是按照批地文件的特別條款第(5)條或其他規定進行的工程。

特別條款第(7)條

承批人未獲得署長事先書面同意不可在綠色區域儲物或在該處搭建任何臨時構築物，或用作進行批地文件特別條款第(5)條指明的工程以外的其他用途。

特別條款第(8)(a)條

承批人須在管有綠色區域期間，於所有合理時間內：

- (i) 准許政府、署長及其官員、承辦商與代理人及署長授權的任何其他人士有權自由及不受限制出入、經過及往返該地段及綠色區域或其中部分，旨在視察、檢查及監管批地文件的特別條款第(5)(a)條指定的工程及監管批地文件的特別條款第(5)(b)條的工程及署長認為有必要在綠色區域或其中部分進行的任何其他工程；
- (ii) 在政府和政府授權的有關公用事業公司要求時准許其有權自由及不受限制出入、經過及往返該地段及綠色區域或其中部分，旨在綠色區域或其中部分或任何毗鄰土地之內、之上或之下進行任何工程，包括但不限於鋪設和其後保養一切管道、電線、導管、電纜槽及其他傳導媒介及輔助設備，以便提供電話、電力、氣體(如有)及其他服務給該地段或任何毗鄰或毗連土地及建築。承批人須充分配合政府及政府正式授權的有關公用事業公司在綠色區域或其中部分內進行上述工程的一切事宜；及
- (iii) 在水務監督的官員及其授權的其他人士要求時准許其有權自由及不受限制出入、經過及往返該地段及綠色區域或其中部分，旨在進行有關操作、保養、修理、更換、更改綠色區域或其中部分內的任何其他水務工程裝置。

(II) 主公契的條文

B章 一定義

「綠色區域」指批地文件特別條件第(5)(a)(i)(I)條提述在批地文件所夾附的圖則上以綠色顯示的部分未來公共道路；

「構築物」批地文件特別條件第(5)(a)(i)(II)條定義的構築物；

「其他構築物及設施」指根據批地文件特別條件第(5)(a)(iii)條在綠色區域之上或之內建造、安裝及提供的所有構築物、表面、溝渠、污水渠、排水渠、消防栓、服務設施、街燈、交通標誌、街道設施、路面標記和植物，使署長滿意。

E章 第18條

18. (a) 業主(大圍站業主和擔任政府樓宇業主的財政司司長法團除外)須自費保養綠色區域連同該等構築物及根據批地文件特別條件第(5)(a)(iii)條提供的其他構築物及設施直至綠色區域已根據批地文件特別條件第(6)條交回政府管有為止。
- (b) 承批人須於所有合理時間在其管有綠色區域或任何部分，允許所有政府及公共車輛、行人及單車使用者自由進入、通過及經過綠色區域或其中部分，並確保該項進入的權利不受進行的工程干擾或阻礙，不論是按照批地文件特別條件第(5)條或其他規定進行的工程。
- (c) 承批人須於所有合理時間在其管有綠色區域或任何部分，允許署長、及其人員、承辦商、代理及其他獲署長授權人士、政府及獲政府授權的相關公共事業公司、水務監督之人員及他們授權之人士有權出入及經過該土地及綠色區域或其中部分，以便進行、視察、檢查及監督根據批地文件特別條件第(8)(a)條進行的工程。

Information on public facilities and public open spaces

公共設施及公眾休憩用地的資料

I章 — 第1(b)(xvi)條

茲毋損前文之一般規定，管理人將具有以下各項權力及職責：

...

允許署長、及其人員、承辦商、代理及其他獲署長授權人士、政府及獲政府授權的相關公共事業公司、水務監督之人員及他們授權之人士有權出入、經過及再經過該土地及綠色區域，以便進行、視察、檢查及監督根據批地文件特別條件第(8)(a)條進行的工程。

J章 — 第2(a)(i)條

管理人須設立及保持由下列獨立賬戶所組成的一個特別基金：

...

設立一個屋苑特別基金賬戶，用作支付有關現有公廁項目、專上學院項目及主公契E章第10條規定業主(擔任政府樓宇業主的財政司司長法團除外)負責的公共運輸交匯處項目、斜坡及護土構築物、預製地樁(如有)、綠色區域、構築物及其他構築物及設施、屋苑公用地方及/或屋苑公用服務及設施的資本性質的主要工程或並非預期每年支出的開支，包括但不限於修復、改善及維修有公廁項目、專上學院項目及公共運輸交匯處項目、斜坡及護土構築物、預製地樁(如有)、綠色區域、構築物及其他構築物及設施、屋苑公用地方及/或屋苑公用服務及設施的開支，購買、設置、更換、改善及增加屋苑公用地方及/或屋苑公用服務及設施的開支和有關勘測工程及專業服務的費用。

J章 — 第4(i)(i)條

(i) 管理人須編製下列預算：

- (i) 一份屋苑管理預算，列明管理與保養現有公廁項目、專上學院項目及主公契E章第10條規定業主(擔任政府樓宇業主的財政司司長法團除外)負責的公共運輸交匯處項目、斜坡及護土構築物、預製地樁(如有)、綠色區域、構築物及其他構築物及設施、屋苑公用地方及屋苑公用服務及設施的預計開支，包括屋苑特別基金賬戶的供款和管理人酬金的一個適當部分，但不包括歸屬住宅發展項目、商業發展項目或住宅停車位的開支。

2. 現有公廁

(I) 批地文件的條文

特別條款第(16)條

(a) 承批人確認目前在該地段的地面建有一個淨作業樓面面積不少於71.3平方米的公廁(該樓宇包括照明裝置、通風設備、抽氣管道及道路或地板表面，但不包括升降機、扶手電梯、樓梯、機械、設備及署長按此等條款可批准並非專供該地方的其他設施包括牆壁、支柱、橫樑、天花板、天台板、軌道、樓板及任何其他的結構件)連同署長可全權酌情決定(其決定為最終決定並對承批人有約束力)專供該地方的任何其他區域、設施、服務及裝置，在下文稱為「現有公廁」。政府對現有公廁的存在、運作及使用造成承批人或使其蒙受的任何損失、損害、滋擾或干擾毋須承擔任何責任。

(c) 政府特此保留權利並可全權酌情在任何時候更改或改變現有公廁或其中任何部分。

(e) (i) 承批人須於批地文件約定的批租年期內的任何時候准許一切公眾人士為了合法目的的自由及免付任何性質的費用進入、經過承批人指定的該地段的一個或多個部分和在其之上的任何建築物、構築物及搭建物之內、之下、之上或上面，以便不受阻礙出入現有公廁和毗鄰公共道路並使食物環境衛生署署長滿意。

(g) 當承批人按批地文件特別條款第(3)條獲取該地段的管有權時，應當作為承批人交付現有公廁的管有權給政府，專供其使用、佔用及運作。

(II) 主公契的條文

B章 — 定義

「現有公廁」指批地文件特別條件第(16)(a)條提述在沙田市地段第520號(「該土地」)的地面的現有公廁(包括照明裝置、通風設備、抽氣管道及道路或地板表面，但不包括升降機、扶手電梯、樓梯、機械、設備及署長按批地文件可批准並非專供該地方的其他設施、牆壁、支柱、橫樑、天花板、天台板、軌道、樓板及任何其他的結構件)連同署長可全權酌情決定專供該地方的任何其他區域、設施、服務及裝置，上述現有公廁(如果可以在圖則上予以識別和顯示)於主公契所夾附的地面圖則上以粉紅色顯示，僅作識別之用。

「政府樓宇」指現有公廁、新的公共運輸交匯處及專上學院，為免存疑，不包括專上學院的外部飾面及正面和專上學院之中、之內、周圍、內部、之上及之下的一切牆壁、支柱、橫樑、天花板、天台板、軌道或樓板的結構及任何其他結構件。

Information on public facilities and public open spaces

公共設施及公眾休憩用地的資料

3. 現有公共運輸交匯處

(I) 批地文件的條文

特別條款第(17)條

- (a) 承批人確認目前在該地段的地面設有一個公共運輸交匯處(該樓宇(包括照明裝置、通風設備、抽氣管道及道路或地板表面，但不包括升降機、扶手電梯、樓梯、機械、設備及署長按此等條款可批准並非專供服務該地方的其他設施包括牆壁、支柱、橫樑、天花板、天台板、軌道、樓板及任何其他的結構件)連同署長可全權酌情決定(其決定為最終決定並對承批人有約束力)專供服務該地方的任何其他區域、設施、服務及裝置，在下文稱為「**現有公共運輸交匯處**」)。政府對現有公共運輸交匯處的存在、運作及使用造成承批人或使其蒙受的任何損失、損害、滋擾或干擾毋須承擔任何責任。承批人須對承批人、他的僱工、工人及承辦商在現有公共運輸交匯處作出或不作出的任何事情所直接或間接產生或有關的一切責任、索償、費用、要求、訴訟及其他司法程序彌償政府並保證其獲得彌償。
- (b) 當承批人按批地文件特別條款第(3)條獲取該地段的管有權時，應當作為承批人交付現有公共運輸交匯處的管有權給政府，專供其使用、佔用及運作，但是不影響政府與承批人就保養現有公共運輸交匯處所達成的任何協議，直至按批地文件特別條款第(17)(g)條交還現有公共運輸交匯處的管有權給承批人。
- (c) 承批人須准許公眾使用現有公共運輸交匯處和不能干涉現有公共運輸交匯處的正常運作。未經取得運輸署署長的事先書面批准，不准進行可能影響現有公共運輸交匯處的正常運作之任何建築工程。
- (e) 政府在管有現有公共運輸交匯處期間具有絕對酌情權於任何時候決定公眾使用現有公共運輸交匯處或其中任何部分之事宜。
- (f) (i) 承批人須允許政府和公共車輛及行人通過該地段或其中任何部分，以便出入現有公共運輸交匯處。政府具有絕對權利按《道路交通條例》、《公共巴士服務條例》、其下的任何規例及任何修訂法例行使其權力。
- (g) 應署長要求，緊接在按批地文件特別條款第(18)(1)條交付新的公共運輸交匯處(按批地文件特別條款第(18)(a)(i)條定義)的空置管有權給政府或按批地文件特別條款第(18)(i)條轉讓新的公共運輸交匯處給財政司司長法團之前，以較早者為準，應視為交還現有公共運輸交匯處的管有權給承批人。

(II) 主公契的條文

B章 一定義

「現有公共運輸交匯處」指批地文件特別條款第(17)(a)條提述當時在該土地的地面的現有公共運輸交匯處(包括照明裝置、通風設備、抽氣管道及道路或地板表面，但不包括升降機、扶手電梯、樓梯、機械、設備及署長按此等條件可批准並非專供服務該地方的其他設施、牆壁、支柱、橫樑、天花板、天台板、軌道、樓板及任何其他的結構件)連同署長可全權酌情決定專供服務該地方的任何其他區域、設施、服務及裝置。

4. 新的公共運輸交匯處

(I) 批地文件的條文

特別條款第(18)條

- (a) (i) 承批人須按此等條款及按批地文件特別條款第(18)(d)條批准的圖則以精工細作的方式在或將在該地段的地面上自費設計、搭建、建造及提供(包括對現有公共運輸交匯處進行一切必要的工程及更改工程和運輸署署長認為必要的其他工程)一個公共運輸交匯處，包括一個配有7條鋸齒形巴士停車灣的巴士總站、1個平行巴士停車灣及6個平行巴士輪候車位、4個平行綠色專線小巴停車灣、1個平行普通上落客貨區、2個公共上落客貨區及1個的士候客區或運輸署署長可要求或批准的其他數量或設施，並保留一個淨作業樓面面積不少於45平方米的區域放置巴士營運者的輔助設施，並設有通道連接公用道路和提供輔助設施。上述項目須於2022年9月30日或之前或署長可決定(其決定為最終決定並對承批人有約束力)的較遲日期完成並使其適合佔用及運作及在一切方面使署長滿意，(該樓宇(包括照明裝置、通風設備、抽氣管道及道路或地的表面，但不包括升降機、扶手電梯、樓梯、機械、設備及署長按此等條款可批准並非專供該地方的其他設施、牆壁、支柱、橫樑、天花板、天台板、軌道、樓板及任何其他的結構件)連同署長可全權酌情決定(其決定為最終決定並對承批人有約束力)專供該地方的任何其他區域、設施、服務及裝置)，在下文稱為「**新的公共運輸交匯處**」)。
- (b) 政府特此保留權利可在任何時候有絕對酌情權更改或改變新的公共運輸交匯處或其中任何部分的用途。

(II) 主公契的條文

B章 一定義

「新的公共運輸交匯處」指按批地文件特別條款第(18)(a)(i)條在該土地的地面上已經或將會建造的公共運輸交匯處，包括一個配有7條鋸齒形巴士停車灣的巴士總站、1個平行巴士停車灣及6個平行巴士輪候車位、4個平行綠色專線小巴停車灣、1個平行普通上落客貨區、2個公共上落客貨區及1個的士候客區或運輸署署長可要求或批准的其他數量或設施，並保留一個淨作業樓面面積不少於45平方米的區域放置巴士營運者的輔助設施，並設有通道連接公用道路和提供輔助設施，(包括照明裝置、通風設備、抽氣管道及道路或地板表面，但不包括升降機、扶手電梯、樓梯、機械、設備及署長按批地文件可批准並非專供該地方的其他設施、牆壁、支柱、橫樑、天花板、天台板、軌道、樓板及任何其他的結構件)連同署長可全權酌情決定專供該地方的任何其他區域、設施、服務及裝置)，上述新的公共運輸交匯處(如果可以在圖則上予以識別和顯示)於主公契所夾附的平面圖則上以靛藍色和靛藍色間黑斜線顯示，僅作識別之用。

「政府樓宇」指現有公廁、新的公共運輸交匯處及專上學院，為免存疑，不包括專上學院的外部飾面及正面和專上學院之中、之內、周圍、內部、之上及之下的一切牆壁、支柱、橫樑、天花板、天台板、軌道或樓板的結構及任何其他結構件。

Information on public facilities and public open spaces

公共設施及公眾休憩用地的資料

5. 單車停車場及單車徑

(I) 批地文件的條文

特別條款第(20)條

- (a) 承批人須在2022年9月30日或之前或署長可指定的期限內按署長可批准的條件在新的公共運輸交匯處附近的位置或署長可決定的其他位置自費以精工細作的方式搭建與建造和其後保養與管理一個單車停車場(「單車停車場」)，其範圍涵蓋330個停車位或署長可批准的其他數目，供公眾停泊單車。承批人須在展開工程之前提交或促使他人提交詳細的設計建議給運輸署長作書面批核。
- (c) 承批人須於批地文件約定的批租年期內，保持單車停車場每日24小時開放給公眾使用，除臨時關閉單車停車場或其中任何部分以便進行保養工程。

特別條款第(21)條

- (a) 承批人須在2022年9月30日或之前或署長可指定的期限內按署長可批准的條件自費提供和其後保養與管理一條淨寬度不少於3.5米的單車徑(「單車徑」)，以便銜接單車停車場和毗鄰的單車徑，確保延續沙田新市鎮的單車徑網絡。
- (e) 承批人須於批地文件約定的批租年期內，保持單車徑每日24小時開放給單車使用者(不論是否騎著單車)不受阻礙地經過及再經過單車徑。

(II) 主公契的條文

B章 — 定義

「單車停車場」指按批地文件特別條款第(20)(a)條已經或將會建造和其後保養與管理供公眾停泊單車的單車停車場，構成商業發展項目之部分，在一切方面使署長滿意。

「單車徑」指按批地文件特別條款第(21)條已經或將會提供和其後保養與管理的單車徑，構成商業發展項目之部分，以便銜接單車停車場和毗鄰的單車徑，確保延續沙田新市鎮的單車徑網絡，在一切方面使署長滿意。

「商業發展項目」指及包括按經批准圖則已建或擬建用作商業或零售用途的屋苑該等部分及包括屋苑該等部分的外牆、屋苑由4樓樓板水平至6樓天花水平的外牆(不論由該等外牆所圍封的屋苑部分是否構成商業發展項目的部分)(不包括構成專上學院項目一部分的外牆)、按批地文件特別條款第(43)(b)條提供作停泊屬於商業發展項目的佔用人和他們的真正賓客、訪客或獲邀請者的汽車及電單車的停車位(包括B3商業停車位)、按批地文件特別條款第(44)(a)(ii)條提供並指定給商業發展項目使用的上落貨車停車位、輔助行車道及迴旋處、樓梯、(若屋苑該等部分緊貼大圍站之上)在大圍站上層邊界上面屋苑部分的所有樓板，包括防水膜上面的所有樓板及飾面及其上面的系統及輔助保護裝置、供商業發展項目或其中任何部分的一切公用事業、服務、溝渠及設施、商業發展項目的所有外部飾面、部分24小時行人道、部分行人通道、供整個商業發展項目的綠化地帶之所有部分(將在商業發展項目的分公契內指定為商業公用地方之部分)、平台護牆、單車停車場、單車徑、有蓋行人天橋(不論是該土地邊界以內或以外)及現有行人天橋的支撐物、連接物及延伸物，但不包括屬於住宅發展項目、住宅停車場、政府樓宇、屋苑公用地方、住宅公用地方、住宅停車場公用地方及B3商業停車場公用地方之部分，上述商業發展項目(如果可以在圖則上予以識別和顯示)於主公契所夾附的平面圖則上以橙色和橙色間黑斜線顯示，僅作識別之用。

附表二第II部分 — 第4條

- (e) 公眾人士有權於批地文件約定的批租年期內每日24小時使用單車停車場，除臨時關閉單車停車場或其中任何部分以便進行批地文件特別條款第(20)(c)條規定的保養工程。
- (f) 批地文件特別條款第(21)(e)條規定，於批地文件約定的批租年期內必須保持單車徑每日24小時開放給單車使用者(不論是否騎著單車)免費及不受阻礙地經過及再經過單車徑。

6. 專上學院、專上學院停車處、專上學院避車處

(I) 批地文件的條文

特別條款第(22)條

- (a) (i) 承批人須按批地文件特別條款第(22)(c)條規定和教育局局長與承批人協定的規格(「規格」)在該地段內自費以精工細作的方式設計、搭建、建造及提供一個總樓面面積為15,000平方米的專上學院連同批地文件特別條款第(43)(c)和(43)(e)(i)(III)條規定的8個車輛停車位和5個電單車停車位(統稱「專上學院」)，在一切方面使教育局局長滿意。
- (ii) 承批人須在2020年3月31日或之前或教育局局長與承批人協定的較遲日期完成專上學院的結構外殼及外正面連同8個車輛停車位和5個電單車停車位。
- (iii) 即使批地文件特別條款第(22)(a)(i)條規定，如果承批人未能在批地文件之日起36個曆月內與教育局局長就規格達成協議，承批人須立即在批地文件特別條款第(22)(a)(ii)條指定的期限或之前按教育局局長已批准或擬批准的設計及平面圖(包括其後任何修訂)在該地段內以精工細作的方式建造與提供專上學院，在一切方面使教育局局長滿意。
- (iv) 承批人須自費保養及管理專上學院及在其中、其內及其下的所有物件，使其保持良好狀態及達至署長滿意程度，直至專上學院已根據批地文件特別條款第(22)(m)條交回政府管有或根據批地文件特別條款第(22)(h)條轉讓予財政司司長法團(以較早者為準)為止。

Information on public facilities and public open spaces

公共設施及公眾休憩用地的資料

(b) 政府特此保留權利在任何時候有絕對酌情權更改或改變專上學院或其中任何部分的用途。

特別條款第(43)條

(c) 必須在該地段內提供8個停車位並使署長滿意，用作停泊《道路交通條例》、該條例下任何規例及任何修訂法例獲發許可並屬於專上學院的佔用人和他們真正的來賓、訪客或被邀請者的車輛的用途。該等停車位不能用作儲存、展示或陳列車輛作出售或其他用途或汽車清潔及美容服務。

特別條款第(49)條

(a) 承批人須在2022年9月30日或之前或署長可指定的其他期限按署長可批准的條件在該地段的地面水平(署長就甚麼構成該地段的地面水平和街道水平的決定是最終決定並對承批人有約束力)提供和其後管理與保養1個尺寸為3.5米寬、11.0米長、最低淨空高度為4.7米的停車處和不少於1個尺寸為2.5米寬、40米總長、最低淨空高度為2.4米的停車處，供與專上學院有關的車輛(包括的士)上落客之用(統稱為「專上學院停車處」)。

(e) 根據批地文件特別條款第(49)(a)條於該地段內提供的專上學院停車處須指定為及構成公用地方之一部分。

(f) 承批人須於批地文件約定的批租年期內並保持專上學院停車處開放給專上學院的佔用人和他們的真正來賓、訪客或被邀請者每日24小時免費不受阻礙地使用並使署長滿意。

(II) 主公契的條文

B章 一定義

「屋苑公用地方」指其用途為供整個屋苑使用，而並非屋苑的任何個別業主或若干業主獨家享用的屋苑該等部分，包括但不限於供整個屋苑的綠化地帶的所有該等部分、在大圍站上層邊界上面屋苑部分的所有樓板，包括防水膜上面的所有樓板及其上面的系統及輔助保護裝置、供屋苑的一切公用事業、服務、溝渠及設施、屋苑的所有飾面、部分後移範圍、部分24小時行人道、部分行人通道、渠務專用範圍或新渠務專用範圍(視情況而定)、水務工程專用範圍、行車道、升降機、入口及出口、公共停車處、專上學院停車處、現有公廁項目、專上學院項目、公共運輸交匯處項目、地庫4樓至地庫1樓之空心牆及地下連接牆、3樓天花以下之外牆、飾面及建築裝飾(不包括該等構成商業發展項目的外牆部分及其飾面及建築裝飾)、6樓天花以上至天台之滾筒斜道之外牆、斜道、升降機槽、穿梭升降機、行人徑、樓梯、梯台、走廊及通道；泵房、變壓器房、主電掣房、電力房、消防控制室、主儀錶櫃及水錶房、燃料箱房、街道消防栓及花灑和消防泵房、風機房、花灑控制室、管槽、緊急發電機房、通風槽、垃圾存放及物料回收房、垃圾收集站和按批地文件特別條件第(52)(b)(i)條提供的垃圾車停泊、上落貨用的停車位；護牆、結構牆及支柱、地基及屋苑上的建築物的其他結構件；管理處、保安員室、警衛室、管理員櫃位、業主委員會及/或業主立案法團辦事處、儲物室、洗手間和屋苑之上或之內用作管理員辦事處的其他區域或業主委員會或業主立案法團的其他樓宇和該屋苑內並非供屋苑任何個別業主或若干業主獨家享用的一切其他公用地方(但不包括商業發展項目、住宅公用地方、住宅停車場公用地方、B3商業停車場公用地方及第一業主控主公契訂立的公契或平邊契據指定或將指定為公用地方的該等區域)。第1期和第2期的屋苑公用地方(如果可以在圖則上予以識別和顯示)於主公契所夾附的圖則上以綠色、綠色間黑斜線、綠色間黑交叉線顯示，及於主公契所夾附的公用地方劃分圖上以綠色、綠色間黑斜線及綠色間黑交叉線(就第1期內的部分而言)及綠色間紅色虛線(就第2期內的部分而言)顯示，僅作識別之用。其他期數的屋苑公用地方將在有關期數的任何分公契或平邊契據所夾附的圖則上標明。

「政府樓宇」指現有公廁、新的公共運輸交匯處及專上學院，為免存疑，不包括專上學院的外部飾面及正面和專上學院之中、之內、周圍、內部、之上及之下的一切牆壁、支柱、橫樑、天花板、天台板、軌道或樓板的結構及任何其他結構件。

「專上學院」指按批地文件特別條件第22(a)條已經或將會建造的專上學院連同專上學院停車位，在一切方面使教育局局長滿意，上述專上學院(如果可以在圖則上予以識別和顯示)於主公契所夾附的平面圖則上以紫色顯示，僅作識別之用。

「專上學院停車處」指按批地文件特別條件第(49)(a)條在該土地的地面上已經或將會提供的專上學院停車處，構成屋苑公用地方之部分，供與專上學院有關的車輛(包括的士)上落客之用，在一切方面使署長滿意，上述專上學院停車處(如果可以在圖則上予以識別和顯示)於主公契所夾附的地面圖則上以綠色間黑交叉線顯示，僅作識別之用。

「專上學院停車位」指按批地文件特別條件第22(a)條已經或將會建造的8個車輛停車位和5個電單車停車位，構成專上學院之部分，在一切方面使教育局局長滿意。

Information on public facilities and public open spaces

公共設施及公眾休憩用地的資料

附表二第II部分 — 第4(g)條

批地文件特別條件第(49)(f)條規定，專上學院的佔用人和他們的真正來賓、訪客或獲邀請者有權於批地文件約定的批租年期內每日24小時免費及不受阻礙地使用專上學院停車處。

7. 有蓋行人天橋、現有天橋、現有行人天橋的支撐物、連接物及延伸物

(i) 批地文件的條文

特別條款第(35)條

(a) 承批人須在2022年9月30日或之前或署長可指定的期限內按署長批准的條件自費建造下列項目，在一切方面使署長滿意：

- (i) 在批地文件所夾附的圖則上顯示與註明“**PROPOSED FB 1**”和“**PROPOSED FB 2**”的大約位置搭建、建造及提供署長要求或批准的2座單層有蓋行人天橋連同其一切支撐物及連接段(包括署長有絕對酌情權認為必要為有蓋行人天橋的未來連接段的任何支撐物及連接物)(統稱「**有蓋行人天橋**」)，以便行人可通過有蓋行人天橋出入行人通道(按批地文件特別條款第(36)(a)條定義)。有蓋行人天橋須按署長要求與批准的材料、標準、水平、定線、佈局及設計建造，包括但不限於提供與建造支撐物、斜道、輔助樓梯及梯台、扶手電梯、升降機，傷殘人士用斜道或升降機和署長自行酌情要求的內部及外部固定物及附著物及照明裝置。每座有蓋行人天橋的內部淨寬度須有不少於6.0米或運輸署署長可批准的其他寬度和2.6米的內部最低淨空高度。
- (ii) 按署長要求或批准修改在批地文件所夾附的圖則上顯示並註明“**EXISTING FB**”的現有行人天橋連同其一切支撐物及連接物(包括署長有絕對酌情權認為必要為現有行人天橋的未來連接段的任何支撐物及連接物)(統稱「**現有天橋**」)並在該地段的擬建建築物內提供與建造現有行人天橋的支撐物、連接物及延伸物(統稱「**現有行人天橋的支撐物、連接物及延伸物**」)，以便行人及單車使用者可經過現有行人天橋出入行人通道(按批地文件特別條款第(36)(a)條定義)。現有行人天橋的修改與延長須包括提供1條2.8米寬或運輸署署長可決定的其他寬度的單車徑。現有行人天橋支撐物、連接物及延伸物須按署長要求與批准的材料、規格、標準、水平、定線、佈局、設計及位置建造，包括但不限於提供與建造支撐物、斜道、輔助樓梯及梯台、扶手電梯、升降機，傷殘人士用斜道或升降機和署長自行酌情要求的內部及外部固定物及附著物及照明裝置。

(c) 即使此等條款有任何相反的規定，承批人須於批地文件約定的批租年期內自費維修、管理及保養有蓋行人天橋和現有行人天橋支撐物、連接物、延伸物及承批人按批地文件特別條款第(35)(g)條可能建造的任何替代物處於清潔、井然及良好的維修及狀態，在一切方面使署長滿意。

- (e) (i) 不能使用有蓋行人天橋和現有行人天橋的支撐物、連接物及延伸物作一切公眾人士徒步或乘坐輪椅或單車通過以外的其他用途。
 - (ii) 除非署長另作批准或要求，承批人不能使用或准許或容許他人使用有蓋行人天橋和現有行人天橋的支撐物、連接物及延伸物的外部或內部作廣告或展示任何標誌、通告或各種海報。
 - (iii) 承批人不能在有蓋行人天橋和現有行人天橋的支撐物、連接物及延伸物作出或准許或容許他人作出任何事情以致對經過有蓋行人天橋和現有行人天橋的支撐物、連接物及延伸物下面的任何人員或車輛或毗鄰或附近的地段或物業的任何業主或佔用人造成滋擾、煩擾、不便或損害。
 - (iv) 承批人須在有蓋行人天橋存在的整個期間准許一切公眾人士為了合法目的每日24小時自由及免付任何費用不受阻礙地徒步或乘坐輪椅或騎單車經過、再經過、上落有蓋行人天橋。
 - (v) 承批人須在現有行人天橋的支撐物、連接物及延伸物存在的整個期間准許一切公眾人士為了合法目的每日24小時自由及免付任何費用不受阻礙地徒步或乘坐輪椅或騎單車經過、再經過、上落現有行人天橋的支撐物、連接物及延伸物。
- (h) 批地文件保留給政府、其官員、代理人、承辦商、工人及其他正式授權人士及毋須支付任何費用：
- (i) 為了於現有行人天橋的外部及該地段內搭建、安裝、維修及保養署長(其意見將為最終論並對承批人有約束力)認為規管車輛及行人交通所必要的街燈、交通標誌、交通信號及其他設備的一切必要進出及往返該地段的權利。
 - (ii) 一切必要進出及往返該地段的權利，旨在視察、檢查、監督、管理、保持、維修及保養現有行人天橋和進行重建或翻新所必要的勘測及測量工作。
 - (iii) 連接現有行人天橋至現有行人天橋的支撐物、連接物及延伸物的權利。
- (i) 如果承批人進行的建築工程影響出入現有行人天橋，承批人須自費提供臨時通道供公眾於每日24小時免付任何費用、不受阻礙地出入現有行人天橋，使運輸署署長滿意。

Information on public facilities and public open spaces

公共設施及公眾休憩用地的資料

(II) 主公契的條文

B章 一定義

「商業發展項目」指及包括按經批准圖則已建或擬建用作商業或零售用途的屋苑該等部分及包括屋苑該等部分的外牆、屋苑由4樓樓板水平至6樓天花水平的外牆(不論由該等外牆所圍封的屋苑部分是否構成商業發展項目的部分)(不包括構成專上學院項目一部分的外牆)、按批地文件特別條件第(43)(b)條提供作停泊屬於商業發展項目的佔用人和他們的真正賓客、訪客或獲邀請者的汽車及電單車的停車位(包括B3商業停車位)、按批地文件特別條件第(44)(a)(ii)條提供並指定給商業發展項目使用的上落貨車停車位、輔助行車道及迴旋處、樓梯、(若屋苑該等部分緊貼大圍站之上)在大圍站上層邊界上面屋苑部分的所有樓板，包括防水膜上面的所有樓板及飾面及其上面的系統及輔助保護裝置、供商業發展項目或其中任何部分的一切公用事業、服務、溝渠及設施、商業發展項目的所有外部飾面、部分24小時行人道、部分行人通道、供整個商業發展項目的綠化地帶之所有部分(將在商業發展項目的分公契內指定為商業公用地方之部分)、平台護牆、單車停車場、單車徑、有蓋行人天橋(不論是該土地邊界以內或以外)及現有行人天橋的支撐物、連接物及延伸物，但不包括屬於住宅發展項目、住宅停車場、政府樓宇、屋苑公用地方、住宅公用地方、住宅停車場公用地方及B3商業停車場公用地方之部分，上述商業發展項目(如果可以在圖則上予以識別和顯示)於主公契所夾附的平面圖則上以橙色和橙色間黑斜線顯示，僅作識別之用。

「有蓋行人天橋」指按批地文件特別條件第(35)(a)(i)條在批地文件所夾附的圖則上顯示與註明“PROPOSED FB 1”和“PROPOSED FB 2”的大約位置已經或將會建造及提供署長要求或批准的2座單層有蓋行人天橋連同其一切支撐物及連接物，以便行人可通過有蓋行人天橋出入行人通道。

「屋苑公用地方」指其用途為供整個屋苑使用，而並非屋苑的任何個別業主或若干業主獨家享用的屋苑該等部分，包括但不限於供整個屋苑的綠化地帶的所有該等部分、在大圍站上層邊界上面屋苑部分的所有樓板，包括防水膜上面的所有樓板及其上面的系統及輔助保護裝置、供屋苑的一切公用事業、服務、溝渠及設施、屋苑的所有飾面、部分後移範圍、部分24小時行人道、部分行人通道、渠務專用範圍或新渠務專用範圍(視情況而定)、水務工程專用範圍、行車道、升降機、入口及出口、公共停車處、專上學院停車處、現有公廁項目、專上學院項目、公共運輸交匯處項目、地庫4樓至地庫1樓之空心牆及地下連接牆、3樓天花以下之外牆、飾面及建築裝飾(不包括該等構成商業發展項目的外牆部分及其飾面及建築裝飾)、6樓天花以上至天台之滾筒斜道之外牆、斜道、升降機槽、穿梭升降機、行人徑、樓梯、梯台、走廊及通道；泵房、變壓器房、主電掣房、電力房、消防控制室、主儀錶櫃及水錶房、燃料箱房、街道消防栓及花灑和消防泵房、風機房、花灑控制室、管槽、緊急發電機房、通風槽、垃圾存放及物料回收房、垃圾收集站和按批地文件特別條件第(52)(b)(i)條提供的垃圾車停泊、上落貨用的停車位；護牆、結構牆及支柱、地基及屋苑上的建築物的其他結構件；管理處、保安員室、警衛室、管理員櫃位、業主委員會及/或業主立案法團辦事處、儲物室、洗手間和屋苑之上或之內用作管理員辦事處的其他區域或業主委員會或業主立案法團的其他樓宇和該屋苑內並非供屋苑任何個別業主或若干業主獨家享用的一切其他公用地方(但不包括商業發展項目、住宅公用地方、住宅停車場公用地方、B3商業停車場公用地方及第一業主按主公契訂立的分公契或平邊契據指定或將指定為公用地方的該等區域)。第1期和第2期的屋苑公用地方(如果可以在圖則上予以識別和顯示)於主公契所夾附的圖則上以綠色、綠色間黑斜線、綠色間黑交叉線顯示，及於主公契所夾附的公用地方劃分圖上以綠色、綠色間黑斜線及綠色間黑交叉線(就第1期內的部分而言)及綠色間紅色虛線(就第2期內的部分而言)顯示，僅作識別之用。其他期數的屋苑公用地方將在有關期數的任何分公契或平邊契據所夾附的圖則上標明。

「現有天橋」指批地文件特別條件第(35)(a)(ii)條規定署長要求或批准在批地文件所夾附的圖則上顯示並註明“EXISTING FB”的現有行人天橋連同一切支撐物及連接物。

「現有行人天橋的支撐物、連接物及延伸物」指按批地文件特別條件第(35)(a)(ii)條已經或將會建造及提供的現有行人天橋的支撐物、連接物及延伸物，以便行人和單車使用者可通過現有行人天橋出入行人通道。

附表二第II部分

第4(c)條 批地文件特別條件第(35)(e)(iv)和(v)條規定，公眾人士有權在有蓋行人天橋和現有行人天橋的支撐物、連接物及延伸物存在的整個期間為了一切為了合法目的每日24小時自由及免付任何費用不受阻礙地徒步或乘坐輪椅或騎單車經過、再經過、上落有蓋行人天橋和現有行人天橋的支撐物、連接物及延伸物。

第5條 批地文件保留給政府、其官員、代理人、承辦商、工人及其他正式授權人士及毋須支付任何費用：

(a) 一切必要進出及往返該地段的權利，署長認為必要(其意見將為最終論並對承批人有約束力)旨在現有行人天橋的外部及該地段內搭建、安裝、維修及保養的街燈、交通標誌、交通信號及其他設備，以便規管車輛及行人交通。

(b) 一切必要進出及往返該地段的權利，旨在視察、檢查、監督、管理、保持、維修及保養現有行人天橋和進行重建或翻新所必要的勘測及測量工作。

(c) 有權連接現有行人天橋至現有行人天橋的支撐物、連接物及延伸物。

附表三 — 第1(ar)條

遵從主公契附表二第II部分第3條保留予第一業主之權利、主公契及批地文件保留予擔任政府樓宇業主的財政司司長法團之權利、地役權和特權、主公契附表二第I部分第3條訂明授予及保留予大圍站業主之權利、車站轉讓契約訂明授予及保留予擔任大圍站業主的九廣鐵路之權利以及主公契附表二第I部分第6條訂明授予商業發展項目業主之權利，任何業主均不可

...

除非署長另作批准或要求，使用或准許或容許他人使用有蓋行人天橋和現有行人天橋的支撐物、連接物及延伸物的外部或內部作廣告或展示任何標誌、通告或各種海報。

Information on public facilities and public open spaces

公共設施及公眾休憩用地的資料

8. 24小時行人道

(I) 批地文件的條文

特別條款第(36)條

(d) (i) 承批人須在該地段及其上面已建或擬建的任何建築物內設計與提供和其後管理與保養一條行人道，包括署長要求或批准的扶手電梯、乘客升降機、樓梯、斜道及其他構築物(該行人道在下文稱為「**24小時行人道**」)，以便連接大圍站、現有公廁、現有公共運輸交匯處、新的公共運輸交匯處、單車停車場、單車徑、專上學院、有蓋行人天橋、現有行人天橋、批地文件特別條款第(49)(a)條提述的專上學院停車處、批地文件特別條款第(50)(a)條提述的公共停車處、該地段的地面和毗鄰該地段的街道水平行人徑，在一切方面使署長滿意。承批人須提交一份顯示24小時行人道的路徑圖則給署長批核。署長就甚麼構成該地段的地面水平和街道水平的決定是最終決定並對承批人有約束力。

(ii) 24小時行人道(不包括扶手電梯、乘客升降機、樓梯、斜道及其他構築物)須有不少于4.5米的內部淨寬度。

(e) 承批人須於批地文件約定的批租年期內保持24小時行人道開放給公眾為了合法目的每日24小時徒步或乘坐輪椅免付任何費用、不受阻礙地使用。承批人須自費保持按批地文件特別條款第(36)(d)(i)條提供的扶手電梯和乘客升降機每日24小時運作，使署長滿意。

(II) 主公契的條文

B章 — 定義

「24小時行人道」指按批地文件特別條件第(36)(d)(i)條在該土地的地面已經或將會建造及提供的行人道和毗鄰該土地的街道水平的行人徑，包括署長要求或批准的扶手電梯、乘客升降機、樓梯、斜道及其他構築物，以便連接大圍站、政府樓宇、單車停車場、單車徑、有蓋行人天橋、現有行人天橋、專上學院停車處，上述24小時行人道於主公契所夾附的圖則上以橙色間黑斜線、綠色間黑斜線及靛藍色間黑斜線顯示，僅作識別之用。

「商業發展項目」指及包括按經批准圖則已建或擬建用作商業或零售用途的屋苑該等部分及包括屋苑該等部分的外牆、屋苑由4樓樓板水平至6樓天花水平的外牆(不論由該等外牆所圍封的屋苑部分是否構成商業發展項目的部分)(不包括構成專上學院項目一部分的外牆)、按批地文件特別條件第(43)(b)條提供作停泊屬於商業發展項目的佔用人和他們的真正賓客、訪客或獲邀請者的汽車及電單車的停車位(包括B3商業停車位)、按批地文件特別條件第(44)(a)(ii)條提供並指定給商業發展項目使用的上落貨車停車位、輔助行車道及迴旋處、樓梯、(若屋苑該等部分緊貼大圍站之上)在大圍站上層邊界上面屋苑部分的所有樓板，包括防水膜上面的所有樓板及飾面及其上面的系統及輔助保護裝置、供商業發展項目或其中任何部分的一切公用事業、服務、溝渠及設施、商業發展項目的所有外部飾面、部分24小時行人道、部分行人通道、供整個商業發展項目的綠化地帶之所有部分(將在商業發展項目的分公契內指定為商業公用地方之部分)、平台護牆、單車停車場、單車徑、有蓋行人天橋(不論是該土地邊界以內或以外)及現有行人天橋的支撐物、連接物及延伸物，但不包括屬於住宅發展項目、住宅停車場、政府樓宇、屋苑公用地方、住宅公用地方、住宅停車場公用地方及B3商業停車場公用地方之部分，上述商業發展項目(如果可以在圖則上予以識別和顯示)於主公契所夾附的平面圖則上以橙色和橙色間黑斜線顯示，僅作識別之用。

「屋苑公用地方」指其用途為供整個屋苑使用，而並非屋苑的任何個別業主或若干業主獨家享用的屋苑該等部分，包括但不限於供整個屋苑的綠化地帶的所有該等部分、在大圍站上層邊界上面屋苑部分的所有樓板，包括防水膜上面的所有樓板及其上面的系統及輔助保護裝置、供屋苑的一切公用事業、服務、溝渠及設施、屋苑的所有飾面、部分後移範圍、部分24小時行人道、部分行人通道、渠務專用範圍或新渠務專用範圍(視情況而定)、水務工程專用範圍、行車道、升降機、入口及出口、公共停車處、專上學院停車處、現有公廁項目、專上學院項目、公共運輸交匯處項目、地庫4樓至地庫1樓之空心牆及地下連接牆、3樓天花以下之外牆、飾面及建築裝飾(不包括該等構成商業發展項目的外牆部分及其飾面及建築裝飾)、6樓天花以上至天台之滾筒斜道之外牆、斜道、升降機槽、穿梭升降機、行人徑、樓梯、梯台、走廊及通道；泵房、變壓器房、主電掣房、電力房、消防控制室、主儀錶櫃及水錶房、燃料箱房、街道消防栓及花灑和消防泵房、風機房、花灑控制室、管槽、緊急發電機房、通風槽、垃圾存放及物料回收房、垃圾收集站和按批地文件特別條件第(52)(b)(i)條提供的垃圾車停泊、上落貨用的停車位；護牆、結構牆及支柱、地基及屋苑上的建築物的其他結構件；管理處、保安員室、警衛室、管理員櫃位、業主委員會及/或業主立案法團辦事處、儲物室、洗手間和屋苑之上或之內用作管理員辦事處的其他區域或業主委員會或業主立案法團的其他樓宇和該屋苑內並非供屋苑任何個別業主或若干業主獨家享用的一切其他公用地方(但不包括商業發展項目、住宅公用地方、住宅停車場公用地方、B3商業停車場公用地方及第一業主按主公契訂立的分公契或平邊契據指定或將指定為公用地方的該等區域)。第1期和第2期的屋苑公用地方(如果可以在圖則上予以識別和顯示)於主公契所夾附的圖則上以綠色、綠色間黑斜線、綠色間黑交叉線顯示，及於主公契所夾附的公用地方劃分圖上以綠色、綠色間黑斜線及綠色間黑交叉線(就第1期內的部分而言)及綠色間紅色虛線(就第2期內的部分而言)顯示，僅作識別之用。其他期數的屋苑公用地方將在有關期數的任何分公契或平邊契據所夾附的圖則上標明。

E章 — 第26條

(a) 批地文件特別條件第(36)(e)條規定，商業發展項目業主須於批地文件約定的批租年期內自費保持在商業發展項目內已經或可能建造的部分24小時行人道開放給公眾為了一切合法目的每日24小時徒步或乘坐輪椅免付任何費用不受阻礙地使用。

(b) 批地文件特別條件第(36)(e)條規定，屋苑業主(不包括擔任政府樓宇業主的財政司司長法團)須於批地文件約定的批租年期內自費保持在屋苑公用地方內已經或可能建造的部分24小時行人道開放給公眾為了一切合法目的每日24小時徒步或乘坐輪椅免付任何費用不受阻礙地使用。

附表二第II部分 — 第4(b)條

批地文件特別條件第(36)(e)條規定，公眾人士有權為了一切合法目的於批地文件約定的批租年期內每日24小時徒步或乘坐輪椅免付任何費用不受阻礙地使用24小時行人道。

Information on public facilities and public open spaces

公共設施及公眾休憩用地的資料

9. 公共停車處

(I) 批地文件的條文

特別條款第(50)條

- (a) 承批人須在2022年9月30日或之前或署長可指定的其他期限按署長可批准的條件自費在翠田街與車公廟道交匯處旁邊該地段的地面水平或署長指定的其他地點(署長就甚麼構成該地段的地面水平的決定是最終決定並對承批人有約束力)提供和其後管理與保養不少於1個尺寸為3.5米寬及40.0米總長的公共停車處，供車輛(包括的士)上落客之用(「公共停車處」)，並使署長滿意。承批人須在展開建築工程之前提交或促使他人提交詳細的公共停車處設計建議給運輸署長作書面批核。
- (e) 根據批地文件特別條款第(50)(a)條於該地段內提供的公共停車處須指定為及構成公用地方之一部分。
- (f) 承批人須於批地文件約定的批租年期內保持公共停車處開放給公眾每日24小時免費、不受阻礙地使用並使署長滿意。

(II) 主公契的條文

B章 — 定義

「屋苑公用地方」指其用途為供整個屋苑使用，而並非屋苑的任何個別業主或若干業主獨家享用的屋苑該等部分，包括但不限於供整個屋苑的綠化地帶的所有該等部分、在大圍站上層邊界上面屋苑部分的所有樓板，包括防水膜上面的所有樓板及其上面的系統及輔助保護裝置、供屋苑的一切公用事業、服務、溝渠及設施、屋苑的所有飾面、部分後移範圍、部分24小時行人道、部分行人通道、渠務專用範圍或新渠務專用範圍(視情況而定)、水務工程專用範圍、行車道、升降機、入口及出口、公共停車處、專上學院停車處、現有公廁項目、專上學院項目、公共運輸交匯處項目、地庫4樓至地庫1樓之空心牆及地下連接牆、3樓天花以下之外牆、飾面及建築裝飾(不包括該等構成商業發展項目的外牆部分及其飾面及建築裝飾)、6樓天花以上至天台之滾筒斜道之外牆、斜道、升降機槽、穿梭升降機、行人徑、樓梯、梯台、走廊及通道；泵房、變壓器房、主電掣房、電力房、消防控制室、主儀錶櫃及水錶房、燃料箱房、街道消防栓及花灑和消防泵房、風機房、花灑控制室、管槽、緊急發電機房、通風槽、垃圾存放及物料回收房、垃圾收集站和按批地文件特別條件第(52)(b)(i)條提供的垃圾車停泊、上落貨用的停車位；護牆、結構牆及支柱、地基及屋苑上的建築物的其他結構件；管理處、保安員室、警衛室、管理員櫃位、業主委員會及/或業主立案法團辦事處、儲物室、洗手間和屋苑之上或之內用作管理員辦事處的其他區域或業主委員會或業主立案法團的其他樓宇和該屋苑內並非供屋苑任何個別業主或若干業主獨家享用的一切其他公用地方(但不包括商業發展項目、住宅公用地方、住宅停車場公用地方、B3商業停車場公用地方及第一業主按主公契訂立的分公契或平邊契據指定或將指定為公用地方的該等區域)。第1期和第2期的屋苑公用地方(如果可以在圖則上予以識別和顯示)於主公契所夾附的圖則上以綠色、綠色間黑斜線、綠色間黑交叉線顯示，及於主公契所夾附的公用地方劃分圖上以綠色、綠色間黑斜線及綠色間黑交叉線(就第1期內的部分而言)及綠色間紅色虛線(就第2期內的部分而言)顯示，僅作識別之用。其他期數的屋苑公用地方將在有關期數的任何分公契或平邊契據所夾附的圖則上標明。

「公共停車處」指按批地文件特別條件第(50)(a)條已經或將會在翠田街與車公廟道交匯處旁邊該土地的地面水平(或署長可決定的其他位置)提供的公共停車處，構成屋苑公用地方之部分，供車輛(包括的士)上落客之用，在一切方面使署長滿意。

附表二 第II部分 — 第4(h)條

批地文件特別條件第(50)(f)條規定，公眾人士有權於批地文件約定的批租年期內每日24小時免付任何費用不受阻礙地使用公共停車處。

10. 渠務專用範圍及新渠務專用範圍

(I) 批地文件的條文

特別條款第(60)條

(a) 不能在批地文件所夾附的圖則上以粉紅色間黑交叉線、粉紅色間黑交叉線加黑點、粉紅色間黑交叉線加紅點、粉紅色間黑交叉線加紅點黑斜線顯示的範圍(上述有顏色範圍在下文統稱「渠務專用範圍」)之上、上方、之下、上面、下面或之內搭建或建築或安置任何建築物、構築物、地基或任何建築物或構築物的支撐物。不能在渠務專用範圍種植根部有穿透能力的樹木或灌木，除了：

- (i) 批地文件特別條款第(60)(f)(i)條提述的現有構築物或承托物包括現有排水管道及重置排水管道、批地文件特別條款第(61)(i)條提述的現有總水喉、於批地文件之日在渠務專用範圍之上、之下、上方、下方或之內已搭建、建造或安置的現有公廁及現有公共運輸交匯處；
- (ii) 新的公共運輸交匯處；
- (iii) 地面車輛引道；
- (iv) 地面公眾通道；
- (v) 專上學院停車處和公共停車處；
- (vi) 獲署長批准的其他構築物。
- (f) (i) 承批人須應渠務署署長要求自費將目前在渠務專用範圍內於批地文件所夾附圖則上以紅色線劃定的位置的排水管道改道至批地文件所夾附圖則上以綠色線劃定的新位置(「改道工程」)。當完成該改道工程後，渠務專用範圍將縮減到批地文件所夾附的圖則上以粉紅色間黑交叉線加黑點、粉紅色間黑交叉線加紅點、粉紅色間黑交叉線加紅點黑斜線顯示的較小範圍(「新渠務專用範圍」)。批地文件特別條款第(60)(a)至(e)條將適用於新渠務專用範圍。
- (ii) 在展開改道工程之前，承批人必須取得渠務署署長的預先書面批准並採取一切必要的預防措施，確保改道工程不影響渠務專用範圍內的現有排水系統之運作。

Information on public facilities and public open spaces

公共設施及公眾休憩用地的資料

(II) 主公契的條文

B章一定義

「渠務專用範圍」指批地文件特別條件第(60)(a)條提述在批地文件所夾附的圖則上以粉紅色間黑交叉線、粉紅色間黑交叉線加黑點、粉紅色間黑交叉線加紅點、粉紅色間黑交叉線加紅點黑斜線顯示該土地的範圍。

「屋苑公用地方」指其用途為供整個屋苑使用，而並非屋苑的任何個別業主或若干業主獨家享用的屋苑該等部分，包括但不限於供整個屋苑的綠化地帶的所有該等部分、在大圍站上層邊界上面屋苑部分的所有樓板，包括防水膜上面的所有樓板及其上面的系統及輔助保護裝置、供屋苑的一切公用事業、服務、溝渠及設施、屋苑的所有飾面、部分後移範圍、部分24小時行人道、部分行人通道、渠務專用範圍或新渠務專用範圍(視情況而定)、水務工程專用範圍、行車道、升降機、入口及出口、公共停車處、專上學院停車處、現有公廁項目、專上學院項目、公共運輸交匯處項目、地庫4樓至地庫1樓之空心牆及地下連接牆、3樓天花以下之外牆、飾面及建築裝飾(不包括該等構成商業發展項目的外牆部分及其飾面及建築裝飾)、6樓天花以上至天台之滾筒斜道之外牆、斜道、升降機槽、穿梭升降機、行人徑、樓梯、梯台、走廊及通道；泵房、變壓器房、主電掣房、電力房、消防控制室、主儀錶櫃及水錶房、燃料箱房、街道消防柱及花灑和消防泵房、風機房、花灑控制室、管槽、緊急發電機房、通風槽、垃圾存放及物料回收房、垃圾收集站和按批地文件特別條件第(52)(b)(i)條提供的垃圾車停泊、上落貨用的停車位；護牆、結構牆及支柱、地基及屋苑上的建築物的其他結構件；管理處、保安員室、警衛室、管理員櫃位、業主委員會及/或業主立案法團辦事處、儲物室、洗手間和屋苑之上或之內用作管理員辦事處的其他區域或業主委員會或業主立案法團的其他樓宇和該屋苑內並非供屋苑任何個別業主或若干業主獨家享用的一切其他公用地方(但不包括商業發展項目、住宅公用地方、住宅停車場公用地方、B3商業停車場公用地方及第一業主按主公契訂立的分公契或平邊契據指定或將指定為公用地方的該等區域)。第1期和第2期的屋苑公用地方(如果可以在圖則上予以識別和顯示)於主公契所夾附的圖則上以綠色、綠色間黑斜線、綠色間黑交叉線顯示，及於主公契所夾附的公用地方劃分圖上以綠色、綠色間黑斜線及綠色間黑交叉線(就第1期內的部分而言)及綠色間紅色虛線(就第2期內的部分而言)顯示，僅作識別之用。其他期數的屋苑公用地方將在有關期數的任何分公契或平邊契據所夾附的圖則上標明。

「新渠務專用範圍」指當根據批地文件特別條件第(60)(f)條完成渠務專用範圍內的改道工程後，批地文件特別條件第(60)(f)條提述在批地文件所夾附的圖則上以粉紅色間黑交叉線加黑點、粉紅色間黑交叉線加紅點、粉紅色間黑交叉線加紅點黑斜線顯示該土地的範圍。

E章 — 第20條

批地文件特別條件第(60)(d)條規定，業主須於批租年期內，允許署長及其正式授權的官員、承辦商和他們的工人隨時，不論攜帶工具、設備、機器或駕車與否，不受限制地通行、進出、往返及行經該土地，以便在渠務專用範圍鋪設、檢查、修理和維修署長規定或批准現時橫貫、經過渠務專用範圍或新渠務專用範圍(視情況而定)或位於其下的排水渠、污水管、渠道、排水設施及所有其他服務設施。

I章 — 第1(b)(xviii)條

茲毋損前文之一般規定，管理人將具有以下各項權力及職責：

...

允許署長及其正式授權的官員、承辦商和他們的工人隨時，不論攜帶工具、設備、機器或駕車與否，有權出入、經過及再經過該土地，以便在渠務專用範圍鋪設、檢查、修理和維修署長根據批地文件特別條件第(60)(d)及(f)(i)條規定或批准現時橫貫、經過渠務專用範圍或新渠務專用範圍或位於其下的排水渠、污水管、渠道、排水設施及所有其他服務設施。

11. 後移範圍

(i) 批地文件的條文

特別條款第(62)條

- (a) 除批地文件特別條款第(60)條規定外，未經署長的預先書面同意，不能在本批地文件所夾附圖則上以粉紅色間黑斜線和粉紅色間黑交叉線加紅點黑斜線顯示該地段的地面之上、上方或上面搭建、建造或放置任何建築物或構築物或建築物或構築物的支撐物和儲存或放置任何物件或各種材料(統稱「後移範圍」)。
- (b) 即使批地文件特別條款第(62)(a)條規定，承批人可在後移範圍內搭建或允許他人搭建經批准園景設計總圖或城市規劃委員會批准的任何總規劃圖所顯示的園景及康樂設施、天篷、有蓋行人路、其他構築物和署長可書面批准的其他構築物或設施。
- (d) 承批人須於批地文件約定的批租年期內保持後移範圍開放給公眾為了合法目的每日24小時自由及不受阻礙地使用並使署長滿意。
- (h) 承批人須於批地文件約定的批租年期內，自費管理與保養後移範圍和按批地文件特別條款第(62)(b)條在其上面已建或擬建的一切構築物及設施處於修繕良好的狀態並使署長滿意。

Information on public facilities and public open spaces

公共設施及公眾休憩用地的資料

(II) 主公契的條文

B章一定義

「屋苑公用地方」指其用途為供整個屋苑使用，而並非屋苑的任何個別業主或若干業主獨家享用的屋苑該等部分，包括但不限於供整個屋苑的綠化地帶的所有該等部分、在大圍站上層邊界上面屋苑部分的所有樓板，包括防水膜上面的所有樓板及其上面的系統及輔助保護裝置、供屋苑的一切公用事業、服務、溝渠及設施、屋苑的所有飾面、部分後移範圍、部分24小時行人道、部分行人通道、渠務專用範圍或新渠務專用範圍(視情況而定)、水務工程專用範圍、行車道、升降機、入口及出口、公共停車處、專上學院停車處、現有公廁項目、專上學院項目、公共運輸交匯處項目、地庫4樓至地庫1樓之空心牆及地下連接牆、3樓天花以下之外牆、飾面及建築裝飾(不包括該等構成商業發展項目的外牆部分及其飾面及建築裝飾)、6樓天花以上至天台之滾筒斜道之外牆、斜道、升降機槽、穿梭升降機、行人徑、樓梯、梯台、走廊及通道；泵房、變壓器房、主電掣房、電力房、消防控制室、主儀錶櫃及水錶房、燃料箱房、街道消防栓及花灑和消防泵房、風機房、花灑控制室、管槽、緊急發電機房、通風槽、垃圾存放及物料回收房、垃圾收集站和按批地文件特別條件第(52)(b)(i)條提供的垃圾車停泊、上落貨用的停車位；護牆、結構牆及支柱、地基及屋苑上的建築物的其他結構件；管理處、保安員室、警衛室、管理員櫃位、業主委員會及/或業主立案法團辦事處、儲物室、洗手間和屋苑之上或之內用作管理員辦事處的其他區域或業主委員會或業主立案法團的其他樓宇和該屋苑內並非供屋苑任何個別業主或若干業主獨家享用的一切其他公用地方(但不包括商業發展項目、住宅公用地方、住宅停車場公用地方、B3商業停車場公用地方及第一業主按主公契訂立的分公契或平邊契據指定或將指定為公用地方的該等區域)。第1期和第2期的屋苑公用地方(如果可以在圖則上予以識別和顯示)於主公契所夾附的圖則上以綠色、綠色間黑斜線、綠色間黑交叉線顯示，及於主公契所夾附的公用地方劃分圖上以綠色、綠色間黑斜線及綠色間黑交叉線(就第1期內的部分而言)及綠色間紅色虛線(就第2期內的部分而言)顯示，僅作識別之用。其他期數的屋苑公用地方將在有關期數的任何分公契或平邊契據所夾附的圖則上標明。

「後移範圍」指批地文件特別條件第(62)(a)條提述在批地文件所夾附的圖則上以粉紅色間黑斜線和粉紅色間黑交叉線加紅點黑斜線顯示的該範圍；

附表二 第II部分 一 第4(d)條

批地文件特別條件第(62)(d)條規定，公眾人士有權為了一切合法目的於批地文件約定的批租年期內每日24小時免付任何費用不受阻礙地使用後移範圍。

B. 根據批地文件規定須由發展項目中的住宅物業的擁有人出資管理、營運或維持以供公眾使用的任何設施

1. 綠色區域及構築物

(I) 批地文件的條文

特別條款第(5)(a)條

承批人須：

(i) 於2022年9月30日或在署長可能批准的其他日期或之前，自費並按署長批准的方式、物料、標準、水平、定線和設計進行下述工程，並在各方面使署長滿意：

(I) 在批地文件所夾附的圖則上以綠色顯示的部分(「綠色區域」)鋪設及興建部份未來公共道路；及

(II) 提供及建造該等橋樑、隧道、上跨路、下通道、下水道、高架道路、天橋、行人道、道路或署長自行酌情要求的其他構築物(「該等構築物」)；

使綠色區域內的建築、車輛、行人及單車的交通往來；

(ii) 於2022年9月30日或在署長可能批准的其他日期或之前，自費在綠色區域鋪設路面、建造路緣及開水道，並提供署長規定的溝渠、污水渠、排水渠、消防栓連接駁至總水管的水管、街燈、交通標誌、街道設施、路面標記及植物，以達至署長滿意程度；及

(iii) 自費保養綠色區域連同該等構築物及在該區域之上或之內建造、安裝及提供的該等構築物、表面、溝渠、污水渠、排水渠、消防栓連接駁至總水管的水管、服務設施、街燈、交通標誌、街道設施、路面標記和植物，以達至署長滿意程度及直至綠色區域已由承批人根據批地文件特別條款第(6)條交回政府管有為止。

特別條款第(6)條

僅為了進行批地文件特別條款第(5)條指明的必要工程，綠色區域的管有權將會在批地文件訂立之日批予承批人。綠色區域或任何部分須於政府要求時交還給政府，而在任何情況下，承批人在署長發信表示此等條款已符合並使其滿意之日便當作已交還給政府。承批人須於所有合理時間在其管有綠色區域或任何部分期間，准許所有政府及公共車輛、行人及單車使用者自由進入、通過及經過綠色區域或其中部分，並確保該項進入的權利不受進行的工程干擾或阻礙，不論是按照批地文件的特別條款第(5)條或其他規定進行的工程。

特別條款第(7)條

承批人未獲得署長事先書面同意不可在綠色區域儲物或在該處搭建任何臨時構築物，或用作進行批地文件特別條款第(5)條指明的工程以外的其他用途。

Information on public facilities and public open spaces

公共設施及公眾休憩用地的資料

特別條款第(8)(a)條

承批人須在管有綠色區域期間，於所有合理時間內：

- (i) 准許政府、署長及其官員、承辦商與代理人及署長授權的任何其他人士有權自由及不受限制出入、經過及往返該地段及綠色區域或其中部分，旨在視察、檢查及監管批地文件的特別條款第(5)(a)條指定的工程及監管批地文件的特別條款第(5)(b)條的工程及署長認為有必要在綠色區域或其中部分進行的任何其他工程；
- (ii) 在政府和政府授權的有關公用事業公司要求時准許其有權自由及不受限制出入、經過及往返該地段及綠色區域或其中部分，旨在綠色區域或其中部分或任何毗鄰土地之內、之上或之下進行任何工程，包括但不限於鋪設和其後保養一切管道、電線、導管、電纜槽及其他傳導媒介及輔助設備，以便提供電話、電力、氣體(如有)及其他服務給該地段或任何毗鄰或毗連土地及建築。承批人須充分配合政府及政府正式授權的有關公用事業公司在綠色區域或其中部分內進行上述工程的一切事宜；及
- (iii) 在水務監督的官員及其授權的其他人士要求時准許其有權自由及不受限制出入、經過及往返該地段及綠色區域或其中部分，旨在進行有關操作、保養、修理、更換、更改綠色區域或其中部分內的任何其他水務工程裝置。

(II) 主公契的條文

B章 — 定義

「綠色區域」指批地文件特別條件第(5)(a)(i)(I)條提述在批地文件所夾附的圖則上以綠色顯示的部分未來公共道路；

「構築物」批地文件特別條件第(5)(a)(i)(II)條定義的構築物；

「其他構築物及設施」指根據批地文件特別條件第(5)(a)(iii)條在綠色區域之上或之內建造、安裝及提供的所有構築物、表面、溝渠、污水渠、排水渠、消防栓、服務設施、街燈、交通標誌、街道設施、路面標記和植物，使署長滿意。

E章 — 第18條

- (a) 業主(大圍站業主和擔任政府樓宇業主的財政司司長法團除外)須自費保養綠色區域連同該等構築物及根據批地文件特別條件第(5)(a)(iii)條提供的其他構築物及設施直至綠色區域已根據批地文件特別條件第(6)條交回政府管有為止。
- (b) 承批人須於所有合理時間在其管有綠色區域或任何部分，允許所有政府及公共車輛、行人及單車使用者自由進入、通過及經過綠色區域或其中部分，並確保該項進入的權利不受進行的工程干擾或阻礙，不論是按照批地文件特別條件第(5)條或其他規定進行的工程。

- (c) 承批人須於所有合理時間在其管有綠色區域或任何部分，允許署長、及其人員、承辦商、代理及其他獲署長授權人士、政府及獲政府授權的相關公共事業公司、水務監督之人員及他們授權之人士有權出入及經過該土地及綠色區域或其中部分，以便進行、視察、檢查及監督根據批地文件特別條件第(8)(a)條進行的工程。

I章 — 第1(b)(xvi)條

茲毋損前文之一般規定，管理人將具有以下各項權力及職責：

...

允許署長、及其人員、承辦商、代理及其他獲署長授權人士、政府及獲政府授權的相關公共事業公司、水務監督之人員及他們授權之人士有權出入、經過及再經過該土地及綠色區域，以便進行、視察、檢查及監督根據批地文件特別條件第(8)(a)條進行的工程。

J章 — 第2(a)(i)條

管理人須設立及保持由下列獨立賬戶所組成的一個特別基金：

...

設立一個屋苑特別基金賬戶，用作支付有關現有公廁項目、專上學院項目及主公契E章第10條規定業主(擔任政府樓宇業主的財政司司長法團除外)負責的公共運輸交匯處項目、斜坡及護土構築物、預製地樁(如有)、綠色區域、構築物及其他構築物及設施、屋苑公用地方及/或屋苑公用服務及設施的資本性質的主要工程或並非預期每年支出的開支，包括但不限於修復、改善及維修有公廁項目、專上學院項目及公共運輸交匯處項目、斜坡及護土構築物、預製地樁(如有)、綠色區域、構築物及其他構築物及設施、屋苑公用地方及/或屋苑公用服務及設施的開支，購買、設置、更換、改善及增加屋苑公用地方及/或屋苑公用服務及設施的開支和有關勘測工程及專業服務的費用。

J章 — 第4(i)(i)條

(i) 管理人須編製下列預算：

- (i) 一份屋苑管理預算，列明管理與保養現有公廁項目、專上學院項目及主公契E章第10條規定業主(擔任政府樓宇業主的財政司司長法團除外)負責的公共運輸交匯處項目、斜坡及護土構築物、預製地樁(如有)、綠色區域、構築物及其他構築物及設施、屋苑公用地方及屋苑公用服務及設施的預計開支，包括屋苑特別基金賬戶的供款和管理人酬金的一個適當部分，但不包括歸屬住宅發展項目、商業發展項目或住宅停車位的開支。

Information on public facilities and public open spaces

公共設施及公眾休憩用地的資料

2. 現有公廁、公共運輸交匯處項目及專上學院項目

(I) 批地文件的條文

特別條款第(16)條

- (i) (i) 承批人須於批地文件約定的批租年期內，自費保養以下項目(「現有公廁項目」)，在一切方面使署長滿意：
- (I) 現有公廁的外部飾面和現有公廁之中、之內、周圍、內部、之上及之下的一切牆壁、支柱、橫樑、天花板、天台板、軌道或樓板的結構及任何其他結構件；
- (II) 供現有公廁和該地段的發展項目餘下部分的一切升降機、扶手電梯及樓梯；
- (III) 供構成現有公廁和該地段的發展項目餘下部分之部分系統的一切建築服務裝置、機械及設備(包括但不限於攜帶式和固定消防裝置設備)；
- (IV) 現有公廁下的一切結構板連同其內及其下的排水系統；及
- (V) 供現有公廁和該地段的發展項目餘下部分的一切其他公用部分及設施。
- (ii) 承批人須就其未能保養現有公廁項目而引致或導致一切任何性質的責任、賠償、開支、申索、成本、索償、費用、法律行動及程序彌償政府及財政司司長法團，並保證他們獲得彌償。
- (iii) 就本(i)分條而言，「承批人」一詞不包括財政司司長法團。

特別條款第(19)條

- (a) 承批人須於批地文件約定的批租年期內，自費保養下列項目(「公共運輸交匯處項目」)，在一切方面使署長滿意：
- (i) 現有公共運輸交匯處和新的公共運輸交匯處的外飾面和現有公共運輸交匯處和新的公共運輸交匯處之中、之內、周圍、內部、之上及之下的一切牆壁、支柱、橫樑、天花板、天台板、軌道或樓板的結構及任何其他結構件；
- (ii) 供現有公共運輸交匯處和新的公共運輸交匯處或兩者和該地段的發展項目餘下部分的一切升降機、扶手電梯及樓梯；
- (iii) 構成供現有公共運輸交匯處或新的公共運輸交匯處或兩者和該地段的發展項目餘下部分的系統之部分的一切建築服務裝置、機械及設備(包括但不限於手攜式及固定消防裝置設備)；
- (iv) 現有公共運輸交匯處和新的公共運輸交匯處或兩者下面的一切結構板連同其內或其下的排水系統；

(v) 供現有公共運輸交匯處和新的公共運輸交匯處或兩者和該地段的發展項目餘下部分的一切其他公用地方及設施。

(b) 承批人須就未能保養公共運輸交匯處項目而引或導致一切任何性質的責任、賠償、開支、申索、成本、索償、費用、法律行動及程序彌償政府及財政司司長法團(按批地文件特別條款第(16)(h)(i)條定義)，並保證他們獲得彌償。

(c) 就本特別條款而言，「承批人」一詞不包括財政司司長法團。

特別條款第(22)條

- (i) (i) 承批人須於批地文件約定的批租年期內，自費保養下列項目(「專上學院項目」)，在一切方面使署長滿意：
- (I) 專上學院的外飾面和專上學院之中、之內、周圍、內部、之上及之下的一切牆壁、支柱、橫樑、天花板、天台板、軌道或樓板的結構及任何其他結構件；
- (II) 供專上學院和該地段的發展項目餘下部分的一切升降機、扶手電梯及樓梯；
- (III) 構成供專上學院和該地段的發展項目餘下部分的系統之部分的一切建築服務裝置、機械及設備(包括但不限於手攜式及固定消防裝置設備)；
- (IV) 專上學院下面的一切結構板連同其內或其下的排水系統；
- (V) 供專上學院和該地段的發展項目餘下部分的一切其他公用地方及設施。

(II) 主公契的條文

B章 一定義

「現有公廁項目」指批地文件特別條件第(16)(i)(i)條提述的(i)現有公廁的外部飾面和現有公廁之中、之內、周圍、內部、之上及之下的一切牆壁、支柱、橫樑、天花板、天台板、軌道或樓板的結構及任何其他結構件；(ii)供現有公廁和發展項目餘下部分的一切升降機、扶手電梯及樓梯；(iii)供構成現有公廁和發展項目餘下部分之部分系統的一切建築服務裝置、機械及設備(包括但不限於攜帶式和固定消防裝置設備)；(iv)現有公廁下的一切結構板連同其內及其下的排水系統；及(v)供現有公廁和發展項目餘下部分的一切其他公用部分及設施。

「公共運輸交匯處項目」指批地文件特別條件第(19)(a)條提述的(i)現有公共運輸交匯處和新的公共運輸交匯處的外飾面和現有公共運輸交匯處和新的公共運輸交匯處之中、之內、周圍、內部、之上及之下的一切牆壁、支柱、橫樑、天花板、天台板、軌道或樓板的結構及任何其他結構件；(ii)供現有公共運輸交匯處和新的公共運輸交匯處或兩者和該地段的發展項目餘下部分的一切升降機、扶手電梯及樓梯；(iii)供構成現有公共運輸交匯處或新的公共運輸交匯處或兩者和發展項目餘下部分的系統之部分的一切建築服務裝置、機械及設備(包括但不限於手攜式及固定消防裝置設備)；(iv)現有公共運輸交匯處和新的公共運輸交匯處或兩者下面的一切結構板連同其內或其下的排水系統；及(v)供現有公共運輸交匯處和新的公共運輸交匯處或兩者和發展項目餘下部分的一切其他公用地方及設施。

Information on public facilities and public open spaces

公共設施及公眾休憩用地的資料

「專上學院項目」指批地文件特別條件第(22)(l)(i)條提述的(i)專上學院的外飾面和專上學院之中、之內、周圍、內部、之上及之下的一切牆壁、支柱、橫樑、天花板、天台板、軌道或樓板的結構及任何其他結構件；(ii)供專上學院和該地段的發展項目餘下部分的一切升降機、扶手電梯及樓梯；(iii)供構成專上學院和發展項目餘下部分的系統之部分的一切建築服務裝置、機械及設備(包括但不限於手攜式及固定消防裝置設備)；(iv)專上學院下面的一切結構板連同其內或其下的排水系統；及(v)供專上學院和發展項目餘下部分的一切其他公用地方及設施。

E章 – 第9條

- (a) 政府樓宇業主僅負責保養與管理政府設施的所有部分(不包括現有公廁項目、專上學院項目及公共運輸交匯處項目)，但對發展項目任何其他部分或該土地之外的任何區域、設施或服務毋須負責。
- (b) 政府樓宇業主毋須負責支付按主契J章第5條計算的管理費或主契J章第9(a)和9(c)條列明的任何按金。

E章 - 第10條

業主(擔任政府樓宇業主的財政司司長法團除外)須通過管理人負責按批地文件特別條件第(16)(i)、22(l)(i)及(19)(a)條保養、管理及維修現有公廁項目、專上學院項目及公共運輸交匯處項目並對未能保養、管理及維修現有公廁項目、專上學院項目及公共運輸交匯處項目所產生或引致的一切訴訟、司法程序、責任、索償、費用、開支、損害賠償、要求及申索彌償政府和財政司司長法團並保證其被彌償。

I章 – 第1(b)(xii)條

茲毋損前文之一般規定，管理人將具有以下各項權力及職責：

...

主契E章第10條規定，業主(擔任政府樓宇業主的財政司司長法團除外)須負責保養、管理及保持現有公廁項目、專上學院項目及公共運輸交匯處項目處於修繕良好的狀態。

J章 – 第1(n)條

就管理人管理屋苑和履行其任何職責或行使任何權力而必需及合理地產生的費用、收費及開支，須包括但不限於以下各項，且各屋苑業主須按照以下規定的方式支付：

...

主契E章第10條規定，業主(擔任政府樓宇業主的財政司司長法團除外)須負責管理、維修及操作現有公廁項目、專上學院項目及公共運輸交匯處項目的費用。

J章 – 第4(i)(i)條

- (i) 管理人須編製下列預算：
- (i) 一份屋苑管理預算，列明管理與保養現有公廁項目、專上學院項目及主契E章第10條規定業主(擔任政府樓宇業主的財政司司長法團除外)負責的公共運輸交匯處項目、斜坡及護土構築物、預製地樁(如有)、綠色區域、構築物及其他構築物及設施、屋苑公用地方及屋苑公用服務及設施的預計開支，包括屋苑特別基金賬戶的供款和管理人酬金的一個適當部分，但不包括歸屬住宅發展項目、商業發展項目或住宅停車位的開支。

3. 單車停車場及單車徑

(l) 批地文件的條文

特別條款第(20)條

- (a) 承批人須在2022年9月30日或之前或署長可指定的期限內按署長可批准的條件在新的公共運輸交匯處附近的位置或署長可決定的其他位置自費以精工細作的方式搭建與建造和其後保養與管理一個單車停車場(「單車停車場」)，其範圍涵蓋330個停車位或署長可批准的其他數目，供公眾停泊單車。承批人須在展開工程之前提交或促使他人提交詳細的設計建議給運輸署長作書面批核。
- (c) 承批人須於批地文件約定的批租年期內，保持單車停車場每日24小時開放給公眾使用，除臨時關閉單車停車場或其中任何部分以便進行保養工程。

特別條款第(21)條

- (a) 承批人須在2022年9月30日或之前或署長可指定的期限內按署長可批准的條件自費提供和其後保養與管理一條淨寬度不少於3.5米的單車徑(「單車徑」)，以便銜接單車停車場和毗鄰的單車徑，確保延續沙田新市鎮的單車徑網絡。
- (e) 承批人須於批地文件約定的批租年期內，保持單車徑每日24小時開放給單車使用者(不論是否騎著單車)不受阻礙地經過及再經過單車徑。

Information on public facilities and public open spaces

公共設施及公眾休憩用地的資料

(II) 主公契的條文

B章 一定義

「單車停車場」指按批地文件特別條件第(20)(a)條已經或將會建造和其後保養與管理供公眾停泊單車的單車停車場，構成商業發展項目之部分，在一切方面使署長滿意。

「單車徑」指按批地文件特別條件第(21)條已經或將會提供和其後保養與管理的單車徑，構成商業發展項目之部分，以便銜接單車停車場和毗鄰的單車徑，確保延續沙田新市鎮的單車徑網絡，在一切方面使署長滿意。

「商業發展項目」指及包括按經批准圖則已建或擬建用作商業或零售用途的屋苑該等部分及包括屋苑該等部分的外牆、屋苑由4樓樓板水平至6樓天花水平的外牆(不論由該等外牆所圍封的屋苑部分是否構成商業發展項目的部分)(不包括構成專上學院項目一部分的外牆)、按批地文件特別條件第(43)(b)條提供作停泊屬於商業發展項目的佔用人和他們的真正賓客、訪客或獲邀請者的汽車及電單車的停車位(包括B3商業停車位)、按批地文件特別條件第(44)(a)(ii)條提供並指定給商業發展項目使用的上落貨車停車位、輔助行車道及迴旋處、樓梯、(若屋苑該等部分緊貼大圍站之上)在大圍站上層邊界上面屋苑部分的所有樓板，包括防水膜上面的所有樓板及飾面及其上面的系統及輔助保護裝置、供商業發展項目或其中任何部分的一切公用事業、服務、溝渠及設施、商業發展項目的所有外部飾面、部分24小時行人道、部分行人通道、供整個商業發展項目的綠化地帶之所有部分(將在商業發展項目的分公契內指定為商業公用地方之部分)、平台護牆、單車停車場、單車徑、有蓋行人天橋(不論是該土地邊界以內或以外)及現有行人天橋的支撐物、連接物及延伸物，但不包括屬於住宅發展項目、住宅停車場、政府樓宇、屋苑公用地方、住宅公用地方、住宅停車場公用地方及B3商業停車場公用地方之部分，上述商業發展項目(如果可以在圖則上予以識別和顯示)於主公契所夾附的平面圖則上以橙色和橙色間黑斜線顯示，僅作識別之用。

附表二第II部分 一 第4條

- (e) 公眾人士有權於批地文件約定的批租年期內每日24小時使用單車停車場，除臨時關閉單車停車場或其中任何部分以便進行批地文件特別條件第(20)(c)條規定的保養工程。
- (f) 批地文件特別條件第(21)(e)條規定，於批地文件約定的批租年期內必須保持單車徑每日24小時開放給單車使用者(不論是否騎著單車)免費及不受阻礙地經過及再經過單車徑。

4. 有蓋行人天橋、現有天橋、現有行人天橋的支撐物、連接物及延伸物

(I) 批地文件的條文

特別條款第(35)條

- (a) 承批人須在2022年9月30日或之前或署長可指定的期限內按署長批准的條件自費建造下列項目，在一切方面使署長滿意：
- (i) 在批地文件所夾附的圖則上顯示與註明“PROPOSED FB 1”和“PROPOSED FB 2”的大約位置搭建、建造及提供署長要求或批准的2座單層有蓋行人天橋連同其一切支撐物及連接物(包括署長有絕對酌情權認為必要為有蓋行人天橋的未來連接段的任何支撐物及連接物)(統稱「有蓋行人天橋」)，以便行人可通過有蓋行人天橋出入行人通道(按批地文件特別條款第(36)(a)條定義)。有蓋行人天橋須按署長要求與批准的材料、標準、水平、定線、佈局及設計建造，包括但不限於提供與建造支撐物、斜道、輔助樓梯及梯台、扶手電梯、升降機，傷殘人士用斜道或升降機和署長自行酌情要求的內部及外部裝置及附著物及照明裝置。每座有蓋行人天橋的內部淨寬度須有不少於6.0米或運輸署署長可批准的其他寬度和2.6米的內部最低淨空高度。
- (ii) 按署長要求或批准修改在批地文件所夾附的圖則上顯示並註明“EXISTING FB”的現有行人天橋連同一切支撐物及連接物(包括署長有絕對酌情權認為必要為現有行人天橋的未來連接段的任何支撐物及連接物)(統稱「現有天橋」)並在該地段的擬建建築物內提供與建造現有行人天橋的支撐物、連接物及延伸物(統稱「現有行人天橋的支撐物、連接物及延伸物」)，以便行人及單車使用者可經過現有行人天橋出入行人通道(按批地文件特別條款第(36)(a)條定義)。現有行人天橋的修改與延長須包括提供1條2.8米寬或運輸署署長可決定的其他寬度的單車徑。現有行人天橋支撐物、連接物及延伸物須按署長要求與批准的材料、規格、標準、水平、定線、佈局、設計及位置建造，包括但不限於提供與建造支撐物、斜道、輔助樓梯及梯台、扶手電梯、升降機，傷殘人士用斜道或升降機和署長自行酌情要求的內部及外部固定物及附著物及照明裝置。
- (c) 即使此等條款有任何相反的規定，承批人須於批地文件約定的批租年期內自費維修、管理及保養有蓋行人天橋和現有行人天橋支撐物、連接物、延伸物及承批人按批地文件特別條款第(35)(g)條可能建造的任何替代物處於清潔、井然及良好的維修及狀態，在一切方面使署長滿意。
- (e) (i) 不能使用有蓋行人天橋和現有行人天橋的支撐物、連接物及延伸物作一切公眾人士徒步或乘坐輪椅或單車通過以外的其他用途。
- (ii) 除非署長另作批准或要求，承批人不能使用或准許或容許他人使用有蓋行人天橋和現有行人天橋的支撐物、連接物及延伸物的外部或內部作廣告或展示任何標誌、通告或各種海報。
- (iii) 承批人不能在有蓋行人天橋和現有行人天橋的支撐物、連接物及延伸物作出或准許或容許他人作出任何事情以致對經過有蓋行人天橋和現有行人天橋的支撐物、連接物及延伸物下面的任何人員或車輛或毗鄰或附近的地段或物業的任何業主或佔用人造成滋擾、煩擾、不便或損害。

Information on public facilities and public open spaces

公共設施及公眾休憩用地的資料

(iv) 承批人須在有蓋行人天橋存在的整個期間准許一切公眾人士為了合法目的每日24小時自由及免付任何費用不受阻礙地徒步或乘坐輪椅或騎單車經過、再經過、上落有蓋行人天橋。

(v) 承批人須在現有行人天橋的支撐物、連接物及延伸物存在的整個期間准許一切公眾人士為了合法目的每日24小時自由及免付任何費用不受阻礙地徒步或乘坐輪椅或騎單車經過、再經過、上落現有行人天橋的支撐物、連接物及延伸物。

(l) 如果承批人進行的建築工程影響出入現有行人天橋，承批人須自費提供臨時通道供公眾於每日24小時免付任何費用、不受阻礙地出入現有行人天橋，使運輸署署長滿意。

(ii) 主公契的條文

B章 一定義

「商業發展項目」指及包括按經批准圖則已建或擬建用作商業或零售用途的屋苑該等部分及包括屋苑該等部分的外牆、屋苑由4樓樓板水平至6樓天花水平的外牆(不論由該等外牆所圍封的屋苑部分是否構成商業發展項目的部分)(不包括構成專上學院項目一部分的外牆)、按批地文件特別條件第(43)(b)條提供作停泊屬於商業發展項目的佔用人和他們的真正賓客、訪客或獲邀請者的汽車及電單車的停車位(包括B3商業停車位)、按批地文件特別條件第(44)(a)(ii)條提供並指定給商業發展項目使用的上落貨車停車位、輔助行車道及迴旋處、樓梯、(若屋苑該等部分緊貼大圍站之上)在大圍站上層邊界上面屋苑部分的所有樓板，包括防水膜上面的所有樓板及飾面及其上面的系統及輔助保護裝置、供商業發展項目或其中任何部分的一切公用事業、服務、溝渠及設施、商業發展項目的所有外部飾面、部分24小時行人道、部分行人通道、供整個商業發展項目的綠化地帶之所有部分(將在商業發展項目的分公契內指定為商業公用地方之部分)、平台護牆、單車停車場、單車徑、有蓋行人天橋(不論是該土地邊界以內或以外)及現有行人天橋的支撐物、連接物及延伸物，但不包括屬於住宅發展項目、住宅停車場、政府樓宇、屋苑公用地方、住宅公用地方、住宅停車場公用地方及B3商業停車場公用地方之部分，上述商業發展項目(如果可以在圖則上予以識別和顯示)於主公契所夾附的平面圖則上以橙色和橙色間黑斜線顯示，僅作識別之用。

「有蓋行人天橋」指按批地文件特別條件第(35)(a)(i)條在批地文件所夾附的圖則上顯示與註明“**PROPOSED FB 1**”和“**PROPOSED FB 2**”的大約位置已經或將會建造及提供署長要求或批准的2座單層有蓋行人天橋連同其一切支撐物及連接物，以便行人可通過有蓋行人天橋出入行人通道。

「屋苑公用地方」指其用途為供整個屋苑使用，而並非屋苑的任何個別業主或若干業主獨家享用的屋苑該等部分，包括但不限於供整個屋苑的綠化地帶的所有該等部分、在大圍站上層邊界上面屋苑部分的所有樓板，包括防水膜上面的所有樓板及其上面的系統及輔助保護裝置、供屋苑的一切公用事業、服務、溝渠及設施、屋苑的所有飾面、部分後移範圍、部分24小時行人道、部分行人通道、渠務專用範圍或新渠務專用範圍(視情況而定)、水務工程專用範圍、行車道、升降機、入口及出口、公共停車處、專上學院停車處、現有公廁項目、專上學院項目、公共運輸交匯處項目、地庫4樓至地庫1樓之空心牆及地下連接牆、3樓天花以下之外牆、飾面及建築裝飾(不包括該等構成商業發展項目的外牆部分及其飾面及建築裝飾)、6樓天花以上至天台之滾筒斜道之外牆、斜道、升降機槽、穿梭升降機、行人徑、樓梯、梯台、走廊及通道；泵房、變壓器房、主電掣房、電力房、消防控制室、主儀錶櫃及水錶房、燃料箱房、街道消防栓及花灑和消防泵房、風機房、花灑控制室、管槽、緊急發電機房、通風槽、垃圾存放及物料回收房、垃圾收集站和按批地文件特別條件第(52)(b)(i)條提供的垃圾車停泊、上落貨用的停車位；護牆、結構牆及支柱、地基及屋苑上的建築物的其他結構件；管理處、保安員室、警衛室、管理員櫃位、業主委員會及/或業主立案法團辦事處、儲物室、洗手間和屋苑之上或之內用作管理員辦事處的其他區域或業主委員會或業主立案法團的其他樓宇和該屋苑內並非供屋苑任何個別業主或若干業主獨家享用的一切其他公用地方(但不包括商業發展項目、住宅公用地方、住宅停車場公用地方、B3商業停車場公用地方及第一業主按主公契訂立的分公契或平邊契據指定或將指定為公用地方的該等區域)。第1期和第2期的屋苑公用地方(如果可以在圖則上予以識別和顯示)於主公契所夾附的圖則上以綠色、綠色間黑斜線、綠色間黑交叉線顯示，及於主公契所夾附的公用地方劃分圖上以綠色、綠色間黑斜線及綠色間黑交叉線(就第1期內的部分而言)及綠色間紅色虛線(就第2期內的部分而言)顯示，僅作識別之用。其他期數的屋苑公用地方將在有關期數的任何分公契或平邊契據所夾附的圖則上標明。

「現有天橋」指批地文件特別條件第(35)(a)(ii)條規定署長要求或批准在批地文件所夾附的圖則上顯示並註明“**EXISTING FB**”的現有行人天橋連同一切支撐物及連接物。

「現有行人天橋的支撐物、連接物及延伸物」指按批地文件特別條件第(35)(a)(ii)條已經或將會建造及提供的現有行人天橋的支撐物、連接物及延伸物，以便行人和單車使用者可通過現有行人天橋出入行人通道。

附表二第II部分

第4(c)條 批地文件特別條件第(35)(e)(iv)和(v)條規定，公眾人士有權在有蓋行人天橋和現有行人天橋的支撐物、連接物及延伸物存在的整個期間為了一切為了合法目的每日24小時自由及免付任何費用不受阻礙地徒步或乘坐輪椅或騎單車經過、再經過、上落有蓋行人天橋和現有行人天橋的支撐物、連接物及延伸物。

第5條 批地文件保留給政府、其官員、代理人、承辦商、工人及其他正式授權人士及毋須支付任何費用：

(a) 一切必要進出及往返該地段的權利，署長認為必要(其意見將為最終論並對承批人有約束力)旨在現有行人天橋的外部及該地段內搭建、安裝、維修及保養的街燈、交通標誌、交通信號及其他設備，以便規管車輛及行人交通。

Information on public facilities and public open spaces

公共設施及公眾休憩用地的資料

(b) 一切必要進出及往返該地段的權利，旨在視察、檢查、監督、管理、保持、維修及保養現有行人天橋和進行重建或翻新所必要的勘測及測量工作。

(c) 有權連接現有行人天橋至現有行人天橋的支撐物、連接物及延伸物。

附表三 — 第1(ar)條

遵從主公契附表二第II部分第3條保留予第一業主之權利、主公契及批地文件保留予擔任政府樓宇業主的財政司司長法團之權利、地役權和特權、主公契附表二第I部分第3條訂明授予及保留予大圍站業主之權利、車站轉讓契約訂明授予及保留予擔任大圍站業主的九廣鐵路之權利以及主公契附表二第I部分第6條訂明授予商業發展項目業主之權利，任何業主均不可

...

除非署長另作批准或要求，使用或准許或容許他人使用有蓋行人天橋和現有行人天橋的支撐物、連接物及延伸物的外部或內部作廣告或展示任何標誌、通告或各種海報。

5. 24小時行人道

(I) 批地文件的條文

特別條款第(36)條

(d) (i) 承批人須在該地段及其上面已建或擬建的任何建築物內設計與提供和其後管理與保養一條行人道，包括署長要求或批准的扶手電梯、乘客升降機、樓梯、斜道及其他構築物(該行人道在下文稱為「24小時行人道」)，以便連接大圍站、現有公廁、現有公共運輸交匯處、新的公共運輸交匯處、單車停車場、單車徑、專上學院、有蓋行人天橋、現有行人天橋、批地文件特別條款第(49)(a)條提述的專上學院停車處、批地文件特別條款第(50)(a)條提述的公共停車處、該地段的地面和毗鄰該地段的街道水平行人徑，在一切方面使署長滿意。承批人須提交一份顯示24小時行人道的路徑圖則給署長批核。署長就甚麼構成該地段的地面水平和街道水平的決定是最終決定並對承批人有約束力。

(ii) 24小時行人道(不包括扶手電梯、乘客升降機、樓梯、斜道及其他構築物)須有不少於4.5米的內部淨寬度。

(e) 承批人須於批地文件約定的批租年期內保持24小時行人道開放給公眾為了合法目的每日24小時徒步或乘坐輪椅免付任何費用、不受阻礙地使用。承批人須自費保持按批地文件特別條款第(36)(d)(i)條提供的扶手電梯和乘客升降機每日24小時運作，使署長滿意。

(II) 主公契的條文

B章 — 定義

「24小時行人道」指按批地文件特別條件第(36)(d)(i)條在該土地的地面已經或將會建造及提供的行人道和毗鄰該土地的街道水平的行人徑，包括署長要求或批准的扶手電梯、乘客升降機、樓梯、斜道及其他構築物，以便連接大圍站、政府樓宇、單車停車場、單車徑、有蓋行人天橋、現有行人天橋、專上學院停車處，上述24小時行人道於主公契所夾附的圖則上以橙色間黑斜線、綠色間黑斜線及靛藍色間黑斜線顯示，僅作識別之用。

「商業發展項目」指及包括按經批准圖則已建或擬建用作商業或零售用途的屋苑該等部分及包括屋苑該等部分的外牆、屋苑由4樓樓板水平至6樓天花水平的外牆(不論由該等外牆所圍封的屋苑部分是否構成商業發展項目的部分)(不包括構成專上學院項目一部分的外牆)、按批地文件特別條件第(43)(b)條提供作停泊屬於商業發展項目的佔用人和他們的真正賓客、訪客或獲邀請者的汽車及電單車的停車位(包括B3商業停車位)、按批地文件特別條件第(44)(a)(ii)條提供並指定給商業發展項目使用的上落貨車停車位、輔助行車道及迴旋處、樓梯、(若屋苑該等部分緊貼大圍站之上)在大圍站上層邊界上面屋苑部分的所有樓板，包括防水膜上面的所有樓板及飾面及其上面的系統及輔助保護裝置、供商業發展項目或其中任何部分的一切公用事業、服務、溝渠及設施、商業發展項目的所有外部飾面、部分24小時行人道、部分行人通道、供整個商業發展項目的綠化地帶之所有部分(將在商業發展項目的分公契內指定為商業公用地方之部分)、平台護牆、單車停車場、單車徑、有蓋行人天橋(不論是該土地邊界以內或以外)及現有行人天橋的支撐物、連接物及延伸物，但不包括屬於住宅發展項目、住宅停車場、政府樓宇、屋苑公用地方、住宅公用地方、住宅停車場公用地方及B3商業停車場公用地方之部分，上述商業發展項目(如果可以在圖則上予以識別和顯示)於主公契所夾附的平面圖則上以橙色和橙色間黑斜線顯示，僅作識別之用。

「屋苑公用地方」指其用途為供整個屋苑使用，而並非屋苑的任何個別業主或若干業主獨家享用的屋苑該等部分，包括但不限於供整個屋苑的綠化地帶的所有該等部分、在大圍站上層邊界上面屋苑部分的所有樓板，包括防水膜上面的所有樓板及其上面的系統及輔助保護裝置、供屋苑的一切公用事業、服務、溝渠及設施、屋苑的所有飾面、部分後移範圍、部分24小時行人道、部分行人通道、渠務專用範圍或新渠務專用範圍(視情況而定)、水務工程專用範圍、行車道、升降機、入口及出口、公共停車處、專上學院停車處、現有公廁項目、專上學院項目、公共運輸交匯處項目、地庫4樓至地庫1樓之空心牆及地下連接牆、3樓天花以下之外牆、飾面及建築裝飾(不包括該等構成商業發展項目的外牆部分及其飾面及建築裝飾)、6樓天花以上至天台之滾筒斜道之外牆、斜道、升降機槽、穿梭升降機、行人徑、樓梯、梯台、走廊及通道；泵房、變壓器房、主電掣房、電力房、消防控制室、主儀錶櫃及水錶房、燃料箱房、街道消防栓及花灑和消防泵房、風機房、花灑控制室、管槽、緊急發電機房、通風槽、垃圾存放及物料回收房、垃圾收集站和按批地文件特別條件第(52)(b)(i)條提供的垃圾車停泊、上落貨用的停車位；護牆、結構牆及支柱、地基及屋苑上的建築物的其他結構件；管理處、保安員室、警衛室、管理員櫃位、業主委員會及/或業主立案法團辦事處、儲物室、洗手間和屋苑之上或之內用作管理員辦事處的其他區域或業主委員會或業主立案法團的其他樓宇和該屋苑內並非供屋苑任何個別業主或若干業主獨家享用的一切其他公用地方(但不包括商業發展項目、住宅公用地方、住宅停車場公用地方、B3商業停車場公用地方及第一業主按主公契訂立的分公契或平邊契據指定或將指定為公用地方的該等區域)。第1期和第2期的屋苑公用地方(如果可以在圖則上予以識別和顯示)於主公契所夾附的圖則上以綠色、綠色間黑斜線、綠色間黑交叉線顯示，及於主公契所夾附的公用地方劃分圖上以綠色、綠色間黑斜線及綠色間黑交叉線(就第1期內的部分而言)及綠色間紅色虛線(就第2期內的部分而言)顯示，僅作識別之用。其他期數的屋苑公用地方將在有關期數的任何分公契或平邊契據所夾附的圖則上標明。

Information on public facilities and public open spaces

公共設施及公眾休憩用地的資料

E章 — 第26條

- (a) 批地文件特別條件第(36)(e)條規定，商業發展項目業主須於批地文件約定的批租年期內自費保持在商業發展項目內已經或可能建造的部分24小時行人道開放給公眾為了一切合法目的每日24小時徒步或乘坐輪椅免付任何費用不受阻礙地使用。
- (b) 批地文件特別條件第(36)(e)條規定，屋苑業主(不包括擔任政府樓宇業主的財政司司長法團)須於批地文件約定的批租年期內自費保持在屋苑公用地方內已經或可能建造的部分24小時行人道開放給公眾為了一切合法目的每日24小時徒步或乘坐輪椅免付任何費用不受阻礙地使用。

附表二第II部分 — 第4(b)條

批地文件特別條件第(36)(e)條規定，公眾人士有權為了一切合法目的於批地文件約定的批租年期內每日24小時徒步或乘坐輪椅免付任何費用不受阻礙地使用24小時行人道。

6. 專上學院停車處

(i) 批地文件的條文

特別條款第(49)條

- (a) 承批人須在2022年9月30日或之前或署長可指定的其他期限按署長可批准的條件在該地段的地面水平(署長就甚麼構成該地段的地面水平和街道水平的決定是最終決定並對承批人有約束力)提供和其後管理與保養1個尺寸為3.5米寬、11.0米長、最低淨空高度為4.7米的停車處和不少於1個尺寸為2.5米寬、40米總長、最低淨空高度為2.4米的停車處，供與專上學院有關的車輛(包括的士)上落客之用(統稱為「專上學院停車處」)。
- (e) 根據批地文件特別條款第(49)(a)條於該地段內提供的專上學院停車處須指定為及構成公用地方之一部分。
- (f) 承批人須於批地文件約定的批租年期內並保持專上學院停車處開放給專上學院的佔用人和他們的真正來賓、訪客或被邀請者每日24小時免費不受阻礙地使用並使署長滿意。

(ii) 主公契的條文

B章 — 定義

「屋苑公用地方」指其用途為供整個屋苑使用，而並非屋苑的任何個別業主或若干業主獨家享用的屋苑該等部分，包括但不限於供整個屋苑的綠化地帶的所有該等部分、在大圍站上層邊界上面屋苑部分的所有樓板，包括防水膜上面的所有樓板及其上面的系統及輔助保護裝置、供屋苑的一切公用事業、服務、溝渠及設施、屋苑的所有飾面、部分後移範圍、部分24小時行人道、部分行人通道、渠務專用範圍或新渠務專用範圍(視情況而定)、水務工程專用範圍、行車道、升降機、入口及出口、公共停車處、專上學院停車處、現有公廁項目、專上學院項目、公共運輸交匯處項目、地庫4樓至地庫1樓之空心牆及地下連接牆、3樓天花以下之外牆、飾面及建築裝飾(不包括該等構成商業發展項目的外牆部分及其飾面及建築裝飾)、6樓天花以上至天台之滾筒斜道之外牆、斜道、升降機槽、穿梭升降機、行人徑、樓梯、梯台、走廊及通道；泵房、變壓器房、主電掣房、電力房、消防控制室、主儀錶櫃及水錶房、燃料箱房、街道消防栓及花灑和消防泵房、風機房、花灑控制室、管槽、緊急發電機房、通風槽、垃圾存放及物料回收房、垃圾收集站和按批地文件特別條件第(52)(b)(i)條提供的垃圾車停泊、上落貨用的停車位；護牆、結構牆及支柱、地基及屋苑上的建築物的其他結構件；管理處、保安員室、警衛室、管理員櫃位、業主委員會及/或業主立案法團辦事處、儲物室、洗手間和屋苑之上或之內用作管理員辦事處的其他區域或業主委員會或業主立案法團的其他樓宇和該屋苑內並非供屋苑任何個別業主或若干業主獨家享用的一切其他公用地方(但不包括商業發展項目、住宅公用地方、住宅停車場公用地方、B3商業停車場公用地方及第一業主按主公契訂立的分公契或平邊契據指定或將指定為公用地方的該等區域)。第1期和第2期的屋苑公用地方(如果可以在圖則上予以識別和顯示)於主公契所夾附的圖則上以綠色、綠色間黑斜線、綠色間黑交叉線顯示，及於主公契所夾附的公用地方劃分圖上以綠色、綠色間黑斜線及綠色間黑交叉線(就第1期內的部分而言)及綠色間紅色虛線(就第2期內的部分而言)顯示，僅作識別之用。其他期數的屋苑公用地方將在有關期數的任何分公契或平邊契據所夾附的圖則上標明。

「專上學院停車處」指按批地文件特別條件第(49)(a)條在該土地的地面上已經或將會提供的專上學院停車處，構成屋苑公用地方之部分，供與專上學院有關的車輛(包括的士)上落客之用，在一切方面使署長滿意，上述專上學院停車處(如果可以在圖則上予以識別和顯示)於主公契所夾附的地面圖則上以綠色間黑交叉線顯示，僅作識別之用。

附表二第II部分 — 第4(g)條

批地文件特別條件第(49)(f)條規定，專上學院的佔用人和他們的真正來賓、訪客或獲邀請者有權於批地文件約定的批租年期內每日24小時免費及不受阻礙地使用專上學院停車處。

Information on public facilities and public open spaces

公共設施及公眾休憩用地的資料

7. 公共停車處

(I) 批地文件的條文

特別條款第(50)條

- (a) 承批人須在2022年9月30日或之前或署長可指定的其他期限按署長可批准的條件在翠田街與車公廟道交匯處旁邊該地段的地面水平或署長指定的其他地點(署長就甚麼構成該地段的地面水平的決定是最終決定並對承批人有約束力)提供和其後管理與保養不少於1個尺寸為3.5米寬及40.0米總長的公共停車處，供車輛(包括的士)上落客之用(「公共停車處」)。承批人須在展開建築工程之前提交或促使他人提交詳細的公共停車處設計建議給運輸署長作書面批核。
- (e) 根據批地文件特別條款第(50)(a)條於該地段內提供的公共停車處須指定為及構成公用地方之一部分。
- (f) 承批人須於批地文件約定的批租年期內保持公共停車處開放給公眾每日24小時免費、不受阻礙地使用並使署長滿意。

(II) 主公契的條文

B章 一定義

「屋苑公用地方」指其用途為供整個屋苑使用，而並非屋苑的任何個別業主或若干業主獨家享用的屋苑該等部分，包括但不限於供整個屋苑的綠化地帶的所有該等部分、在大圍站上層邊界上面屋苑部分的所有樓板，包括防水膜上面的所有樓板及其上面的系統及輔助保護裝置、供屋苑的一切公用事業、服務、溝渠及設施、屋苑的所有飾面、部分後移範圍、部分24小時行人道、部分行人通道、渠務專用範圍或新渠務專用範圍(視情況而定)、水務工程專用範圍、行車道、升降機、入口及出口、公共停車處、專上學院停車處、現有公廁項目、專上學院項目、公共運輸交匯處項目、地庫4樓至地庫1樓之空心牆及地下連接牆、3樓天花以下之外牆、飾面及建築裝飾(不包括該等構成商業發展項目的外牆部分及其飾面及建築裝飾)、6樓天花以上至天台之滾筒斜道之外牆、斜道、升降機槽、穿梭升降機、行人徑、樓梯、梯台、走廊及通道；泵房、變壓器房、主電掣房、電力房、消防控制室、主儀錶櫃及水錶房、燃料箱房、街道消防栓及花灑和消防泵房、風機房、花灑控制室、管槽、緊急發電機房、通風槽、垃圾存放及物料回收房、垃圾收集站和按批地文件特別條款第(52)(b)(i)條提供的垃圾車停泊、上落貨用的停車位；護牆、結構牆及支柱、地基及屋苑上的建築物的其他結構件；管理處、保安員室、警衛室、管理員櫃位、業主委員會及/或業主立案法團辦事處、儲物室、洗手間和屋苑之上或之內用作管理員辦事處的其他區域或業主委員會或業主立案法團的其他樓宇和該屋苑內並非供屋苑任何個別業主或若干業主獨家享用的一切其他公用地方(但不包括商業發展項目、住宅公用地方、住宅停車場公用地方、B3商業停車場公用地方及第一業主按主公契訂立的分公契或平邊契據指定或將指定為公用地方的該等區域)。第1期和第2期的屋苑公用地方(如果可以在圖則上予以識別和顯示)於主公契所夾附的圖則上以綠色、綠色間黑斜線、綠色間黑交叉線顯示，及於主公契所夾附的公用地方劃分圖上以綠色、綠色間黑斜線及綠色間黑交叉線(就第1期內的部分而言)及綠色間紅色虛線(就第2期內的部分而言)顯示，僅作識別之用。其他期數的屋苑公用地方將在有關期數的任何分公契或平邊契據所夾附的圖則上標明。

「公共停車處」指按批地文件特別條款第(50)(a)條已經或將會在翠田街與車公廟道交匯處旁邊該土地的地面水平(或署長可決定的其他位置)提供的公共停車處，構成屋苑公用地方之部分，供車輛(包括的士)上落客之用，在一切方面使署長滿意。

附表二 第II部分 一 第4(h)條

批地文件特別條款第(50)(f)條規定，公眾人士有權於批地文件約定的批租年期內每日24小時免付任何費用不受阻礙地使用公共停車處。

8. 後移範圍

(I) 批地文件的條文

特別條款第(62)條

- (a) 除批地文件特別條款第(60)條規定外，未經署長的預先書面同意，不能在本批地文件所夾附圖則上以粉紅色間黑斜線和粉紅色間黑交叉線加紅點黑斜線顯示該地段的地面之上、上方或上面搭建、建造或放置任何建築物或構築物或建築物或構築物的支撐物和儲存或放置任何物件或各種材料(統稱「後移範圍」)。
- (b) 即使批地文件特別條款第(62)(a)條規定，承批人可在後移範圍內搭建或允許他人搭建經批准園景設計總圖或城市規劃委員會批准的任何總規劃圖所顯示的園景及康樂設施、天篷、有蓋行人路、其他構築物和署長可書面批准的其他構築物或設施。
- (d) 承批人須於批地文件約定的批租年期內保持後移範圍開放給公眾為了合法目的每日24小時自由及不受阻礙地使用並使署長滿意。
- (h) 承批人須於批地文件約定的批租年期內，自費管理與保養後移範圍和按批地文件特別條款第(62)(b)條在其上面已建或擬建的一切構築物及設施處於修繕良好的狀態並使署長滿意。

Information on public facilities and public open spaces

公共設施及公眾休憩用地的資料

(II) 主公契的條文

B章一定義

「屋苑公用地方」指其用途為供整個屋苑使用，而並非屋苑的任何個別業主或若干業主獨家享用的屋苑該等部分，包括但不限於供整個屋苑的綠化地帶的所有該等部分、在大圍站上層邊界上面屋苑部分的所有樓板，包括防水膜上面的所有樓板及其上面的系統及輔助保護裝置、供屋苑的一切公用事業、服務、溝渠及設施、屋苑的所有飾面、部分後移範圍、部分24小時行人道、部分行人通道、渠務專用範圍或新渠務專用範圍(視情況而定)、水務工程專用範圍、行車道、升降機、入口及出口、公共停車處、專上學院停車處、現有公廁項目、專上學院項目、公共運輸交匯處項目、地庫4樓至地庫1樓之空心牆及地下連接牆、3樓天花以下之外牆、飾面及建築裝飾(不包括該等構成商業發展項目的外牆部分及其飾面及建築裝飾)、6樓天花以上至天台之滾筒斜道之外牆、斜道、升降機槽、穿梭升降機、行人徑、樓梯、梯台、走廊及通道；泵房、變壓器房、主電掣房、電力房、消防控制室、主儀錶櫃及水錶房、燃料箱房、街道消防栓及花灑和消防泵房、風機房、花灑控制室、管槽、緊急發電機房、通風槽、垃圾存放及物料回收房、垃圾收集站和按批地文件特別條件第(52)(b)(i)條提供的垃圾車停泊、上落貨用的停車位；護牆、結構牆及支柱、地基及屋苑上的建築物的其他結構件；管理處、保安員室、警衛室、管理員櫃位、業主委員會及/或業主立案法團辦事處、儲物室、洗手間和屋苑之上或之內用作管理員辦事處的其他區域或業主委員會或業主立案法團的其他樓宇和該屋苑內並非供屋苑任何個別業主或若干業主獨家享用的一切其他公用地方(但不包括商業發展項目、住宅公用地方、住宅停車場公用地方、B3商業停車場公用地方及第一業主按主公契訂立的分公契或平邊契據指定或將指定為公用地方的該等區域)。第1期和第2期的屋苑公用地方(如果可以在圖則上予以識別和顯示)於主公契所夾附的圖則上以綠色、綠色間黑斜線、綠色間黑交叉線顯示，及於主公契所夾附的公用地方劃分圖上以綠色、綠色間黑斜線及綠色間黑交叉線(就第1期內的部分而言)及綠色間紅色虛線(就第2期內的部分而言)顯示，僅作識別之用。其他期數的屋苑公用地方將在有關期數的任何分公契或平邊契據所夾附的圖則上標明。

「後移範圍」指批地文件特別條件第(62)(a)條提述在批地文件所夾附的圖則上以粉紅色間黑斜線和粉紅色間黑交叉線加紅點黑斜線顯示的該範圍；

附表二 第II部分 — 第4(d)條

批地文件特別條件第(62)(d)條規定，公眾人士有權為了一切合法目的於批地文件約定的批租年期內每日24小時免付任何費用不受阻礙地使用後移範圍。

- C. 根據批地文件規定須由發展項目中的住宅物業的擁有人出資管理、營運或維持以供公眾使用的任何休憩用地不適用。
- D. 發展項目所位於的土地中為施行《建築物(規劃)規例》(第123章，附屬法例F)第22(1)條而撥供公眾用途的任何部分不適用。

Information on public facilities and public open spaces 公共設施及公眾休憩用地的資料



Legend 圖例

-  Pink hatched black
粉紅色加黑斜線
-  Pink cross-hatched black
粉紅色加黑交叉線
-  Pink cross-hatched black stippled black
粉紅色加黑交叉線加黑點
-  Pink cross-hatched black stippled red
粉紅色加黑交叉線加紅點
-  Pink cross-hatched black stippled red hatched black
粉紅色加黑交叉線加紅點黑斜線
-  Green
綠色

Remark : This plan is a reproduction of Plan I as annexed to the Land Grant, which shows the location of the relevant public facilities.

備註：此圖複製附於批地文件的圖則I，顯示相關公共設施的位置。

Information on public facilities and public open spaces 公共設施及公眾休憩用地的資料

B3/F Floor Plan
地庫3樓樓面平面圖

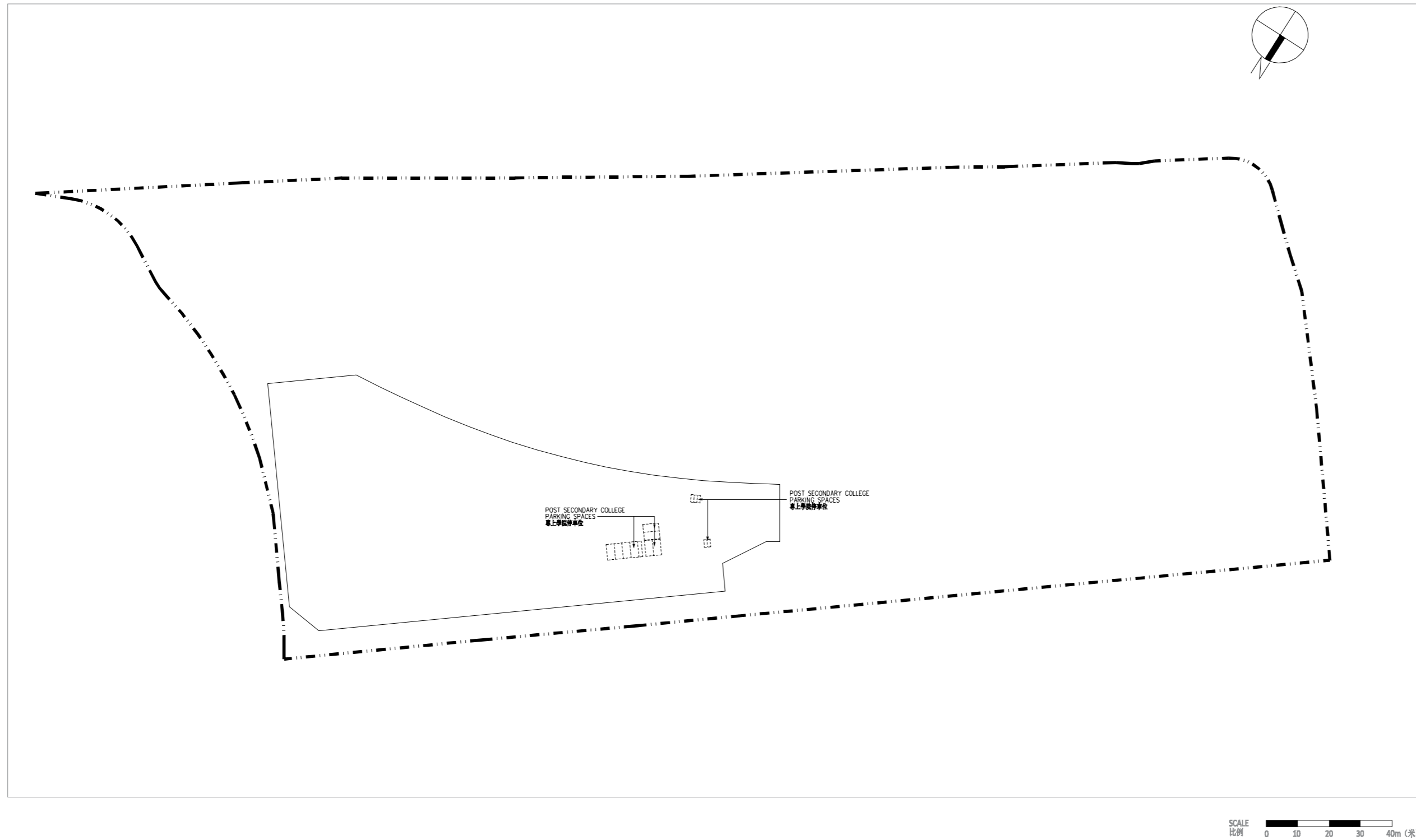

Boundary
Line of the
Development
發展項目的界線

Information on public facilities and public open spaces 公共設施及公眾休憩用地的資料

G/F Floor Plan 地下樓面平面圖

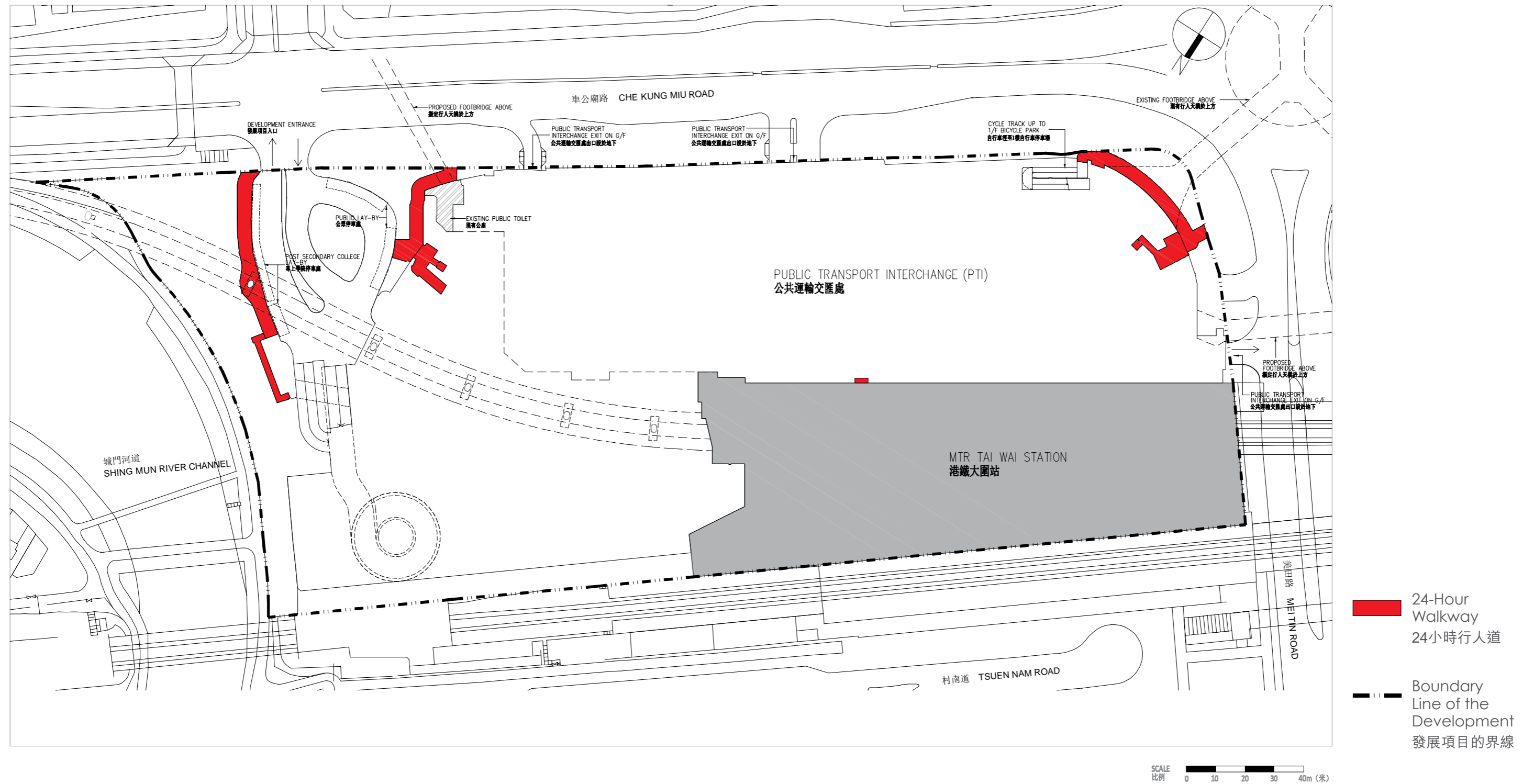

Remark :
The 24-Hour Walkway may not be available for use immediately upon completion of the Phase. Its use and/or operation shall be subject to the issue of consents or approvals by the relevant government authorities, relevant laws, the Land Grant, provisions of the deed of mutual covenants and restrictions of the on-site environment. According to the latest approved building plans, it is estimated that the 24-Hour Walkway shall be completed and open for use upon completion of the commercial portion of the Development.

備註：
24小時行人道在發展項目期數落成時未必能即時使用，其使用及/或運作可能受制於政府有關部門發出之同意書或許可証、相關法律、批地文件、公契條款及現場環境狀況限制。根據最新的經批准的建築圖則，24小時行人道預計將會在發展項目的商業部分落成時完成並開放。

Information on public facilities and public open spaces 公共設施及公眾休憩用地的資料

1/F Floor Plan 1樓樓面平面圖

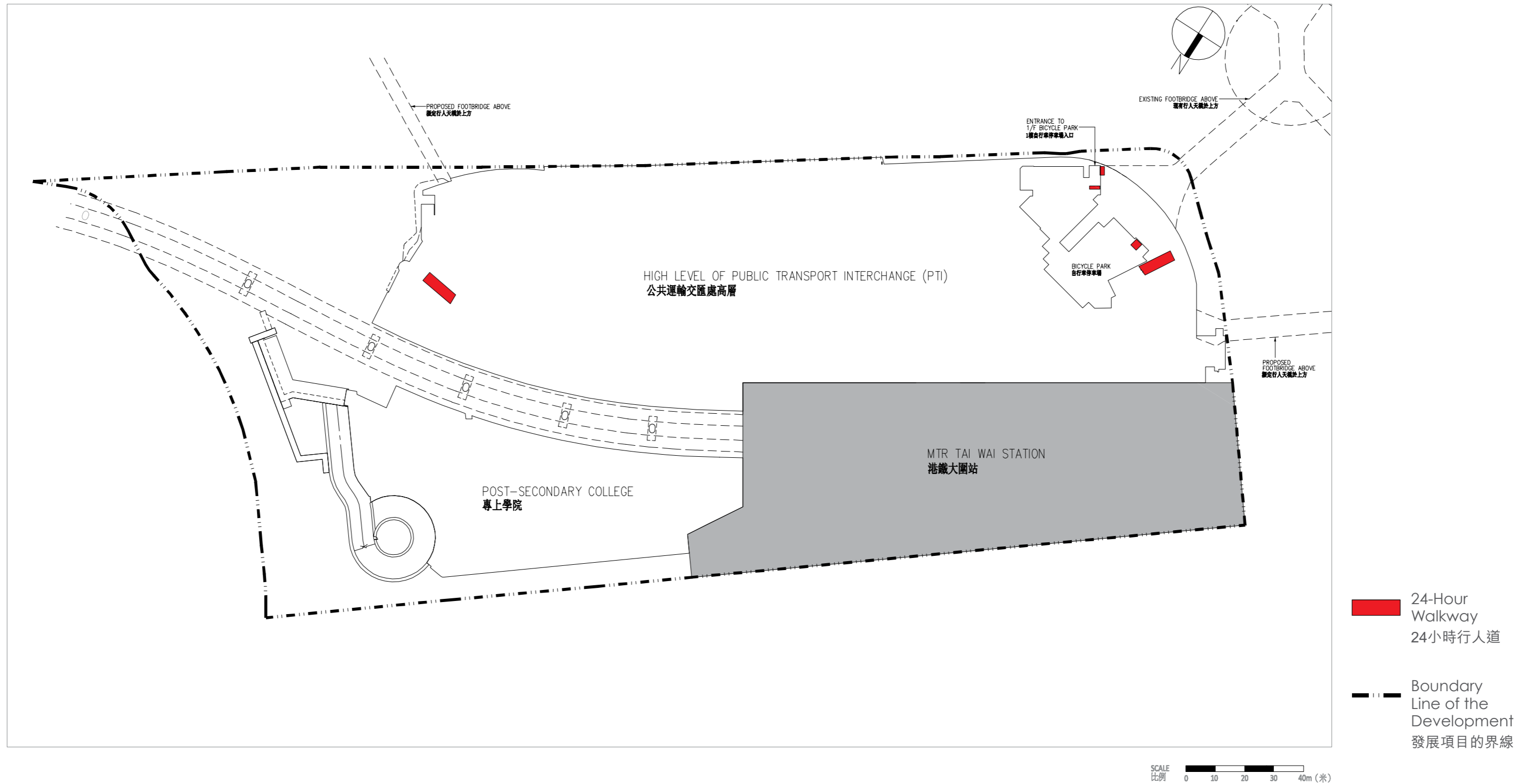

Remark :
The 24-Hour Walkway may not be available for use immediately upon completion of the Phase. Its use and/or operation shall be subject to the issue of consents or approvals by the relevant government authorities, relevant laws, the Land Grant, provisions of the deed of mutual covenants and restrictions of the on-site environment. According to the latest approved building plans, it is estimated that the 24-Hour Walkway shall be completed and open for use upon completion of the commercial portion of the Development.

備註：
24小時行人道在發展項目期數落成時未必能即時使用，其使用及/或運作可能受制於政府有關部門發出之同意書或許可証、相關法律、批地文件、公契條款及現場環境狀況限制。根據最新的經批准的建築圖則，24小時行人道預計將會在發展項目的商業部分落成時完成並開放。

Information on public facilities and public open spaces 公共設施及公眾休憩用地的資料

2/F Floor Plan
2樓樓面平面圖

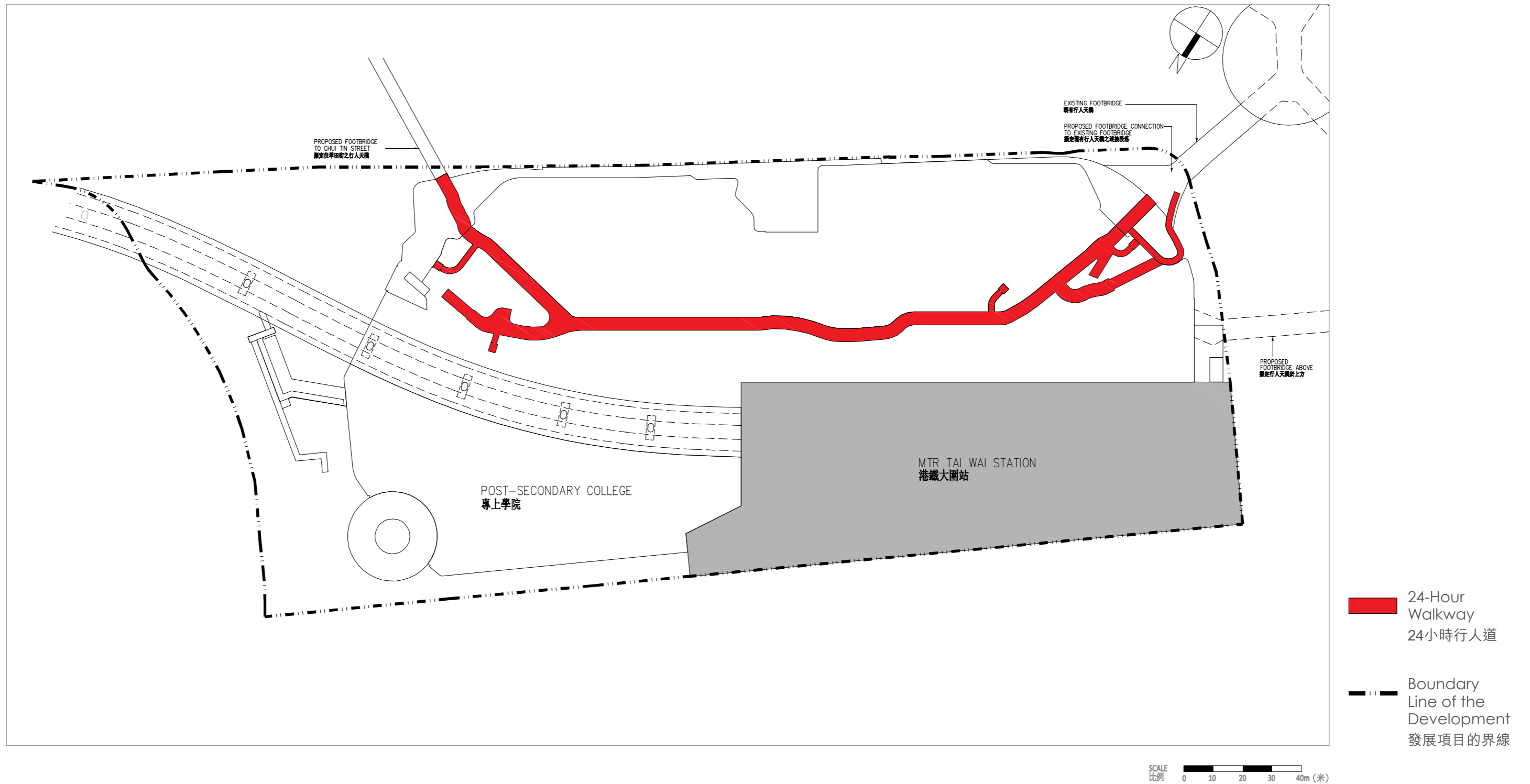

Remark :
The 24-Hour Walkway may not be available for use immediately upon completion of the Phase. Its use and/or operation shall be subject to the issue of consents or approvals by the relevant government authorities, relevant laws, the Land Grant, provisions of the deed of mutual covenants and restrictions of the on-site environment. According to the latest approved building plans, it is estimated that the 24-Hour Walkway shall be completed and open for use upon completion of the commercial portion of the Development.

備註：
24小時行人道在發展項目期數落成時未必能即時使用，其使用及/或運作可能受制於政府有關部門發出之同意書或許可證、相關法律、批地文件、公契條款及現場環境狀況限制。根據最新的經批准的建築圖則，24小時行人道預計將會在發展項目的商業部分落成時完成並開放。

Information on public facilities and public open spaces 公共設施及公眾休憩用地的資料

3/F Floor Plan 3樓樓面平面圖

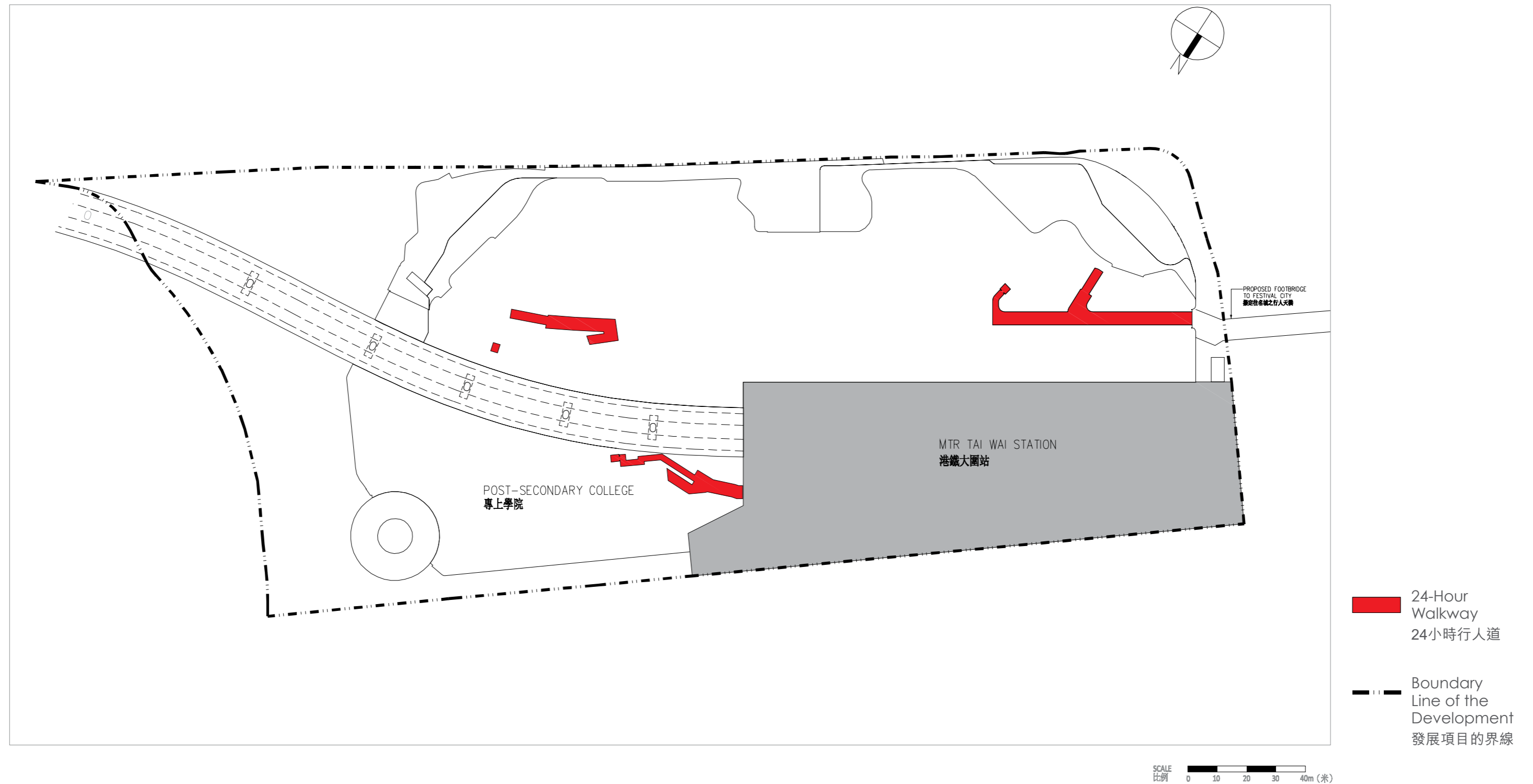

Remark :
The 24-Hour Walkway may not be available for use immediately upon completion of the Phase. Its use and/or operation shall be subject to the issue of consents or approvals by the relevant government authorities, relevant laws, the Land Grant, provisions of the deed of mutual covenants and restrictions of the on-site environment. According to the latest approved building plans, it is estimated that the 24-Hour Walkway shall be completed and open for use upon completion of the commercial portion of the Development.

備註：
24小時行人道在發展項目期數落成時未必能即時使用，其使用及/或運作可能受制於政府有關部門發出之同意書或許可証、相關法律、批地文件、公契條款及現場環境狀況限制。根據最新的經批准的建築圖則，24小時行人道預計將會在發展項目的商業部分落成時完成並開放。

Information on public facilities and public open spaces 公共設施及公眾休憩用地的資料

4/F Floor Plan
4樓樓面平面圖



Remark :
The 24-Hour Walkway may not be available for use immediately upon completion of the Phase. Its use and/or operation shall be subject to the issue of consents or approvals by the relevant government authorities, relevant laws, the Land Grant, provisions of the deed of mutual covenants and restrictions of the on-site environment. According to the latest approved building plans, it is estimated that the 24-Hour Walkway shall be completed and open for use upon completion of the commercial portion of the Development.

備註：
24小時行人道在發展項目期數落成時未必能即時使用，其使用及/或運作可能受制於政府有關部門發出之同意書或許可証、相關法律、批地文件、公契條款及現場環境狀況限制。根據最新的經批准的建築圖則，24小時行人道預計將會在發展項目的商業部分落成時完成並開放。

Warning to purchasers 對買方的警告

- (a) The purchaser is recommended to instruct a separate firm of solicitors (other than that acting for the owner) to act for the purchaser in relation to the transaction.
 - (b) If the purchaser instructs such separate firm of solicitors to act for the purchaser in relation to the transaction, that firm will be able to give independent advice to the purchaser.
 - (c) If the purchaser instructs the firm of solicitors acting for the owner to act for the purchaser as well, and a conflict of interest arises between the owner and the purchaser -
 - (i) that firm may not be able to protect the purchaser's interests ; and
 - (ii) the purchaser may have to instruct a separate firm of solicitors.
 - (d) In the case of paragraph (c)(ii), the total solicitors' fees payable by the purchaser may be higher than the fees that would have been payable if the purchaser had instructed a separate firm of solicitors in the first place.
- (a) 現建議買方聘用一間獨立的律師事務所（代表擁有人行事者除外），以在交易中代表買方行事。
 - (b) 如買方聘用上述的獨立的律師事務所，以在交易中代表買方行事，該律師事務所將會能夠向買方提供獨立意見。
 - (c) 如買方聘用代表擁有人行事的律師事務所同時代表買方行事，而擁有人與買方之間出現利益衝突 -
 - (i) 該律師事務所可能不能夠保障買方的利益；及
 - (ii) 買方可能要聘用一間獨立的律師事務所。
 - (d) 如屬(c)(ii)段的情況，買方須支付的律師費用總數，可能高於如買方自一開始即聘用一間獨立的律師事務所便須支付的費用。

Cross-section plan of building in the phase 期數中的建築物的橫截面圖

Cross-Section Plan A-A
橫截面圖 A-A

- Dotted line denotes the level of the lowest residential floor
虛線為最低住宅樓層水平
- ▽ Height above the Hong Kong Principal Datum (PD) (Metre)
香港主水平基準以上高度(米)
- E&M ROOM Electrical & Mechanical Plant Room
機電房

Remark : This cross-section plan is not drawn to scale
備註：此橫截面圖並非按照比例繪圖

The part of Mei Tin Road adjacent to the building is 5.68 to 6.87 metres above the Hong Kong Principal Datum.
毗連建築物的一段美田路為香港主水平基準以上5.68至6.87米。

Tower 7 第7座

Tower 6 第6座

Tower 5 第5座

Key Plan
索引圖

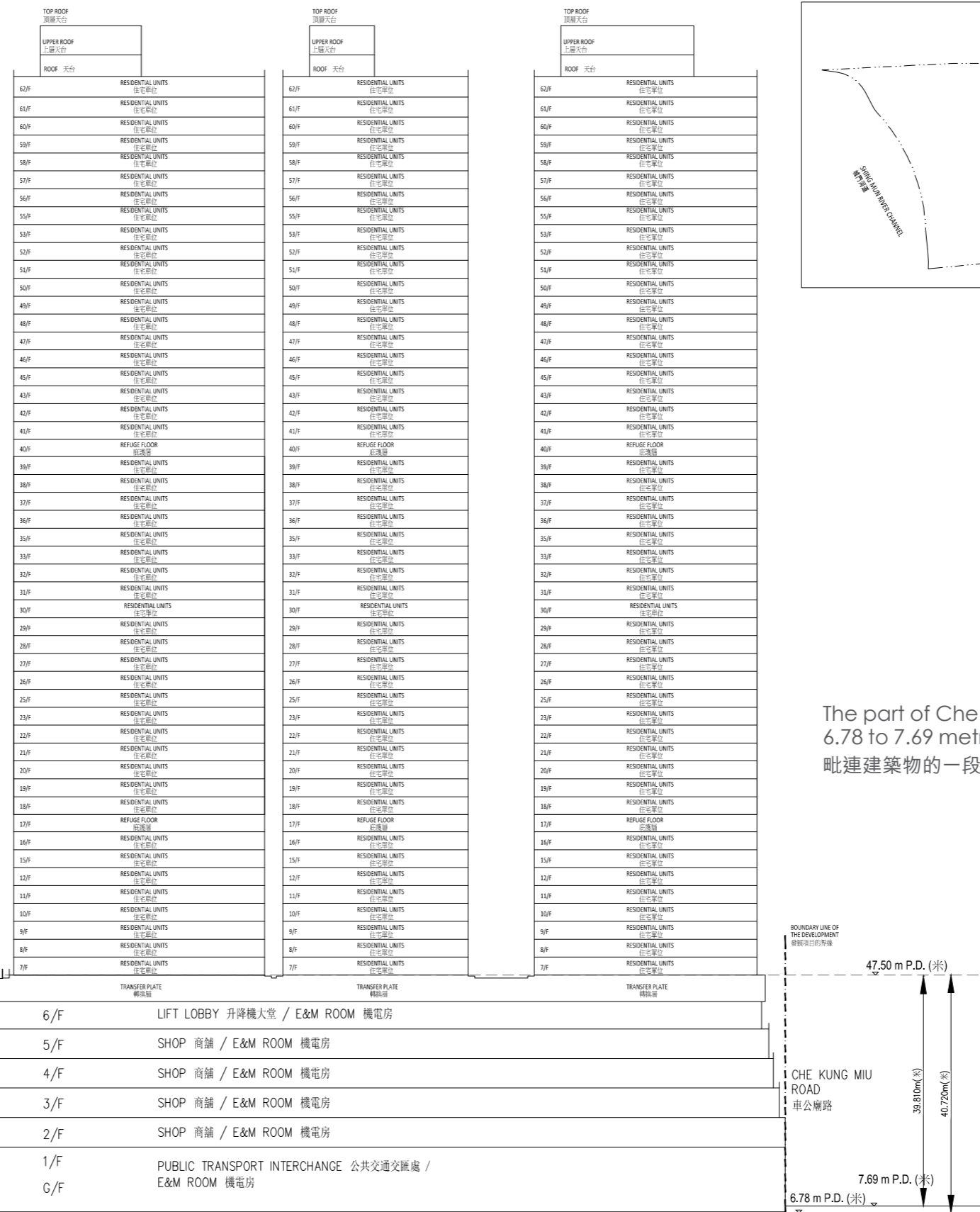
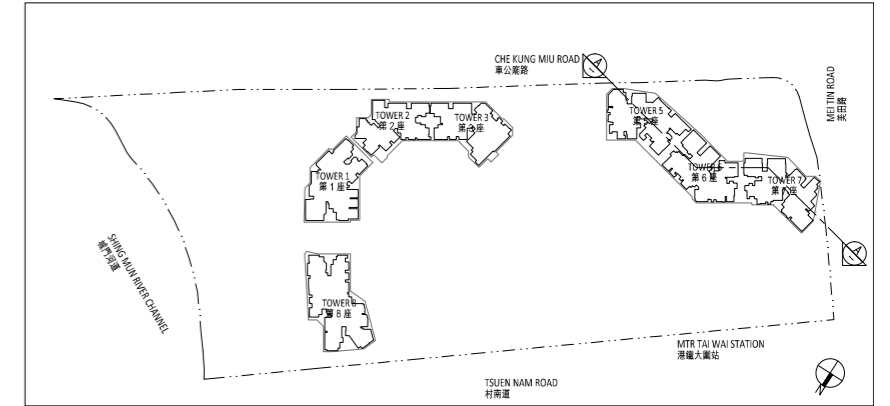

The part of Che Kung Miu Road adjacent to the building is 6.78 to 7.69 metres above the Hong Kong Principal Datum.
毗連建築物的一段車公廟路為香港主水平基準以上6.78至7.69米。

Cross-section plan of building in the phase 期數中的建築物的橫截面圖

Cross-Section Plan B-B
橫截面圖 B-B

- Dotted line denotes the level of the lowest residential floor
虛線為最低住宅樓層水平
- ▽ Height above the Hong Kong Principal Datum (PD) (Metre)
香港主水平基準以上高度(米)
- E&M ROOM Electrical & Mechanical Plant Room
機電房

Remark : This cross-section plan is not drawn to scale
備註：此橫截面圖並非按照比例繪圖

The part of Che Kung Miu Road adjacent to the building is 6.78 to 7.69 metres above the Hong Kong Principal Datum.
毗連建築物的一段車公廟路為香港主水平基準以上6.78至7.69米。

Tower 5 第5座

TOP ROOF	頂層天台
UPPER ROOF	上層天台
ROOF	天台
62/F	RESIDENTIAL UNITS 住宅單位
61/F	RESIDENTIAL UNITS 住宅單位
60/F	RESIDENTIAL UNITS 住宅單位
59/F	RESIDENTIAL UNITS 住宅單位
58/F	RESIDENTIAL UNITS 住宅單位
57/F	RESIDENTIAL UNITS 住宅單位
56/F	RESIDENTIAL UNITS 住宅單位
55/F	RESIDENTIAL UNITS 住宅單位
53/F	RESIDENTIAL UNITS 住宅單位
52/F	RESIDENTIAL UNITS 住宅單位
51/F	RESIDENTIAL UNITS 住宅單位
50/F	RESIDENTIAL UNITS 住宅單位
49/F	RESIDENTIAL UNITS 住宅單位
48/F	RESIDENTIAL UNITS 住宅單位
47/F	RESIDENTIAL UNITS 住宅單位
46/F	RESIDENTIAL UNITS 住宅單位
45/F	RESIDENTIAL UNITS 住宅單位
43/F	RESIDENTIAL UNITS 住宅單位
42/F	RESIDENTIAL UNITS 住宅單位
41/F	RESIDENTIAL UNITS 住宅單位
40/F	REFUGE FLOOR 避難層
39/F	RESIDENTIAL UNITS 住宅單位
38/F	RESIDENTIAL UNITS 住宅單位
37/F	RESIDENTIAL UNITS 住宅單位
36/F	RESIDENTIAL UNITS 住宅單位
35/F	RESIDENTIAL UNITS 住宅單位
33/F	RESIDENTIAL UNITS 住宅單位
32/F	RESIDENTIAL UNITS 住宅單位
31/F	RESIDENTIAL UNITS 住宅單位
30/F	RESIDENTIAL UNITS 住宅單位
29/F	RESIDENTIAL UNITS 住宅單位
28/F	RESIDENTIAL UNITS 住宅單位
27/F	RESIDENTIAL UNITS 住宅單位
26/F	RESIDENTIAL UNITS 住宅單位
25/F	RESIDENTIAL UNITS 住宅單位
23/F	RESIDENTIAL UNITS 住宅單位
22/F	RESIDENTIAL UNITS 住宅單位
21/F	RESIDENTIAL UNITS 住宅單位
20/F	RESIDENTIAL UNITS 住宅單位
19/F	RESIDENTIAL UNITS 住宅單位
18/F	RESIDENTIAL UNITS 住宅單位
17/F	REFUGE FLOOR 避難層
16/F	RESIDENTIAL UNITS 住宅單位
15/F	RESIDENTIAL UNITS 住宅單位
12/F	RESIDENTIAL UNITS 住宅單位
11/F	RESIDENTIAL UNITS 住宅單位
10/F	RESIDENTIAL UNITS 住宅單位
9/F	RESIDENTIAL UNITS 住宅單位
8/F	RESIDENTIAL UNITS 住宅單位
7/F	RESIDENTIAL UNITS 住宅單位

Key Plan
索引圖

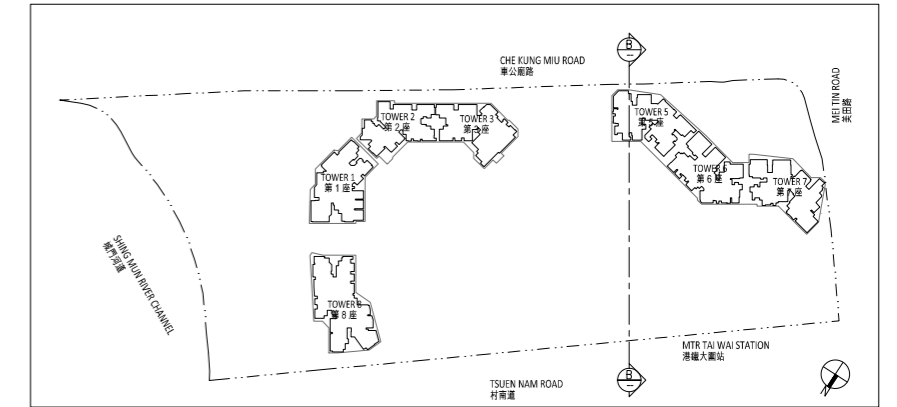

The part of Emergency Vehicular Access / Driveway adjacent to the building is 38.15 metres above the Hong Kong Principal Datum.
毗連建築物的一段緊急車輛通道/行車通道為香港主水平基準以上38.15米。

The part of Tsuen Nam Road adjacent to the building is 3.75 to 6.01 metres above the Hong Kong Principal Datum.
毗連建築物的一段村南道為香港主水平基準以上3.75至6.01米。

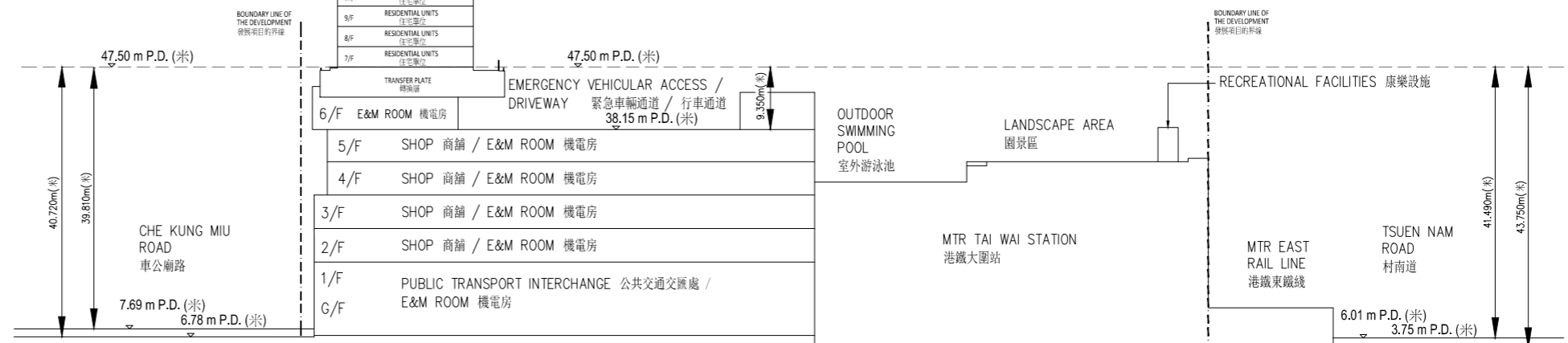

Cross-section plan of building in the phase 期數中的建築物的橫截面圖

Cross-Section Plan C-C
橫截面圖 C-C

- Dotted line denotes the level of the lowest residential floor
虛線為最低住宅樓層水平
- ▽ Height above the Hong Kong Principal Datum (PD) (Metre)
香港主水平基準以上高度(米)
- E&M ROOM Electrical & Mechanical Plant Room
機電房

Remark : This cross-section plan is not drawn to scale
備註：此橫截面圖並非按照比例繪圖

The part of Che Kung Miu Road adjacent to the building is 6.78 to 7.69 metres above the Hong Kong Principal Datum.
毗連建築物的一段車公廟路為香港主水平基準以上6.78至7.69米。

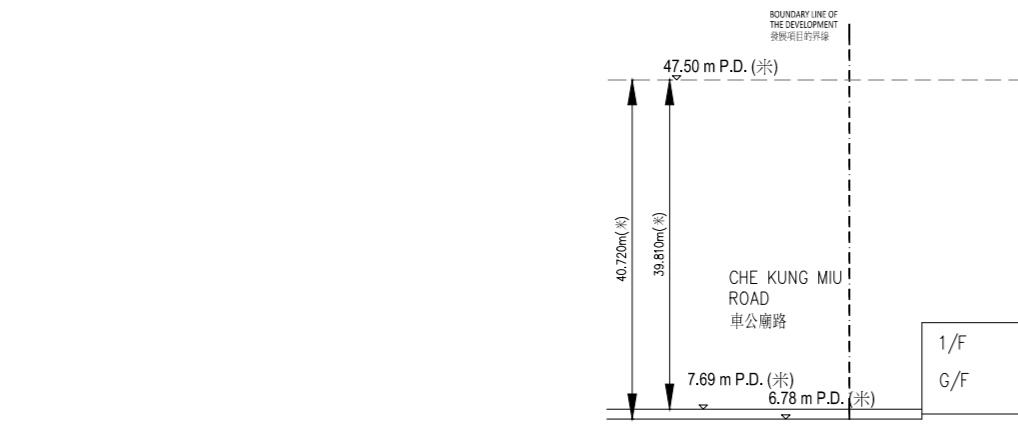

Tower 6 第6座

TOP ROOF	頂層天台
UPPER ROOF	上層天台
ROOF	天台
62/F	RESIDENTIAL UNITS 住宅單位
61/F	RESIDENTIAL UNITS 住宅單位
60/F	RESIDENTIAL UNITS 住宅單位
59/F	RESIDENTIAL UNITS 住宅單位
58/F	RESIDENTIAL UNITS 住宅單位
57/F	RESIDENTIAL UNITS 住宅單位
56/F	RESIDENTIAL UNITS 住宅單位
55/F	RESIDENTIAL UNITS 住宅單位
53/F	RESIDENTIAL UNITS 住宅單位
52/F	RESIDENTIAL UNITS 住宅單位
51/F	RESIDENTIAL UNITS 住宅單位
50/F	RESIDENTIAL UNITS 住宅單位
49/F	RESIDENTIAL UNITS 住宅單位
48/F	RESIDENTIAL UNITS 住宅單位
47/F	RESIDENTIAL UNITS 住宅單位
46/F	RESIDENTIAL UNITS 住宅單位
45/F	RESIDENTIAL UNITS 住宅單位
43/F	RESIDENTIAL UNITS 住宅單位
42/F	RESIDENTIAL UNITS 住宅單位
41/F	RESIDENTIAL UNITS 住宅單位
40/F	REFUGE FLOOR 避難層
39/F	RESIDENTIAL UNITS 住宅單位
38/F	RESIDENTIAL UNITS 住宅單位
37/F	RESIDENTIAL UNITS 住宅單位
36/F	RESIDENTIAL UNITS 住宅單位
35/F	RESIDENTIAL UNITS 住宅單位
33/F	RESIDENTIAL UNITS 住宅單位
32/F	RESIDENTIAL UNITS 住宅單位
31/F	RESIDENTIAL UNITS 住宅單位
30/F	RESIDENTIAL UNITS 住宅單位
29/F	RESIDENTIAL UNITS 住宅單位
28/F	RESIDENTIAL UNITS 住宅單位
27/F	RESIDENTIAL UNITS 住宅單位
26/F	RESIDENTIAL UNITS 住宅單位
25/F	RESIDENTIAL UNITS 住宅單位
23/F	RESIDENTIAL UNITS 住宅單位
22/F	RESIDENTIAL UNITS 住宅單位
21/F	RESIDENTIAL UNITS 住宅單位
20/F	RESIDENTIAL UNITS 住宅單位
19/F	RESIDENTIAL UNITS 住宅單位
18/F	RESIDENTIAL UNITS 住宅單位
17/F	REFUGE FLOOR 避難層
16/F	RESIDENTIAL UNITS 住宅單位
15/F	RESIDENTIAL UNITS 住宅單位
12/F	RESIDENTIAL UNITS 住宅單位
11/F	RESIDENTIAL UNITS 住宅單位
10/F	RESIDENTIAL UNITS 住宅單位
9/F	RESIDENTIAL UNITS 住宅單位
8/F	RESIDENTIAL UNITS 住宅單位
7/F	RESIDENTIAL UNITS 住宅單位

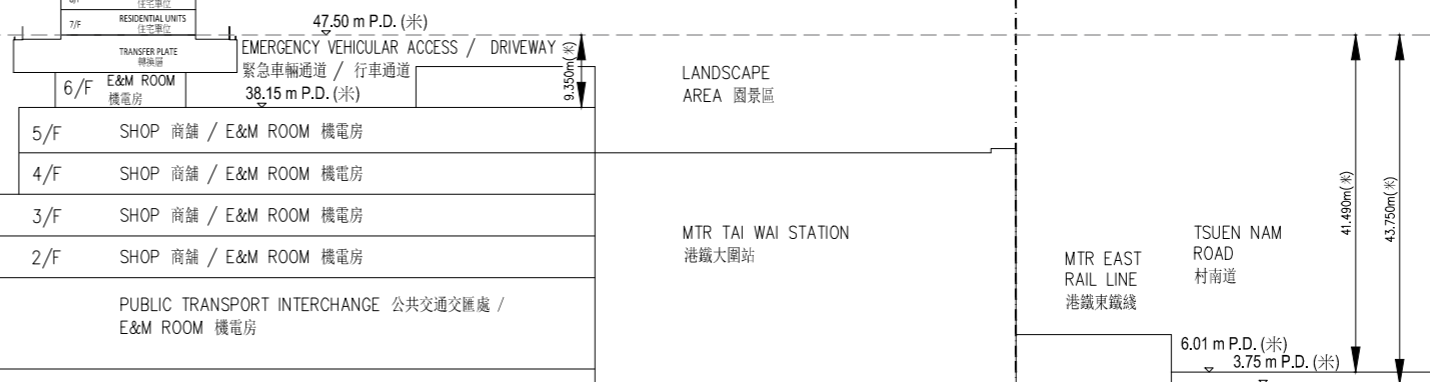

Key Plan
索引圖

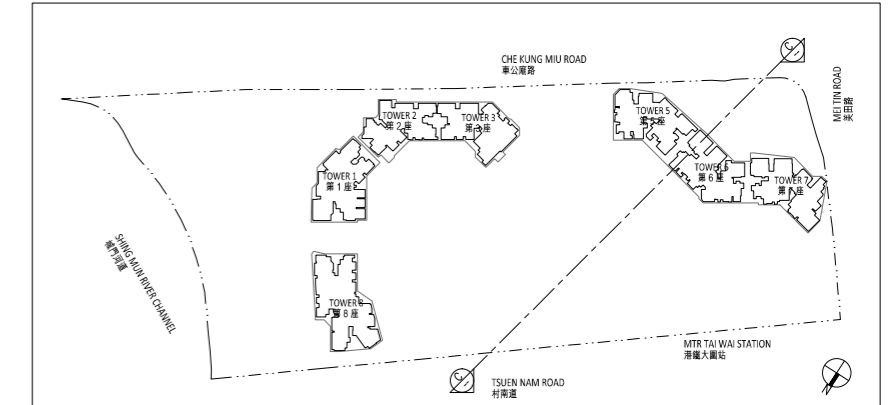

The part of Emergency Vehicular Access / Driveway adjacent to the building is 38.15 metres above the Hong Kong Principal Datum.
毗連建築物的一段緊急車輛通道/行車通道為香港主水平基準以上38.15米。

The part of Tsuen Nam Road adjacent to the building is 3.75 to 6.01 metres above the Hong Kong Principal Datum.
毗連建築物的一段村南道為香港主水平基準以上3.75至6.01米。

Cross-section plan of building in the phase 期數中的建築物的橫截面圖

Cross-Section Plan D-D
橫截面圖 D-D

- Dotted line denotes the level of the lowest residential floor
虛線為最低住宅樓層水平
- ▽ Height above the Hong Kong Principal Datum (PD) (Metre)
香港主水平基準以上高度(米)
- E&M ROOM Electrical & Mechanical Plant Room
機電房

Remark : This cross-section plan is not drawn to scale
備註：此橫截面圖並非按照比例繪圖

The part of Mei Tin Road adjacent to the building is 5.68 to 6.87 metres above the Hong Kong Principal Datum.
毗連建築物的一段美田路為香港主水平基準以上5.68至6.87米。

The part of the Footbridge adjacent to the building is 25.52 metres above the Hong Kong Principal Datum.
毗連建築物的一段行人天橋為香港主水平基準以上25.52米。

Tower 7 第7座

TOP ROOF	頂層天台
UPPER ROOF	上層天台
ROOF	天台
62/F	RESIDENTIAL UNITS 住宅單位
61/F	RESIDENTIAL UNITS 住宅單位
60/F	RESIDENTIAL UNITS 住宅單位
59/F	RESIDENTIAL UNITS 住宅單位
58/F	RESIDENTIAL UNITS 住宅單位
57/F	RESIDENTIAL UNITS 住宅單位
56/F	RESIDENTIAL UNITS 住宅單位
55/F	RESIDENTIAL UNITS 住宅單位
53/F	RESIDENTIAL UNITS 住宅單位
52/F	RESIDENTIAL UNITS 住宅單位
51/F	RESIDENTIAL UNITS 住宅單位
50/F	RESIDENTIAL UNITS 住宅單位
49/F	RESIDENTIAL UNITS 住宅單位
48/F	RESIDENTIAL UNITS 住宅單位
47/F	RESIDENTIAL UNITS 住宅單位
46/F	RESIDENTIAL UNITS 住宅單位
45/F	RESIDENTIAL UNITS 住宅單位
43/F	RESIDENTIAL UNITS 住宅單位
42/F	RESIDENTIAL UNITS 住宅單位
41/F	RESIDENTIAL UNITS 住宅單位
40/F	REFUGE FLOOR 避難層
39/F	RESIDENTIAL UNITS 住宅單位
38/F	RESIDENTIAL UNITS 住宅單位
37/F	RESIDENTIAL UNITS 住宅單位
36/F	RESIDENTIAL UNITS 住宅單位
35/F	RESIDENTIAL UNITS 住宅單位
33/F	RESIDENTIAL UNITS 住宅單位
32/F	RESIDENTIAL UNITS 住宅單位
31/F	RESIDENTIAL UNITS 住宅單位
30/F	RESIDENTIAL UNITS 住宅單位
29/F	RESIDENTIAL UNITS 住宅單位
28/F	RESIDENTIAL UNITS 住宅單位
27/F	RESIDENTIAL UNITS 住宅單位
26/F	RESIDENTIAL UNITS 住宅單位
25/F	RESIDENTIAL UNITS 住宅單位
23/F	RESIDENTIAL UNITS 住宅單位
22/F	RESIDENTIAL UNITS 住宅單位
21/F	RESIDENTIAL UNITS 住宅單位
20/F	RESIDENTIAL UNITS 住宅單位
19/F	RESIDENTIAL UNITS 住宅單位
18/F	RESIDENTIAL UNITS 住宅單位
17/F	REFUGE FLOOR 避難層
16/F	RESIDENTIAL UNITS 住宅單位
15/F	RESIDENTIAL UNITS 住宅單位
12/F	RESIDENTIAL UNITS 住宅單位
11/F	RESIDENTIAL UNITS 住宅單位
10/F	RESIDENTIAL UNITS 住宅單位
9/F	RESIDENTIAL UNITS 住宅單位
8/F	RESIDENTIAL UNITS 住宅單位
7/F	RESIDENTIAL UNITS 住宅單位

Key Plan
索引圖

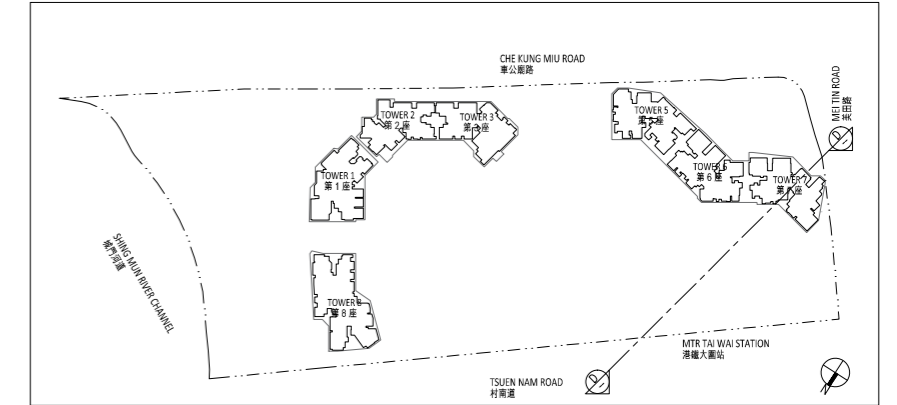

The part of Emergency Vehicular Access / Driveway adjacent to the building is 38.15 metres above the Hong Kong Principal Datum.
毗連建築物的一段緊急車輛通道/行車通道為香港主水平基準以上38.15米。

The part of Tsuen Nam Road adjacent to the building is 3.75 to 6.01 metres above the Hong Kong Principal Datum.
毗連建築物的一段村南道為香港主水平基準以上3.75至6.01米。

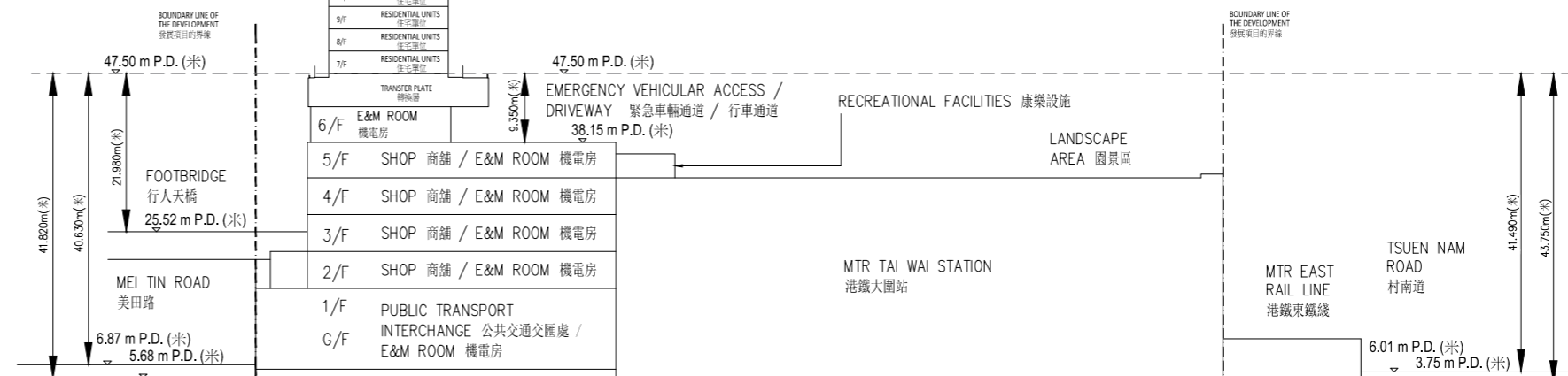

Elevation plan 立面圖

Tower 5 第5座

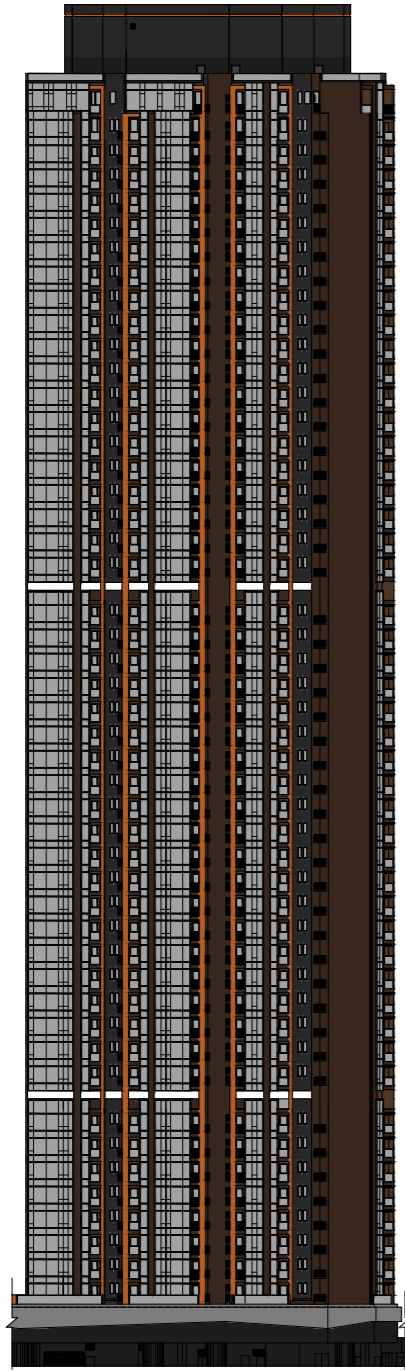

Elevation Plan 1 立面圖1

Tower 5 第5座



Elevation Plan 2 立面圖2

Tower 5 第5座



Elevation Plan 3 立面圖3

Tower 5 第5座

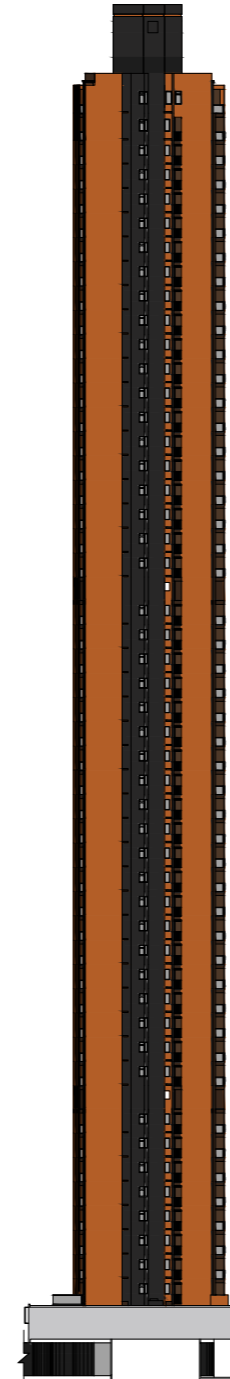

Elevation Plan 4 立面圖4

Key Plan
索引圖

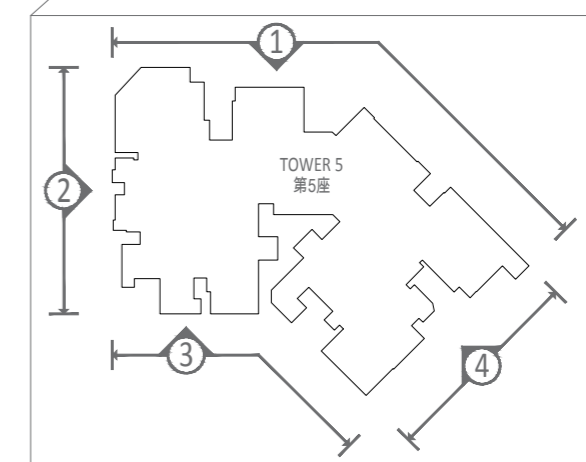
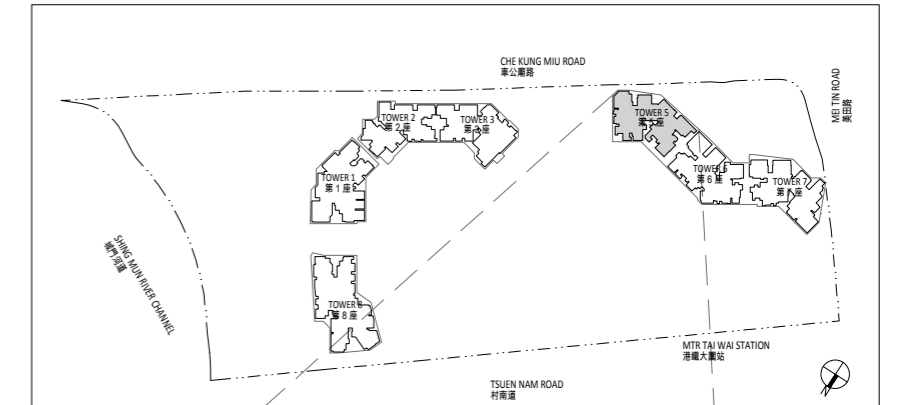

The Authorized Person for the Phase has certified that the elevations shown on these plans:
 1. are prepared on the basis of the approved building plans for the Phase as of 29 April 2020;
 2. are in general accordance with the outward appearance of the Phase.

期數的認可人士已證明本圖所顯示的立面：

1. 以2020年4月29日的情況為準的期數經批准的建築圖則為基礎擬備；
2. 大致上與該期數的外觀一致。

Elevation plan
立面圖

Tower 6 第6座



Elevation Plan 5 立面圖5

Tower 6 第6座

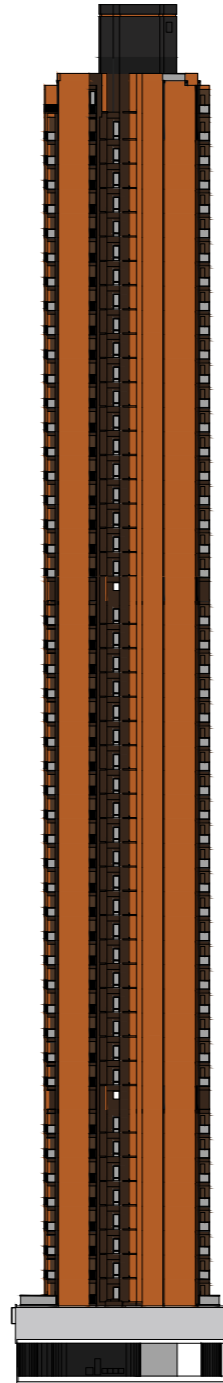

Elevation Plan 6 立面圖6

Tower 6 第6座

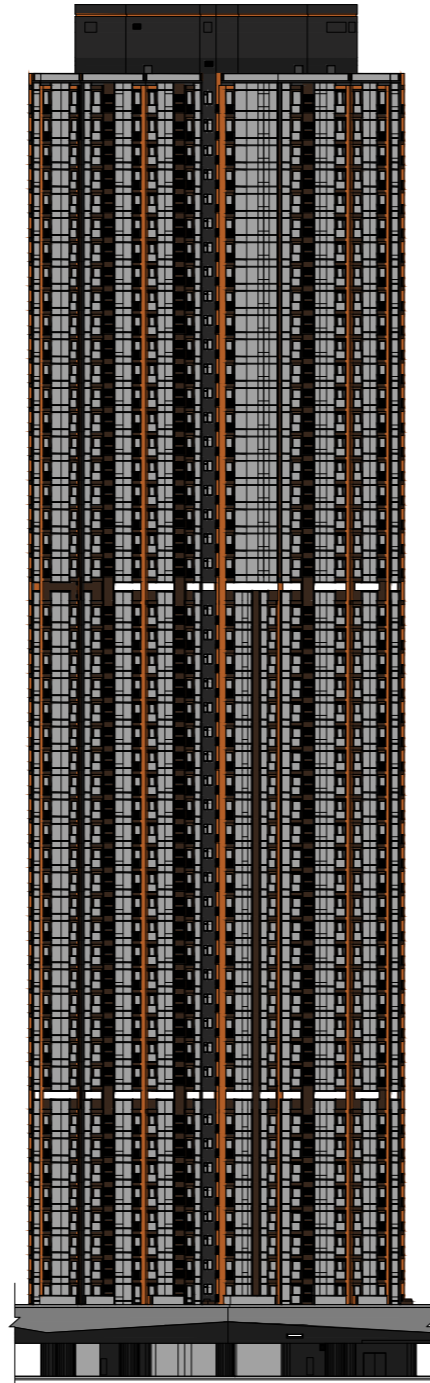

Elevation Plan 7 立面圖7

Tower 6 第6座

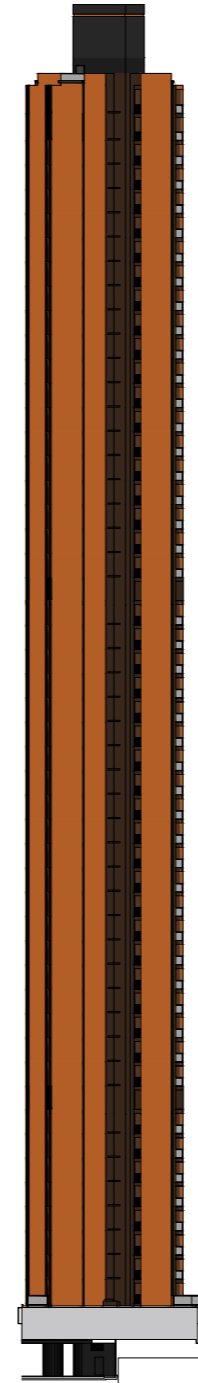

Elevation Plan 8 立面圖8

Key Plan
索引圖

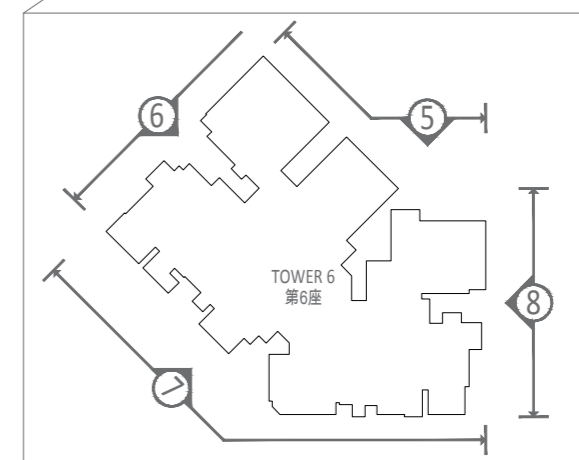
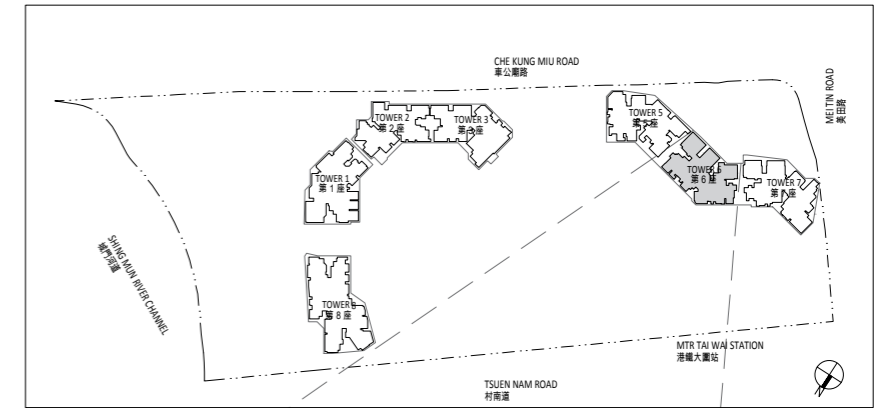

The Authorized Person for the Phase has certified that the elevations shown on these plans:
1. are prepared on the basis of the approved building plans for the Phase as of 29 April 2020;
2. are in general accordance with the outward appearance of the Phase.

期數的認可人士已證明本圖所顯示的立面：
1. 以2020年4月29日的情況為準的期數經批准的建築圖則為基礎擬備；
2. 大致上與該期數的外觀一致。

Elevation plan
立面圖

Tower 7 第7座

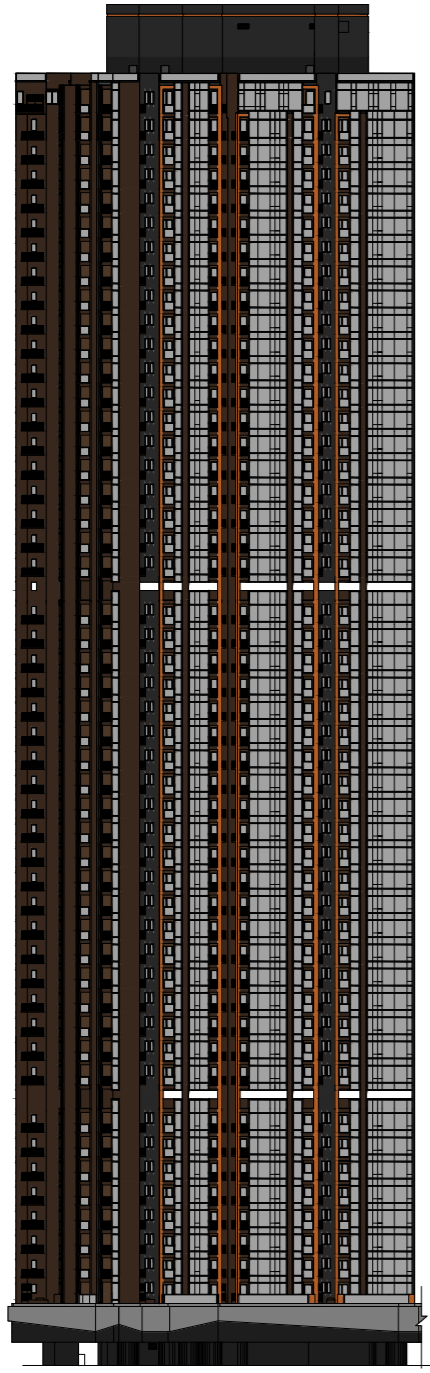

Elevation Plan 9 立面圖9

Tower 7 第7座



Elevation Plan 10 立面圖10

Tower 7 第7座



Elevation Plan 11 立面圖11

Tower 7 第7座



Elevation Plan 12 立面圖12

Key Plan
索引圖

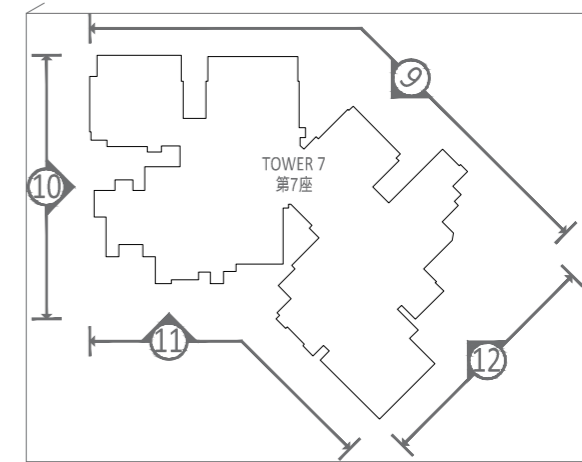
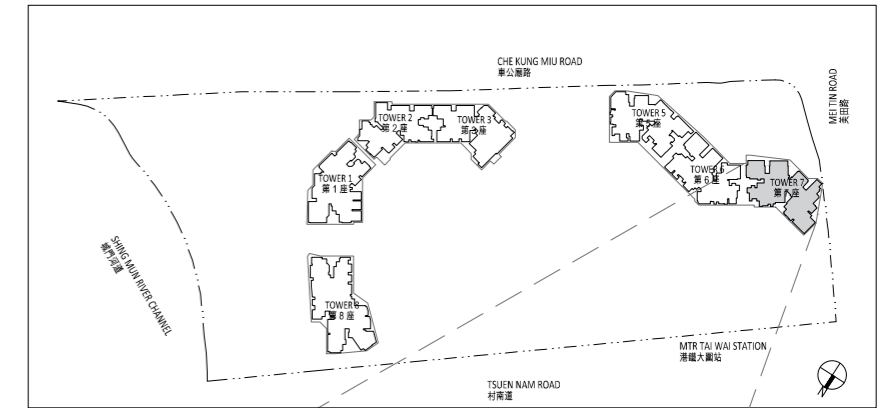

The Authorized Person for the Phase has certified that the elevations shown on these plans:
1. are prepared on the basis of the approved building plans for the Phase as of 29 April 2020;
2. are in general accordance with the outward appearance of the Phase.

期數的認可人士已證明本圖所顯示的立面：

1. 以2020年4月29日的情況為準的期數經批准的建築圖則為基礎擬備；
2. 大致上與該期數的外觀一致。

Elevation plan
立面圖

Key Plan
索引圖

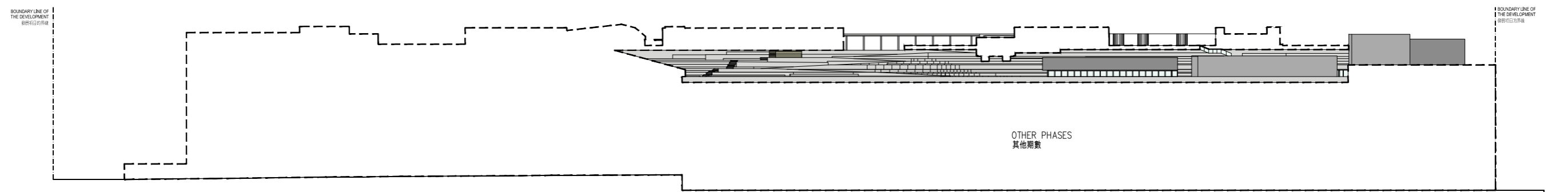
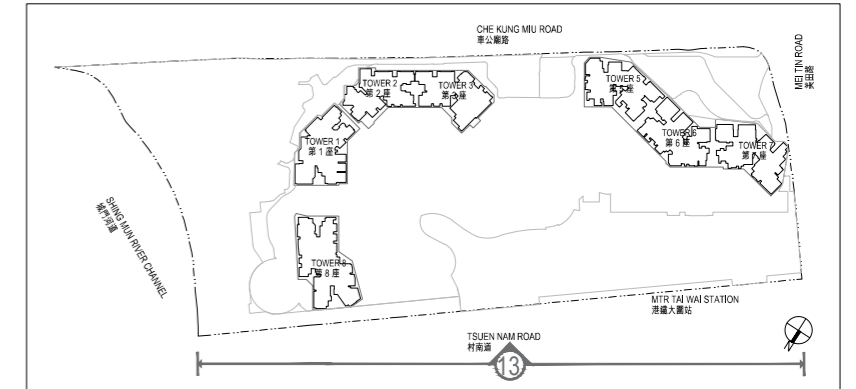

Elevation Plan 13 立面圖13

The Authorized Person for the Phase has certified that the elevations shown on these plans:
1. are prepared on the basis of the approved building plans for the Phase as of 29 April 2020;
2. are in general accordance with the outward appearance of the Phase.

期數的認可人士已證明本圖所顯示的立面：

1. 以2020年4月29日的情況為準的期數經批准的建築圖則為基礎擬備；
2. 大致上與該期數的外觀一致。

Information on common facilities in the phase
期數中的公用設施的資料

Common Facilities 公用設施		Area 面積		Total Area 總面積	
		sq. m. 平方米	sq. ft. 平方呎	sq. m. 平方米	sq. ft. 平方呎
Residents' clubhouse (including any recreational facilities for residents' use) 住客會所 (包括供住客使用的任何康樂設施)	Covered 有上蓋	1,151.072	12,390	2,860.483	30,790
	Uncovered 沒有上蓋	1,709.411	18,400		
Communal garden or play area for residents' use on the roof, or on any floor between the roof and the lowest residential floor, of a building in the Phase (whether known as a communal sky garden or otherwise) 位於期數中的建築物的天台或在天台和最低一層住宅樓層之間的任何一層的、供住客使用的公用花園或遊樂地方 (不論是稱為公用空中花園或有其他名稱)	Covered 有上蓋	-	-	-	-
	Uncovered 沒有上蓋	-	-		
Communal garden or play area for residents' use below the lowest residential floor of a building in the Phase (whether known as a covered and landscaped play area or otherwise) 位於期數中的建築物的最低一層住宅樓層以下的、供住客使用的公用花園或遊樂地方 (不論是稱為有蓋及園景的遊樂場或有其他名稱)	Covered 有上蓋	1,166.141	12,552	9,677.834	104,172
	Uncovered 沒有上蓋	8,511.693	91,620		

- Remarks :
- Areas in square metres as specified above are based on the latest approved building plans.
 - Areas in square feet are converted from areas in square metres at a rate of 1 square metre to 10.764 square feet and rounded off to the nearest integer.
- 備註：
- 上述所列以平方米顯示之面積乃依據最新的經批准的建築圖則。
 - 以平方呎顯示之面積由以平方米顯示之面積以1平方米=10.764平方呎換算，並四捨五入至整數。

Inspection of plans and deed of mutual covenant

閱覽圖則及公契

1. The address of the website on which a copy of the outline zoning plan relating to the Development is available:
www.ozp.tpb.gov.hk
 2. (a) A copy of the latest draft of every deed of mutual covenant in respect of the specified residential properties as at the date on which the specified residential properties are offered to be sold is available for inspection at the place at which the specified residential properties are offered to be sold.
(b) The inspection is free of charge.
1. 備有關於本發展項目的分區計劃大綱圖的文本供閱覽的互聯網網站的網址為 www.ozp.tpb.gov.hk
 2. (a) 指明住宅物業的每一公契在將指明住宅物業提供出售的日期的最新擬稿的文本存放在指明住宅物業的售樓處，以供閱覽。
(b) 無須為閱覽付費。

Fittings, finishes and appliances

裝置、裝修物料及設備

1. Exterior Finishes	
Item	Description
(a) External wall	Finished with aluminium framed curtain wall, tiles, aluminium cladding, metal louvre, metal grille, metal balustrade, glass balustrade and paint.
(b) Window	<p>- Aluminium window frames fitted with insulated-glass-unit (IGU) with low-emissivity coating for living room, master bedroom and bedroom in the following residential properties:</p> <ul style="list-style-type: none"> (i) Flat A, 62/F, Tower 5 (5A) (Living Room, Bedroom 1, Bedroom 2 and Master Bedroom) (ii) Flat B, 62/F, Tower 5 (5A) (Bedroom 1) (iii) Flat D, 62/F, Tower 5 (5A) (Bedroom 1) (iv) Flat E, 62/F, Tower 5 (5A) (Bedroom 1) (v) Flat A, 62/F, Tower 5 (5B) (Living Room, Bedroom 1, Bedroom 2, Bedroom 3 and Master Bedroom) (vi) Flat C, 62/F, Tower 5 (5B) (Bedroom 1) (vii) Flat D, 62/F, Tower 5 (5B) (Bedroom 1) (viii) Flat A, 62/F, Tower 6 (6A) (Living Room, Bedroom 1, Bedroom 2, Bedroom 3 and Master Bedroom) (ix) Flat C, 62/F, Tower 6 (6A) (Bedroom 1) (x) Flat D, 62/F, Tower 6 (6A) (Bedroom 1) (xi) Flat E, 62/F, Tower 6 (6A) (Bedroom 1) (xii) Flat A, 62/F, Tower 6 (6B) (Bedroom 1, Bedroom 2 and Master Bedroom) (xiii) Flat C, 62/F, Tower 6 (6B) (Bedroom 1 and Bedroom 2) (xiv) Flat E, 62/F, Tower 6 (6B) (Master Bedroom) (xv) Flat F, 62/F, Tower 6 (6B) (Bedroom 1) (xvi) Flat A, 62/F, Tower 7 (7A) (Living Room, Bedroom 1, Bedroom 2, Bedroom 3 and Master Bedroom) (xvii) Flat C, 62/F, Tower 7 (7A) (Bedroom 1) (xviii) Flat D, 62/F, Tower 7 (7A) (Master Bedroom) (xix) Flat F, 62/F, Tower 7 (7A) (Master Bedroom) (xx) Flat A, 62/F, Tower 7 (7B) (Bedroom 1, Bedroom 2 and Master Bedroom) (xxi) Flat B, 62/F, Tower 7 (7B) (Bedroom 1) (xxii) Flat C, 62/F, Tower 7 (7B) (Master Bedroom) (xxiii) Flat D, 62/F, Tower 7 (7B) (Bedroom 1, Bedroom 2 and Bedroom 3)

1. 外部裝修物料	
細項	描述
(a) 外牆	鋪砌鋁框幕牆、瓷磚、鋁覆蓋板、金屬百葉、金屬格柵、金屬圍欄、玻璃圍欄及油漆。
(b) 窗	<p>- 以下住宅物業的客廳、主人睡房及睡房選用鋁質窗框配雙層中空玻璃配低輻射鍍膜:</p> <ul style="list-style-type: none"> (i) 第5座 (5A), 62樓A單位 (客廳、睡房1、睡房2及主人睡房) (ii) 第5座 (5A), 62樓B單位 (睡房1) (iii) 第5座 (5A), 62樓D單位 (睡房1) (iv) 第5座 (5A), 62樓E單位 (睡房1) (v) 第5座 (5B), 62樓A單位 (客廳、睡房1、睡房2、睡房3及主人睡房) (vi) 第5座 (5B), 62樓C單位 (睡房1) (vii) 第5座 (5B), 62樓D單位 (睡房1) (viii) 第6座 (6A), 62樓A單位 (客廳、睡房1、睡房2、睡房3及主人睡房) (ix) 第6座 (6A), 62樓C單位 (睡房1) (x) 第6座 (6A), 62樓D單位 (睡房1) (xi) 第6座 (6A), 62樓E單位 (睡房1) (xii) 第6座 (6B), 62樓A單位 (睡房1、睡房2及主人睡房) (xiii) 第6座 (6B), 62樓C單位 (睡房1及睡房2) (xiv) 第6座 (6B), 62樓E單位 (主人睡房) (xv) 第6座 (6B), 62樓F單位 (睡房1) (xvi) 第7座 (7A), 62樓A單位 (客廳、睡房1、睡房2、睡房3及主人睡房) (xvii) 第7座 (7A), 62樓C單位 (睡房1) (xviii) 第7座 (7A), 62樓D單位 (主人睡房) (xix) 第7座 (7A), 62樓F單位 (主人睡房) (xx) 第7座 (7B), 62樓A單位 (睡房1、睡房2及主人睡房) (xxi) 第7座 (7B), 62樓B單位 (睡房1) (xxii) 第7座 (7B), 62樓C單位 (主人睡房) (xxiii) 第7座 (7B), 62樓D單位 (睡房1、睡房2及睡房3)

Fittings, finishes and appliances

裝置、裝修物料及設備

1. Exterior Finishes	
Item	Description
(b) Window	<ul style="list-style-type: none"> - Aluminium window frames fitted with tinted obscured glass for living room, master bedroom and bedroom in the following residential properties: <ul style="list-style-type: none"> (i) Flats B, 7/F to 12/F, 15/F to 16/F, 18/F to 23/F, 25/F to 33/F, 35/F to 39/F, 41/F to 43/F, 45/F to 53/F & 55/F to 62/F, Tower 5 (5A) (Master Bedroom) (ii) Flats C, 7/F to 12/F, 15/F to 16/F, 18/F to 23/F, 25/F to 33/F, 35/F to 39/F, 41/F to 43/F, 45/F to 53/F & 55/F to 62/F, Tower 5 (5B) (Master Bedroom) (iii) Flat A, 62/F, Tower 5 (5B) (Living Room) (iv) Flat A, 62/F, Tower 6 (6A) (Living Room) (v) Flat A, 62/F, Tower 7 (7A) (Living Room) (vi) Flats F, 7/F to 12/F, 15/F to 16/F, 18/F to 23/F, 25/F to 33/F, 35/F to 39/F, 41/F to 43/F, 45/F to 53/F & 55/F to 62/F, Tower 7 (7A) (Master Bedroom) (vii) Flat D, 62/F, Tower 7 (7B) (Bedroom 3) (viii) Flats E, 7/F to 12/F, 15/F to 16/F, 18/F to 23/F, 25/F to 33/F, 35/F to 39/F, 41/F to 43/F, 45/F to 53/F & 55/F to 61/F, Tower 7 (7B) (Bedroom 1) - Aluminium window frames fitted with tinted glass for master bedroom and bedroom in the following residential properties: <ul style="list-style-type: none"> (i) Flat F, 7/F to 12/F, 15/F to 16/F, 18/F to 23/F, 25/F to 33/F, 35/F to 39/F, 41/F to 43/F, 45/F to 53/F & 55/F to 61/F, Tower 7 (7A) (Master Bedroom) (ii) Flat C, 7/F to 12/F, 15/F to 16/F, 18/F to 23/F, 25/F to 33/F, 35/F to 39/F, 41/F to 43/F, 45/F to 53/F & 55/F to 62/F, Tower 7 (7B) (Master Bedroom) (iii) Flat E, 7/F to 12/F, 15/F to 16/F, 18/F to 23/F, 25/F to 33/F, 35/F to 39/F, 41/F to 43/F, 45/F to 53/F & 55/F to 61/F, Tower 7 (7B) (Bedroom 1) - Aluminium window frames fitted with tinted glass for living room, master bedroom and bedroom in the other residential properties. - Aluminium window frame fitted with tinted obscured glass for dining room of the following residential properties: <ul style="list-style-type: none"> (i) Flats B, 7/F to 12/F, 15/F to 16/F, 18/F to 23/F, 25/F to 33/F, 35/F to 39/F, 41/F to 43/F, 45/F to 53/F & 55/F to 61/F, Tower 5 (5B) (ii) Flats C, 7/F to 12/F, 15/F to 16/F, 18/F to 23/F, 25/F to 33/F, 35/F to 39/F, 41/F to 43/F, 45/F to 53/F & 55/F to 62/F, Tower 5 (5B) (iii) Flats D, 7/F to 12/F, 15/F to 16/F, 18/F to 23/F, 25/F to 33/F, 35/F to 39/F, 41/F to 43/F, 45/F to 53/F & 55/F to 62/F, Tower 5 (5B) (iv) Flats A, 7/F to 12/F, 15/F to 16/F, 18/F to 23/F, 25/F to 33/F, 35/F to 39/F, 41/F to 43/F, 45/F to 53/F & 55/F to 61/F, Tower 6 (6A) (v) Flats A, 7/F to 12/F, 15/F to 16/F, 18/F to 23/F, 25/F to 33/F, 35/F to 39/F, 41/F to 43/F, 45/F to 53/F & 55/F to 61/F, Tower 7 (7A)

1. 外部裝修物料	
細項	描述
(b) 窗	<ul style="list-style-type: none"> - 以下住宅物業的客廳、主人睡房及睡房選用鋁質窗框配有色磨砂玻璃: <ul style="list-style-type: none"> (i) 第5座 (5A), 7樓至12樓、15樓至16樓、18樓至23樓、25樓至33樓、35樓至39樓、41樓至43樓、45樓至53樓及55樓至62樓B單位 (主人睡房) (ii) 第5座 (5B), 7樓至12樓、15樓至16樓、18樓至23樓、25樓至33樓、35樓至39樓、41樓至43樓、45樓至53樓及55樓至62樓C單位 (主人睡房) (iii) 第5座 (5B), 62樓A單位 (客廳) (iv) 第6座 (6A), 62樓A單位 (客廳) (v) 第7座 (7A), 62樓A單位 (客廳) (vi) 第7座 (7A), 7樓至12樓、15樓至16樓、18樓至23樓、25樓至33樓、35樓至39樓、41樓至43樓、45樓至53樓及55樓至62樓F單位 (主人睡房) (vii) 第7座 (7B), 62樓D單位 (睡房3) (viii) 第7座 (7B), 7樓至12樓、15樓至16樓、18樓至23樓、25樓至33樓、35樓至39樓、41樓至43樓、45樓至53樓及55樓至61樓E單位 (睡房1) - 以下住宅物業的主人睡房及睡房選用鋁質窗框配有色玻璃: <ul style="list-style-type: none"> (i) 第7座(7A), 7樓至12樓、15樓至16樓、18樓至23樓、25樓至33樓、35樓至39樓、41樓至43樓、45樓至53樓及55樓至61樓F單位 (主人睡房) (ii) 第7座(7B), 7樓至12樓、15樓至16樓、18樓至23樓、25樓至33樓、35樓至39樓、41樓至43樓、45樓至53樓及55樓至62樓C單位 (主人睡房) (iii) 第7座(7B), 7樓至12樓、15樓至16樓、18樓至23樓、25樓至33樓、35樓至39樓、41樓至43樓、45樓至53樓及55樓至61樓E單位 (睡房1) - 其他物業客廳、主人睡房及睡房選用鋁質窗框配有色玻璃。 - 以下住宅物業的飯廳選用鋁質框配有色磨砂玻璃: <ul style="list-style-type: none"> (i) 第5座 (5B), 7樓至12樓、15樓至16樓、18樓至23樓、25樓至33樓、35樓至39樓、41樓至43樓、45樓至53樓及55樓至61樓B單位 (ii) 第5座 (5B), 7樓至12樓、15樓至16樓、18樓至23樓、25樓至33樓、35樓至39樓、41樓至43樓、45樓至53樓及55樓至62樓C單位 (iii) 第5座 (5B), 7樓至12樓、15樓至16樓、18樓至23樓、25樓至33樓、35樓至39樓、41樓至43樓、45樓至53樓及55樓至62樓D單位 (iv) 第6座 (6A), 7樓至12樓、15樓至16樓、18樓至23樓、25樓至33樓、35樓至39樓、41樓至43樓、45樓至53樓及55樓至61樓A單位 (v) 第7座 (7A), 7樓至12樓、15樓至16樓、18樓至23樓、25樓至33樓、35樓至39樓、41樓至43樓、45樓至53樓及55樓至61樓A單位

Fittings, finishes and appliances

裝置、裝修物料及設備

1. Exterior Finishes	
Item	Description
(b) Window	<ul style="list-style-type: none"> - Aluminium window frame fitted with insulated-glass-unit (IGU) with low-emissivity coating for dining room of the following residential properties: <ul style="list-style-type: none"> (i) Flat A, 62/F, Tower 5 (5B) (ii) Flat A, 62/F, Tower 6 (6A) (iii) Flat A, 62/F, Tower 7 (7A) - There is no window in dining room of other residential properties. - Aluminium window frame fitted with insulated-glass-unit (IGU) with low-emissivity coating for kitchen of the following residential properties: <ul style="list-style-type: none"> (i) Flat A, 62/F, Tower 5 (5B) (ii) Flat A, 62/F, Tower 7 (7A) - Aluminium window frame fitted with clear glass for kitchen in the other residential properties. - Aluminium window frame fitted with tinted obscured glass for open kitchen of the following residential properties: <ul style="list-style-type: none"> (i) Flats E, 7/F to 12/F, 15/F to 16/F, 18/F to 23/F, 25/F to 33/F, 35/F to 39/F, 41/F to 43/F, 45/F to 53/F & 55/F to 62/F, Tower 6 (6A) (ii) Flats C, 7/F to 12/F, 15/F to 16/F, 18/F to 23/F, 25/F to 33/F, 35/F to 39/F, 41/F to 43/F, 45/F to 53/F & 55/F to 62/F, Tower 7 (7A). - Aluminium window frames fitted with obscured glass for bathrooms and toilet (if window is provided) except Flat A, 62/F, Tower 5 (5A) (Bathroom 1), provided with aluminium window frames fitted with insulated-glass-unit (IGU) with low-emissivity coating. <p>(13/F, 14/F, 24/F, 34/F, 44/F & 54/F of Tower 5 (5A & 5B) are omitted.) (13/F, 14/F, 24/F, 34/F, 44/F & 54/F of Tower 6 (6A & 6B) are omitted.) (13/F, 14/F, 24/F, 34/F, 44/F & 54/F of Tower 7 (7A & 7B) are omitted.)</p>
(c) Bay window	Not Applicable.
(d) Planter	Finished with tiles.

1. 外部裝修物料	
細項	描述
(b) 窗	<ul style="list-style-type: none"> - 以下住宅物業的飯廳選用鋁質窗框配雙層中空玻璃配低輻射鍍膜： <ul style="list-style-type: none"> (i) 第5座 (5B)，62樓A單位 (ii) 第6座 (6A)，62樓A單位 (iii) 第7座 (7A)，62樓A單位 - 其他住宅物業的飯廳沒有窗。 - 以下住宅物業的廚房選用鋁質窗框配雙層中空玻璃配低輻射鍍膜： <ul style="list-style-type: none"> (i) 第5座 (5B)，62樓A單位 (ii) 第7座 (7A)，62樓A單位 - 其他住宅物業的廚房選用鋁質窗框配無色玻璃。 - 以下住宅物業的開放式廚房選用鋁質窗框配有磨砂玻璃： <ul style="list-style-type: none"> (i) 第6座 (6A)，7樓至12樓、15樓至16樓、18樓至23樓、25樓至33樓、35樓至39樓、41樓至43樓、45樓至53樓及55樓至62樓E單位 (ii) 第7座 (7A)，7樓至12樓、15樓至16樓、18樓至23樓、25樓至33樓、35樓至39樓、41樓至43樓、45樓至53樓及55樓至62樓C單位 - 浴室及廁所選用鋁質窗框配磨砂玻璃(如有窗)，除第5座 (5A)，62樓A單位 (浴室1)選用鋁質窗框配雙層中空玻璃配低輻射鍍膜。 <p>(第5座 (5A及5B)不設13樓、14樓、24樓、34樓、44樓及54樓。) (第6座 (6A及6B)不設13樓、14樓、24樓、34樓、44樓及54樓。) (第7座 (7A及7B)不設13樓、14樓、24樓、34樓、44樓及54樓。)</p>
(c) 窗台	不適用。
(d) 花槽	鋪砌瓷磚。

Fittings, finishes and appliances

裝置、裝修物料及設備

1. Exterior Finishes	
Item	Description
(e) Verandah or balcony	<ul style="list-style-type: none"> - Balcony provided with aluminium framed glass balustrade and artificial stone top rail. Wall finished with tiles and metal trimming. Floor finished with tiles. - The following residential properties finished with aluminium acoustic ceiling at the balcony: <ul style="list-style-type: none"> (i) Flats C, 9/F to 12/F, 15/F to 16/F, 18/F to 22/F, Tower 5 (5A) (ii) Flats C, 9/F to 12/F, 15/F to 16/F, 18/F to 23/F, 25/F to 33/F & 35/F, Tower 7 (7B) - The following residential properties finished with aluminium ceiling at the balcony: <ul style="list-style-type: none"> (i) Flats C, 8/F, 23/F, 25/F to 33/F, 35/F to 39/F, 41/F to 43/F, 45/F to 53/F & 55/F to 61/F, Tower 5 (5A) (ii) Flats C, 8/F to 12/F, 15/F to 16/F, 18/F to 23/F, 25/F to 33/F, 35/F to 39/F, 41/F to 43/F, 45/F to 53/F & 55/F to 62/F, Tower 6 (6A) (iii) Flats D, 7/F to 12/F, 15/F to 16/F, 18/F to 23/F, 25/F to 33/F, 35/F to 39/F, Tower 6 (6B) (iv) Flats E, 8/F to 12/F, 15/F to 16/F, 18/F to 23/F, 25/F to 33/F, 35/F to 39/F, 41/F to 43/F, 45/F to 53/F & 55/F to 62/F, Tower 6 (6B) (v) Flats D, 8/F to 12/F, 15/F to 16/F, 18/F to 23/F, 25/F to 33/F, 35/F to 39/F, 41/F to 43/F, 45/F to 53/F & 55/F to 62/F, Tower 7 (7A) (vi) Flats E, 7/F to 12/F, 15/F to 16/F, 18/F to 23/F, 25/F to 33/F, 35/F to 39/F, 41/F to 43/F, 45/F to 53/F & 55/F to 62/F, Tower 7 (7A) (vii) Flats C, 8/F, 36/F to 39/F, 41/F to 43/F, 45/F to 53/F & 55/F to 62/F, Tower 7 (7B) - Ceiling finished with external paint for balcony in the other residential properties. - Balconies are covered. - There is no verandah. <p>(13/F, 14/F, 24/F, 34/F, 44/F & 54/F of Tower 5 (5A & 5B) are omitted.) (13/F, 14/F, 24/F, 34/F, 44/F & 54/F of Tower 6 (6A & 6B) are omitted.) (13/F, 14/F, 24/F, 34/F, 44/F & 54/F of Tower 7 (7A & 7B) are omitted.)</p>
(f) Drying facilities for clothing	Not provided.

1. 外部裝修物料	
細項	描述
(e) 陽台或露台	<ul style="list-style-type: none"> - 露台裝設鋁框玻璃圍欄配人造石扶手。牆身鋪砌瓷磚及金屬飾條。地台鋪砌瓷磚。 - 以下住宅物業露台配鋁減音天花： <ul style="list-style-type: none"> (i) 第5座 (5A)，9樓至12樓、15樓至16樓、18樓至22樓C單位 (ii) 第7座 (7B)，9樓至12樓、15樓至16樓、18樓至23樓、25樓至33樓及35樓C單位 - 以下住宅物業露台配鋁天花： <ul style="list-style-type: none"> (i) 第5座 (5A)，8樓、23樓、25樓至33樓、35樓至39樓、41樓至43樓、45樓至53樓及55樓至61樓C單位 (ii) 第6座 (6A)，8樓至12樓、15樓至16樓、18樓至23樓、25樓至33樓、35樓至39樓、41樓至43樓、45樓至53樓及55樓至62樓C單位 (iii) 第6座 (6B)，7樓至12樓、15樓至16樓、18樓至23樓、25樓至33樓、35樓至39樓D單位 (iv) 第6座 (6B)，8樓至12樓、15樓至16樓、18樓至23樓、25樓至33樓、35樓至39樓、41樓至43樓、45樓至53樓及55樓至62樓E單位 (v) 第7座 (7A)，8樓至12樓、15樓至16樓、18樓至23樓、25樓至33樓、35樓至39樓、41樓至43樓、45樓至53樓及55樓至62樓D單位 (vi) 第7座 (7A)，7樓至12樓、15樓至16樓、18樓至23樓、25樓至33樓、35樓至39樓、41樓至43樓、45樓至53樓及55樓至62樓E單位 (vii) 第7座 (7B)，8樓、36樓至39樓、41樓至43樓、45樓至53樓及55樓至62樓C單位 - 其他住宅物業露台天花髹室外油漆。 - 露台有蓋。 - 沒有陽台。 <p>(第5座 (5A及5B)不設13樓、14樓、24樓、34樓、44樓及54樓。) (第6座 (6A及6B)不設13樓、14樓、24樓、34樓、44樓及54樓。) (第7座 (7A及7B)不設13樓、14樓、24樓、34樓、44樓及54樓。)</p>
(f) 乾衣設施	沒有提供。

Fittings, finishes and appliances

裝置、裝修物料及設備

2. Interior Finishes	
Item	Description
(a) Lobby	<p>Lift lobbies on 6/F, Tower 5, Tower 6 and Tower 7</p> <ul style="list-style-type: none"> - Wall finished with paint, metal, plastic laminate and mirror. - Floor finished with natural stone. - False ceiling finished with emulsion paint and aluminium ceiling. <p>Fireman's lift lobbies on 6/F, Tower 5, Tower 6 and Tower 7</p> <p>Service lift lobbies on 7/F to 12/F, 15/F to 16/F, 18/F to 23/F, 25/F to 33/F, 35/F to 39/F, 41/F to 43/F, 45/F to 53/F & 55/F to 62/F, Tower 5,</p> <p>Service lift lobbies on 7/F to 12/F, 15/F to 16/F, 18/F to 23/F, 25/F to 33/F, 35/F to 39/F, 41/F to 43/F, 45/F to 53/F & 55/F to 62/F, Tower 6 and</p> <p>Service lift lobbies on 7/F to 12/F, 15/F to 16/F, 18/F to 23/F, 25/F to 33/F, 35/F to 39/F, 41/F to 43/F, 45/F to 53/F & 55/F to 62/F, Tower 7</p> <ul style="list-style-type: none"> - Wall finished with emulsion paint. - Floor finished with tiles and tile skirting. - False ceiling finished with emulsion paint. <p>Lift lobbies on 7/F to 12/F, 15/F to 16/F, 18/F to 23/F, 25/F to 33/F, 35/F to 39/F, 41/F to 43/F, 45/F to 53/F & 55/F to 62/F, Tower 5</p> <p>Lift lobbies on 7/F to 12/F, 15/F to 16/F, 18/F to 23/F, 25/F to 33/F, 35/F to 39/F, 41/F to 43/F, 45/F to 53/F & 55/F to 62/F, Tower 6 and</p> <p>Lift lobbies on 7/F to 12/F, 15/F to 16/F, 18/F to 23/F, 25/F to 33/F, 35/F to 39/F, 41/F to 43/F, 45/F to 53/F & 55/F to 62/F, Tower 7</p> <ul style="list-style-type: none"> - Wall finished with plastic laminate, metal trimming, paint, mirror and natural stone skirting. - Floor finished with tiles. - Gypsum board false ceiling finished with emulsion paint. <p>(13/F, 14/F, 24/F, 34/F, 44/F & 54/F of Tower 5 (5A & 5B) are omitted.) (13/F, 14/F, 24/F, 34/F, 44/F & 54/F of Tower 6 (6A & 6B) are omitted.) (13/F, 14/F, 24/F, 34/F, 44/F & 54/F of Tower 7 (7A & 7B) are omitted.)</p>

2. 室內裝修物料	
細項	描述
(a) 大堂	<p>第5座、第6座及第7座6樓之升降機大堂</p> <ul style="list-style-type: none"> - 牆身髹油漆、金屬、膠板飾面及鏡。 - 地台鋪砌天然石。 - 假天花髹乳膠漆及鋁質天花。 <p>第5座、第6座及第7座6樓之消防員升降機大堂</p> <p>第5座之7樓至12樓、15樓至16樓、18樓至23樓、25樓至33樓、35樓至39樓、41樓至43樓、45樓至53樓及55樓至62樓之服務升降機大堂</p> <p>第6座之7樓至12樓、15樓至16樓、18樓至23樓、25樓至33樓、35樓至39樓、41樓至43樓、45樓至53樓及55樓至62樓之服務升降機大堂及</p> <p>第7座之7樓至12樓、15樓至16樓、18樓至23樓、25樓至33樓、35樓至39樓、41樓至43樓、45樓至53樓及55樓至62樓之服務升降機大堂</p> <ul style="list-style-type: none"> - 牆身髹油漆。 - 地台鋪砌瓷磚及瓷磚腳線。 - 假天花髹乳膠漆。 <p>第5座之7樓至12樓、15樓至16樓、18樓至23樓、25樓至33樓、35樓至39樓、41樓至43樓、45樓至53樓及55樓至62樓之升降機大堂</p> <p>第6座之7樓至12樓、15樓至16樓、18樓至23樓、25樓至33樓、35樓至39樓、41樓至43樓、45樓至53樓及55樓至62樓之升降機大堂及</p> <p>第7座之7樓至12樓、15樓至16樓、18樓至23樓、25樓至33樓、35樓至39樓、41樓至43樓、45樓至53樓及55樓至62樓之升降機大堂</p> <ul style="list-style-type: none"> - 牆身鋪膠板飾面、金屬條、油漆、鏡及天然石腳線。 - 地台鋪砌瓷磚。 - 石膏板假天花髹乳膠漆。 <p>(第5座 (5A及5B)不設13樓、14樓、24樓、34樓、44樓及54樓。) (第6座 (6A及6B)不設13樓、14樓、24樓、34樓、44樓及54樓。) (第7座 (7A及7B)不設13樓、14樓、24樓、34樓、44樓及54樓。)</p>

Fittings, finishes and appliances

裝置、裝修物料及設備

2. Interior Finishes	
Item	Description
(b) Internal wall and ceiling	<p>- Internal wall of living room and dining room finished with emulsion paint, plastic laminate, metal and mirror finish, except areas above false ceiling level and areas covered by bulkhead at which there are no wall finishes, except internal wall of living room and dining room in the following residential properties finished with emulsion paint, plastic laminate, metal and mirror finish, except areas covered by cabinet, areas above false ceiling level and areas covered by bulkhead at which there are no wall finishes:</p> <p>(i) Flats C, 7/F to 12/F, 15/F to 16/F, 18/F to 23/F, 25/F to 33/F, 35/F to 39/F, 41/F to 43/F, 45/F to 53/F & 55/F to 61/F, Tower 5 (5A)</p> <p>(ii) Flats E, 7/F to 12/F, 15/F to 16/F, 18/F to 23/F, 25/F to 33/F, 35/F to 39/F, 41/F to 43/F, 45/F to 53/F & 55/F to 62/F, Tower 5 (5A)</p> <p>(iii) Flat A, 62/F, Tower 5(5A)</p> <p>(iv) Flat A, 62/F, Tower 5(5B)</p> <p>(v) Flats C, 7/F to 12/F, 15/F to 16/F, 18/F to 23/F, 25/F to 33/F, 35/F to 39/F, 41/F to 43/F, 45/F to 53/F & 55/F to 62/F, Tower 6 (6A)</p> <p>(vi) Flats D, 7/F to 12/F, 15/F to 16/F, 18/F to 23/F, 25/F to 33/F, 35/F to 39/F, 41/F to 43/F, 45/F to 53/F & 55/F to 62/F, Tower 6 (6A)</p> <p>(vii) Flats E, 7/F to 12/F, 15/F to 16/F, 18/F to 23/F, 25/F to 33/F, 35/F to 39/F, 41/F to 43/F, 45/F to 53/F & 55/F to 62/F, Tower 6 (6A)</p> <p>(viii) Flat A, 62/F, Tower 6(6A)</p> <p>(ix) Flats D, 7/F to 12/F, 15/F to 16/F, 18/F to 23/F, 25/F to 33/F, 35/F to 39/F, Tower 6 (6B)</p> <p>(x) Flats E, 7/F to 12/F, 15/F to 16/F, 18/F to 23/F, 25/F to 33/F, 35/F to 39/F, 41/F to 43/F, 45/F to 53/F & 55/F to 62/F, Tower 6 (6B)</p> <p>(xi) Flats F, 7/F to 12/F, 15/F to 16/F, 18/F to 23/F, 25/F to 33/F, 35/F to 39/F, 41/F to 43/F, 45/F to 53/F & 55/F to 62/F, Tower 6 (6B)</p> <p>(xii) Flats C, 7/F to 12/F, 15/F to 16/F, 18/F to 23/F, 25/F to 33/F, 35/F to 39/F, 41/F to 43/F, 45/F to 53/F & 55/F to 62/F, Tower 7 (7A)</p> <p>(xiii) Flats D, 7/F to 12/F, 15/F to 16/F, 18/F to 23/F, 25/F to 33/F, 35/F to 39/F, 41/F to 43/F, 45/F to 53/F & 55/F to 62/F, Tower 7 (7A)</p> <p>(xiv) Flats E, 7/F to 12/F, 15/F to 16/F, 18/F to 23/F, 25/F to 33/F, 35/F to 39/F, 41/F to 43/F, 45/F to 53/F & 55/F to 62/F, Tower 7 (7A)</p> <p>(xv) Flats F, 7/F to 12/F, 15/F to 16/F, 18/F to 23/F, 25/F to 33/F, 35/F to 39/F, 41/F to 43/F, 45/F to 53/F & 55/F to 62/F, Tower 7 (7A)</p> <p>(xvi) Flat A, 62/F, Tower 7(7A)</p> <p>(xvii) Flats C, 7/F to 12/F, 15/F to 16/F, 18/F to 23/F, 25/F to 33/F, 35/F to 39/F, 41/F to 43/F, 45/F to 53/F & 55/F to 62/F, Tower 7 (7B)</p> <p>(xviii) Flat D, 62/F, Tower 7(7B)</p>

2. 室內裝修物料	
細項	描述
(b) 內牆及天花板	<p>- 客廳及飯廳內牆髹乳膠漆、鋪砌膠板飾面、金屬及鏡飾面，但不包括假天花以上及裝飾橫樑遮蓋之牆身，該處之牆身不設裝修物料，除以下住宅物業之客廳及飯廳內牆髹乳膠漆、鋪砌膠板飾面、金屬及鏡飾面，但不包括櫃背牆身、假天花以上及裝飾橫樑遮蓋之牆身，該處之牆身不設裝修物料：</p> <p>(i) 第5座 (5A)，7樓至12樓、15樓至16樓、18樓至23樓、25樓至33樓、35樓至39樓、41樓至43樓、45樓至53樓及55樓至61樓C單位</p> <p>(ii) 第5座 (5A)，7樓至12樓、15樓至16樓、18樓至23樓、25樓至33樓、35樓至39樓、41樓至43樓、45樓至53樓及55樓至62樓E單位</p> <p>(iii) 第5座 (5A)，62樓A單位</p> <p>(iv) 第5座 (5B)，62樓A單位</p> <p>(v) 第6座 (6A)，7樓至12樓、15樓至16樓、18樓至23樓、25樓至33樓、35樓至39樓、41樓至43樓、45樓至53樓及55樓至62樓C單位</p> <p>(vi) 第6座 (6A)，7樓至12樓、15樓至16樓、18樓至23樓、25樓至33樓、35樓至39樓、41樓至43樓、45樓至53樓及55樓至62樓D單位</p> <p>(vii) 第6座 (6A)，7樓至12樓、15樓至16樓、18樓至23樓、25樓至33樓、35樓至39樓、41樓至43樓、45樓至53樓及55樓至62樓E單位</p> <p>(viii) 第6座 (6A)，62樓A單位</p> <p>(ix) 第6座 (6B)，7樓至12樓、15樓至16樓、18樓至23樓、25樓至33樓、35樓至39樓D單位</p> <p>(x) 第6座 (6B)，7樓至12樓、15樓至16樓、18樓至23樓、25樓至33樓、35樓至39樓、41樓至43樓、45樓至53樓及55樓至62樓E單位</p> <p>(xi) 第6座 (6B)，7樓至12樓、15樓至16樓、18樓至23樓、25樓至33樓、35樓至39樓、41樓至43樓、45樓至53樓及55樓至62樓F單位</p> <p>(xii) 第7座 (7A)，7樓至12樓、15樓至16樓、18樓至23樓、25樓至33樓、35樓至39樓、41樓至43樓、45樓至53樓及55樓至62樓C單位</p> <p>(xiii) 第7座 (7A)，7樓至12樓、15樓至16樓、18樓至23樓、25樓至33樓、35樓至39樓、41樓至43樓、45樓至53樓及55樓至62樓D單位</p> <p>(xiv) 第7座 (7A)，7樓至12樓、15樓至16樓、18樓至23樓、25樓至33樓、35樓至39樓、41樓至43樓、45樓至53樓及55樓至62樓E單位</p> <p>(xv) 第7座 (7A)，7樓至12樓、15樓至16樓、18樓至23樓、25樓至33樓、35樓至39樓、41樓至43樓、45樓至53樓及55樓至62樓F單位</p> <p>(xvi) 第7座 (7A)，62樓A單位</p> <p>(xvii) 第7座 (7B)，7樓至12樓、15樓至16樓、18樓至23樓、25樓至33樓、35樓至39樓、41樓至43樓、45樓至53樓及55樓至62樓C單位</p> <p>(xviii) 第7座 (7B)，62樓D單位</p>

Fittings, finishes and appliances

裝置、裝修物料及設備

2. Interior Finishes	
Item	Description
(b) Internal wall and ceiling	<ul style="list-style-type: none"> - Internal wall of master bedroom and bedroom finished with emulsion paint, except area above false ceiling level and area covered by bulkhead at which there are no wall finishes, except Internal wall of bedroom in the following residential property finished with emulsion paint and plastic laminate, except area above false ceiling level and area covered by bulkhead at which there are no wall finishes: <ul style="list-style-type: none"> (i) Flat A, 62/F, Tower 5(5A) (Bedroom 3) - Ceiling of living room and dining room finished with emulsion paint where exposed; other parts provided with gypsum board false ceiling and bulkhead, finished with emulsion paint, except ceiling of living room and dining room in the following residential properties finished with emulsion paint where exposed; other parts provided with bulkhead, finished with emulsion paint: <ul style="list-style-type: none"> (i) Flats E, 7/F to 12/F, 15/F to 16/F, 18/F to 23/F, 25/F to 33/F, 35/F to 39/F, 41/F to 43/F, 45/F to 53/F & 55/F to 62/F, Tower 7 (7B) - Ceiling of master bedroom finished with emulsion paint where exposed; other parts provided with bulkhead, finished with emulsion paint, except master bedroom in the following residential properties other parts provided with gypsum board false ceiling and bulkhead, finished with emulsion paint: <ul style="list-style-type: none"> (i) Flats A, 7/F to 12/F, 15/F to 16/F, 18/F to 23/F, 25/F to 33/F, 35/F to 39/F, 41/F to 43/F, 45/F to 53/F & 55/F to 61/F, Tower 5 (5A) (ii) Flats A, 7/F to 12/F, 15/F to 16/F, 18/F to 23/F, 25/F to 33/F, 35/F to 39/F, 41/F to 43/F, 45/F to 53/F & 55/F to 61/F, Tower 5 (5B) (iii) Flat A, 62/F, Tower 5 (5B) (iv) Flats B, 7/F to 12/F, 15/F to 16/F, 18/F to 23/F, 25/F to 33/F, 35/F to 39/F, 41/F to 43/F, 45/F to 53/F & 55/F to 61/F, Tower 5 (5B) (v) Flats A, 7/F to 12/F, 15/F to 16/F, 18/F to 23/F, 25/F to 33/F, 35/F to 39/F, 41/F to 43/F, 45/F to 53/F & 55/F to 61/F, Tower 6 (6A) (vi) Flats E, 7/F to 12/F, 15/F to 16/F, 18/F to 23/F, 25/F to 33/F, 35/F to 39/F, 41/F to 43/F, 45/F to 53/F & 55/F to 62/F, Tower 6 (6A) (vii) Flat A, 62/F, Tower 6 (6A) (viii) Flats A, 7/F to 12/F, 15/F to 16/F, 18/F to 23/F, 25/F to 33/F, 35/F to 39/F, 41/F to 43/F, 45/F to 53/F & 55/F to 62/F, Tower 6 (6B) (ix) Flats C, 41/F to 43/F, 45/F to 53/F & 55/F to 62/F, Tower 6 (6B) (x) Flats A, 7/F to 12/F, 15/F to 16/F, 18/F to 23/F, 25/F to 33/F, 35/F to 39/F, 41/F to 43/F, 45/F to 53/F & 55/F to 61/F, Tower 7 (7A) (xi) Flats B, 7/F to 12/F, 15/F to 16/F, 18/F to 23/F, 25/F to 33/F, 35/F to 39/F, 41/F to 43/F, 45/F to 53/F & 55/F to 61/F, Tower 7 (7A) (xii) Flat A, 62/F, Tower 7 (7A) (xiii) Flats A, 7/F to 12/F, 15/F to 16/F, 18/F to 23/F, 25/F to 33/F, 35/F to 39/F, 41/F to 43/F, 45/F to 53/F & 55/F to 62/F, Tower 7 (7B) (xiv) Flats B, 7/F to 12/F, 15/F to 16/F, 18/F to 23/F, 25/F to 33/F, 35/F to 39/F, 41/F to 43/F, 45/F to 53/F & 55/F to 62/F, Tower 7 (7B) (xv) Flats D, 7/F to 12/F, 15/F to 16/F, 18/F to 23/F, 25/F to 33/F, 35/F to 39/F, 41/F to 43/F, 45/F to 53/F & 55/F to 61/F, Tower 7 (7B) (xvi) Flat D, 62/F, Tower 7 (7B)

2. 室內裝修物料	
細項	描述
(b) 內牆及天花板	<ul style="list-style-type: none"> - 主人睡房及睡房內牆髹乳膠漆，但不包括假天花以上及被裝飾橫樑遮蓋之牆身，該處之牆身不設裝修物料，除以下住宅物業之睡房內牆髹乳膠漆及鋪砌膠板飾面，但不包括假天花以上及裝飾橫樑遮蓋之牆身，該處之牆身不設裝修物料： <ul style="list-style-type: none"> (i) 第5座(5A)，62樓A單位(睡房3) - 客廳及飯廳外露的天花髹乳膠漆，其他部分設有石膏板假天花及裝飾橫樑髹乳膠漆，除以下住宅物業之客廳及飯廳外露的天花髹乳膠漆，其他部分設有裝飾橫樑髹乳膠漆： <ul style="list-style-type: none"> (i) 第7座(7B)，7樓至12樓、15樓至16樓、18樓至23樓、25樓至33樓、35樓至39樓、41樓至43樓、45樓至53樓及55樓至62樓E單位 - 主人睡房外露的天花髹乳膠漆，其他部分設有裝飾橫樑髹乳膠漆，除以下住宅物業之主人睡房其他部分設有石膏板假天花及裝飾橫樑髹乳膠漆： <ul style="list-style-type: none"> (i) 第5座(5A)，7樓至12樓、15樓至16樓、18樓至23樓、25樓至33樓、35樓至39樓、41樓至43樓、45樓至53樓及55樓至61樓A單位 (ii) 第5座(5B)，7樓至12樓、15樓至16樓、18樓至23樓、25樓至33樓、35樓至39樓、41樓至43樓、45樓至53樓及55樓至61樓A單位 (iii) 第5座(5B)，62樓A單位 (iv) 第5座(5B)，7樓至12樓、15樓至16樓、18樓至23樓、25樓至33樓、35樓至39樓、41樓至43樓、45樓至53樓及55樓至61樓B單位 (v) 第6座(6A)，7樓至12樓、15樓至16樓、18樓至23樓、25樓至33樓、35樓至39樓、41樓至43樓、45樓至53樓及55樓至61樓A單位 (vi) 第6座(6A)，7樓至12樓、15樓至16樓、18樓至23樓、25樓至33樓、35樓至39樓、41樓至43樓、45樓至53樓及55樓至62樓E單位 (vii) 第6座(6A)，62樓A單位 (viii) 第6座(6B)，7樓至12樓、15樓至16樓、18樓至23樓、25樓至33樓、35樓至39樓、41樓至43樓、45樓至53樓及55樓至62樓A單位 (ix) 第6座(6B)，41樓至43樓、45樓至53樓及55樓至62樓C單位 (x) 第7座(7A)，7樓至12樓、15樓至16樓、18樓至23樓、25樓至33樓、35樓至39樓、41樓至43樓、45樓至53樓及55樓至61樓A單位 (xi) 第7座(7A)，7樓至12樓、15樓至16樓、18樓至23樓、25樓至33樓、35樓至39樓、41樓至43樓、45樓至53樓及55樓至61樓B單位 (xii) 第7座(7A)，62樓A單位 (xiii) 第7座(7B)，7樓至12樓、15樓至16樓、18樓至23樓、25樓至33樓、35樓至39樓、41樓至43樓、45樓至53樓及55樓至62樓A單位 (xiv) 第7座(7B)，7樓至12樓、15樓至16樓、18樓至23樓、25樓至33樓、35樓至39樓、41樓至43樓、45樓至53樓及55樓至62樓B單位 (xv) 第7座(7B)，7樓至12樓、15樓至16樓、18樓至23樓、25樓至33樓、35樓至39樓、41樓至43樓、45樓至53樓及55樓至61樓D單位 (xvi) 第7座(7B)，62樓D單位

Fittings, finishes and appliances

裝置、裝修物料及設備

2. Interior Finishes	
Item	Description
(b) Internal wall and ceiling	<ul style="list-style-type: none"> - Ceiling of bedroom finished with emulsion paint where exposed; other parts provided with bulkhead, finished with emulsion paint, except bedroom in the following residential properties other parts provided with gypsum board false ceiling and bulkhead, finished with emulsion paint: <ul style="list-style-type: none"> (i) Flat A, 62/F, Tower 5 (5A) (Bedroom 3) (ii) Flat A, 62/F, Tower 5 (5B) (Bedroom 1) (iii) Flat A, 62/F, Tower 6 (6A) (Bedroom 1) (iv) Flat A, 62/F, Tower 7 (7A) (Bedroom 1) <p>(13/F, 14/F, 24/F, 34/F, 44/F & 54/F of Tower 5 (5A & 5B) are omitted.) (13/F, 14/F, 24/F, 34/F, 44/F & 54/F of Tower 6 (6A & 6B) are omitted.) (13/F, 14/F, 24/F, 34/F, 44/F & 54/F of Tower 7 (7A & 7B) are omitted.)</p>
(c) Internal floor	<ul style="list-style-type: none"> - Internal floor of living room and dining room finished with engineered timber floor, tiles, metal trimming and timber skirting. - Internal floor of master bedroom finished with engineered timber floor, tiles, metal trimming and timber skirting, except master bedroom in the following residential properties finished with engineered timber floor and timber skirting: <ul style="list-style-type: none"> (i) Flat D, 7/F, Tower 5 (5A) (ii) Flat A, 62/F, Tower 5 (5A) (iii) Flat D, 7/F, Tower 5 (5B) (iv) Flat C, 7/F, Tower 6 (6A) (v) Flat D, 7/F, Tower 6 (6A) (vi) Flat A, 62/F, Tower 6 (6A) (vii) Flats E, 7/F to 12/F, 15/F to 16/F, 18/F to 23/F, 25/F to 33/F, 35/F to 39/F, 41/F to 43/F, 45/F to 53/F & 55/F to 62/F, Tower 6 (6B) (viii) Flats D, 7/F to 12/F, 15/F to 16/F, 18/F to 23/F, 25/F to 33/F, 35/F to 39/F, 41/F to 43/F, 45/F to 53/F & 55/F to 62/F, Tower 7 (7A) (ix) Flats F, 7/F to 12/F, 15/F to 16/F, 18/F to 23/F, 25/F to 33/F, 35/F to 39/F, 41/F to 43/F, 45/F to 53/F & 55/F to 62/F, Tower 7 (7A) (x) Flat A, 62/F, Tower 7 (7A) (xi) Flat A, 7/F, Tower 7 (7B) (xii) Flats C, 7/F to 12/F, 15/F to 16/F, 18/F to 23/F, 25/F to 33/F, 35/F to 39/F, 41/F to 43/F, 45/F to 53/F & 55/F to 62/F, Tower 7 (7B) - Internal floor of bedroom finished with engineered timber floor and timber skirting, except bedroom in the following residential properties finished with engineered timber floor, tiles, metal trimming and timber skirting: <ul style="list-style-type: none"> (i) Flat A, 62/F, Tower 5 (5A) (Bedroom 3) <p>(13/F, 14/F, 24/F, 34/F, 44/F & 54/F of Tower 5 (5A & 5B) are omitted.) (13/F, 14/F, 24/F, 34/F, 44/F & 54/F of Tower 6 (6A & 6B) are omitted.) (13/F, 14/F, 24/F, 34/F, 44/F & 54/F of Tower 7 (7A & 7B) are omitted.)</p>

2. 室內裝修物料	
細項	描述
(b) 內牆及天花板	<ul style="list-style-type: none"> - 睡房外露的天花髹乳膠漆，其他部分設有裝飾橫樑髹乳膠漆，除以下住宅物業之睡房其他部分設有石膏板假天花及裝飾橫樑髹乳膠漆： <ul style="list-style-type: none"> (i) 第5座(5A)，62樓A單位(睡房3) (ii) 第5座(5B)，62樓A單位(睡房1) (iii) 第6座(6A)，62樓A單位(睡房1) (iv) 第7座(7A)，62樓A單位(睡房1) <p>(第5座 (5A及5B)不設13樓、14樓、24樓、34樓、44樓及54樓。) (第6座 (6A及6B)不設13樓、14樓、24樓、34樓、44樓及54樓。) (第7座 (7A及7B)不設13樓、14樓、24樓、34樓、44樓及54樓。)</p>
(c) 內部地板	<ul style="list-style-type: none"> - 客廳及飯廳內部地板鋪砌複合木地板、瓷磚、金屬條及木腳線。 - 主人睡房內部地板鋪砌複合木地板、瓷磚、金屬條及木腳線，除以下住宅物業之主人睡房鋪砌複合木地板及木腳線： <ul style="list-style-type: none"> (i) 第5座(5A)，7樓D單位 (ii) 第5座 (5A)，62樓A單位 (iii) 第5座(5B)，7樓D單位 (iv) 第6座(6A)，7樓C單位 (v) 第6座(6A)，7樓D單位 (vi) 第6座 (6A)，62樓A單位 (vii) 第6座(6B)，7樓至12樓、15樓至16樓、18樓至23樓、25樓至33樓、35樓至39樓、41樓至43樓、45樓至53樓及55樓至62樓E單位 (viii) 第7座(7A)，7樓至12樓、15樓至16樓、18樓至23樓、25樓至33樓、35樓至39樓、41樓至43樓、45樓至53樓及55樓至62樓D單位 (ix) 第7座(7A)，7樓至12樓、15樓至16樓、18樓至23樓、25樓至33樓、35樓至39樓、41樓至43樓、45樓至53樓及55樓至62樓F單位 (x) 第7座 (7A)，62樓A單位 (xi) 第7座(7B)，7樓A單位 (xii) 第7座(7B)，7樓至12樓、15樓至16樓、18樓至23樓、25樓至33樓、35樓至39樓、41樓至43樓、45樓至53樓及55樓至62樓C單位 - 睡房內部地板鋪砌複合木地板及木腳線，除以下住宅物業之睡房鋪砌複合木地板，瓷磚、金屬條及木腳線： <ul style="list-style-type: none"> (i) 第5座 (5A)，62樓A單位 (睡房3) <p>(第5座 (5A及5B)不設13樓、14樓、24樓、34樓、44樓及54樓。) (第6座 (6A及6B)不設13樓、14樓、24樓、34樓、44樓及54樓。) (第7座 (7A及7B)不設13樓、14樓、24樓、34樓、44樓及54樓。)</p>

Fittings, finishes and appliances

裝置、裝修物料及設備

2. Interior Finishes	
Item	Description
(d) Bathroom	<ul style="list-style-type: none"> - Wall finished with tiles (except areas covered by aluminium cladding, vanity counter, mirror cabinets, cabinet and areas above false ceiling level and areas covered by bulkhead at which there are no wall finishes). - Floor finished with tiles and metal trimming, except the following residential properties floor finished with tiles: <ul style="list-style-type: none"> (i) Flats A, 7/F to 12/F, 15/F to 16/F, 18/F to 23/F, 25/F to 33/F, 35/F to 39/F, 41/F to 43/F, 45/F to 53/F & 55/F to 61/F, Tower 5 (5A)(Bathroom 1) (ii) Flat A, 62/F, Tower 5 (5A)(Bathroom 1 and Bathroom 2) (iii) Flats B, 7/F to 12/F, 15/F to 16/F, 18/F to 23/F, 25/F to 33/F, 35/F to 39/F, 41/F to 43/F, 45/F to 53/F & 55/F to 62/F, Tower 5 (5A)(Bathroom 1) (iv) Flats A, 7/F to 12/F, 15/F to 16/F, 18/F to 23/F, 25/F to 33/F, 35/F to 39/F, 41/F to 43/F, 45/F to 53/F & 55/F to 61/F, Tower 5 (5B)(Bathroom 1) (v) Flat A, 62/F, Tower 5 (5B)(Bathroom 1, Bathroom 2 and Bathroom 3) (vi) Flats B, 7/F to 12/F, 15/F to 16/F, 18/F to 23/F, 25/F to 33/F, 35/F to 39/F, 41/F to 43/F, 45/F to 53/F & 55/F to 61/F, Tower 5 (5B)(Bathroom 1) (vii) Flats A, 7/F to 12/F, 15/F to 16/F, 18/F to 23/F, 25/F to 33/F, 35/F to 39/F, 41/F to 43/F, 45/F to 53/F & 55/F to 61/F, Tower 6 (6A)(Bathroom 1) (viii) Flat A, 62/F, Tower 6 (6A)(Bathroom 1, Bathroom 2 and Bathroom 3) (ix) Flats B, 7/F to 12/F, 15/F to 16/F, 18/F to 23/F, 25/F to 33/F, 35/F to 39/F, 41/F to 43/F, 45/F to 53/F & 55/F to 61/F, Tower 6 (6A)(Bathroom 1) (x) Flats A, 7/F to 12/F, 15/F to 16/F, 18/F to 23/F, 25/F to 33/F, 35/F to 39/F, 41/F to 43/F, 45/F to 53/F & 55/F to 62/F, Tower 6 (6B)(Bathroom 1) (xi) Flats C, 41/F to 43/F, 45/F to 53/F & 55/F to 62/F, Tower 6 (6B)(Bathroom 1) (xii) Flats A, 7/F to 12/F, 15/F to 16/F, 18/F to 23/F, 25/F to 33/F, 35/F to 39/F, 41/F to 43/F, 45/F to 53/F & 55/F to 61/F, Tower 7 (7A)(Bathroom 1) (xiii) Flat A, 62/F, Tower 7 (7A)(Bathroom 1, Bathroom 2 and Bathroom 3) (xiv) Flats B, 7/F to 12/F, 15/F to 16/F, 18/F to 23/F, 25/F to 33/F, 35/F to 39/F, 41/F to 43/F, 45/F to 53/F & 55/F to 61/F, Tower 7 (7A)(Bathroom 1) (xv) Flats A, 7/F to 12/F, 15/F to 16/F, 18/F to 23/F, 25/F to 33/F, 35/F to 39/F, 41/F to 43/F, 45/F to 53/F & 55/F to 62/F, Tower 7 (7B)(Bathroom 1) (xvi) Flats B, 7/F to 12/F, 15/F to 16/F, 18/F to 23/F, 25/F to 33/F, 35/F to 39/F, 41/F to 43/F, 45/F to 53/F & 55/F to 62/F, Tower 7 (7B)(Bathroom 1) (xvii) Flats D, 7/F to 12/F, 15/F to 16/F, 18/F to 23/F, 25/F to 33/F, 35/F to 39/F, 41/F to 43/F, 45/F to 53/F & 55/F to 61/F, Tower 7 (7B)(Bathroom 1) (xviii) Flat D, 62/F, Tower 7 (7B)(Bathroom 1 and Bathroom 2)

2. 室內裝修物料	
細項	描述
(d) 浴室	<ul style="list-style-type: none"> - 牆身鋪砌瓷磚 (但不包括鋁覆蓋板、檯面櫃、鏡櫃、櫃、假天花以上及裝飾橫樑遮蓋之位置，該處之牆身不設裝修物料)。 - 地台鋪砌瓷磚及金屬條，除以下住宅物業地台鋪砌瓷磚： <ul style="list-style-type: none"> (i) 第5座(5A)，7樓至12樓、15樓至16樓、18樓至23樓、25樓至33樓、35樓至39樓、41樓至43樓、45樓至53樓及55樓至61樓A單位(浴室1) (ii) 第5座(5A)，62樓A單位(浴室1及浴室2) (iii) 第5座(5A)，7樓至12樓、15樓至16樓、18樓至23樓、25樓至33樓、35樓至39樓、41樓至43樓、45樓至53樓及55樓至62樓B單位(浴室1) (iv) 第5座(5B)，7樓至12樓、15樓至16樓、18樓至23樓、25樓至33樓、35樓至39樓、41樓至43樓、45樓至53樓及55樓至61樓A單位(浴室1) (v) 第5座(5B)，62樓A單位(浴室1, 浴室2及浴室3) (vi) 第5座(5B)，7樓至12樓、15樓至16樓、18樓至23樓、25樓至33樓、35樓至39樓、41樓至43樓、45樓至53樓及55樓至61樓B單位(浴室1) (vii) 第6座(6A)，7樓至12樓、15樓至16樓、18樓至23樓、25樓至33樓、35樓至39樓、41樓至43樓、45樓至53樓及55樓至61樓A單位(浴室1) (viii) 第6座(6A)，62樓A單位(浴室1, 浴室2及浴室3) (ix) 第6座(6A)，7樓至12樓、15樓至16樓、18樓至23樓、25樓至33樓、35樓至39樓、41樓至43樓、45樓至53樓及55樓至61樓B單位(浴室1) (x) 第6座(6B)，7樓至12樓、15樓至16樓、18樓至23樓、25樓至33樓、35樓至39樓、41樓至43樓、45樓至53樓及55樓至62樓A單位(浴室1) (xi) 第6座(6B)，41樓至43樓、45樓至53樓及55樓至62樓C單位(浴室1) (xii) 第7座(7A)，7樓至12樓、15樓至16樓、18樓至23樓、25樓至33樓、35樓至39樓、41樓至43樓、45樓至53樓及55樓至61樓A單位(浴室1) (xiii) 第7座(7A)，62樓A單位(浴室1, 浴室2及浴室3) (xiv) 第7座(7A)，7樓至12樓、15樓至16樓、18樓至23樓、25樓至33樓、35樓至39樓、41樓至43樓、45樓至53樓及55樓至61樓B單位(浴室1) (xv) 第7座(7B)，7樓至12樓、15樓至16樓、18樓至23樓、25樓至33樓、35樓至39樓、41樓至43樓、45樓至53樓及55樓至62樓A單位(浴室1) (xvi) 第7座(7B)，7樓至12樓、15樓至16樓、18樓至23樓、25樓至33樓、35樓至39樓、41樓至43樓、45樓至53樓及55樓至62樓B單位(浴室1) (xvii) 第7座(7B)，7樓至12樓、15樓至16樓、18樓至23樓、25樓至33樓、35樓至39樓、41樓至43樓、45樓至53樓及55樓至61樓D單位(浴室1) (xviii) 第7座(7B)，62樓D單位(浴室1及浴室2)

Fittings, finishes and appliances

裝置、裝修物料及設備

2. Interior Finishes	
Item	Description
(d) Bathroom	<ul style="list-style-type: none"> - Floor of shower cubicle finished with tiles and metal trimming. - Ceiling provided with gypsum board false ceiling finished with emulsion paint. - Wall finishes run up to the level of false ceiling. <p>(13/F, 14/F, 24/F, 34/F, 44/F & 54/F of Tower 5 (5A & 5B) are omitted.) (13/F, 14/F, 24/F, 34/F, 44/F & 54/F of Tower 6 (6A & 6B) are omitted.) (13/F, 14/F, 24/F, 34/F, 44/F & 54/F of Tower 7 (7A & 7B) are omitted.)</p>
(e) Kitchen	<p>Open kitchen</p> <ul style="list-style-type: none"> - Wall finished with plastic laminate and colour backing glass (except areas covered by kitchen cabinet, areas above false ceiling level and areas covered by bulkhead at which there are no wall finishes). - Floor finished with tiles, engineered timber floor and metal trimming (except areas covered by kitchen cabinet). - Gypsum board false ceiling and bulkhead finished with emulsion paint. - Cooking bench top is finished with acrylic solid surface. - Wall finishes run up to the level of false ceiling. <p>Kitchen</p> <ul style="list-style-type: none"> - Wall finished with tiles and colour backing glass (except areas covered by kitchen cabinet, areas above false ceiling level and areas covered by bulkhead at which there are no wall finishes). - Floor finished with tiles (except areas covered by kitchen cabinet). - Gypsum board false ceiling finished with emulsion paint. - Cooking bench top finished with acrylic solid surface. - Wall finishes run up to the level of false ceiling.

2. 室內裝修物料	
細項	描述
(d) 浴室	<ul style="list-style-type: none"> - 淋浴間之地台鋪砌瓷磚及金屬條。 - 鋪砌石膏板假天花髹乳膠漆。 - 牆身飾面鋪砌至假天花底。 <p>(第5座 (5A及5B)不設13樓、14樓、24樓、34樓、44樓及54樓。) (第6座 (6A及6B)不設13樓、14樓、24樓、34樓、44樓及54樓。) (第7座 (7A及7B)不設13樓、14樓、24樓、34樓、44樓及54樓。)</p>
(e) 廚房	<p>開放式廚房</p> <ul style="list-style-type: none"> - 牆身鋪砌膠板飾面及背漆玻璃 (但不包括廚櫃背牆身、假天花以上及裝飾橫樑遮蓋的位置，該處之牆身不設裝修物料)。 - 地台鋪砌瓷磚、複合木地板及金屬條 (但不包括廚櫃遮蓋的位置)。 - 石膏板假天花及裝飾橫樑髹乳膠漆。 - 灶台面的裝修物料為人造石。 - 牆身飾面鋪砌至假天花底。 <p>廚房</p> <ul style="list-style-type: none"> - 牆身鋪砌瓷磚、背漆玻璃 (但不包括廚櫃背牆身、假天花以上及裝飾橫樑遮蓋的位置，該處之牆身不設裝修物料)。 - 地台鋪砌瓷磚 (但不包括廚櫃遮蓋的位置)。 - 鋪砌石膏板假天花髹乳膠漆。 - 灶台面的裝修物料為人造石。 - 牆身飾面鋪砌至假天花底。

Fittings, finishes and appliances

裝置、裝修物料及設備

3. Interior Fittings	
Item	Description
(a) Doors	<p>Main entrance of residential property</p> <ul style="list-style-type: none"> - Solid core fire rated timber door finished with plastic laminate, metal, fitted with lockset, door closer, eye viewer, security door chain and door stopper. <p>Master bedroom and bedroom</p> <ul style="list-style-type: none"> - Hollow core timber door finished with plastic laminate, fitted with lockset and door stopper. <p>Kitchen</p> <ul style="list-style-type: none"> - Solid core fire rated timber door finished with plastic laminate, metal and fire rated glass panel, fitted with door closer, handle and door stopper, except kitchen in the following residential properties provided with solid fire rated timber door, finished with plastic laminate, metal and fire rated glass panel, fitted with door closer and handle: <ul style="list-style-type: none"> (i) Flats A, 7/F to 12/F, 15/F to 16/F, 18/F to 23/F, 25/F to 33/F, 35/F to 39/F, 41/F to 43/F, 45/F to 53/F & 55/F to 61/F, Tower 5 (5A) (ii) Flats B, 7/F to 12/F, 15/F to 16/F, 18/F to 23/F, 25/F to 33/F, 35/F to 39/F, 41/F to 43/F, 45/F to 53/F & 55/F to 62/F, Tower 5 (5A) (iii) Flats A, 7/F to 12/F, 15/F to 16/F, 18/F to 23/F, 25/F to 33/F, 35/F to 39/F, 41/F to 43/F, 45/F to 53/F & 55/F to 61/F, Tower 5 (5B) (iv) Flats B, 7/F to 12/F, 15/F to 16/F, 18/F to 23/F, 25/F to 33/F, 35/F to 39/F, 41/F to 43/F, 45/F to 53/F & 55/F to 61/F, Tower 5 (5B) (v) Flats A, 7/F to 12/F, 15/F to 16/F, 18/F to 23/F, 25/F to 33/F, 35/F to 39/F, 41/F to 43/F, 45/F to 53/F & 55/F to 61/F, Tower 6 (6A) (vi) Flats B, 7/F to 12/F, 15/F to 16/F, 18/F to 23/F, 25/F to 33/F, 35/F to 39/F, 41/F to 43/F, 45/F to 53/F & 55/F to 61/F, Tower 6 (6A) (vii) Flats A, 7/F to 12/F, 15/F to 16/F, 18/F to 23/F, 25/F to 33/F, 35/F to 39/F, 41/F to 43/F, 45/F to 53/F & 55/F to 61/F, Tower 7 (7A) (viii) Flats B, 7/F to 12/F, 15/F to 16/F, 18/F to 23/F, 25/F to 33/F, 35/F to 39/F, 41/F to 43/F, 45/F to 53/F & 55/F to 61/F, Tower 7 (7A) (ix) Flats A, 7/F to 12/F, 15/F to 16/F, 18/F to 23/F, 25/F to 33/F, 35/F to 39/F, 41/F to 43/F, 45/F to 53/F & 55/F to 62/F, Tower 7 (7B) (x) Flats B, 7/F to 12/F, 15/F to 16/F, 18/F to 23/F, 25/F to 33/F, 35/F to 39/F, 41/F to 43/F, 45/F to 53/F & 55/F to 62/F, Tower 7 (7B) <p>(13/F, 14/F, 24/F, 34/F, 44/F & 54/F of Tower 5 (5A & 5B) are omitted.) (13/F, 14/F, 24/F, 34/F, 44/F & 54/F of Tower 6 (6A & 6B) are omitted.) (13/F, 14/F, 24/F, 34/F, 44/F & 54/F of Tower 7 (7A & 7B) are omitted.)</p> <p>Utility room</p> <ul style="list-style-type: none"> - Hollow core timber door finished with plastic laminate, fitted with lockset and door stopper. <p>(13/F, 14/F, 24/F, 34/F, 44/F & 54/F of Tower 5 (5A & 5B) are omitted.) (13/F, 14/F, 24/F, 34/F, 44/F & 54/F of Tower 6 (6A & 6B) are omitted.) (13/F, 14/F, 24/F, 34/F, 44/F & 54/F of Tower 7 (7A & 7B) are omitted.)</p>

3. 室內裝置	
細項	描述
(a) 門	<p>住宅物業大門</p> <ul style="list-style-type: none"> - 實心防火木門配膠板飾面、金屬飾面，裝設門鎖、氣鼓、防盜眼、防盜鏈及門擋。 <p>主人睡房及睡房</p> <ul style="list-style-type: none"> - 空心木門配膠板飾面，裝設門鎖及門擋。 <p>廚房</p> <ul style="list-style-type: none"> - 實心防火木門配膠板飾面、金屬飾面及防火玻璃，裝設氣鼓、門抽及門擋。除以下住宅物業之廚房選用實心防火木門配膠板飾面、金屬飾面及防火玻璃，裝設氣鼓及門抽： <ul style="list-style-type: none"> (i) 第5座 (5A)，7樓至12樓、15樓至16樓、18樓至23樓、25樓至33樓、35樓至39樓、41樓至43樓、45樓至53樓及55樓至61樓A單位 (ii) 第5座 (5A)，7樓至12樓、15樓至16樓、18樓至23樓、25樓至33樓、35樓至39樓、41樓至43樓、45樓至53樓及55樓至62樓B單位 (iii) 第5座 (5B)，7樓至12樓、15樓至16樓、18樓至23樓、25樓至33樓、35樓至39樓、41樓至43樓、45樓至53樓及55樓至61樓A單位 (iv) 第5座 (5B)，7樓至12樓、15樓至16樓、18樓至23樓、25樓至33樓、35樓至39樓、41樓至43樓、45樓至53樓及55樓至61樓B單位 (v) 第6座 (6A)，7樓至12樓、15樓至16樓、18樓至23樓、25樓至33樓、35樓至39樓、41樓至43樓、45樓至53樓及55樓至61樓A單位 (vi) 第6座 (6A)，7樓至12樓、15樓至16樓、18樓至23樓、25樓至33樓、35樓至39樓、41樓至43樓、45樓至53樓及55樓至61樓B單位 (vii) 第7座 (7A)，7樓至12樓、15樓至16樓、18樓至23樓、25樓至33樓、35樓至39樓、41樓至43樓、45樓至53樓及55樓至61樓A單位 (viii) 第7座 (7A)，7樓至12樓、15樓至16樓、18樓至23樓、25樓至33樓、35樓至39樓、41樓至43樓、45樓至53樓及55樓至61樓B單位 (ix) 第7座 (7B)，7樓至12樓、15樓至16樓、18樓至23樓、25樓至33樓、35樓至39樓、41樓至43樓、45樓至53樓及55樓至62樓A單位 (x) 第7座 (7B)，7樓至12樓、15樓至16樓、18樓至23樓、25樓至33樓、35樓至39樓、41樓至43樓、45樓至53樓及55樓至62樓B單位 <p>(第5座 (5A及5B)不設13樓、14樓、24樓、34樓、44樓及54樓。) (第6座 (6A及6B)不設13樓、14樓、24樓、34樓、44樓及54樓。) (第7座 (7A及7B)不設13樓、14樓、24樓、34樓、44樓及54樓。)</p> <p>工作間</p> <ul style="list-style-type: none"> - 空心木門配膠板飾面，裝設門鎖及門擋。 <p>(第5座 (5A及5B)不設13樓、14樓、24樓、34樓、44樓及54樓。) (第6座 (6A及6B)不設13樓、14樓、24樓、34樓、44樓及54樓。) (第7座 (7A及7B)不設13樓、14樓、24樓、34樓、44樓及54樓。)</p>

Fittings, finishes and appliances

裝置、裝修物料及設備

3. Interior Fittings	
Item	Description
(a) Doors	<p>Bathroom</p> <ul style="list-style-type: none"> - Hollow core timber door finished with plastic laminate, fitted with timber louvre, lockset and door stopper for bathrooms in the following residential properties: (i) Flats B, 7/F to 12/F, 15/F to 16/F, 18/F to 23/F, 25/F to 33/F, 35/F to 39/F, 41/F to 43/F, 45/F to 53/F & 55/F to 62/F, Tower 5 (5A) (Bathroom 1) (ii) Flats E, 7/F to 12/F, 15/F to 16/F, 18/F to 23/F, 25/F to 33/F, 35/F to 39/F, 41/F to 43/F, 45/F to 53/F & 55/F to 62/F, Tower 5 (5A) (Bathroom) (iii) Flat A, 62/F, Tower 5 (5A) (Bathroom 2) (iv) Flats A, 7/F to 12/F, 15/F to 16/F, 18/F to 23/F, 25/F to 33/F, 35/F to 39/F, 41/F to 43/F, 45/F to 53/F & 55/F to 61/F, Tower 5 (5B) (Bathroom 1) (v) Flat A, 62/F, Tower 5 (5B) (Bathroom 1 and Bathroom 2) (vi) Flats A, 7/F to 12/F, 15/F to 16/F, 18/F to 23/F, 25/F to 33/F, 35/F to 39/F, 41/F to 43/F, 45/F to 53/F & 55/F to 61/F, Tower 6 (6A) (Bathroom 1) (vii) Flats B, 7/F to 12/F, 15/F to 16/F, 18/F to 23/F, 25/F to 33/F, 35/F to 39/F, 41/F to 43/F, 45/F to 53/F & 55/F to 61/F, Tower 6 (6A) (Bathroom 1) (viii) Flats C, 41/F to 43/F, 45/F to 53/F & 55/F to 62/F, Tower 6 (6B) (Bathroom 1) (ix) Flats A, 7/F to 12/F, 15/F to 16/F, 18/F to 23/F, 25/F to 33/F, 35/F to 39/F, 41/F to 43/F, 45/F to 53/F & 55/F to 61/F, Tower 7 (7A) (Bathroom 1) (x) Flats B, 7/F to 12/F, 15/F to 16/F, 18/F to 23/F, 25/F to 33/F, 35/F to 39/F, 41/F to 43/F, 45/F to 53/F & 55/F to 61/F, Tower 7 (7A) (Bathroom 1) (xi) Flats B, 7/F to 12/F, 15/F to 16/F, 18/F to 23/F, 25/F to 33/F, 35/F to 39/F, 41/F to 43/F, 45/F to 53/F & 55/F to 62/F, Tower 7 (7B) (Bathroom 1) (xii) Flats C, 7/F to 12/F, 15/F to 16/F, 18/F to 23/F, 25/F to 33/F, 35/F to 39/F, 41/F to 43/F, 45/F to 53/F & 55/F to 62/F, Tower 7 (7B) (Bathroom) (xiii) Flats D, 7/F to 12/F, 15/F to 16/F, 18/F to 23/F, 25/F to 33/F, 35/F to 39/F, 41/F to 43/F, 45/F to 53/F & 55/F to 61/F, Tower 7 (7B) (Bathroom 1) (xiv) Flats E, 7/F to 12/F, 15/F to 16/F, 18/F to 23/F, 25/F to 33/F, 35/F to 39/F, 41/F to 43/F, 45/F to 53/F & 55/F to 61/F, Tower 7 (7B) (Bathroom)

3. 室內裝置	
細項	描述
(a) 門	<p>浴室</p> <ul style="list-style-type: none"> - 以下住宅物業浴室選用空心木門配膠板飾面，裝設木百葉、門鎖及門擋： (i) 第5座 (5A)，7樓至12樓、15樓至16樓、18樓至23樓、25樓至33樓、35樓至39樓、41樓至43樓、45樓至53樓及55樓至62樓B單位 (浴室1) (ii) 第5座 (5A)，7樓至12樓、15樓至16樓、18樓至23樓、25樓至33樓、35樓至39樓、41樓至43樓、45樓至53樓及55樓至62樓E單位 (浴室) (iii) 第5座 (5A)，62樓A單位 (浴室2) (iv) 第5座 (5B)，7樓至12樓、15樓至16樓、18樓至23樓、25樓至33樓、35樓至39樓、41樓至43樓、45樓至53樓及55樓至61樓A單位 (浴室1) (v) 第5座 (5B)，62樓A單位 (浴室1及浴室2) (vi) 第6座 (6A)，7樓至12樓、15樓至16樓、18樓至23樓、25樓至33樓、35樓至39樓、41樓至43樓、45樓至53樓及55樓至61樓A單位 (浴室1) (vii) 第6座 (6A)，7樓至12樓、15樓至16樓、18樓至23樓、25樓至33樓、35樓至39樓、41樓至43樓、45樓至53樓及55樓至61樓B單位 (浴室1) (viii) 第6座 (6B)，41樓至43樓、45樓至53樓及55樓至62樓C單位 (浴室1) (ix) 第7座 (7A)，7樓至12樓、15樓至16樓、18樓至23樓、25樓至33樓、35樓至39樓、41樓至43樓、45樓至53樓及55樓至61樓A單位 (浴室1) (x) 第7座 (7A)，7樓至12樓、15樓至16樓、18樓至23樓、25樓至33樓、35樓至39樓、41樓至43樓、45樓至53樓及55樓至61樓B單位 (浴室1) (xi) 第7座 (7B)，7樓至12樓、15樓至16樓、18樓至23樓、25樓至33樓、35樓至39樓、41樓至43樓、45樓至53樓及55樓至62樓B單位 (浴室1) (xii) 第7座 (7B)，7樓至12樓、15樓至16樓、18樓至23樓、25樓至33樓、35樓至39樓、41樓至43樓、45樓至53樓及55樓至62樓C單位 (浴室) (xiii) 第7座 (7B)，7樓至12樓、15樓至16樓、18樓至23樓、25樓至33樓、35樓至39樓、41樓至43樓、45樓至53樓及55樓至61樓D單位 (浴室1) (xiv) 第7座 (7B)，7樓至12樓、15樓至16樓、18樓至23樓、25樓至33樓、35樓至39樓、41樓至43樓、45樓至53樓及55樓至61樓E單位 (浴室)

Fittings, finishes and appliances

裝置、裝修物料及設備

3. Interior Fittings	
Item	Description
(a) Doors	<p>Bathroom</p> <ul style="list-style-type: none"> - Hollow core timber door finished with plastic laminate, fitted with lockset and door stopper for bathrooms in the following residential properties: <ul style="list-style-type: none"> (i) Flats A, 7/F to 12/F, 15/F to 16/F, 18/F to 23/F, 25/F to 33/F, 35/F to 39/F, 41/F to 43/F, 45/F to 53/F & 55/F to 61/F, Tower 5 (5A) (Bathroom 1) (ii) Flat A, 62/F, Tower 5 (5A) (Bathroom 1) (iii) Flat A, 62/F, Tower 5 (5B) (Bathroom 3) (iv) Flats B, 7/F to 12/F, 15/F to 16/F, 18/F to 23/F, 25/F to 33/F, 35/F to 39/F, 41/F to 43/F, 45/F to 53/F & 55/F to 61/F, Tower 5 (5B) (Bathroom 1) (v) Flat A, 62/F, Tower 6 (6A) (Bathroom 1, Bathroom 2 & Bathroom 3) (vi) Flats A, 7/F to 12/F, 15/F to 16/F, 18/F to 23/F, 25/F to 33/F, 35/F to 39/F, 41/F to 43/F, 45/F to 53/F & 55/F to 62/F, Tower 6 (6B) (Bathroom 1) (vii) Flat A, 62/F, Tower 7 (7A) (Bathroom 1, Bathroom 2 & Bathroom 3) (viii) Flats A, 7/F to 12/F, 15/F to 16/F, 18/F to 23/F, 25/F to 33/F, 35/F to 39/F, 41/F to 43/F, 45/F to 53/F & 55/F to 62/F, Tower 7 (7B) (Bathroom 1) (ix) Flat D, 62/F, Tower 7 (7B) (Bathroom 1)

3. 室內裝置	
細項	描述
(a) 門	<p>浴室</p> <ul style="list-style-type: none"> - 以下住宅物業浴室選用空心木門配膠板飾面，裝設門鎖及門擋： <ul style="list-style-type: none"> (i) 第5座 (5A)，7樓至12樓、15樓至16樓、18樓至23樓、25樓至33樓、35樓至39樓、41樓至43樓、45樓至53樓及55樓至61樓A單位 (浴室1) (ii) 第5座 (5A)，62樓A單位 (浴室1) (iii) 第5座 (5B)，62樓A單位 (浴室3) (iv) 第5座 (5B)，7樓至12樓、15樓至16樓、18樓至23樓、25樓至33樓、35樓至39樓、41樓至43樓、45樓至53樓及55樓至61樓B單位 (浴室1) (v) 第6座 (6A)，62樓A單位(浴室1、浴室2及浴室3) (vi) 第6座 (6B)，7樓至12樓、15樓至16樓、18樓至23樓、25樓至33樓、35樓至39樓、41樓至43樓、45樓至53樓及55樓至62樓A單位 (浴室1) (vii) 第7座 (7A)，62樓A單位(浴室1、浴室2及浴室3) (viii) 第7座 (7B)，7樓至12樓、15樓至16樓、18樓至23樓、25樓至33樓、35樓至39樓、41樓至43樓、45樓至53樓及55樓至62樓A單位 (浴室1) (ix) 第7座 (7B)，62樓D單位 (浴室1)

Fittings, finishes and appliances

裝置、裝修物料及設備

3. Interior Fittings	
Item	Description
(a) Doors	<p>Bathroom</p> <ul style="list-style-type: none"> - Hollow core timber door finished with plastic laminate, fitted with timber louvre, lockset and handle for bathrooms in the following residential properties: (i) Flats B, 7/F to 12/F, 15/F to 16/F, 18/F to 23/F, 25/F to 33/F, 35/F to 39/F, 41/F to 43/F, 45/F to 53/F & 55/F to 62/F, Tower 5 (5A) (Bathroom 2) (ii) Flats C, 7/F to 12/F, 15/F to 16/F, 18/F to 23/F, 25/F to 33/F, 35/F to 39/F, 41/F to 43/F, 45/F to 53/F & 55/F to 61/F, Tower 5 (5A) (Bathroom) (iii) Flats D, 7/F to 12/F, 15/F to 16/F, 18/F to 23/F, 25/F to 33/F, 35/F to 39/F, 41/F to 43/F, 45/F to 53/F & 55/F to 62/F, Tower 5 (5A) (Bathroom) (iv) Flats A, 7/F to 12/F, 15/F to 16/F, 18/F to 23/F, 25/F to 33/F, 35/F to 39/F, 41/F to 43/F, 45/F to 53/F & 55/F to 61/F, Tower 5 (5B) (Bathroom 2) (v) Flats C, 7/F to 12/F, 15/F to 16/F, 18/F to 23/F, 25/F to 33/F, 35/F to 39/F, 41/F to 43/F, 45/F to 53/F & 55/F to 62/F, Tower 5 (5B) (Bathroom) (vi) Flats D, 7/F to 12/F, 15/F to 16/F, 18/F to 23/F, 25/F to 33/F, 35/F to 39/F, 41/F to 43/F, 45/F to 53/F & 55/F to 62/F, Tower 5 (5B) (Bathroom) (vii) Flats A, 7/F to 12/F, 15/F to 16/F, 18/F to 23/F, 25/F to 33/F, 35/F to 39/F, 41/F to 43/F, 45/F to 53/F & 55/F to 61/F, Tower 6 (6A) (Bathroom 2) (viii) Flats B, 7/F to 12/F, 15/F to 16/F, 18/F to 23/F, 25/F to 33/F, 35/F to 39/F, 41/F to 43/F, 45/F to 53/F & 55/F to 61/F, Tower 6 (6A) (Bathroom 2) (ix) Flats C, 7/F to 12/F, 15/F to 16/F, 18/F to 23/F, 25/F to 33/F, 35/F to 39/F, 41/F to 43/F, 45/F to 53/F & 55/F to 62/F, Tower 6 (6A) (Bathroom) (x) Flats D, 7/F to 12/F, 15/F to 16/F, 18/F to 23/F, 25/F to 33/F, 35/F to 39/F, 41/F to 43/F, 45/F to 53/F & 55/F to 62/F, Tower 6 (6A) (Bathroom) (xi) Flats C, 7/F to 12/F, 15/F to 16/F, 18/F to 23/F, 25/F to 33/F & 35/F to 39/F, Tower 6 (6B) (Bathroom) (xii) Flats C, 41/F to 43/F, 45/F to 53/F & 55/F to 62/F, Tower 6 (6B) (Bathroom 2) (xiii) Flats D, 7/F to 12/F, 15/F to 16/F, 18/F to 23/F, 25/F to 33/F & 35/F to 39/F, Tower 6 (6B) (Bathroom) (xiv) Flats E, 7/F to 12/F, 15/F to 16/F, 18/F to 23/F, 25/F to 33/F, 35/F to 39/F, 41/F to 43/F, 45/F to 53/F & 55/F to 62/F, Tower 6 (6B) (Bathroom) (xv) Flats A, 7/F to 12/F, 15/F to 16/F, 18/F to 23/F, 25/F to 33/F, 35/F to 39/F, 41/F to 43/F, 45/F to 53/F & 55/F to 61/F, Tower 7 (7A) (Bathroom 2) (xvi) Flats B, 7/F to 12/F, 15/F to 16/F, 18/F to 23/F, 25/F to 33/F, 35/F to 39/F, 41/F to 43/F, 45/F to 53/F & 55/F to 61/F, Tower 7 (7A) (Bathroom 2) (xvii) Flats D, 7/F to 12/F, 15/F to 16/F, 18/F to 23/F, 25/F to 33/F, 35/F to 39/F, 41/F to 43/F, 45/F to 53/F & 55/F to 62/F, Tower 7 (7A) (Bathroom) (xviii) Flats E, 7/F to 12/F, 15/F to 16/F, 18/F to 23/F, 25/F to 33/F, 35/F to 39/F, 41/F to 43/F, 45/F to 53/F & 55/F to 62/F, Tower 7 (7A) (Bathroom) (xix) Flats F, 7/F to 12/F, 15/F to 16/F, 18/F to 23/F, 25/F to 33/F, 35/F to 39/F, 41/F to 43/F, 45/F to 53/F & 55/F to 62/F, Tower 7 (7A) (Bathroom) (xx) Flats B, 7/F to 12/F, 15/F to 16/F, 18/F to 23/F, 25/F to 33/F, 35/F to 39/F, 41/F to 43/F, 45/F to 53/F & 55/F to 62/F, Tower 7 (7B) (Bathroom 2) (xxi) Flats D, 7/F to 12/F, 15/F to 16/F, 18/F to 23/F, 25/F to 33/F, 35/F to 39/F, 41/F to 43/F, 45/F to 53/F & 55/F to 61/F, Tower 7 (7B) (Bathroom 2) (xxii) Flat D, 62/F, Tower 7 (7B) (Bathroom 2)

3. 室內裝置	
細項	描述
(a) 門	<p>浴室</p> <ul style="list-style-type: none"> - 以下住宅物業浴室選用空心木門配膠板飾面，裝設木百葉、門鎖及手抽： (i) 第5座 (5A)，7樓至12樓、15樓至16樓、18樓至23樓、25樓至33樓、35樓至39樓、41樓至43樓、45樓至53樓及55樓至62樓B單位 (浴室2) (ii) 第5座 (5A)，7樓至12樓、15樓至16樓、18樓至23樓、25樓至33樓、35樓至39樓、41樓至43樓、45樓至53樓及55樓至61樓C單位 (浴室) (iii) 第5座 (5A)，7樓至12樓、15樓至16樓、18樓至23樓、25樓至33樓、35樓至39樓、41樓至43樓、45樓至53樓及55樓至62樓D單位 (浴室) (iv) 第5座 (5B)，7樓至12樓、15樓至16樓、18樓至23樓、25樓至33樓、35樓至39樓、41樓至43樓、45樓至53樓及55樓至61樓A單位 (浴室2) (v) 第5座 (5B)，7樓至12樓、15樓至16樓、18樓至23樓、25樓至33樓、35樓至39樓、41樓至43樓、45樓至53樓及55樓至62樓C單位 (浴室) (vi) 第5座 (5B)，7樓至12樓、15樓至16樓、18樓至23樓、25樓至33樓、35樓至39樓、41樓至43樓、45樓至53樓及55樓至62樓D單位 (浴室) (vii) 第6座 (6A)，7樓至12樓、15樓至16樓、18樓至23樓、25樓至33樓、35樓至39樓、41樓至43樓、45樓至53樓及55樓至61樓A單位 (浴室2) (viii) 第6座 (6A)，7樓至12樓、15樓至16樓、18樓至23樓、25樓至33樓、35樓至39樓、41樓至43樓、45樓至53樓及55樓至61樓B單位 (浴室2) (ix) 第6座 (6A)，7樓至12樓、15樓至16樓、18樓至23樓、25樓至33樓、35樓至39樓、41樓至43樓、45樓至53樓及55樓至62樓C單位 (浴室) (x) 第6座 (6A)，7樓至12樓、15樓至16樓、18樓至23樓、25樓至33樓、35樓至39樓、41樓至43樓、45樓至53樓及55樓至62樓D單位 (浴室) (xi) 第6座 (6B)，7樓至12樓、15樓至16樓、18樓至23樓、25樓至33樓及35樓至39樓C單位 (浴室) (xii) 第6座 (6B)，41樓至43樓、45樓至53樓及55樓至62樓C單位 (浴室2) (xiii) 第6座 (6B)，7樓至12樓、15樓至16樓、18樓至23樓、25樓至33樓及35樓至39樓D單位 (浴室) (xiv) 第6座 (6B)，7樓至12樓、15樓至16樓、18樓至23樓、25樓至33樓、35樓至39樓、41樓至43樓、45樓至53樓及55樓至62樓E單位 (浴室) (xv) 第7座 (7A)，7樓至12樓、15樓至16樓、18樓至23樓、25樓至33樓、35樓至39樓、41樓至43樓、45樓至53樓及55樓至61樓A單位 (浴室2) (xvi) 第7座 (7A)，7樓至12樓、15樓至16樓、18樓至23樓、25樓至33樓、35樓至39樓、41樓至43樓、45樓至53樓及55樓至61樓B單位 (浴室2) (xvii) 第7座 (7A)，7樓至12樓、15樓至16樓、18樓至23樓、25樓至33樓、35樓至39樓、41樓至43樓、45樓至53樓及55樓至62樓D單位 (浴室) (xviii) 第7座 (7A)，7樓至12樓、15樓至16樓、18樓至23樓、25樓至33樓、35樓至39樓、41樓至43樓、45樓至53樓及55樓至62樓E單位 (浴室) (xix) 第7座 (7A)，7樓至12樓、15樓至16樓、18樓至23樓、25樓至33樓、35樓至39樓、41樓至43樓、45樓至53樓及55樓至62樓F單位 (浴室) (xx) 第7座 (7B)，7樓至12樓、15樓至16樓、18樓至23樓、25樓至33樓、35樓至39樓、41樓至43樓、45樓至53樓及55樓至62樓B單位 (浴室2) (xxi) 第7座 (7B)，7樓至12樓、15樓至16樓、18樓至23樓、25樓至33樓、35樓至39樓、41樓至43樓、45樓至53樓及55樓至61樓D單位 (浴室2) (xxii) 第7座 (7B)，7樓至12樓、15樓至16樓、18樓至23樓、25樓至33樓、35樓至39樓、41樓至43樓、45樓至53樓及55樓至61樓D單位 (浴室2) (xxiii) 第7座 (7B)，62樓D單位 (浴室2)

Fittings, finishes and appliances

裝置、裝修物料及設備

3. Interior Fittings	
Item	Description
(a) Doors	<p>Bathroom</p> <ul style="list-style-type: none"> Hollow core timber door finished with plastic laminate, fitted with lockset and handle for bathrooms in the other residential properties. <p>(13/F, 14/F, 24/F, 34/F, 44/F & 54/F of Tower 5 (5A & 5B) are omitted.) (13/F, 14/F, 24/F, 34/F, 44/F & 54/F of Tower 6 (6A & 6B) are omitted.) (13/F, 14/F, 24/F, 34/F, 44/F & 54/F of Tower 7 (7A & 7B) are omitted.)</p> <p>Store</p> <ul style="list-style-type: none"> Hollow core timber door finished with plastic laminate, fitted with lockset and door stopper, except store in the following residential properties, provided with hollow core timber door finished with plastic laminate, fitted with lockset and handle: <ul style="list-style-type: none"> (i) Flats B, 7/F to 12/F, 15/F to 16/F, 18/F to 23/F, 25/F to 33/F, 35/F to 39/F, 41/F to 43/F, 45/F to 53/F & 55/F to 62/F, Tower 5 (5A) (ii) Flats B, 7/F to 12/F, 15/F to 16/F, 18/F to 23/F, 25/F to 33/F, 35/F to 39/F, 41/F to 43/F, 45/F to 53/F & 55/F to 61/F, Tower 6 (6A) (iii) Flat C, 62/F, Tower 6 (6B) (iv) Flats B, 7/F to 12/F, 15/F to 16/F, 18/F to 23/F, 25/F to 33/F, 35/F to 39/F, 41/F to 43/F, 45/F to 53/F & 55/F to 62/F, Tower 7 (7B) <p>(13/F, 14/F, 24/F, 34/F, 44/F & 54/F of Tower 5 (5A & 5B) are omitted.) (13/F, 14/F, 24/F, 34/F, 44/F & 54/F of Tower 6 (6A & 6B) are omitted.) (13/F, 14/F, 24/F, 34/F, 44/F & 54/F of Tower 7 (7A & 7B) are omitted.)</p> <p>Toilet</p> <ul style="list-style-type: none"> Fluorocarbon coated aluminium frame door fitted with lockset. <p>Balcony / Utility Platform / Flat Roof</p> <ul style="list-style-type: none"> Fluorocarbon coated aluminium frame door fitted with obscured glass, lockset and door stop for utility platform at Flat A, 62/F, Tower 6 (6A) and Flat A, 62/F, Tower 7 (7A). Fluorocarbon coated aluminium frame door fitted with tinted glass and lockset for flat roof at Flat D, 62/F, Tower 7 (7B). Fluorocarbon coated aluminium frame door fitted with tinted glass, lockset and door stopper for balcony, utility platform and flat roof in the other residential properties. <p>Door access from 62/F to roof (Flat A, 62/F, Tower 5 (5A), Flat A, 62/F, Tower 5 (5B), Flat A, 62/F, Tower 6 (6A), Flat A, 62/F, Tower 7 (7A) and Flat D, 62/F, Tower 7 (7B))</p> <ul style="list-style-type: none"> Fluorocarbon coated aluminium frame door fitted with tinted glass, lockset and door stopper.

3. 室內裝置	
細項	描述
(a) 門	<p>浴室</p> <ul style="list-style-type: none"> 其他住宅物業浴室選用空心木門配膠板飾面，裝設門鎖及門抽。 <p>(第5座 (5A及5B)不設13樓、14樓、24樓、34樓、44樓及54樓。) (第6座 (6A及6B)不設13樓、14樓、24樓、34樓、44樓及54樓。) (第7座 (7A及7B)不設13樓、14樓、24樓、34樓、44樓及54樓。)</p> <p>儲物房</p> <ul style="list-style-type: none"> 空心木門配膠板飾面，裝設門鎖及門擋，除以下住宅物業之儲物房選用空心木門配膠板飾面，裝設門鎖及門抽： <ul style="list-style-type: none"> (i) 第5座 (5A)，7樓至12樓、15樓至16樓、18樓至23樓、25樓至33樓、35樓至39樓、41樓至43樓、45樓至53樓及55樓至62樓B單位 (ii) 第6座 (6A)，7樓至12樓、15樓至16樓、18樓至23樓、25樓至33樓、35樓至39樓、41樓至43樓、45樓至53樓及55樓至61樓B單位 (iii) 第6座 (6B)，62樓C單位 (iv) 第7座 (7B)，7樓至12樓、15樓至16樓、18樓至23樓、25樓至33樓、35樓至39樓、41樓至43樓、45樓至53樓及55樓至62樓B單位 <p>(第5座 (5A及5B)不設13樓、14樓、24樓、34樓、44樓及54樓。) (第6座 (6A及6B)不設13樓、14樓、24樓、34樓、44樓及54樓。) (第7座 (7A及7B)不設13樓、14樓、24樓、34樓、44樓及54樓。)</p> <p>洗手間</p> <ul style="list-style-type: none"> 選用氟化碳噴塗鋁框門裝設門鎖。 <p>露台 / 工作平台 / 平台</p> <ul style="list-style-type: none"> 第6座 (6A)，62樓A單位及第7座 (7A)，62樓A單位之工作平台選用氟化碳噴塗鋁框門配磨砂玻璃、門鎖及門擋。 第7座 (7B)，62樓D單位平台選用氟化碳噴塗鋁框門配有色玻璃及門鎖。 其他住宅物業內之露台、工作平台及平台選用氟化碳噴塗鋁框門配有色玻璃、門鎖及門擋。 <p>由62樓通往於天台的門 (第5座 (5A)，62樓A單位；第5座 (5B)，62樓A單位；第6座 (6A)，62樓A單位；第7座 (7A)，62樓A單位；第7座 (7B)，62樓D單位)</p> <ul style="list-style-type: none"> 選用氟化碳噴塗鋁框門配有色玻璃、門鎖及門擋。

Fittings, finishes and appliances

裝置、裝修物料及設備

3. Interior Fittings	
Item	Description
(b) Bathroom	<ul style="list-style-type: none"> - Timber vanity counter finished plastic laminate, natural stone and metal with natural stone countertop. - Timber mirror cabinet finished with wooden veneer and metal trimming. - Timber cabinet finished with plastic laminate except bathrooms in the following residential properties are not provided with timber cabinet : <ul style="list-style-type: none"> (i) Flats A, 7/F to 12/F, 15/F to 16/F, 18/F to 23/F, 25/F to 33/F, 35/F to 39/F, 41/F to 43/F, 45/F to 53/F & 55/F to 61/F, Tower 5 (5A) (Bathroom 1) (ii) Flat A, 62/F, Tower 5 (5A)(Bathroom 1 and Bathroom 2) (iii) Flats B, 7/F to 12/F, 15/F to 16/F, 18/F to 23/F, 25/F to 33/F, 35/F to 39/F, 41/F to 43/F, 45/F to 53/F & 55/F to 62/F, Tower 5 (5A) (Bathroom 1) (iv) Flats A, 7/F to 12/F, 15/F to 16/F, 18/F to 23/F, 25/F to 33/F, 35/F to 39/F, 41/F to 43/F, 45/F to 53/F & 55/F to 61/F, Tower 5 (5B) (Bathroom 1) (v) Flat A, 62/F, Tower 5 (5B)(Bathroom 1, Bathroom 2 and Bathroom 3) (vi) Flats B, 7/F to 12/F, 15/F to 16/F, 18/F to 23/F, 25/F to 33/F, 35/F to 39/F, 41/F to 43/F, 45/F to 53/F & 55/F to 61/F, Tower 5 (5B) (Bathroom 1) (vii) Flats A, 7/F to 12/F, 15/F to 16/F, 18/F to 23/F, 25/F to 33/F, 35/F to 39/F, 41/F to 43/F, 45/F to 53/F & 55/F to 61/F, Tower 6 (6A) (Bathroom 1) (viii) Flat A, 62/F, Tower 6 (6A)(Bathroom 1, Bathroom 2 and Bathroom 3) (ix) Flats B, 7/F to 12/F, 15/F to 16/F, 18/F to 23/F, 25/F to 33/F, 35/F to 39/F, 41/F to 43/F, 45/F to 53/F & 55/F to 61/F, Tower 6 (6A) (Bathroom 1) (x) Flats A, 7/F to 12/F, 15/F to 16/F, 18/F to 23/F, 25/F to 33/F, 35/F to 39/F, 41/F to 43/F, 45/F to 53/F & 55/F to 62/F, Tower 6 (6B) (Bathroom 1) (xi) Flats C, 41/F to 43/F, 45/F to 53/F & 55/F to 62/F, Tower 6 (6B) (Bathroom 1) (xii) Flats A, 7/F to 12/F, 15/F to 16/F, 18/F to 23/F, 25/F to 33/F, 35/F to 39/F, 41/F to 43/F, 45/F to 53/F & 55/F to 61/F, Tower 7 (7A) (Bathroom 1) (xiii) Flat A, 62/F, Tower 7 (7A)(Bathroom 1, Bathroom 2 and Bathroom 3) (xiv) Flats B, 7/F to 12/F, 15/F to 16/F, 18/F to 23/F, 25/F to 33/F, 35/F to 39/F, 41/F to 43/F, 45/F to 53/F & 55/F to 61/F, Tower 7 (7A) (Bathroom 1) (xv) Flats A, 7/F to 12/F, 15/F to 16/F, 18/F to 23/F, 25/F to 33/F, 35/F to 39/F, 41/F to 43/F, 45/F to 53/F & 55/F to 62/F, Tower 7 (7B) (Bathroom 1) (xvi) Flats B, 7/F to 12/F, 15/F to 16/F, 18/F to 23/F, 25/F to 33/F, 35/F to 39/F, 41/F to 43/F, 45/F to 53/F & 55/F to 62/F, Tower 7 (7B) (Bathroom 1) (xvii) Flats D, 7/F to 12/F, 15/F to 16/F, 18/F to 23/F, 25/F to 33/F, 35/F to 39/F, 41/F to 43/F, 45/F to 53/F & 55/F to 61/F, Tower 7 (7B) (Bathroom 1) (xviii) Flat D, 62/F, Tower 7 (7B)(Bathroom 1 and Bathroom 2)

3. 室內裝置	
細項	描述
(b) 浴室	<ul style="list-style-type: none"> - 木面盆櫃配膠板飾面、天然石及金屬配天然石檯面。 - 木鏡櫃配木飾面及金屬條。 - 木櫃配膠板飾面除以下住宅物業之浴室不設木櫃： <ul style="list-style-type: none"> (i) 第5座(5A)，7樓至12樓、15樓至16樓、18樓至23樓、25樓至33樓、35樓至39樓、41樓至43樓、45樓至53樓及55樓至61樓A單位(浴室1) (ii) 第5座(5A)，62樓A單位(浴室1及浴室2) (iii) 第5座(5A)，7樓至12樓、15樓至16樓、18樓至23樓、25樓至33樓、35樓至39樓、41樓至43樓、45樓至53樓及55樓至62樓B單位(浴室1) (iv) 第5座(5B)，7樓至12樓、15樓至16樓、18樓至23樓、25樓至33樓、35樓至39樓、41樓至43樓、45樓至53樓及55樓至61樓A單位(浴室1) (v) 第5座(5B)，62樓A單位(浴室1、浴室2及浴室3) (vi) 第5座(5B)，7樓至12樓、15樓至16樓、18樓至23樓、25樓至33樓、35樓至39樓、41樓至43樓、45樓至53樓及55樓至61樓B單位(浴室1) (vii) 第6座(6A)，7樓至12樓、15樓至16樓、18樓至23樓、25樓至33樓、35樓至39樓、41樓至43樓、45樓至53樓及55樓至61樓A單位(浴室1) (viii) 第6座(6A)，62樓A單位(浴室1、浴室2及浴室3) (ix) 第6座(6A)，7樓至12樓、15樓至16樓、18樓至23樓、25樓至33樓、35樓至39樓、41樓至43樓、45樓至53樓及55樓至61樓B單位(浴室1) (x) 第6座(6B)，7樓至12樓、15樓至16樓、18樓至23樓、25樓至33樓、35樓至39樓、41樓至43樓、45樓至53樓及55樓至62樓A單位(浴室1) (xi) 第6座(6B)，41樓至43樓、45樓至53樓及55樓至62樓C單位(浴室1) (xii) 第7座(7A)，7樓至12樓、15樓至16樓、18樓至23樓、25樓至33樓、35樓至39樓、41樓至43樓、45樓至53樓及55樓至61樓A單位(浴室1) (xiii) 第7座(7A)，62樓A單位(浴室1、浴室2及浴室3) (xiv) 第7座(7A)，7樓至12樓、15樓至16樓、18樓至23樓、25樓至33樓、35樓至39樓、41樓至43樓、45樓至53樓及55樓至61樓B單位(浴室1) (xv) 第7座(7B)，7樓至12樓、15樓至16樓、18樓至23樓、25樓至33樓、35樓至39樓、41樓至43樓、45樓至53樓及55樓至62樓A單位(浴室1) (xvi) 第7座(7B)，7樓至12樓、15樓至16樓、18樓至23樓、25樓至33樓、35樓至39樓、41樓至43樓、45樓至53樓及55樓至62樓B單位(浴室1) (xvii) 第7座(7B)，7樓至12樓、15樓至16樓、18樓至23樓、25樓至33樓、35樓至39樓、41樓至43樓、45樓至53樓及55樓至61樓D單位(浴室1) (xviii) 第7座(7B)，62樓D單位(浴室1及浴室2)

Fittings, finishes and appliances

裝置、裝修物料及設備

3. Interior Fittings	
Item	Description
(b) Bathroom	<ul style="list-style-type: none"> - Vitreous china water closet. - Vitreous china wash basin with metal wash basin mixer. - Metal toilet paper holder and metal hook. - Tempered glass shower cubicle and metal shower mixer provided for all bathrooms with shower cubicles. - Steel enamel bathtub (1500mm(L) x 700mm(W) x 390mm(D)) with metal bathtub mixer provided for all bathrooms with bathtub and metal towel rail. - Ventilation system is provided. - Copper pipes are used for cold and hot water supply system. - uPVC pipes are used for flushing water system. - Manually operated roller blind with fiber for Bathroom 1 in the following residential property <ul style="list-style-type: none"> (i) Flat A, 62/F, Tower5(5A) (Bathroom 1) <p>(13/F, 14/F, 24/F, 34/F, 44/F & 54/F of Tower 5 (5A & 5B) are omitted.) (13/F, 14/F, 24/F, 34/F, 44/F & 54/F of Tower 6 (6A & 6B) are omitted.) (13/F, 14/F, 24/F, 34/F, 44/F & 54/F of Tower 7 (7A & 7B) are omitted.)</p>
(c) Kitchen	<ul style="list-style-type: none"> - Acrylic solid surface sink with metal sink mixer. - Copper pipes are used for cold and hot water supply system. - Timber kitchen cabinet finished with plastic laminate and acrylic solid surface countertop, fitted with high gloss lacquer and plastic laminate timber door panels. - Fire service installations and equipment for the residential property with open kitchen: Sprinkler head(s) installed in or near open kitchen; and sounder-base smoke detector installed at ceiling near open kitchen. - For appliances provision, please refer to the "Appliances Schedule". - Ventilation system is provided for kitchen except open kitchen.
(d) Bedroom	<ul style="list-style-type: none"> - Manually operated sheer is provided.
(e) Telephone	<ul style="list-style-type: none"> - Telephone connection points are provided. - For location and number of connection points, please refer to the "Schedule of Mechanical & Electrical Provisions of Residential Properties".
(f) Aerials	<ul style="list-style-type: none"> - TV/FM outlets for local TV/FM programs are provided. - For location and number of connection points, please refer to the "Schedule of Mechanical & Electrical Provisions of Residential Properties".

3. 室內裝置	
細項	描述
(b) 浴室	<ul style="list-style-type: none"> - 陶瓷坐廁。 - 陶瓷洗手盆配金屬水龍頭。 - 金屬廁紙架及金屬掛鉤。 - 所有設有淋浴間的浴室，均有強化玻璃淋浴間隔及設有金屬淋浴花灑套裝。 - 所有設有浴缸的浴室，均裝設 (1500毫米(長) x 700毫米(闊) x 390毫米(深)) 鋼釉浴缸配金屬浴缸水龍頭及金屬毛巾桿。 - 設有通風系統。 - 冷熱水供水系統採用銅喉管。 - 沖廁供水系統採用膠喉管。 - 以下住宅物業浴室1設有手動纖維捲簾 <ul style="list-style-type: none"> (i) 第5座(5A), 62樓A單位 (浴室1) <p>(第5座 (5A及5B)不設13樓、14樓、24樓、34樓、44樓及54樓。) (第6座 (6A及6B)不設13樓、14樓、24樓、34樓、44樓及54樓。) (第7座 (7A及7B)不設13樓、14樓、24樓、34樓、44樓及54樓。)</p>
(c) 廚房	<ul style="list-style-type: none"> - 人造石洗滌盆配金屬洗滌盆水龍頭。 - 冷熱水供水系統採用銅喉管。 - 木廚櫃組合配膠板飾面及人造石檯面另配高光漆面及膠板飾面木門板。 - 設有開放式廚房的住宅物業之消防裝置及設備：消防花灑頭安裝在開放式廚房內或附近；及配置聲響警報基座煙霧探測器安裝在開放式廚房附近的天花。 - 有關供應之設備，請參閱「設備說明表」。 - 除開放式廚房外，所有廚房設有通風系統。
(d) 睡房	<ul style="list-style-type: none"> - 設有手動窗紗。
(e) 電話	<ul style="list-style-type: none"> - 裝設有電話插座。 - 有關接駁點的位置及數量，請參考「住宅物業機電裝置數量說明表」。
(f) 天線	<ul style="list-style-type: none"> - 裝設有接收本地電視節目及電台節目的電視/ 收音機天線插座。 - 有關接駁點的位置及數量，請參考「住宅物業機電裝置數量說明表」。

Fittings, finishes and appliances

裝置、裝修物料及設備

3. Interior Fittings	
Item	Description
(g) Electrical installations	<ul style="list-style-type: none"> - Three-phase or single-phase electricity supply with miniature circuit breaker distribution board is provided. - Single-phase electricity supply located at Flats B & D, 7/F to 12/F, 15/F to 16/F, 18/F to 23/F, 25/F to 33/F, 35/F to 39/F, 41/F to 43/F, 45/F to 53/F & 55/F to 62/F, Tower 5 (5A) - Single-phase electricity supply located at Flats C & D, 7/F to 12/F, 15/F to 16/F, 18/F to 23/F, 25/F to 33/F, 35/F to 39/F, 41/F to 43/F, 45/F to 53/F & 55/F to 62/F, Tower 5 (5B) - Three-phase electricity supply located at Flats A, C & E, 7/F to 12/F, 15/F to 16/F, 18/F to 23/F, 25/F to 33/F, 35/F to 39/F, 41/F to 43/F, 45/F to 53/F & 55/F to 61/F, Tower 5 (5A) - Three-phase electricity supply located at Flats A & E, 62/F, Tower 5 (5A) - Three-phase electricity supply located at Flats A & B, 7/F to 12/F, 15/F to 16/F, 18/F to 23/F, 25/F to 33/F, 35/F to 39/F, 41/F to 43/F, 45/F to 53/F & 55/F to 61/F, Tower 5 (5B) - Three-phase electricity supply located at Flat A, 62/F, Tower 5 (5B) - Single-phase electricity supply located at Flats B & E, 7/F to 12/F, 15/F to 16/F, 18/F to 23/F, 25/F to 33/F, 35/F to 39/F, 41/F to 43/F, 45/F to 53/F & 55/F to 61/F, Tower 6 (6A) - Single-phase electricity supply located at Flat E, 62/F, Tower 6 (6A) - Single-phase electricity supply located at Flats C & F, 7/F to 12/F, 15/F to 16/F, 18/F to 23/F, 25/F to 33/F & 35/F to 39/F, Tower 6 (6B) - Single-phase electricity supply located at Flat F, 41/F to 43/F, 45/F to 53/F & 55/F to 62/F, Tower 6 (6B) - Three-phase electricity supply located at Flats A, C & D, 7/F to 12/F, 15/F to 16/F, 18/F to 23/F, 25/F to 33/F, 35/F to 39/F, 41/F to 43/F, 45/F to 53/F & 55/F to 62/F, Tower 6 (6A) - Three-phase electricity supply located at Flats A, D & E, 7/F to 12/F, 15/F to 16/F, 18/F to 23/F, 25/F to 33/F & 35/F to 39/F, Tower 6 (6B) - Three-phase electricity supply located at Flats A, C & E, 41/F to 43/F, 45/F to 53/F & 55/F to 62/F, Tower 6 (6B) - Single-phase electricity supply located at Flat C, 7/F to 12/F, 15/F to 16/F, 18/F to 23/F, 25/F to 33/F, 35/F to 39/F, 41/F to 43/F, 45/F to 53/F & 55/F to 62/F, Tower 7 (7A) - Single-phase electricity supply located at Flats B & E, 7/F to 12/F, 15/F to 16/F, 18/F to 23/F, 25/F to 33/F, 35/F to 39/F, 41/F to 43/F, 45/F to 53/F & 55/F to 61/F, Tower 7 (7B) - Single-phase electricity supply located at Flat B, 62/F, Tower 7 (7B) - Three-phase electricity supply located at Flats A, B, D, E & F, 7/F to 12/F, 15/F to 16/F, 18/F to 23/F, 25/F to 33/F, 35/F to 39/F, 41/F to 43/F, 45/F to 53/F & 55/F to 61/F, Tower 7 (7A) - Three-phase electricity supply located at Flats A, D, E & F, 62/F, Tower 7 (7A) - Three-phase electricity supply located at Flats A, C, D, 7/F to 12/F, 15/F to 16/F, 18/F to 23/F, 25/F to 33/F, 35/F to 39/F, 41/F to 43/F, 45/F to 53/F & 55/F to 62/F, Tower 7 (7B)

3. 室內裝置	
細項	描述
(g) 電力裝置	<ul style="list-style-type: none"> - 提供三相或單相電力配電箱並裝置有微型斷路器。 - 單相電力配電箱設置於第5座 (5A)，7樓至12樓、15樓至16樓、18樓至23樓、25樓至33樓、35樓至39樓、41樓至43樓、45樓至53樓及55樓至62樓B及D單位。 - 單相電力配電箱設置於第5座 (5B)，7樓至12樓、15樓至16樓、18樓至23樓、25樓至33樓、35樓至39樓、41樓至43樓、45樓至53樓及55樓至62樓C及D單位。 - 三相電力配電箱設置於第5座 (5A)，7樓至12樓、15樓至16樓、18樓至23樓、25樓至33樓、35樓至39樓、41樓至43樓、45樓至53樓及55樓至61樓A、C及E單位。 - 三相電力配電箱設置於第5座 (5A)，62樓A及E單位。 - 三相電力配電箱設置於第5座 (5B)，7樓至12樓、15樓至16樓、18樓至23樓、25樓至33樓、35樓至39樓、41樓至43樓、45樓至53樓及55樓至61樓A及B單位。 - 三相電力配電箱設置於第5座 (5B)，62樓A單位。 - 單相電力配電箱設置於第6座 (6A)，7樓至12樓、15樓至16樓、18樓至23樓、25樓至33樓、35樓至39樓、41樓至43樓、45樓至53樓及55樓至61樓B及E單位。 - 單相電力配電箱設置於第6座 (6A)，62樓E單位。 - 單相電力配電箱設置於第6座 (6B)，7樓至12樓、15樓至16樓、18樓至23樓、25樓至33樓及35樓至39樓C及F單位。 - 單相電力配電箱設置於第6座 (6B)，41樓至43樓、45樓至53樓及55樓至62樓F單位。 - 三相電力配電箱設置於第6座 (6A)，7樓至12樓、15樓至16樓、18樓至23樓、25樓至33樓、35樓至39樓、41樓至43樓、45樓至53樓及55樓至62樓A、C及D單位。 - 三相電力配電箱設置於第6座 (6B)，7樓至12樓、15樓至16樓、18樓至23樓、25樓至33樓及35樓至39樓A、D及E單位。 - 三相電力配電箱設置於第6座 (6B)，41樓至43樓、45樓至53樓及55樓至62樓A、C及E單位。 - 單相電力配電箱設置於第7座 (7A)，7樓至12樓、15樓至16樓、18樓至23樓、25樓至33樓、35樓至39樓、41樓至43樓、45樓至53樓及55樓至62樓C單位。 - 單相電力配電箱設置於第7座 (7B)，7樓至12樓、15樓至16樓、18樓至23樓、25樓至33樓、35樓至39樓、41樓至43樓、45樓至53樓及55樓至61樓B及E單位。 - 單相電力配電箱設置於第7座 (7B)，62樓B單位。 - 三相電力配電箱設置於第7座 (7A)，7樓至12樓、15樓至16樓、18樓至23樓、25樓至33樓、35樓至39樓、41樓至43樓、45樓至53樓及55樓至61樓A、B、D、E及F單位。 - 三相電力配電箱設置於第7座 (7A)，62樓A、D、E及F單位。 - 三相電力配電箱設置於第7座 (7B)，7樓至12樓、15樓至16樓、18樓至23樓、25樓至33樓、35樓至39樓、41樓至43樓、45樓至53樓及55樓至62樓A、C及D單位。

Fittings, finishes and appliances

裝置、裝修物料及設備

3. Interior Fittings	
Item	Description
(g) Electrical installations	<ul style="list-style-type: none"> - Conduits are partly concealed and partly exposed*. - For location and number of power points and air-conditioner points, please refer to the "Schedule of Mechanical & Electrical Provisions of Residential Properties". <p>* Remark: Other than those parts of the conduits concealed within concrete, the rest of them are exposed. Exposed conduits are mostly covered or hidden by false ceilings, bulkheads, cabinets, claddings, non-concrete walls, pipe ducts or other materials and are not readily visible.</p> <p>(13/F, 14/F, 24/F, 34/F, 44/F & 54/F of Tower 5 (5A & 5B) are omitted.) (13/F, 14/F, 24/F, 34/F, 44/F & 54/F of Tower 6 (6A & 6B) are omitted.) (13/F, 14/F, 24/F, 34/F, 44/F & 54/F of Tower 7 (7A & 7B) are omitted.)</p>

3. Interior Fittings	
Item	Description
(h) Gas supply	<ul style="list-style-type: none"> - Town gas supply pipes are connected to gas water heater and gas cooker hob for Flats A, B & D, 7/F to 12/F, 15/F to 16/F, 18/F to 23/F, 25/F to 33/F, 35/F to 39/F, 41/F to 43/F, 45/F to 53/F & 55/F to 61/F, Tower 5 (5A). - Town gas supply pipes are connected to gas water heater and gas cooker hob for Flats A, B, C & D, 7/F to 12/F, 15/F to 16/F, 18/F to 23/F, 25/F to 33/F, 35/F to 39/F, 41/F to 43/F, 45/F to 53/F & 55/F to 61/F, Tower 5 (5B). - Town gas supply pipes are connected to gas water heater and gas cooker hob for Flats A, B & D, 62/F, Tower 5 (5A). - Town gas supply pipes are connected to gas water heater and gas cooker hob for Flats A, C & D, 62/F, Tower 5 (5B). - Town gas supply pipes are connected to gas water heater and gas cooker hob for Flats A & B, 7/F to 12/F, 15/F to 16/F, 18/F to 23/F, 25/F to 33/F, 35/F to 39/F, 41/F to 43/F, 45/F to 53/F & 55/F to 61/F, Tower 6 (6A). - Town gas supply pipes are connected to gas water heater for Flats E, 7/F to 12/F, 15/F to 16/F, 18/F to 23/F, 25/F to 33/F, 35/F to 39/F, 41/F to 43/F, 45/F to 53/F & 55/F to 61/F, Tower 6 (6A). - Town gas supply pipes are connected to gas water heater and gas cooker hob for Flats A & C, 7/F to 12/F, 15/F to 16/F, 18/F to 23/F, 25/F to 33/F, 35/F to 39/F, 41/F to 43/F, 45/F to 53/F & 55/F to 61/F, Tower 6 (6B). - Town gas supply pipes are connected to gas water heater for Flats F, 7/F to 12/F, 15/F to 16/F, 18/F to 23/F, 25/F to 33/F, 35/F to 39/F, 41/F to 43/F, 45/F to 53/F & 55/F to 61/F, Tower 6 (6B). - Town gas supply pipes are connected to gas water heater and gas cooker hob for Flat A, 62/F, Tower 6 (6A).

3. 室內裝置	
細項	描述
(g) 電力裝置	<ul style="list-style-type: none"> - 導管是部分隱藏及部分外露*。 - 有關電插座及空調機接駁點的位置及數量，請參考「住宅物業機電裝置數量說明表」。 <p>* 備註：除部分隱藏於混凝土內之導管外，其他部分的導管均為外露。外露的導管大部分以假天花，裝飾橫樑、櫃、飾面板、非混凝土牆、管道槽或其他物料覆蓋或掩藏，並不容易看見。</p> <p>(第5座之(5A)及(5B)不設13樓、14樓、24樓、34樓、44樓及54樓。) (第6座之(6A)及(6B)不設13樓、14樓、24樓、34樓、44樓及54樓。) (第7座之(7A)及(7B)不設13樓、14樓、24樓、34樓、44樓及54樓。)</p>

3. 室內裝置	
細項	描述
(h) 氣體供應	<ul style="list-style-type: none"> - 煤氣喉接駁至第5座 (5A)，7樓至12樓、15樓至16樓、18樓至23樓、25樓至33樓、35樓至39樓、41樓至43樓、45樓至53樓及55樓至61樓A、B及D單位之煤氣熱水爐及煤氣煮食爐。 - 煤氣喉接駁至第5座 (5B)，7樓至12樓、15樓至16樓、18樓至23樓、25樓至33樓、35樓至39樓、41樓至43樓、45樓至53樓及55樓至61樓A、B、C及D單位之煤氣熱水爐及煤氣煮食爐。 - 煤氣喉接駁至第5座 (5A)，62樓A、B及D單位之煤氣熱水爐及煤氣煮食爐。 - 煤氣喉接駁至第5座 (5B)，62樓A、C及D單位之煤氣熱水爐及煤氣煮食爐。 - 煤氣喉接駁至第6座 (6A)，7樓至12樓、15樓至16樓、18樓至23樓、25樓至33樓、35樓至39樓、41樓至43樓、45樓至53樓及55樓至61樓A及B單位之煤氣熱水爐及煤氣煮食爐。 - 煤氣喉接駁至第6座 (6A)，7樓至12樓、15樓至16樓、18樓至23樓、25樓至33樓、35樓至39樓、41樓至43樓、45樓至53樓及55樓至61樓E單位之煤氣熱水爐。 - 煤氣喉接駁至第6座 (6B)，7樓至12樓、15樓至16樓、18樓至23樓、25樓至33樓、35樓至39樓、41樓至43樓、45樓至53樓及55樓至61樓A及C單位之煤氣熱水爐及煤氣煮食爐。 - 煤氣喉接駁至第6座 (6B)，7樓至12樓、15樓至16樓、18樓至23樓、25樓至33樓、35樓至39樓、41樓至43樓、45樓至53樓及55樓至61樓F單位之煤氣熱水爐。 - 煤氣喉接駁至第6座 (6A)，62樓A單位之煤氣熱水爐及煤氣煮食爐。

Fittings, finishes and appliances

裝置、裝修物料及設備

3. Interior Fittings	
Item	Description
(h) Gas supply	<ul style="list-style-type: none"> - Town gas supply pipes are connected to gas water heater for Flat E, 62/F, Tower 6 (6A). - Town gas supply pipes are connected to gas water heater and gas cooker hob for Flats A & C, 62/F, Tower 6 (6B). - Town gas supply pipes are connected to gas water heater for Flat F, 62/F, Tower 6 (6B). - Town gas supply pipes are connected to gas water heater and gas cooker hob for Flats A & B, 7/F to 12/F, 15/F to 16/F, 18/F to 23/F, 25/F to 33/F, 35/F to 39/F, 41/F to 43/F, 45/F to 53/F & 55/F to 61/F, Tower 7 (7A). - Town gas supply pipes are connected to gas water heater for Flats C, 7/F to 12/F, 15/F to 16/F, 18/F to 23/F, 25/F to 33/F, 35/F to 39/F, 41/F to 43/F, 45/F to 53/F & 55/F to 61/F, Tower 7 (7A). - Town gas supply pipes are connected to gas water heater and gas cooker hob for Flats A,B,D & E, 7/F to 12/F, 15/F to 16/F, 18/F to 23/F, 25/F to 33/F, 35/F to 39/F, 41/F to 43/F, 45/F to 53/F & 55/F to 61/F, Tower 7 (7B). - Town gas supply pipes are connected to gas water heater and gas cooker hob for Flat A, 62/F, Tower 7 (7A). - Town gas supply pipes are connected to gas water heater for Flat C, 62/F, Tower 7 (7A). - Town gas supply pipes are connected to gas water heater and gas cooker hob for Flats A,B & D, 62/F, Tower 7 (7B). - Separate town gas meter is provided in the kitchen of Flats A, B & D, 7/F to 12/F, 15/F to 16/F, 18/F to 23/F, 25/F to 33/F, 35/F to 39/F, 41/F to 43/F, 45/F to 53/F & 55/F to 61/F, Tower 5 (5A). - Separate town gas meter is provided in the kitchen of Flats A, B, C & D, 7/F to 12/F, 15/F to 16/F, 18/F to 23/F, 25/F to 33/F, 35/F to 39/F, 41/F to 43/F, 45/F to 53/F & 55/F to 61/F, Tower 5 (5B). - Separate town gas meter is provided in the kitchen of Flats A, B & D, 62/F, Tower 5 (5A). - Separate town gas meter is provided in the toilet of Flat A, 62/F, Tower 5 (5B). - Separate town gas meter is provided in the kitchen of Flats C & D, 62/F, Tower 5 (5B). - Separate town gas meter is provided in the kitchen of Flats A & B, 7/F to 12/F, 15/F to 16/F, 18/F to 23/F, 25/F to 33/F, 35/F to 39/F, 41/F to 43/F, 45/F to 53/F & 55/F to 61/F, Tower 6 (6A). - Separate town gas meter is provided in the bathroom of Flats E, 7/F to 12/F, 15/F to 16/F, 18/F to 23/F, 25/F to 33/F, 35/F to 39/F, 41/F to 43/F, 45/F to 53/F & 55/F to 61/F, Tower 6 (6A). - Separate town gas meter is provided in the kitchen of Flats A & C, 7/F to 12/F, 15/F to 16/F, 18/F to 23/F, 25/F to 33/F, 35/F to 39/F, 41/F to 43/F, 45/F to 53/F & 55/F to 61/F, Tower 6 (6B). - Separate town gas meter is provided in the bathroom of Flats F, 7/F to 12/F, 15/F to 16/F, 18/F to 23/F, 25/F to 33/F, 35/F to 39/F, 41/F to 43/F, 45/F to 53/F & 55/F to 61/F, Tower 6 (6B).

3. 室內裝置	
細項	描述
(h) 氣體供應	<ul style="list-style-type: none"> - 煤氣喉接駁至第6座 (6A)，62樓E單位之煤氣熱水爐。 - 煤氣喉接駁至第6座 (6B)，62樓A及C單位之煤氣熱水爐及煤氣煮食爐。 - 煤氣喉接駁至第6座 (6B)，62樓F單位之煤氣熱水爐。 - 煤氣喉接駁至第7座 (7A)，7樓至12樓、15樓至16樓、18樓至23樓、25樓至33樓、35樓至39樓、41樓至43樓、45樓至53樓及55樓至61樓A及B單位之煤氣熱水爐及煤氣煮食爐。 - 煤氣喉接駁至第7座 (7A)，7樓至12樓、15樓至16樓、18樓至23樓、25樓至33樓、35樓至39樓、41樓至43樓、45樓至53樓及55樓至61樓C單位之煤氣熱水爐。 - 煤氣喉接駁至第7座 (7B)，7樓至12樓、15樓至16樓、18樓至23樓、25樓至33樓、35樓至39樓、41樓至43樓、45樓至53樓及55樓至61樓A、B、D及E單位之煤氣熱水爐及煤氣煮食爐。 - 煤氣喉接駁至第7座 (7A)，62樓A單位之煤氣熱水爐及煤氣煮食爐。 - 煤氣喉接駁至第7座 (7A)，62樓C單位之煤氣熱水爐。 - 煤氣喉接駁至第7座 (7B)，62樓A、B及D單位之煤氣熱水爐及煤氣煮食爐。 - 第5座 (5A)，7樓至12樓、15樓至16樓、18樓至23樓、25樓至33樓、35樓至39樓、41樓至43樓、45樓至53樓及55樓至61樓A、B及D單位之獨立煤氣錶安裝於廚房內。 - 第5座 (5B)，7樓至12樓、15樓至16樓、18樓至23樓、25樓至33樓、35樓至39樓、41樓至43樓、45樓至53樓及55樓至61樓A、B、C及D單位之獨立煤氣錶安裝於廚房內。 - 第5座 (5A)，62樓A、B及D單位之獨立煤氣錶安裝於廚房內。 - 第5座 (5B)，62樓A單位之獨立煤氣錶安裝於洗手間內。 - 第5座 (5B)，62樓C及D單位之獨立煤氣錶安裝於廚房內。 - 第6座 (6A)，7樓至12樓、15樓至16樓、18樓至23樓、25樓至33樓、35樓至39樓、41樓至43樓、45樓至53樓及55樓至61樓A及B單位之獨立煤氣錶安裝於廚房內。 - 第6座 (6A)，7樓至12樓、15樓至16樓、18樓至23樓、25樓至33樓、35樓至39樓、41樓至43樓、45樓至53樓及55樓至61樓E單位之獨立煤氣錶安裝於浴室內。 - 第6座 (6B)，7樓至12樓、15樓至16樓、18樓至23樓、25樓至33樓、35樓至39樓、41樓至43樓、45樓至53樓及55樓至61樓A及C單位之獨立煤氣錶安裝於廚房內。 - 第6座 (6B)，7樓至12樓、15樓至16樓、18樓至23樓、25樓至33樓、35樓至39樓、41樓至43樓、45樓至53樓及55樓至61樓F單位之獨立煤氣錶安裝於浴室內。

Fittings, finishes and appliances

裝置、裝修物料及設備

3. Interior Fittings	
Item	Description
(h) Gas supply	<ul style="list-style-type: none"> - Separate town gas meter is provided in the kitchen of Flat A, 62/F, Tower 6 (6A). - Separate town gas meter is provided in the bathroom of Flat E, 62/F, Tower 6 (6A). - Separate town gas meter is provided in the kitchen of Flats A & C, 62/F, Tower 6 (6B). - Separate town gas meter is provided in the bathroom of Flat F, 62/F, Tower 6 (6B). - Separate town gas meter is provided in the kitchen of Flats A & B, 7/F to 12/F, 15/F to 16/F, 18/F to 23/F, 25/F to 33/F, 35/F to 39/F, 41/F to 43/F, 45/F to 53/F & 55/F to 61/F, Tower 7 (7A). - Separate town gas meter is provided in the bathroom of Flats C, 7/F to 12/F, 15/F to 16/F, 18/F to 23/F, 25/F to 33/F, 35/F to 39/F, 41/F to 43/F, 45/F to 53/F & 55/F to 61/F, Tower 7 (7A). - Separate town gas meter is provided in the kitchen of Flats A, B, D & E, 7/F to 12/F, 15/F to 16/F, 18/F to 23/F, 25/F to 33/F, 35/F to 39/F, 41/F to 43/F, 45/F to 53/F & 55/F to 61/F, Tower 7 (7B). - Separate town gas meter is provided in the toilet of Flat A, 62/F, Tower 7 (7A). - Separate town gas meter is provided in the bathroom of Flat C, 62/F, Tower 7 (7A). - Separate town gas meter is provided in the kitchen of Flats A, B & D, 62/F, Tower 7 (7B). - No town gas supply is provided for the residential properties other than the above. <p>(13/F, 14/F, 24/F, 34/F, 44/F & 54/F of Tower 5 (5A & 5B) are omitted.) (13/F, 14/F, 24/F, 34/F, 44/F & 54/F of Tower 6 (6A & 6B) are omitted.) (13/F, 14/F, 24/F, 34/F, 44/F & 54/F of Tower 7 (7A & 7B) are omitted.)</p>
(i) Washing machine connection point	<ul style="list-style-type: none"> - Water point and drain point are provided for washing machine. Water supply point of a design of 22mm diameter and drainage point of a design of 40mm diameter. - For location of connection points, please refer to the "Schedule of Mechanical & Electrical Provisions of Residential Properties".
(j) Water supply	<ul style="list-style-type: none"> - Copper pipes are used for cold and hot water supply system. Hot water is available. - uPVC pipes are used for flushing water supply system. - Water pipes are partly concealed and partly exposed*. <p>* Remark: Other than those parts of the water pipes concealed within concrete, the rest of them are exposed. Some of the exposed water pipes are covered or hidden by false ceilings, bulkheads, cabinets, claddings, non-concrete walls, pipe ducts or other materials and are not readily visible.</p>

3. 室內裝置	
細項	描述
(h) 氣體供應	<ul style="list-style-type: none"> - 第6座 (6A), 62樓A單位之獨立煤氣錶安裝於廚房內。 - 第6座 (6A), 62樓E單位之獨立煤氣錶安裝於浴室內。 - 第6座 (6B), 62樓A及C單位之獨立煤氣錶安裝於廚房內。 - 第6座 (6B), 62樓F單位之獨立煤氣錶安裝於浴室內。 - 第7座 (7A), 7樓至12樓、15樓至16樓、18樓至23樓、25樓至33樓、35樓至39樓、41樓至43樓、45樓至53樓及55樓至61樓A及B單位之獨立煤氣錶安裝於廚房內。 - 第7座 (7A), 7樓至12樓、15樓至16樓、18樓至23樓、25樓至33樓、35樓至39樓、41樓至43樓、45樓至53樓及55樓至61樓C單位之獨立煤氣錶安裝於浴室內。 - 第7座 (7B), 7樓至12樓、15樓至16樓、18樓至23樓、25樓至33樓、35樓至39樓、41樓至43樓、45樓至53樓及55樓至61樓A、B、D及E單位之獨立煤氣錶安裝於廚房內。 - 第7座 (7A), 62樓A單位之獨立煤氣錶安裝於洗手間內。 - 第7座 (7A), 62樓C單位之獨立煤氣錶安裝於浴室內。 - 第7座 (7B), 62樓A、B及D單位之獨立煤氣錶安裝於廚房內。 - 除上述外其他住宅物業不提供氣體供應。 <p>(第5座 (5A及5B)不設13樓、14樓、24樓、34樓、44樓及54樓。) (第6座 (6A及6B)不設13樓、14樓、24樓、34樓、44樓及54樓。) (第7座 (7A及7B)不設13樓、14樓、24樓、34樓、44樓及54樓。)</p>
(i) 洗衣機接駁點	<ul style="list-style-type: none"> - 洗衣機設有來水及去水接駁點。設計直徑為22毫米來水接駁喉位及設計直徑為40毫米去水接駁喉位。 - 有關接駁點的位置，請參考「住宅物業機電裝置數量說明表」。
(j) 供水	<ul style="list-style-type: none"> - 冷熱水供水系統採用銅喉管。有熱水供應。 - 沖廁供水系統採用膠喉管。 - 水管是部分隱藏及部分外露*。 <p>* 備註：除部分隱藏於混凝土內之水管外，其他部分的水管均為外露。部分外露的水管以假天花、裝飾橫樑、櫃、覆蓋板、非混凝土牆、管道槽或其他物料覆蓋或掩藏，並不容易看見。</p>

Fittings, finishes and appliances

裝置、裝修物料及設備

4. Miscellaneous	
Item	Description
(a) Lifts	<p>Residential Tower Lifts</p> <p>Tower 5</p> <ul style="list-style-type: none"> - 6 nos. of "Schindler" (model no.: Schindler 7000) passenger lifts serve 6/F to 12/F, 15/F to 16/F, 18/F to 23/F, 25/F to 33/F, 35/F to 39/F, 41/F to 43/F, 45/F to 53/F & 55/F to 62/F. - 1 no. of "Schindler" (model no.: Schindler 7000) service lift serves 6/F to 12/F, 15/F to 23/F, 25/F to 33/F, 35/F to 43/F, 45/F to 53/F & 55/F to 62/F. <p>Tower 6</p> <ul style="list-style-type: none"> - 6 nos. of "Schindler" (model no.: Schindler 7000) passenger lifts serve 6/F to 12/F, 15/F to 16/F, 18/F to 23/F, 25/F to 33/F, 35/F to 39/F, 41/F to 43/F, 45/F to 53/F & 55/F to 62/F. - 1 no. of "Schindler" (model no.: Schindler 7000) service lift serves 6/F to 12/F, 15/F to 23/F, 25/F to 33/F, 35/F to 43/F, 45/F to 53/F & 55/F to 62/F. <p>Tower 7</p> <ul style="list-style-type: none"> - 6 nos. of "Schindler" (model no.: Schindler 7000) passenger lifts serve 6/F to 12/F, 15/F to 16/F, 18/F to 23/F, 25/F to 33/F, 35/F to 39/F, 41/F to 43/F, 45/F to 53/F & 55/F to 62/F. - 1 no. of "Schindler" (model no.: Schindler 7000) service lift serves 6/F to 12/F, 15/F to 23/F, 25/F to 33/F, 35/F to 43/F, 45/F to 53/F & 55/F to 62/F. <p>Podium Clubhouse Lifts</p> <ul style="list-style-type: none"> - 1 no. of "Schindler" (model no.: Schindler 5500) clubhouse lift serves 5/F *, 5M/F & 6/F *. <p>*Note : 5/F and 6/F will complete in other Phase of the development</p> <p>(13/F, 14/F, 24/F, 34/F, 44/F & 54/F of Tower 5 (5A & 5B) are omitted.) (13/F, 14/F, 24/F, 34/F, 44/F & 54/F of Tower 6 (6A & 6B) are omitted.) (13/F, 14/F, 24/F, 34/F, 44/F & 54/F of Tower 7 (7A & 7B) are omitted.)</p>
(b) Letter box	Metal letter box is provided.
(c) Refuse collection	Refuse storage and material recovery room is provided for storage of refuse at the common area of each residential floor. The refuse is collected and transported by cleaners to the central refuse storage and material recovery chamber provided on G/F for removal.

The vendor undertakes that if lifts or appliances of the specified brand name or model number are not installed in the Phase, lifts or appliances of comparable quality will be installed.

4. 雜項	
細項	描述
(a) 升降機	<p>住宅大廈升降機</p> <p>第5座</p> <ul style="list-style-type: none"> - 設有6部「迅達」客用升降機 (產品型號：迅達7000) 直達6樓至12樓、15樓至16樓、18樓至23樓、25樓至33樓、35樓至39樓、41樓至43樓、45樓至53樓及55樓至62樓。 - 設有1部「迅達」服務升降機 (產品型號：迅達7000) 直達6樓至12樓、15樓至23樓、25樓至33樓、35樓至43樓、45樓至53樓及55樓至62樓。 <p>第6座</p> <ul style="list-style-type: none"> - 設有6部「迅達」客用升降機 (產品型號：迅達7000) 直達6樓至12樓、15樓至16樓、18樓至23樓、25樓至33樓、35樓至39樓、41樓至43樓、45樓至53樓及55樓至62樓。 - 設有1部「迅達」服務升降機 (產品型號：迅達7000) 直達6樓至12樓、15樓至23樓、25樓至33樓、35樓至43樓、45樓至53樓及55樓至62樓。 <p>第7座</p> <ul style="list-style-type: none"> - 設有6部「迅達」客用升降機 (產品型號：迅達7000) 直達6樓至12樓、15樓至16樓、18樓至23樓、25樓至33樓、35樓至39樓、41樓至43樓、45樓至53樓及55樓至62樓。 - 設有1部「迅達」服務升降機 (產品型號：迅達7000) 直達6樓至12樓、15樓至23樓、25樓至33樓、35樓至43樓、45樓至53樓及55樓至62樓。 <p>平台會所升降機</p> <ul style="list-style-type: none"> - 設有1部「迅達」會所升降機 (產品型號：迅達5500) 直達5樓*、5M樓及6樓*。 <p>*註釋：5樓及6樓會於發展項目的其他期數完成。</p> <p>(第5座 (5A及5B)不設13樓、14樓、24樓、34樓、44樓及54樓。) (第6座 (6A及6B)不設13樓、14樓、24樓、34樓、44樓及54樓。) (第7座 (7A及7B)不設13樓、14樓、24樓、34樓、44樓及54樓。)</p>
(b) 信箱	設置金屬信箱。
(c) 垃圾收集	每層住宅樓層的公用地方設有垃圾及物料回收室，貯存垃圾，並由清潔工人收集及運送到地下之垃圾及物料回收房，處理及運走。

賣方承諾如期數中沒有安裝指明的品牌名稱或產品型號的升降機或設備，便會安裝品質相若的升降機或設備。

Fittings, finishes and appliances

裝置、裝修物料及設備

4. Miscellaneous	
Item	Description
(d) Water meter, electricity meter and gas meter	<p>Water meter</p> <ul style="list-style-type: none"> - Separate water meter for individual residential property is provided in the water meter cabinet on each residential floor. <p>Electricity meter</p> <ul style="list-style-type: none"> - Separate electricity meter for individual residential property is provided in the electricity meter room on each residential floor. <p>Town gas meter</p> <ul style="list-style-type: none"> - Separate town gas meter is provided in the kitchen of Flats A, B & D, 7/F to 12/F, 15/F to 16/F, 18/F to 23/F, 25/F to 33/F, 35/F to 39/F, 41/F to 43/F, 45/F to 53/F & 55/F to 61/F, Tower 5 (5A). - Separate town gas meter is provided in the kitchen of Flats A, B, C & D, 7/F to 12/F, 15/F to 16/F, 18/F to 23/F, 25/F to 33/F, 35/F to 39/F, 41/F to 43/F, 45/F to 53/F & 55/F to 61/F, Tower 5 (5B). - Separate town gas meter is provided in the kitchen of Flats A, B & D, 62/F, Tower 5 (5A). - Separate town gas meter is provided in the toilet of Flat A, 62/F, Tower 5 (5B). - Separate town gas meter is provided in the kitchen of Flats C & D, 62/F, Tower 5 (5B). - Separate town gas meter is provided in the kitchen of Flats A & B, 7/F to 12/F, 15/F to 16/F, 18/F to 23/F, 25/F to 33/F, 35/F to 39/F, 41/F to 43/F, 45/F to 53/F & 55/F to 61/F, Tower 6 (6A). - Separate town gas meter is provided in the bathroom of Flats E, 7/F to 12/F, 15/F to 16/F, 18/F to 23/F, 25/F to 33/F, 35/F to 39/F, 41/F to 43/F, 45/F to 53/F & 55/F to 61/F, Tower 6 (6A). - Separate town gas meter is provided in the kitchen of Flats A & C, 7/F to 12/F, 15/F to 16/F, 18/F to 23/F, 25/F to 33/F, 35/F to 39/F, 41/F to 43/F, 45/F to 53/F & 55/F to 61/F, Tower 6 (6B). - Separate town gas meter is provided in the bathroom of Flats F, 7/F to 12/F, 15/F to 16/F, 18/F to 23/F, 25/F to 33/F, 35/F to 39/F, 41/F to 43/F, 45/F to 53/F & 55/F to 61/F, Tower 6 (6B). - Separate town gas meter is provided in the kitchen of Flat A, 62/F, Tower 6 (6A). - Separate town gas meter is provided in the bathroom of Flat E, 62/F, Tower 6 (6A). - Separate town gas meter is provided in the kitchen of Flats A & C, 62/F, Tower 6 (6B). - Separate town gas meter is provided in the bathroom of Flat F, 62/F, Tower 6 (6B).

4. 雜項	
細項	描述
(d) 水錶、電錶及氣體錶	<p>水錶</p> <ul style="list-style-type: none"> - 每戶住宅物業之獨立水錶安裝於大廈每層住宅樓層之水錶箱內。 <p>電錶</p> <ul style="list-style-type: none"> - 每戶住宅物業之獨立電錶安裝於大廈每層住宅樓層之電錶房內。 <p>氣體錶</p> <ul style="list-style-type: none"> - 第5座 (5A), 7樓至12樓、15樓至16樓、18樓至23樓、25樓至33樓、35樓至39樓、41樓至43樓、45樓至53樓及55樓至61樓A、B及D單位之獨立煤氣錶安裝於廚房內。 - 第5座 (5B), 7樓至12樓、15樓至16樓、18樓至23樓、25樓至33樓、35樓至39樓、41樓至43樓、45樓至53樓及55樓至61樓A、B、C及D單位之獨立煤氣錶安裝於廚房內。 - 第5座 (5A), 62樓A、B及D單位之獨立煤氣錶安裝於廚房內。 - 第5座 (5B), 62樓A單位之獨立煤氣錶安裝於洗手間內。 - 第5座 (5B), 62樓C及D單位之獨立煤氣錶安裝於廚房內。 - 第6座 (6A), 7樓至12樓、15樓至16樓、18樓至23樓、25樓至33樓、35樓至39樓、41樓至43樓、45樓至53樓及55樓至61樓A及B單位之獨立煤氣錶安裝於廚房內。 - 第6座 (6A), 7樓至12樓、15樓至16樓、18樓至23樓、25樓至33樓、35樓至39樓、41樓至43樓、45樓至53樓及55樓至61樓E單位之獨立煤氣錶安裝於浴室內。 - 第6座 (6B), 7樓至12樓、15樓至16樓、18樓至23樓、25樓至33樓、35樓至39樓、41樓至43樓、45樓至53樓及55樓至61樓A及C單位之獨立煤氣錶安裝於廚房內。 - 第6座 (6B), 7樓至12樓、15樓至16樓、18樓至23樓、25樓至33樓、35樓至39樓、41樓至43樓、45樓至53樓及55樓至61樓F單位之獨立煤氣錶安裝於浴室內。 - 第6座 (6A), 62樓A單位之獨立煤氣錶安裝於廚房內。 - 第6座 (6A), 62樓E單位之獨立煤氣錶安裝於浴室內。 - 第6座 (6B), 62樓A及C單位之獨立煤氣錶安裝於廚房內。 - 第6座 (6B), 62樓F單位之獨立煤氣錶安裝於浴室內。

Fittings, finishes and appliances

裝置、裝修物料及設備

4. Miscellaneous	
Item	Description
(d) Water meter, electricity meter and gas meter	<p>Town gas meter</p> <ul style="list-style-type: none"> - Separate town gas meter is provided in the kitchen of Flats A & B, 7/F to 12/F, 15/F to 16/F, 18/F to 23/F, 25/F to 33/F, 35/F to 39/F, 41/F to 43/F, 45/F to 53/F & 55/F to 61/F, Tower 7 (7A). - Separate town gas meter is provided in the bathroom of Flats C, 7/F to 12/F, 15/F to 16/F, 18/F to 23/F, 25/F to 33/F, 35/F to 39/F, 41/F to 43/F, 45/F to 53/F & 55/F to 61/F, Tower 7 (7A). - Separate town gas meter is provided in the kitchen of Flats A, B, D & E, 7/F to 12/F, 15/F to 16/F, 18/F to 23/F, 25/F to 33/F, 35/F to 39/F, 41/F to 43/F, 45/F to 53/F & 55/F to 61/F, Tower 7 (7B). - Separate town gas meter is provided in the toilet of Flat A, 62/F, Tower 7 (7A). - Separate town gas meter is provided in the bathroom of Flat C, 62/F, Tower 7 (7A). - Separate town gas meter is provided in the kitchen of Flats A, B & D, 62/F, Tower 7 (7B). <p>No town gas supply is provided for the residential properties other than the above.</p> <p>(13/F, 14/F, 24/F, 34/F, 44/F & 54/F of Tower 5 (5A & 5B) are omitted.) (13/F, 14/F, 24/F, 34/F, 44/F & 54/F of Tower 6 (6A & 6B) are omitted.) (13/F, 14/F, 24/F, 34/F, 44/F & 54/F of Tower 7 (7A & 7B) are omitted.)</p>

5. Security Facilities	
Description	
<ul style="list-style-type: none"> - CCTV cameras are provided at entrance lobby, lift cars, refuge floor and roof. Visitor intercom panel is provided at entrance lobby, with intercom connected to caretaker's counter at 6/F entrance lobby. Smart card readers are provided at entrance lobby, lift cars and roof. - Each residential property is equipped with a handfree type door phone, connected to caretaker's counter at entrance lobby. - Intercom with CCTV cameras are equipped at temporary refuge space of each residential floor, connected to 5/F estate management office. 	

6. Appliances	
Description	
<ul style="list-style-type: none"> - As set out in the "Appliances Schedule". 	

The vendor undertakes that if lifts or appliances of the specified brand name or model number are not installed in the Phase, lifts or appliances of comparable quality will be installed.

4. 雜項	
細項	描述
(d) 水錶、電錶及氣體錶	<p>氣體錶</p> <ul style="list-style-type: none"> - 第7座 (7A), 7樓至12樓、15樓至16樓、18樓至23樓、25樓至33樓、35樓至39樓、41樓至43樓、45樓至53樓及55樓至61樓A及B單位之獨立煤氣錶安裝於廚房內。 - 第7座 (7A), 7樓至12樓、15樓至16樓、18樓至23樓、25樓至33樓、35樓至39樓、41樓至43樓、45樓至53樓及55樓至61樓C單位之獨立煤氣錶安裝於浴室內。 - 第7座 (7B), 7樓至12樓、15樓至16樓、18樓至23樓、25樓至33樓、35樓至39樓、41樓至43樓、45樓至53樓及55樓至61樓A、B、D及E單位之獨立煤氣錶安裝於廚房內。 - 第7座 (7A), 62樓A單位之獨立煤氣錶安裝於洗手間內。 - 第7座 (7A), 62樓C單位之獨立煤氣錶安裝於浴室內。 - 第7座 (7B), 62樓A、B及D單位之獨立煤氣錶安裝於廚房內。 <p>除上述外其他住宅物業不提供氣體供應。</p> <p>(第5座 (5A及5B)不設13樓、14樓、24樓、34樓、44樓及54樓。) (第6座 (6A及6B)不設13樓、14樓、24樓、34樓、44樓及54樓。) (第7座 (7A及7B)不設13樓、14樓、24樓、34樓、44樓及54樓。)</p>

5. 保安設施	
描述	
<ul style="list-style-type: none"> - 入口大堂、大廈升降機、庇護層及天台均裝設有閉路電視，入口大堂設有對講機，對講機接駁至6樓入口大堂接待處。入口大堂、大廈升降機及天台均設有智能讀卡器。 - 每個住宅物業均裝設有免提式對講機，接駁至入口大堂接待處。 - 每層住宅樓層臨時庇護處均裝設有對講機及閉路電視，接駁至5樓屋苑管理辦公室。 	

6. 設備	
描述	
<ul style="list-style-type: none"> - 於「設備說明表」列出。 	

賣方承諾如期數中沒有安裝指明的品牌名稱或產品型號的升降機或設備，便會安裝品質相若的升降機或設備。

Fittings, finishes and appliances

裝置、裝修物料及設備

Schedule of Mechanical & Electrical Provisions of Residential Properties 住宅物業機電裝置數量說明表

Location 位置	Description 描述	Tower 5 (5A) 第5座 (5A)															Tower 5 (5B) 第5座 (5B)											
		7/F 7樓					8/F-12/F, 15/F-16/F, 18/F-23/F, 25/F-33/F, 35/F-39/F, 41/F-43/F, 45/F-53/F & 55/F-61/F 8樓至12樓, 15樓至16樓, 18樓至23樓, 25樓至33樓, 35樓至39樓, 41樓至43樓, 45樓至53樓及55樓至61樓					62/F 62樓					7/F 7樓				8/F-12/F, 15/F-16/F, 18/F-23/F, 25/F-33/F, 35/F-39/F, 41/F-43/F, 45/F-53/F & 55/F-61/F 8樓至12樓, 15樓至16樓, 18樓至23樓, 25樓至33樓, 35樓至39樓, 41樓至43樓, 45樓至53樓及55樓至61樓					62/F 62樓		
		A	B	C	D	E	A	B	C	D	E	A	B	D	E	A	B	C	D	A	B	C	D	A	C	D		
Flat Entrance 單位入口	Door Bell Push Button 門鈴按鈕	1	1	1	1	1	1	1	1	1	1	1	1	1	1	1	1	1	1	1	1	1	1	1	1	1		
Living Room / Dining Room / Corridor 客廳 / 飯廳 / 走廊	Master Lighting Switch 燈掣總開關	1	1	1	1	1	1	1	1	1	1	1	1	1	1	1	1	1	1	1	1	1	1	1	1	1		
	Lighting Switch 燈掣	12	11	8	11	9	12	11	8	11	9	15	11	11	9	10	10	11	11	10	10	11	11	13	11	11		
	Lighting Point 燈位	5	5	4	4	3	5	5	4	4	3	6	5	4	3	4	4	4	5	4	4	4	5	11	4	5		
	Switch for Exhaust Fan 抽氣扇開關	2	2	1	2	1	2	2	1	2	1	2	2	2	1	2	2	2	2	2	2	2	2	2	2	2		
	Switch for Electric Water Heater 電熱水爐開關	-	-	1	-	1	-	-	1	-	1	-	-	-	1	-	-	-	-	-	-	-	-	-	-	-		
	Video Door Phone 視像對講機	1	1	1	1	1	1	1	1	1	1	1	1	1	1	1	1	1	1	1	1	1	1	1	1	1		
	13A Twin Socket Outlet 13A雙位電插座	4	4	4	4	4	4	4	4	4	4	6	4	4	4	4	4	4	4	4	4	4	4	6	4	4		
	13A Single Socket Outlet with USB Outlet 13A單位電插座配USB插座	-	-	-	-	-	-	-	-	-	-	1	-	-	-	-	-	-	-	-	-	-	-	1	-	-		
	13A Twin Socket Outlet with USB Outlet 13A雙位電插座配USB插座	-	-	-	-	-	-	-	-	-	-	1	-	-	-	-	-	-	-	-	-	-	-	1	-	-		
	Connection Point for Lighting 燈位接線位	-	-	-	-	-	-	-	-	-	-	2	-	-	-	-	-	-	-	-	-	-	-	2	-	-		
	Connection Point for Built-in Fridge-freezer 嵌入式雪櫃連冰箱接線位	-	-	-	-	-	-	-	-	-	-	1	-	-	-	-	-	-	-	-	-	-	-	1	-	-		
	Connection Point for Mastercool Wine Conditioning Unit Mastercool 酒櫃接線位	-	-	-	-	-	-	-	-	-	-	1	-	-	-	-	-	-	-	-	-	-	-	1	-	-		
	Connection Point for Coffee Machine 咖啡機接線位	-	-	-	-	-	-	-	-	-	-	1	-	-	-	-	-	-	-	-	-	-	-	1	-	-		
	Connection Point for Gourmet Warming Drawer 食物保溫櫃接線位	-	-	-	-	-	-	-	-	-	-	1	-	-	-	-	-	-	-	-	-	-	-	1	-	-		
TV/FM Outlet 電視/電台插座	2	2	2	2	2	2	2	2	2	2	2	2	2	2	2	2	2	2	2	2	2	2	2	2	2			
Telephone Outlet 電話插座	2	2	2	2	2	2	2	2	2	2	2	2	2	2	2	2	2	2	2	2	2	2	2	2	2			
Connection point for Indoor Air-Conditioner Unit 室內空調機接線位	1	1	1	1	1	1	1	1	1	1	2	1	1	1	1	1	1	1	1	1	1	1	2	1	1			
Master Bedroom 主人睡房	Lighting Switch 燈掣	4	4	2	1	2	4	4	2	2	2	3	4	2	2	4	4	2	1	4	4	2	2	4	2	2		
	Lighting Point 燈位	2	1	1	1	1	2	1	1	1	1	2	1	1	1	2	2	1	1	2	2	1	1	3	1	1		
	Switch for Exhaust Fan 抽氣扇開關	1	1	-	-	-	1	1	-	-	-	1	1	-	-	1	1	-	-	1	1	-	-	1	-	-		
	13A Single Socket Outlet 13A單位電插座	-	-	-	-	-	-	-	-	-	-	1	-	-	-	-	-	-	-	-	-	-	-	1	-	-		
	13A Twin Socket Outlet 13A雙位電插座	2	2	2	2	2	2	2	2	2	2	3	2	2	2	2	2	2	2	2	2	2	2	3	2	2		
	TV/FM Outlet 電視/電台插座	1	1	1	1	1	1	1	1	1	1	2	1	1	1	1	1	1	1	1	1	1	1	2	1	1		
	Telephone Outlet 電話插座	1	1	1	1	1	1	1	1	1	1	2	1	1	1	1	1	1	1	1	1	1	1	2	1	1		
Connection point for Indoor Air-Conditioner Unit 室內空調機接線位	1	1	1	1	1	1	1	1	1	1	1	1	1	1	1	1	1	1	1	1	1	1	1	1	1			

Remarks :

- “1, 2,” denotes the quantity of such provision(s) provided in the residential property.
- “-” denotes “not applicable”.
- The quantity of the lighting switch shown in the schedule denotes the quantity of switch on/off button(s).
- 13/F, 14/F, 24/F, 34/F, 44/F and 54/F are omitted.

備註 :

- “1, 2,” 表示提供於該住宅物業內的裝置數量。
- “-” 代表 “不適用”。
- 說明表所顯示的燈掣數量是表示燈掣開/關的數量。
- 不設13樓、14樓、24樓、34樓、44樓及54樓。

Fittings, finishes and appliances

裝置、裝修物料及設備

Schedule of Mechanical & Electrical Provisions of Residential Properties 住宅物業機電裝置數量說明表

Location 位置	Description 描述	Tower 5 (5A) 第5座 (5A)															Tower 5 (5B) 第5座 (5B)														
		7/F 7樓					8/F-12/F, 15/F-16/F, 18/F-23/F, 25/F-33/F, 35/F-39/F, 41/F-43/F, 45/F-53/F & 55/F-61/F 8樓至12樓, 15樓至16樓, 18樓至23樓, 25樓至33樓, 35樓至39樓, 41樓至43樓, 45樓至53樓及55樓至61樓					62/F 62樓					7/F 7樓					8/F-12/F, 15/F-16/F, 18/F-23/F, 25/F-33/F, 35/F-39/F, 41/F-43/F, 45/F-53/F & 55/F-61/F 8樓至12樓, 15樓至16樓, 18樓至23樓, 25樓至33樓, 35樓至39樓, 41樓至43樓, 45樓至53樓及55樓至61樓					62/F 62樓				
		A	B	C	D	E	A	B	C	D	E	A	B	D	E	A	B	C	D	A	B	C	D	A	C	D					
Bedroom 1 睡房 1	Lighting Switch 燈掣	1	1	1	1	1	1	1	1	1	1	1	1	1	1	1	1	1	1	1	1	1	1	3	1	1					
	Lighting Point 燈位	1	1	1	1	1	1	1	1	1	1	1	1	1	1	1	1	1	1	1	1	1	1	1	1	1					
	Switch for Exhaust Fan 抽氣扇開關	-	-	-	-	-	-	-	-	-	-	-	-	-	-	-	-	-	-	-	-	-	-	1	-	-					
	13A Single Socket Outlet 13A單位電插座	1	1	1	1	1	1	1	1	1	1	1	1	1	1	1	1	1	1	1	1	1	1	1	1	1					
	13A Twin Socket Outlet 13A雙位電插座	1	1	1	1	1	1	1	1	1	1	1	1	1	1	1	1	1	1	1	1	1	1	1	1	1					
	TV/FM Outlet 電視/電台插座	1	1	1	1	1	1	1	1	1	1	1	1	1	1	1	1	1	1	1	1	1	1	1	1	1					
	Telephone Outlet 電話插座	1	1	1	1	1	1	1	1	1	1	1	1	1	1	1	1	1	1	1	1	1	1	1	1	1					
Connection point for Indoor Air-Conditioner Unit 室內空調機接線位	1	1	1	1	1	1	1	1	1	1	1	1	1	1	1	1	1	1	1	1	1	1	1	1	1						
Bedroom 2 睡房 2	Lighting Switch 燈掣	1	-	-	-	-	1	-	-	-	-	1	-	-	-	1	1	-	-	1	1	-	-	1	-	-					
	Lighting Point 燈位	1	-	-	-	-	1	-	-	-	-	1	-	-	-	1	1	-	-	1	1	-	-	1	-	-					
	13A Single Socket Outlet 13A單位電插座	1	-	-	-	-	1	-	-	-	-	1	-	-	-	1	1	-	-	1	1	-	-	1	-	-					
	13A Twin Socket Outlet 13A雙位電插座	1	-	-	-	-	1	-	-	-	-	1	-	-	-	1	1	-	-	1	1	-	-	1	-	-					
	TV/FM Outlet 電視/電台插座	1	-	-	-	-	1	-	-	-	-	1	-	-	-	1	1	-	-	1	1	-	-	1	-	-					
	Telephone Outlet 電話插座	1	-	-	-	-	1	-	-	-	-	1	-	-	-	1	1	-	-	1	1	-	-	1	-	-					
	Connection point for Indoor Air-Conditioner Unit 室內空調機接線位	1	-	-	-	-	1	-	-	-	-	1	-	-	-	1	1	-	-	1	1	-	-	1	-	-					
Bedroom 3 睡房 3	Lighting Switch 燈掣	-	-	-	-	-	-	-	-	-	-	2	-	-	-	-	-	-	-	-	-	-	-	1	-	-					
	Lighting Point 燈位	-	-	-	-	-	-	-	-	-	-	2	-	-	-	-	-	-	-	-	-	-	-	1	-	-					
	13A Single Socket Outlet 13A單位電插座	-	-	-	-	-	-	-	-	-	-	1	-	-	-	-	-	-	-	-	-	-	-	1	-	-					
	13A Twin Socket Outlet 13A雙位電插座	-	-	-	-	-	-	-	-	-	-	1	-	-	-	-	-	-	-	-	-	-	-	1	-	-					
	TV/FM Outlet 電視/電台插座	-	-	-	-	-	-	-	-	-	-	1	-	-	-	-	-	-	-	-	-	-	-	1	-	-					
	Telephone Outlet 電話插座	-	-	-	-	-	-	-	-	-	-	1	-	-	-	-	-	-	-	-	-	-	-	1	-	-					
	Connection point for Indoor Air-Conditioner Unit 室內空調機接線位	-	-	-	-	-	-	-	-	-	-	1	-	-	-	-	-	-	-	-	-	-	-	1	-	-					

Remarks :

- "1, 2," denotes the quantity of such provision(s) provided in the residential property.
- "-" denotes "not applicable".
- The quantity of the lighting switch shown in the schedule denotes the quantity of switch on/off button(s).
- 13/F, 14/F, 24/F, 34/F, 44/F and 54/F are omitted.

備註 :

- "1, 2," 表示提供於該住宅物業內的裝置數量。
- "-" 代表 "不適用"。
- 說明表所顯示的燈掣數量是表示燈掣開/關的數量。
- 不設13樓、14樓、24樓、34樓、44樓及54樓。

Fittings, finishes and appliances

裝置、裝修物料及設備

Schedule of Mechanical & Electrical Provisions of Residential Properties 住宅物業機電裝置數量說明表

Location 位置	Description 描述	Tower 5 (5A) 第5座 (5A)															Tower 5 (5B) 第5座 (5B)											
		7/F 7樓					8/F-12/F, 15/F-16/F, 18/F-23/F, 25/F-33/F, 35/F-39/F, 41/F-43/F, 45/F-53/F & 55/F-61/F 8樓至12樓, 15樓至16樓, 18樓至23樓, 25樓至33樓, 35樓至39樓, 41樓至43樓, 45樓至53樓及55樓至61樓					62/F 62樓					7/F 7樓				8/F-12/F, 15/F-16/F, 18/F-23/F, 25/F-33/F, 35/F-39/F, 41/F-43/F, 45/F-53/F & 55/F-61/F 8樓至12樓, 15樓至16樓, 18樓至23樓, 25樓至33樓, 35樓至39樓, 41樓至43樓, 45樓至53樓及55樓至61樓					62/F 62樓		
		A	B	C	D	E	A	B	C	D	E	A	B	D	E	A	B	C	D	A	B	C	D	A	C	D		
Bathroom 浴室	Lighting Point 燈位	-	-	3	3	3	-	-	3	3	3	-	-	3	3	-	-	3	3	-	-	3	3	-	3	3		
	13A Twin Socket Outlet 13A雙位電插座	-	-	1	1	1	-	-	1	1	1	-	-	1	1	-	-	1	1	-	-	1	1	-	1	1		
	Power Bar 多功能插蘇板	-	-	1	1	1	-	-	1	1	1	-	-	1	1	-	-	1	1	-	-	1	1	-	1	1		
	Wireless charger 無線充電座	-	-	1	1	1	-	-	1	1	1	-	-	1	1	-	-	1	1	-	-	1	1	-	1	1		
	13A Twin Socket Outlet for Built-in Washer Dryer and Other Purpose 13A 雙位電插座供嵌入式洗衣乾衣機及其他用途	-	-	1	1	1	-	-	1	1	1	-	-	1	1	-	-	1	1	-	-	1	1	-	1	1		
	Connection Point for Other Purpose 接線位供其他用途	-	-	1	1	1	-	-	1	1	1	-	-	1	1	-	-	1	1	-	-	1	1	-	1	1		
	Connection Point for Mirror Cabinet Lighting 鏡櫃燈接線位	-	-	1	1	1	-	-	1	1	1	-	-	1	1	-	-	1	1	-	-	1	1	-	1	1		
	Connection Point for Lighting at Flat Roof 接線位供平台燈	-	-	1	-	1	-	-	-	-	-	-	-	-	-	-	-	1	-	-	-	-	-	-	-	-		
	Connection Point for Lighting at Roof 接線位供天台燈	-	-	-	-	-	-	-	-	-	-	-	-	1	1	-	-	-	-	-	-	-	-	-	1	1		
	Connection Point For Exhaust Fan 抽氣扇接線位	-	-	1	1	1	-	-	1	1	1	-	-	1	1	-	-	1	1	-	-	1	1	-	1	1		
	Connection Point for Thermal Ventilator 浴室換氣暖風機接線位	-	-	1	1	1	-	-	1	1	1	-	-	1	1	-	-	1	1	-	-	1	1	-	1	1		
	Gas Water Heater Remote Controller 煤氣熱水爐遙控器	-	-	-	1	-	-	-	-	1	-	-	-	1	-	-	-	1	1	-	-	1	1	-	1	1		
	Connection Point for Electric Water heater 電熱水爐接線位	-	-	1	-	1	-	-	1	-	1	-	-	-	1	-	-	-	-	-	-	-	-	-	-	-		
	Electric Water Heater Temperature Control 電熱水爐溫度控制	-	-	1	-	1	-	-	1	-	1	-	-	-	1	-	-	-	-	-	-	-	-	-	-	-		
Built-in Washer Dryer Connection Point (Water Inlet) 嵌入式洗衣乾衣機接駁點 (來水位)	-	-	1	1	1	-	-	1	1	1	-	-	1	1	-	-	1	1	-	-	1	1	-	1	1			
Built-in Washer Dryer Connection Point (Water Outlet) 嵌入式洗衣乾衣機接駁點 (去水位)	-	-	1	1	1	-	-	1	1	1	-	-	1	1	-	-	1	1	-	-	1	1	-	1	1			
Bathroom 1 浴室 1	Lighting Point 燈位	3	3	-	-	-	3	3	-	-	-	5	3	-	-	3	3	-	-	3	3	-	-	5	-	-		
	13A Twin Socket Outlet 13A雙位電插座	1	1	-	-	-	1	1	-	-	-	2	1	-	-	1	1	-	-	1	1	-	-	2	-	-		
	Power Bar 多功能插蘇板	1	1	-	-	-	1	1	-	-	-	1	1	-	-	1	1	-	-	1	1	-	-	1	-	-		
	Wireless charger 無線充電座	1	1	-	-	-	1	1	-	-	-	1	1	-	-	1	1	-	-	1	1	-	-	1	-	-		
	Connection Point for Other Purpose 接線位供其他用途	1	1	-	-	-	1	1	-	-	-	1	1	-	-	1	1	-	-	1	1	-	-	1	-	-		
	Connection Point for Mirror Cabinet Lighting 鏡櫃燈接線位	1	1	-	-	-	1	1	-	-	-	1	1	-	-	1	1	-	-	1	1	-	-	1	-	-		
	Connection Point for Lighting at Flat Roof 接線位供平台燈	1	1	-	-	-	-	-	-	-	-	-	-	-	-	1	1	-	-	-	-	-	-	-	-	-		
	Connection Point for Lighting at Roof 接線位供天台燈	-	-	-	-	-	-	-	-	-	-	1	1	-	-	-	-	-	-	-	-	-	-	1	-	-		
	Connection Point For Exhaust Fan 抽氣扇接線位	1	1	-	-	-	1	1	-	-	-	1	1	-	-	1	1	-	-	1	1	-	-	1	-	-		
	Connection Point for Thermal Ventilator 浴室換氣暖風機接線位	1	1	-	-	-	1	1	-	-	-	1	1	-	-	1	1	-	-	1	1	-	-	1	-	-		
Gas Water Heater Remote Controller 煤氣熱水爐遙控器	1	1	-	-	-	1	1	-	-	-	1	1	-	-	1	1	-	-	1	1	-	-	1	-	-			

Remarks :

- “1, 2,” denotes the quantity of such provision(s) provided in the residential property.
- “-” denotes “not applicable”.
- The quantity of the lighting switch shown in the schedule denotes the quantity of switch on/off button(s).
- 13/F, 14/F, 24/F, 34/F, 44/F and 54/F are omitted.

備註 :

- “1, 2,” 表示提供於該住宅物業內的裝置數量。
- “-” 代表 “不適用”。
- 說明表所顯示的燈掣數量是表示燈掣開/關的數量。
- 不設13樓、14樓、24樓、34樓、44樓及54樓。

Fittings, finishes and appliances

裝置、裝修物料及設備

Schedule of Mechanical & Electrical Provisions of Residential Properties 住宅物業機電裝置數量說明表

Location 位置	Description 描述	Tower 5 (5A) 第5座 (5A)															Tower 5 (5B) 第5座 (5B)											
		7/F 7樓					8/F-12/F, 15/F-16/F, 18/F-23/F, 25/F-33/F, 35/F-39/F, 41/F-43/F, 45/F-53/F & 55/F-61/F 8樓至12樓, 15樓至16樓, 18樓至23樓, 25樓至33樓, 35樓至39樓, 41樓至43樓, 45樓至53樓及55樓至61樓					62/F 62樓					7/F 7樓				8/F-12/F, 15/F-16/F, 18/F-23/F, 25/F-33/F, 35/F-39/F, 41/F-43/F, 45/F-53/F & 55/F-61/F 8樓至12樓, 15樓至16樓, 18樓至23樓, 25樓至33樓, 35樓至39樓, 41樓至43樓, 45樓至53樓及55樓至61樓					62/F 62樓		
		A	B	C	D	E	A	B	C	D	E	A	B	D	E	A	B	C	D	A	B	C	D	A	C	D		
Bathroom 2 浴室 2	Lighting Point 燈位	3	3	-	-	-	3	3	-	-	-	3	3	-	-	-	3	3	-	-	3	3	-	-	3	-	-	
	13A Twin Socket Outlet 13A雙位電插座	1	1	-	-	-	1	1	-	-	-	1	1	-	-	-	1	1	-	-	1	1	-	-	1	-	-	
	Power Bar 多功能插蘇板	1	1	-	-	-	1	1	-	-	-	1	1	-	-	-	1	1	-	-	1	1	-	-	1	-	-	
	Wireless charger 無線充電座	1	1	-	-	-	1	1	-	-	-	1	1	-	-	-	1	1	-	-	1	1	-	-	1	-	-	
	13A Twin Socket Outlet for Built-in Washer Dryer and Other Purpose 13A 雙位電插座供嵌入式洗衣乾衣機及其他用途	1	1	-	-	-	1	1	-	-	-	-	1	-	-	-	1	1	-	-	1	1	-	-	-	-	-	
	Connection Point for Other Purpose 接線位供其他用途	1	1	-	-	-	1	1	-	-	-	1	1	-	-	-	1	1	-	-	1	1	-	-	1	-	-	
	Connection Point for Mirror Cabinet Lighting 鏡櫃燈接線位	1	1	-	-	-	1	1	-	-	-	1	1	-	-	-	1	1	-	-	1	1	-	-	1	-	-	
	Connection Point For Exhaust Fan 抽氣扇接線位	1	1	-	-	-	1	1	-	-	-	1	1	-	-	-	1	1	-	-	1	1	-	-	1	-	-	
	Connection Point for Thermal Ventilator 浴室換氣暖風機接線位	1	1	-	-	-	1	1	-	-	-	1	1	-	-	-	1	1	-	-	1	1	-	-	1	-	-	
	Gas Water Heater Remote Controller 煤氣熱水爐遙控器	1	1	-	-	-	1	1	-	-	-	1	1	-	-	-	1	1	-	-	1	1	-	-	1	-	-	
	"Built-in Washer Dryer Connection Point (Water Inlet) 嵌入式洗衣乾衣機接駁點 (來水位)	1	1	-	-	-	1	1	-	-	-	-	1	-	-	-	1	1	-	-	1	1	-	-	-	-	-	
"Built-in Washer Dryer Connection Point (Water Outlet) 嵌入式洗衣乾衣機接駁點 (去水位)	1	1	-	-	-	1	1	-	-	-	-	1	-	-	-	1	1	-	-	1	1	-	-	-	-	-		
Bathroom 3 浴室 3	Lighting Point 燈位	-	-	-	-	-	-	-	-	-	-	-	-	-	-	-	-	-	-	-	-	-	-	-	3	-	-	
	13A Twin Socket Outlet 13A雙位電插座	-	-	-	-	-	-	-	-	-	-	-	-	-	-	-	-	-	-	-	-	-	-	-	1	-	-	
	Power Bar 多功能插蘇板	-	-	-	-	-	-	-	-	-	-	-	-	-	-	-	-	-	-	-	-	-	-	-	1	-	-	
	Wireless charger 無線充電座	-	-	-	-	-	-	-	-	-	-	-	-	-	-	-	-	-	-	-	-	-	-	-	1	-	-	
	Connection Point for Other Purpose 接線位供其他用途	-	-	-	-	-	-	-	-	-	-	-	-	-	-	-	-	-	-	-	-	-	-	-	1	-	-	
	Connection Point for Mirror Cabinet Lighting 鏡櫃燈接線位	-	-	-	-	-	-	-	-	-	-	-	-	-	-	-	-	-	-	-	-	-	-	-	1	-	-	
	Connection Point for Lighting at Roof 接線位供天台燈	-	-	-	-	-	-	-	-	-	-	-	-	-	-	-	-	-	-	-	-	-	-	-	1	-	-	
	Connection Point For Exhaust Fan 抽氣扇接線位	-	-	-	-	-	-	-	-	-	-	-	-	-	-	-	-	-	-	-	-	-	-	-	1	-	-	
	Connection Point for Thermal Ventilator 浴室換氣暖風機接線位	-	-	-	-	-	-	-	-	-	-	-	-	-	-	-	-	-	-	-	-	-	-	-	1	-	-	
	Gas Water Heater Remote Controller 煤氣熱水爐遙控器	-	-	-	-	-	-	-	-	-	-	-	-	-	-	-	-	-	-	-	-	-	-	-	1	-	-	
Connection Point For Gas Water Heater 煤氣熱水爐接線位	-	-	-	-	-	-	-	-	-	-	-	-	-	-	-	-	-	-	-	-	-	-	-	1	-	-		

Remarks :

- "1, 2," denotes the quantity of such provision(s) provided in the residential property.
- "-" denotes "not applicable".
- The quantity of the lighting switch shown in the schedule denotes the quantity of switch on/off button(s).
- 13/F, 14/F, 24/F, 34/F, 44/F and 54/F are omitted.

備註 :

- "1, 2," 表示提供於該住宅物業內的裝置數量。
- "-" 代表 "不適用"。
- 說明表所顯示的燈掣數量是表示燈掣開/關的數量。
- 不設13樓、14樓、24樓、34樓、44樓及54樓。

Fittings, finishes and appliances

裝置、裝修物料及設備

Schedule of Mechanical & Electrical Provisions of Residential Properties 住宅物業機電裝置數量說明表

Location 位置	Description 描述	Tower 5 (5A) 第5座 (5A)															Tower 5 (5B) 第5座 (5B)											
		7/F 7樓					8/F-12/F, 15/F-16/F, 18/F-23/F, 25/F-33/F, 35/F-39/F, 41/F-43/F, 45/F-53/F & 55/F-61/F 8樓至12樓, 15樓至16樓, 18樓至23樓, 25樓至33樓, 35樓至39樓, 41樓至43樓, 45樓至53樓及55樓至61樓					62/F 62樓					7/F 7樓				8/F-12/F, 15/F-16/F, 18/F-23/F, 25/F-33/F, 35/F-39/F, 41/F-43/F, 45/F-53/F & 55/F-61/F 8樓至12樓, 15樓至16樓, 18樓至23樓, 25樓至33樓, 35樓至39樓, 41樓至43樓, 45樓至53樓及55樓至61樓					62/F 62樓		
		A	B	C	D	E	A	B	C	D	E	A	B	D	E	A	B	C	D	A	B	C	D	A	C	D		
Kitchen 廚房	Lighting Point 燈位	2	2	-	2	-	2	2	-	2	-	2	2	2	-	2	2	2	2	2	2	2	2	2	2	2		
	Door Bell 門鈴	1	1	-	1	-	1	1	-	1	-	-	1	1	-	1	1	1	1	1	1	1	1	-	1	1		
	13A Twin Socket Outlet with USB 13A雙位電插座配USB插座	2	2	-	2	-	2	2	-	2	-	3	2	2	-	2	2	2	2	2	2	2	2	3	2	2		
	Connection Point for Built-in 2 Door Refrigerator, Bottom Freezer 嵌入式雙門雪櫃接線位	1	1	-	1	-	1	1	-	1	-	-	1	1	-	1	1	1	1	1	1	1	1	-	1	1		
	Connection Point for Built-in Fridge-Freezer 嵌入式雪櫃連冰箱接線位	-	-	-	-	-	-	-	-	-	-	1	-	-	-	-	-	-	-	-	-	-	-	1	-	-		
	Connection Point for Exhaust Fan 抽氣扇接線位	1	1	-	1	-	1	1	-	1	-	1	1	1	-	1	1	1	1	1	1	1	1	1	1	1		
	Connection Point for Kitchen Cabinet Lighting 廚房櫃燈接線位	1	1	-	1	-	1	1	-	1	-	1	1	1	-	1	1	1	1	1	1	1	1	1	1	1		
	Connection Point for Lighting at Flat Roof 接線位供平台燈	1	1	-	1	-	-	-	-	-	-	-	-	-	-	1	1	-	1	-	-	-	-	-	-	-		
	Connection Point for Lighting at Roof 接線位供天台燈	-	-	-	-	-	-	-	-	-	-	1	1	1	-	-	-	-	-	-	-	-	-	1	-	1		
	Connection Point for Barbecue Grill 燒烤爐接線位	-	-	-	-	-	-	-	-	-	-	1	-	-	-	-	-	-	-	-	-	-	-	1	-	-		
	Connection Point for Built-in Oven with Microwave 嵌入式微波焗爐接線位	-	1	-	1	-	-	1	-	1	-	-	1	1	-	-	-	1	1	-	-	1	1	-	1	1		
	Connection Point for Oven with Microwave 微波焗爐接線位	1	-	-	-	-	1	-	-	-	-	1	-	-	-	1	1	-	-	1	1	-	-	1	-	-		
	Connection Point for Steam Oven 蒸爐接線位	-	-	-	-	-	-	-	-	-	-	1	-	-	-	-	-	-	-	-	-	-	-	1	-	-		
	Connection Point for Gas Water Heater 煤氣熱水爐接線位	1	1	-	1	-	1	1	-	1	-	-	1	1	-	1	1	1	1	1	1	1	1	-	1	1		
	Connection Point for Gas Hob 氣體煮食爐接線位	2	2	-	2	-	2	2	-	2	-	2	2	2	-	2	2	2	2	2	2	2	2	2	2	2		
	Connection Point for 90cm Telescopic Hood 90厘米拉趟式抽油煙機接線位	1	1	-	1	-	1	1	-	1	-	-	1	1	-	1	1	1	1	1	1	1	1	-	1	1		
	Connection Point for Cooker Hood 抽油煙機接線位	-	-	-	-	-	-	-	-	-	-	1	-	-	-	-	-	-	-	-	-	-	-	1	-	-		
Connection Point for Indoor Air-Conditioner Unit 室內空調機接線位	-	-	-	-	-	-	-	-	-	-	1	-	-	-	-	-	-	-	-	-	-	-	1	-	-			
Miniature Circuit Breakers Board 總電掣箱	1	1	-	1	-	1	1	-	1	-	-	1	1	-	1	1	1	1	1	1	1	1	-	1	1			

Remarks :

- “1, 2,” denotes the quantity of such provision(s) provided in the residential property.
- “-” denotes “not applicable”.
- The quantity of the lighting switch shown in the schedule denotes the quantity of switch on/off button(s).
- 13/F, 14/F, 24/F, 34/F, 44/F and 54/F are omitted.

備註 :

- “1, 2,” 表示提供於該住宅物業內的裝置數量。
- “-” 代表 “不適用”。
- 說明表所顯示的燈掣數量是表示燈掣開/關的數量。
- 不設13樓、14樓、24樓、34樓、44樓及54樓。

Fittings, finishes and appliances

裝置、裝修物料及設備

Schedule of Mechanical & Electrical Provisions of Residential Properties 住宅物業機電裝置數量說明表

Location 位置	Description 描述	Tower 5 (5A) 第5座 (5A)															Tower 5 (5B) 第5座 (5B)											
		7/F 7樓					8/F-12/F, 15/F-16/F, 18/F-23/F, 25/F-33/F, 35/F-39/F, 41/F-43/F, 45/F-53/F & 55/F-61/F 8樓至12樓, 15樓至16樓, 18樓至23樓, 25樓至33樓, 35樓至39樓, 41樓至43樓, 45樓至53樓及55樓至61樓					62/F 62樓					7/F 7樓				8/F-12/F, 15/F-16/F, 18/F-23/F, 25/F-33/F, 35/F-39/F, 41/F-43/F, 45/F-53/F & 55/F-61/F 8樓至12樓, 15樓至16樓, 18樓至23樓, 25樓至33樓, 35樓至39樓, 41樓至43樓, 45樓至53樓及55樓至61樓				62/F 62樓			
		A	B	C	D	E	A	B	C	D	E	A	B	D	E	A	B	C	D	A	B	C	D	A	C	D		
Open Kitchen 開放式廚房	Lighting Point 燈位	-	-	1	-	-	-	-	1	-	-	-	-	-	-	-	-	-	-	-	-	-	-	-	-			
	Door Bell 門鈴	-	-	1	-	1	-	-	1	-	1	-	-	-	1	-	-	-	-	-	-	-	-	-	-			
	13A Twin Socket Outlet with USB 13A雙位電插座配USB插座	-	-	1	-	1	-	-	1	-	1	-	-	-	1	-	-	-	-	-	-	-	-	-	-			
	Connection Point for Built-in 2 Door Refrigerator, Bottom Freezer 嵌入式雙門雪櫃接線位	-	-	1	-	1	-	-	1	-	1	-	-	-	1	-	-	-	-	-	-	-	-	-	-			
	Connection Point for Kitchen Cabinet Lighting 廚房櫃燈接線位	-	-	1	-	1	-	-	1	-	1	-	-	-	1	-	-	-	-	-	-	-	-	-	-			
	Connection Point for FlexInduction Plus Hob 60cm 嵌入式60厘米FlexInduction電磁爐接線位	-	-	1	-	1	-	-	1	-	1	-	-	-	1	-	-	-	-	-	-	-	-	-	-			
	Connection Point for Built-in Oven with Microwave 嵌入式微波焗爐接線位	-	-	1	-	1	-	-	1	-	1	-	-	-	1	-	-	-	-	-	-	-	-	-	-			
	Connection Point for 60cm Telescopic Hood 60厘米拉趟式抽油煙機接線位	-	-	1	-	1	-	-	1	-	1	-	-	-	1	-	-	-	-	-	-	-	-	-	-			
Miniature Circuit Breakers Board 總電掣箱	-	-	1	-	1	-	-	1	-	1	-	-	-	1	-	-	-	-	-	-	-	-	-	-				
Store 儲物房	Lighting Switch 燈掣	-	1	-	-	-	-	1	-	-	-	1	1	-	-	-	-	-	-	-	-	-	-	-				
	Lighting Point 燈位	-	1	-	-	-	-	1	-	-	-	1	1	-	-	-	-	-	-	-	-	-	-	-				
	13A Twin Socket Outlet 13A雙位電插座	-	1	-	-	-	-	1	-	-	-	-	1	-	-	-	-	-	-	-	-	-	-	-				
	Telephone Outlet 電話插座	-	1	-	-	-	-	1	-	-	-	-	1	-	-	-	-	-	-	-	-	-	-	-				
	Connection Point for Indoor Air-Conditioner Unit 室內空調機接線位	-	1	-	-	-	-	1	-	-	-	-	1	-	-	-	-	-	-	-	-	-	-	-				
Utility Room 工作間	Lighting Switch 燈掣	-	-	-	-	-	-	-	-	-	2	-	-	-	-	-	-	-	-	-	-	2	-	-				
	Lighting Point 燈位	-	-	-	-	-	-	-	-	-	1	-	-	-	-	-	-	-	-	-	-	2	-	-				
	13A Twin Socket Outlet 13A雙位電插座	-	-	-	-	-	-	-	-	-	1	-	-	-	-	-	-	-	-	-	-	1	-	-				
	Connection Point for Freestanding Washing Machine 洗衣機接線位	-	-	-	-	-	-	-	-	-	1	-	-	-	-	-	-	-	-	-	-	1	-	-				
	Connection Point for Heat Pump Tumble Dryer 乾衣機接線位	-	-	-	-	-	-	-	-	-	1	-	-	-	-	-	-	-	-	-	-	1	-	-				
	Switch for Exhaust Fan 抽氣扇開關	-	-	-	-	-	-	-	-	-	1	-	-	-	-	-	-	-	-	-	-	1	-	-				
	Connection Point for Indoor Air-Conditioner Unit 室內空調機接線位	-	-	-	-	-	-	-	-	-	1	-	-	-	-	-	-	-	-	-	-	1	-	-				
Miniature Circuit Breakers Board 總電掣箱	-	-	-	-	-	-	-	-	-	1	-	-	-	-	-	-	-	-	-	-	1	-	-					
Gas Water Heater Remote Controller 煤氣熱水爐遙控器	-	-	-	-	-	-	-	-	-	1	-	-	-	-	-	-	-	-	-	-	1	-	-					

Remarks :

- “1, 2,” denotes the quantity of such provision(s) provided in the residential property.
- “-” denotes “not applicable”.
- The quantity of the lighting switch shown in the schedule denotes the quantity of switch on/off button(s).
- 13/F, 14/F, 24/F, 34/F, 44/F and 54/F are omitted.

備註 :

- “1, 2,” 表示提供於該住宅物業內的裝置數量。
- “-” 代表 “不適用”。
- 說明表所顯示的燈掣數量是表示燈掣開/關的數量。
- 不設13樓、14樓、24樓、34樓、44樓及54樓。

Fittings, finishes and appliances

裝置、裝修物料及設備

Schedule of Mechanical & Electrical Provisions of Residential Properties 住宅物業機電裝置數量說明表

Location 位置	Description 描述	Tower 5 (5A) 第5座 (5A)												Tower 5 (5B) 第5座 (5B)															
		7/F 7樓					8/F-12/F, 15/F-16/F, 18/F-23/F, 25/F-33/F, 35/F-39/F, 41/F-43/F, 45/F-53/F & 55/F-61/F 8樓至12樓, 15樓至16樓, 18樓至23樓, 25樓至33樓, 35樓至39樓, 41樓至43樓, 45樓至53樓及55樓至61樓					62/F 62樓					7/F 7樓					8/F-12/F, 15/F-16/F, 18/F-23/F, 25/F-33/F, 35/F-39/F, 41/F-43/F, 45/F-53/F & 55/F-61/F 8樓至12樓, 15樓至16樓, 18樓至23樓, 25樓至33樓, 35樓至39樓, 41樓至43樓, 45樓至53樓及55樓至61樓					62/F 62樓		
		A	B	C	D	E	A	B	C	D	E	A	B	D	E	A	B	C	D	A	B	C	D	A	C	D			
Utility Room 工作間	Freestanding Washing Machine Connection Point (Water Inlet) 洗衣機接駁點 (來水位)	-	-	-	-	-	-	-	-	-	1	-	-	-	-	-	-	-	-	-	-	1	-	-					
	Freestanding Washing Machine Connection Point (Water Outlet) 洗衣機接駁點 (去水位)	-	-	-	-	-	-	-	-	-	1	-	-	-	-	-	-	-	-	-	-	1	-	-					
	Freestanding Tumble Dryer Connection Point (Water Outlet) 乾衣機接駁點 (去水位)	-	-	-	-	-	-	-	-	-	1	-	-	-	-	-	-	-	-	-	-	1	-	-					
Toilet 洗手間	Lighting Point 燈位	-	-	-	-	-	-	-	-	-	1	-	-	-	-	-	-	-	-	-	-	1	-	-					
	Connection Point for Exhaust Fan 抽氣扇接線位	-	-	-	-	-	-	-	-	-	1	-	-	-	-	-	-	-	-	-	-	1	-	-					
	Connection Point for Gas Water Heater 煤氣熱水爐接線位	-	-	-	-	-	-	-	-	-	2	-	-	-	-	-	-	-	-	-	-	1	-	-					
Utility Platform 工作平台	Lighting Point 燈位	-	-	-	-	-	1	1	1	1	1	1	1	1	-	1	-	-	1	1	1	1	1	1	1				
Balcony 露台	Lighting Point 燈位	-	-	-	-	-	1	1	1	1	1	1	1	1	-	-	-	-	1	1	1	1	1	1	1				
Flat Roof 平台	Lighting Point 燈位	2	2	2	1	2	-	-	-	-	-	-	-	-	2	1	2	1	-	-	-	-	-	-	-				
	13A Single Watertight Socket Outlet 13A單位防水電插座	1	1	1	1	1	-	-	-	-	-	-	-	-	1	1	1	1	-	-	-	-	-	-	-				
Air-Conditioner Platform 空調機平台	Isolator for Outdoor Air-Conditioner 室外空調機開關掣	3	2	2	2	2	3	2	2	2	2	5	2	2	2	3	3	2	2	3	3	2	2	6	2	2			
Roof 天台	Gas Point for Future Connection 煤氣供氣位作將來接駁用途	-	-	-	-	-	-	-	-	-	1	-	-	-	-	-	-	-	-	-	-	1	-	-					
	Watertight Lighting Switch 防水燈掣	-	-	-	-	-	-	-	-	-	1	1	1	1	-	-	-	-	-	-	-	1	1	1					
	13A Single Watertight Socket Outlet 13A單位防水電插座	-	-	-	-	-	-	-	-	-	4	1	1	1	-	-	-	-	-	-	-	4	1	1					
	Connection Point for Lighting Point 燈位接線位	-	-	-	-	-	-	-	-	-	1	1	1	1	-	-	-	-	-	-	-	1	1	1					

Remarks :

- "1, 2," denotes the quantity of such provision(s) provided in the residential property.
- "-" denotes "not applicable".
- The quantity of the lighting switch shown in the schedule denotes the quantity of switch on/off button(s).
- 13/F, 14/F, 24/F, 34/F, 44/F and 54/F are omitted.

備註 :

- "1, 2," 表示提供於該住宅物業內的裝置數量。
- "-" 代表 "不適用"。
- 說明表所顯示的燈掣數量是表示燈掣開/關的數量。
- 不設13樓、14樓、24樓、34樓、44樓及54樓。

Fittings, finishes and appliances

裝置、裝修物料及設備

Schedule of Mechanical & Electrical Provisions of Residential Properties 住宅物業機電裝置數量說明表

Location 位置	Description 描述	Tower 6 (6A) 第6座 (6A)										Tower 6 (6B) 第6座 (6B)																										
		7/F 7樓					8/F-12/F, 15/F-16/F, 18/F-23/F, 25/F-33/F, 35/F-39/F, 41/F-43/F, 45/F-53/F & 55/F-61/F 8樓至12樓, 15樓至16樓, 18樓至23樓, 25樓至33樓, 35樓至39樓, 41樓至43樓, 45樓至53樓及55樓至61樓					62/F 62樓					7/F 7樓							8/F-12/F, 15/F-16/F, 18/F-23/F, 25/F-33/F & 35/F-39/F 8樓至12樓, 15樓至16樓, 18樓至23樓, 25樓至33樓 及35樓至39樓							41/F-43/F, 45/F-53/F & 55/F-61/F 41樓至43樓, 45樓至53樓及 55樓至61樓				62/F 62樓			
		A	B	C	D	E	A	B	C	D	E	A	C	D	E	A	C	D	E	F	A	C	D	E	F	A	C	E	F	A	C	E	F					
Flat Entrance 大門入口	Door Bell Push Button 門鈴按鈕	1	1	1	1	1	1	1	1	1	1	1	1	1	1	1	1	1	1	1	1	1	1	1	1	1	1	1	1	1	1	1	1	1				
Living Room / Dining Room / Corridor 客廳 / 飯廳 / 走廊	Master Lighting Switch 燈掣總開關	1	1	1	1	1	1	1	1	1	1	1	1	1	1	1	1	1	1	1	1	1	1	1	1	1	1	1	1	1	1	1	1	1				
	Lighting Switch 燈掣	12	11	10	10	10	12	11	10	10	10	14	10	10	10	10	11	7	7	10	10	10	11	7	7	10	10	12	7	10	10	12	7	10				
	Lighting Point 燈位	5	5	4	4	5	5	5	4	4	5	13	4	4	5	4	4	3	3	4	4	4	4	3	3	4	4	5	3	4	4	4	5	3	4			
	Switch for Exhaust Fan 抽氣扇開關	2	2	1	1	1	2	2	1	1	1	2	1	1	1	2	2	1	-	1	2	2	2	1	-	1	2	2	-	1	2	2	-	1				
	Switch for Electric Water Heater 電熱水爐開關	-	-	1	1	-	-	-	1	1	-	-	1	1	-	-	-	1	-	-	-	-	-	1	-	-	-	-	-	-	-	-	-	-				
	Connection Point for Kitchen Cabinet Lighting 廚房櫃燈接線位	-	-	-	-	-	-	-	-	-	-	-	-	-	-	-	-	1	-	-	-	-	-	1	-	-	-	-	-	-	-	-	-	-				
	Video Door Phone 視像對講機	1	1	1	1	1	1	1	1	1	1	1	1	1	1	1	1	1	1	1	1	1	1	1	1	1	1	1	1	1	1	1	1	1				
	13A Twin Socket Outlet 13A雙位電插座	4	4	4	4	4	4	4	4	4	4	6	4	4	4	4	4	3	3	4	4	4	4	3	3	4	4	4	3	4	4	4	3	4				
	13A Single Socket Outlet with USB Outlet 13A單位電插座配USB插座	-	-	-	-	-	-	-	-	-	-	1	-	-	-	-	-	-	-	-	-	-	-	-	-	-	-	-	-	-	-	-	-	-				
	13A Twin Socket Outlet with USB Outlet 13A雙位電插座配USB插座	-	-	-	-	-	-	-	-	-	-	1	-	-	-	-	-	-	-	-	-	-	-	-	-	-	-	-	-	-	-	-	-	-				
	Connection Point for Lighting 燈位接線位	-	-	-	-	-	-	-	-	-	-	2	-	-	-	-	-	-	-	-	-	-	-	-	-	-	-	-	-	-	-	-	-	-				
	Connection Point for Lighting at Flat Roof 接線位供天台燈	-	-	-	-	-	-	-	-	-	-	-	-	-	-	-	-	-	-	-	-	-	-	-	-	-	-	-	-	-	-	-	-	-				
	Connection Point for Electric Water heater 電熱水爐接線位	-	-	-	-	-	-	-	-	-	-	-	-	-	-	-	-	1	-	-	-	-	-	1	-	-	-	-	-	-	-	-	-	-				
	Connection Point for Built-in Fridge-freezer 嵌入式雪櫃連冰箱接線位	-	-	-	-	-	-	-	-	-	-	1	-	-	-	-	-	-	-	-	-	-	-	-	-	-	-	-	-	-	-	-	-	-				
	Connection Point for Mastercool Wine Conditioning Unit Mastercool 酒櫃接線位	-	-	-	-	-	-	-	-	-	-	1	-	-	-	-	-	-	-	-	-	-	-	-	-	-	-	-	-	-	-	-	-	-				
	Connection Point for Coffee Machine 咖啡機接線位	-	-	-	-	-	-	-	-	-	-	1	-	-	-	-	-	-	-	-	-	-	-	-	-	-	-	-	-	-	-	-	-	-				
	Connection Point for Gourmet Warming Drawer 食物保溫櫃接線位	-	-	-	-	-	-	-	-	-	-	1	-	-	-	-	-	-	-	-	-	-	-	-	-	-	-	-	-	-	-	-	-	-				
	TV/FM Outlet 電視/電台插座	2	2	2	2	2	2	2	2	2	2	2	2	2	2	2	2	2	2	2	2	2	2	2	2	2	2	2	2	2	2	2	2	2				
Telephone Outlet 電話插座	2	2	2	2	2	2	2	2	2	2	2	2	2	2	2	2	2	2	2	2	2	2	2	2	2	2	2	2	2	2	2	2	2					
Connection point for Indoor Air-Conditioner Unit 室內空調機接線位	1	1	1	1	1	1	1	1	1	1	2	1	1	1	1	1	1	1	1	1	1	1	1	1	1	1	2	1	1	1	2	1	1					

Remarks :

- “1, 2,” denotes the quantity of such provision(s) provided in the residential property.
- “-” denotes “not applicable”.
- The quantity of the lighting switch shown in the schedule denotes the quantity of switch on/off button(s).
- 13/F, 14/F, 24/F, 34/F, 44/F and 54/F are omitted.

備註 :

- “1, 2,” 表示提供於該住宅物業內的裝置數量。
- “-” 代表 “不適用”。
- 說明表所顯示的燈掣數量是表示燈掣開/關的數量。
- 不設13樓、14樓、24樓、34樓、44樓及54樓。

Fittings, finishes and appliances

裝置、裝修物料及設備

Schedule of Mechanical & Electrical Provisions of Residential Properties 住宅物業機電裝置數量說明表

Location 位置	Description 描述	Tower 6 (6A) 第6座 (6A)										Tower 6 (6B) 第6座 (6B)																								
		7/F 7樓					8/F-12/F, 15/F-16/F, 18/F-23/F, 25/F-33/F, 35/F-39/F, 41/F-43/F, 45/F-53/F & 55/F-61/F 8樓至12樓, 15樓至16樓, 18樓至23樓, 25樓至33樓, 35樓至39樓, 41樓至43樓, 45樓至53樓及55樓至61樓					62/F 62樓					7/F 7樓					8/F-12/F, 15/F-16/F, 18/F-23/F, 25/F-33/F & 35/F-39/F 8樓至12樓, 15樓至16樓, 18樓至23樓, 25樓至33樓 及35樓至39樓					41/F-43/F, 45/F-53/F & 55/F-61/F 41樓至43樓, 45樓至53樓及 55樓至61樓					62/F 62樓				
		A	B	C	D	E	A	B	C	D	E	A	C	D	E	A	C	D	E	F	A	C	D	E	F	A	C	E	F	A	C	E	F			
Master Bedroom 主人睡房	Lighting Switch 燈掣	4	4	1	2	2	4	4	2	2	2	4	2	2	2	4	2	-	3	2	4	2	-	3	2	4	4	3	2	4	4	3	2			
	Lighting Point 燈位	2	1	1	1	1	2	1	1	1	1	2	1	1	1	2	1	-	1	1	2	1	-	1	1	2	2	1	1	2	2	1	1			
	Switch for Exhaust Fan 抽氣扇開關	1	1	-	-	-	1	1	-	-	-	1	-	-	-	1	-	-	1	-	1	-	-	1	-	1	1	1	-	1	1	1	-			
	Switch for Electric Water Heater 電熱水爐開關	-	-	-	-	-	-	-	-	-	-	-	-	-	-	-	-	-	1	-	-	-	-	1	-	-	-	1	-	-	-	1	-			
	13A Single Socket Outlet 13A單位電插座	-	-	-	-	-	-	-	-	-	-	1	-	-	-	-	-	-	-	-	-	-	-	-	-	-	-	-	-	-	-	-	-			
	13A Twin Socket Outlet 13A雙位電插座	2	2	2	2	2	2	2	2	2	2	3	2	2	2	2	2	-	2	2	2	2	-	2	2	2	2	2	2	2	2	2	2			
	TV/FM Outlet 電視/電台插座	1	1	1	1	1	1	1	1	1	1	2	1	1	1	1	1	-	1	1	1	1	-	1	1	1	1	1	1	1	1	1	1			
	Telephone Outlet 電話插座	1	1	1	1	1	1	1	1	1	1	2	1	1	1	1	1	-	1	1	1	1	-	1	1	1	1	1	1	1	1	1	1			
Connection point for Indoor Air-Conditioner Unit 室內空調機接線位	1	1	1	1	1	1	1	1	1	1	1	1	1	1	1	1	-	1	1	1	1	-	1	1	1	1	1	1	1	1	1	1				
Bedroom 1 睡房 1	Lighting Switch 燈掣	1	1	1	1	1	1	1	1	1	3	1	1	1	1	1	-	-	1	1	1	-	-	1	1	1	-	1	1	1	-	1				
	Lighting Point 燈位	1	1	1	1	1	1	1	1	1	2	1	1	1	1	1	-	-	1	1	1	-	-	1	1	1	-	1	1	1	-	1				
	Switch for Exhaust Fan 抽氣扇開關	-	-	-	-	-	-	-	-	-	1	-	-	-	-	-	-	-	-	-	-	-	-	-	-	-	-	-	-	-	-	-				
	13A Single Socket Outlet 13A單位電插座	1	1	1	1	1	1	1	1	1	-	1	1	1	1	1	-	-	1	1	1	-	-	1	1	1	-	1	1	1	-	1				
	13A Twin Socket Outlet 13A雙位電插座	1	1	1	1	1	1	1	1	1	2	1	1	1	1	1	-	-	1	1	1	-	-	1	1	1	-	1	1	1	-	1				
	TV/FM Outlet 電視/電台插座	1	1	1	1	1	1	1	1	1	2	1	1	1	1	1	-	-	1	1	1	-	-	1	1	1	-	1	1	1	-	1				
	Telephone Outlet 電話插座	1	1	1	1	1	1	1	1	1	2	1	1	1	1	1	-	-	1	1	1	-	-	1	1	1	-	1	1	1	-	1				
	Connection point for Indoor Air-Conditioner Unit 室內空調機接線位	1	1	1	1	1	1	1	1	1	1	1	1	1	1	1	1	-	-	1	1	1	-	-	1	1	1	-	1	1	1	-	1			
Bedroom 2 睡房 2	Lighting Switch 燈掣	1	-	-	-	-	1	-	-	-	1	-	-	-	1	-	-	-	-	1	-	-	-	-	1	1	-	-	1	1	-	-				
	Lighting Point 燈位	1	-	-	-	-	1	-	-	-	1	-	-	-	1	-	-	-	-	1	-	-	-	-	1	1	-	-	1	1	-	-				
	13A Single Socket Outlet 13A單位電插座	1	-	-	-	-	1	-	-	-	1	-	-	-	1	-	-	-	-	1	-	-	-	-	1	1	-	-	1	1	-	-				
	13A Twin Socket Outlet 13A雙位電插座	1	-	-	-	-	1	-	-	-	1	-	-	-	1	-	-	-	-	1	-	-	-	-	1	1	-	-	1	1	-	-				
	TV/FM Outlet 電視/電台插座	1	-	-	-	-	1	-	-	-	1	-	-	-	1	-	-	-	-	1	-	-	-	-	1	1	-	-	1	1	-	-				
	Telephone Outlet 電話插座	1	-	-	-	-	1	-	-	-	1	-	-	-	1	-	-	-	-	1	-	-	-	-	1	1	-	-	1	1	-	-				
	Connection point for Indoor Air-Conditioner Unit 室內空調機接線位	1	-	-	-	-	1	-	-	-	1	-	-	-	1	-	-	-	-	1	-	-	-	-	1	1	-	-	1	1	-	-				
Bedroom 3 睡房 3	Lighting Switch 燈掣	-	-	-	-	-	-	-	-	-	1	-	-	-	-	-	-	-	-	-	-	-	-	-	-	-	-	-	-	-	-	-				
	Lighting Point 燈位	-	-	-	-	-	-	-	-	-	1	-	-	-	-	-	-	-	-	-	-	-	-	-	-	-	-	-	-	-	-	-				
	13A Single Socket Outlet 13A單位電插座	-	-	-	-	-	-	-	-	-	1	-	-	-	-	-	-	-	-	-	-	-	-	-	-	-	-	-	-	-	-	-				
	13A Twin Socket Outlet 13A雙位電插座	-	-	-	-	-	-	-	-	-	1	-	-	-	-	-	-	-	-	-	-	-	-	-	-	-	-	-	-	-	-	-				
	TV/FM Outlet 電視/電台插座	-	-	-	-	-	-	-	-	-	1	-	-	-	-	-	-	-	-	-	-	-	-	-	-	-	-	-	-	-	-	-				
	Telephone Outlet 電話插座	-	-	-	-	-	-	-	-	-	1	-	-	-	-	-	-	-	-	-	-	-	-	-	-	-	-	-	-	-	-	-				
	Connection point for Indoor Air-Conditioner Unit 室內空調機接線位	-	-	-	-	-	-	-	-	-	1	-	-	-	-	-	-	-	-	-	-	-	-	-	-	-	-	-	-	-	-	-				

Remarks :

- “1, 2,” denotes the quantity of such provision(s) provided in the residential property.
- “-” denotes “not applicable”.
- The quantity of the lighting switch shown in the schedule denotes the quantity of switch on/off button(s).
- 13/F, 14/F, 24/F, 34/F, 44/F and 54/F are omitted.

備註 :

- “1, 2,” 表示提供於該住宅物業內的裝置數量。
- “-” 代表 “不適用”。
- 說明表所顯示的燈掣數量是表示燈掣開/關的數量。
- 不設13樓、14樓、24樓、34樓、44樓及54樓。

Fittings, finishes and appliances

裝置、裝修物料及設備

Schedule of Mechanical & Electrical Provisions of Residential Properties 住宅物業機電裝置數量說明表

Location 位置	Description 描述	Tower 6 (6A) 第6座 (6A)												Tower 6 (6B) 第6座 (6B)																					
		7/F 7樓					8/F-12/F, 15/F-16/F, 18/F-23/F, 25/F-33/F, 35/F-39/F, 41/F-43/F, 45/F-53/F & 55/F-61/F 8樓至12樓, 15樓至16樓, 18樓至23樓, 25樓至33樓, 35樓至39樓, 41樓至43樓, 45樓至53樓及55樓至61樓					62/F 62樓					7/F 7樓					8/F-12/F, 15/F-16/F, 18/F-23/F, 25/F-33/F & 35/F-39/F 8樓至12樓, 15樓至16樓, 18樓至23樓, 25樓至33樓 及35樓至39樓					41/F-43/F, 45/F-53/F & 55/F-61/F 41樓至43樓, 45樓至53樓及 55樓至61樓					62/F 62樓			
		A	B	C	D	E	A	B	C	D	E	A	C	D	E	A	C	D	E	F	A	C	D	E	F	A	C	E	F	A	C	E	F		
Bathroom 浴室	Lighting Point 燈位	-	-	3	3	3	-	-	3	3	3	-	3	3	3	-	3	3	3	3	-	3	3	3	3	-	-	3	3	-	-	3	3		
	13A Twin Socket Outlet 13A雙位電插座	-	-	1	1	1	-	-	1	1	1	-	1	1	1	-	1	1	1	1	-	1	1	1	1	-	-	1	1	-	-	1	1		
	Power Bar 多功能插蘇板	-	-	1	1	1	-	-	1	1	1	-	1	1	1	-	1	1	1	1	-	1	1	1	1	-	-	1	1	-	-	1	1		
	Wireless charger 無線充電座	-	-	1	1	1	-	-	1	1	1	-	1	1	1	-	1	1	1	1	-	1	1	1	1	-	-	1	1	-	-	1	1		
	13A Twin Socket Outlet for Built-in Washer Dryer and Other Purpose 13A 雙位電插座供嵌入式洗衣乾衣機及其他用途	-	-	1	1	1	-	-	1	1	1	-	1	1	1	-	1	1	1	1	-	1	1	1	1	-	-	1	1	-	-	1	1		
	Connection Point for Other Purpose 接線位供其他用途	-	-	1	1	1	-	-	1	1	1	-	1	1	1	-	1	1	1	1	-	1	1	1	1	-	-	1	1	-	-	1	1		
	Connection Point for Mirror Cabinet Lighting 鏡櫃燈接線位	-	-	1	1	1	-	-	1	1	1	-	1	1	1	-	1	1	1	1	-	1	1	1	1	-	-	1	1	-	-	1	1		
	Connection Point for Lighting at Roof 接線位供天台燈	-	-	-	-	-	-	-	-	-	-	-	1	1	1	-	-	-	-	-	-	-	-	-	-	-	-	-	-	-	-	1	1		
	Connection Point For Exhaust Fan 抽氣扇接線位	-	-	1	1	1	-	-	1	1	1	-	1	1	1	-	1	1	1	1	-	1	1	1	1	-	-	1	1	-	-	1	1		
	Connection Point for Thermal Ventilator 浴室換氣暖風機接線位	-	-	1	1	1	-	-	1	1	1	-	1	1	1	-	1	1	1	1	-	1	1	1	1	-	-	1	1	-	-	1	1		
	Gas Water Heater Remote Controller 煤氣熱水爐遙控器	-	-	-	-	1	-	-	-	-	1	-	-	-	1	-	1	-	-	1	-	1	-	-	1	-	-	-	1	-	-	-	1		
	Connection Point for Gas Water Heater 煤氣熱水爐接線位	-	-	-	-	1	-	-	-	-	1	-	-	-	1	-	-	-	-	1	-	-	-	-	1	-	-	-	1	-	-	-	1		
	Connection Point for Electric Water heater 電熱水爐接線位	-	-	1	1	-	-	-	1	1	-	-	1	1	-	-	-	-	-	1	-	-	-	-	1	-	-	-	1	-	-	-	1		
	Electric Water Heater Temperature Control 電熱水爐溫度控制	-	-	1	1	-	-	-	1	1	-	-	1	1	-	-	-	-	-	1	-	-	-	-	1	-	-	-	1	-	-	-	1		
	Built-in Washer Dryer Connection Point (Water Inlet) 嵌入式洗衣乾衣機接駁點 (來水位)	-	-	1	1	1	-	-	1	1	1	-	1	1	1	-	1	1	1	1	-	1	1	1	1	-	-	1	1	-	-	1	1		
Built-in Washer Dryer Connection Point (Water Outlet) 嵌入式洗衣乾衣機接駁點 (去水位)	-	-	1	1	1	-	-	1	1	1	-	1	1	1	-	1	1	1	1	-	1	1	1	1	-	-	1	1	-	-	1	1			
Bathroom 1 浴室 1	Lighting Point 燈位	3	3	-	-	-	3	3	-	-	-	5	-	-	-	3	-	-	-	-	3	-	-	-	-	3	4	-	-	3	4	-	-		
	13A Twin Socket Outlet 13A雙位電插座	1	1	-	-	-	1	1	-	-	-	2	-	-	-	1	-	-	-	-	1	-	-	-	-	1	1	-	-	1	1	-	-		
	Power Bar 多功能插蘇板	1	1	-	-	-	1	1	-	-	-	1	-	-	-	1	-	-	-	-	1	-	-	-	-	1	1	-	-	1	1	-	-		
	Wireless charger 無線充電座	1	1	-	-	-	1	1	-	-	-	1	-	-	-	1	-	-	-	-	1	-	-	-	-	1	1	-	-	1	1	-	-		
	Connection Point for Other Purpose 接線位供其他用途	1	1	-	-	-	1	1	-	-	-	1	-	-	-	1	-	-	-	-	1	-	-	-	-	1	1	-	-	1	1	-	-		
	Connection Point for Mirror Cabinet Lighting 鏡櫃燈接線位	1	1	-	-	-	1	1	-	-	-	1	-	-	-	1	-	-	-	-	1	-	-	-	-	1	1	-	-	1	1	-	-		
	Connection Point for Lighting at Roof 接線位供天台燈	-	-	-	-	-	-	-	-	-	-	1	-	-	-	-	-	-	-	-	-	-	-	-	-	-	-	-	-	1	1	-	-		
	Connection Point For Exhaust Fan 抽氣扇接線位	1	1	-	-	-	1	1	-	-	-	1	-	-	-	1	-	-	-	-	1	-	-	-	-	1	1	-	-	1	1	-	-		
	Connection Point for Thermal Ventilator 浴室換氣暖風機接線位	1	1	-	-	-	1	1	-	-	-	1	-	-	-	1	-	-	-	-	1	-	-	-	-	1	1	-	-	1	1	-	-		
	Gas Water Heater Remote Controller 煤氣熱水爐遙控器	1	1	-	-	-	1	1	-	-	-	1	-	-	-	1	-	-	-	-	1	-	-	-	-	1	1	-	-	1	1	-	-		
Connection Point For Gas Water Heater 煤氣熱水爐接線位	-	-	-	-	-	-	-	-	-	-	2	-	-	-	-	-	-	-	-	-	-	-	-	-	-	-	-	-	-	-	-	-			

Remarks :

- "1, 2," denotes the quantity of such provision(s) provided in the residential property.
- "-" denotes "not applicable".
- The quantity of the lighting switch shown in the schedule denotes the quantity of switch on/off button(s).
- 13/F, 14/F, 24/F, 34/F, 44/F and 54/F are omitted.

備註 :

- "1, 2," 表示提供於該住宅物業內的裝置數量。
- "-" 代表 "不適用"。
- 說明表所顯示的燈掣數量是表示燈掣開/關的數量。
- 不設13樓、14樓、24樓、34樓、44樓及54樓。

Fittings, finishes and appliances

裝置、裝修物料及設備

Schedule of Mechanical & Electrical Provisions of Residential Properties 住宅物業機電裝置數量說明表

Location 位置	Description 描述	Tower 6 (6A) 第6座 (6A)										Tower 6 (6B) 第6座 (6B)																								
		7/F 7樓					8/F-12/F, 15/F-16/F, 18/F-23/F, 25/F-33/F, 35/F-39/F, 41/F-43/F, 45/F-53/F & 55/F-61/F 8樓至12樓, 15樓至16樓, 18樓至23樓, 25樓至33樓, 35樓至39樓, 41樓至43樓, 45樓至53樓及55樓至61樓					62/F 62樓					7/F 7樓					8/F-12/F, 15/F-16/F, 18/F-23/F, 25/F-33/F & 35/F-39/F 8樓至12樓, 15樓至16樓, 18樓至23樓, 25樓至33樓 及35樓至39樓					41/F-43/F, 45/F-53/F & 55/F-61/F 41樓至43樓, 45樓至53樓及 55樓至61樓					62/F 62樓				
		A	B	C	D	E	A	B	C	D	E	A	C	D	E	A	C	D	E	F	A	C	D	E	F	A	C	E	F	A	C	E	F			
Bathroom 2 浴室 2	Lighting Point 燈位	3	3	-	-	-	3	3	-	-	-	3	-	-	-	3	-	-	-	-	3	-	-	-	-	3	3	-	-	3	3	-	-			
	13A Twin Socket Outlet 13A雙位電插座	1	1	-	-	-	1	1	-	-	-	1	-	-	-	1	-	-	-	-	1	-	-	-	-	1	1	-	-	1	1	-	-			
	Power Bar 多功能插蘇板	1	1	-	-	-	1	1	-	-	-	1	-	-	-	1	-	-	-	-	1	-	-	-	-	1	1	-	-	1	1	-	-			
	Wireless charger 無線充電座	1	1	-	-	-	1	1	-	-	-	1	-	-	-	1	-	-	-	-	1	-	-	-	-	1	1	-	-	1	1	-	-			
	13A Twin Socket Outlet for Built-in Washer Dryer and Other Purpose 13A 雙位電插座供嵌入式洗衣乾衣機及其他用途	1	1	-	-	-	1	1	-	-	-	-	-	-	-	1	-	-	-	-	1	-	-	-	-	1	1	-	-	1	1	-	-			
	Connection Point for Other Purpose 接線位供其他用途	1	1	-	-	-	1	1	-	-	-	1	-	-	-	1	-	-	-	-	1	-	-	-	-	1	1	-	-	1	1	-	-			
	Connection Point for Mirror Cabinet Lighting 鏡櫃燈接線位	1	1	-	-	-	1	1	-	-	-	1	-	-	-	1	-	-	-	-	1	-	-	-	-	1	1	-	-	1	1	-	-			
	Connection Point for Lighting at Roof 接線位供天台燈	-	-	-	-	-	-	-	-	-	-	1	-	-	-	-	-	-	-	-	-	-	-	-	-	-	-	-	-	1	1	-	-			
	Connection Point For Exhaust Fan 抽氣扇接線位	1	1	-	-	-	1	1	-	-	-	1	-	-	-	1	-	-	-	-	1	-	-	-	-	1	1	-	-	1	1	-	-			
	Connection Point for Thermal Ventilator 浴室換氣暖風機接線位	1	1	-	-	-	1	1	-	-	-	1	-	-	-	1	-	-	-	-	1	-	-	-	-	1	1	-	-	1	1	-	-			
	Gas Water Heater Remote Controller 煤氣熱水爐遙控器	1	1	-	-	-	1	1	-	-	-	1	-	-	-	1	-	-	-	-	1	-	-	-	-	1	1	-	-	1	1	-	-			
	Built-in Washer Dryer Connection Point (Water Inlet) 嵌入式洗衣乾衣機接駁點 (來水位)	1	1	-	-	-	1	1	-	-	-	-	-	-	-	1	-	-	-	-	1	-	-	-	-	1	1	-	-	1	1	-	-			
Built-in Washer Dryer Connection Point (Water Outlet) 嵌入式洗衣乾衣機接駁點 (去水位)	1	1	-	-	-	1	1	-	-	-	-	-	-	-	1	-	-	-	-	1	-	-	-	-	1	1	-	-	1	1	-	-				
Bathroom 3 浴室 3	Lighting Point 燈位	-	-	-	-	-	-	-	-	-	-	3	-	-	-	-	-	-	-	-	-	-	-	-	-	-	-	-	-	-	-	-	-			
	13A Twin Socket Outlet 13A雙位電插座	-	-	-	-	-	-	-	-	-	-	1	-	-	-	-	-	-	-	-	-	-	-	-	-	-	-	-	-	-	-	-	-			
	Power Bar 多功能插蘇板	-	-	-	-	-	-	-	-	-	-	1	-	-	-	-	-	-	-	-	-	-	-	-	-	-	-	-	-	-	-	-	-			
	Wireless charger 無線充電座	-	-	-	-	-	-	-	-	-	-	1	-	-	-	-	-	-	-	-	-	-	-	-	-	-	-	-	-	-	-	-	-			
	Connection Point for Other Purpose 接線位供其他用途	-	-	-	-	-	-	-	-	-	-	1	-	-	-	-	-	-	-	-	-	-	-	-	-	-	-	-	-	-	-	-	-			
	Connection Point for Mirror Cabinet Lighting 鏡櫃燈接線位	-	-	-	-	-	-	-	-	-	-	1	-	-	-	-	-	-	-	-	-	-	-	-	-	-	-	-	-	-	-	-	-			
	Connection Point for Lighting at Roof 接線位供天台燈	-	-	-	-	-	-	-	-	-	-	1	-	-	-	-	-	-	-	-	-	-	-	-	-	-	-	-	-	-	-	-	-			
	Connection Point For Exhaust Fan 抽氣扇接線位	-	-	-	-	-	-	-	-	-	-	1	-	-	-	-	-	-	-	-	-	-	-	-	-	-	-	-	-	-	-	-	-			
Connection Point for Thermal Ventilator 浴室換氣暖風機接線位	-	-	-	-	-	-	-	-	-	-	1	-	-	-	-	-	-	-	-	-	-	-	-	-	-	-	-	-	-	-	-	-				
Gas Water Heater Remote Controller 煤氣熱水爐遙控器	-	-	-	-	-	-	-	-	-	-	1	-	-	-	-	-	-	-	-	-	-	-	-	-	-	-	-	-	-	-	-	-				

Remarks :

- "1, 2," denotes the quantity of such provision(s) provided in the residential property.
- "-" denotes "not applicable".
- The quantity of the lighting switch shown in the schedule denotes the quantity of switch on/off button(s).
- 13/F, 14/F, 24/F, 34/F, 44/F and 54/F are omitted.

備註 :

- "1, 2," 表示提供於該住宅物業內的裝置數量。
- "-" 代表 "不適用"。
- 說明表所顯示的燈掣數量是表示燈掣開/關的數量。
- 不設13樓、14樓、24樓、34樓、44樓及54樓。

Fittings, finishes and appliances

裝置、裝修物料及設備

Schedule of Mechanical & Electrical Provisions of Residential Properties 住宅物業機電裝置數量說明表

Location 位置	Description 描述	Tower 6 (6A) 第6座 (6A)										Tower 6 (6B) 第6座 (6B)																								
		7/F 7樓					8/F-12/F, 15/F-16/F, 18/F-23/F, 25/F-33/F, 35/F-39/F, 41/F-43/F, 45/F-53/F & 55/F-61/F 8樓至12樓, 15樓至16樓, 18樓至23樓, 25樓至33樓, 35樓至39樓, 41樓至43樓, 45樓至53樓及55樓至61樓					62/F 62樓					7/F 7樓					8/F-12/F, 15/F-16/F, 18/F-23/F, 25/F-33/F & 35/F-39/F 8樓至12樓, 15樓至16樓, 18樓至23樓, 25樓至33樓 及35樓至39樓					41/F-43/F, 45/F-53/F & 55/F-61/F 41樓至43樓, 45樓至53樓及 55樓至61樓					62/F 62樓				
		A	B	C	D	E	A	B	C	D	E	A	C	D	E	A	C	D	E	F	A	C	D	E	F	A	C	E	F	A	C	E	F			
Kitchen 廚房	Lighting Point 燈位	2	2	-	-	-	2	2	-	-	-	3	-	-	-	3	3	-	-	-	3	3	-	-	-	3	4	-	-	3	4	-	-			
	Door Bell 門鈴	1	1	-	-	-	1	1	-	-	-	-	-	-	-	1	1	-	-	-	1	1	-	-	-	1	1	-	-	1	1	-	-			
	13A Twin Socket Outlet with USB 13A雙位電插座配USB插座	2	2	-	-	-	2	2	-	-	-	3	-	-	-	2	2	-	-	-	2	2	-	-	-	2	2	-	-	2	2	-	-			
	Connection Point for Built-in 2 Door Refrigerator, Bottom Freezer 嵌入式雙門雪櫃接線位	1	1	-	-	-	1	1	-	-	-	-	-	-	-	1	1	-	-	-	1	1	-	-	-	1	1	-	-	1	1	-	-			
	Connection Point for Built-in Fridge-Freezer 嵌入式雪櫃連冰箱接線位	-	-	-	-	-	-	-	-	-	-	1	-	-	-	-	-	-	-	-	-	-	-	-	-	-	-	-	-	-	-	-	-			
	Connection Point for Exhaust Fan 抽氣扇接線位	1	1	-	-	-	1	1	-	-	-	1	-	-	-	1	1	-	-	-	1	1	-	-	-	1	1	-	-	1	1	-	-			
	Connection Point for Kitchen Cabinet Lighting 廚房櫃燈接線位	1	1	-	-	-	1	1	-	-	-	1	-	-	-	1	1	-	-	-	1	1	-	-	-	1	1	-	-	1	1	-	-			
	Connection Point for Lighting at Flat Roof 接線位供平台燈	1	1	-	-	-	-	-	-	-	-	-	-	-	-	1	1	-	-	-	-	-	-	-	-	-	-	-	-	-	-	-	-			
	Connection Point for Lighting at Roof 接線位供天台燈	-	-	-	-	-	-	-	-	-	-	1	-	-	-	-	-	-	-	-	-	-	-	-	-	-	-	-	-	1	-	-	-			
	Connection Point for Barbecue Grill 燒烤爐接線位	-	-	-	-	-	-	-	-	-	-	1	-	-	-	-	-	-	-	-	-	-	-	-	-	-	-	-	-	-	-	-	-			
	Connection Point for Built-in Oven with Microwave 嵌入式微波焗爐接線位	-	1	-	-	-	-	1	-	-	-	-	-	-	-	1	-	-	-	-	-	1	-	-	-	-	-	-	-	-	-	-	-			
	Connection Point for Oven with Microwave 微波焗爐接線位	1	-	-	-	-	1	-	-	-	-	1	-	-	-	1	-	-	-	-	1	-	-	-	-	1	1	-	-	1	1	-	-			
	Connection Point for Steam Oven 蒸爐接線位	-	-	-	-	-	-	-	-	-	-	1	-	-	-	-	-	-	-	-	-	-	-	-	-	-	-	-	-	-	-	-	-			
	Connection Point for Gas Water Heater 煤氣熱水爐接線位	1	1	-	-	-	1	1	-	-	-	-	-	-	-	1	1	-	-	-	1	1	-	-	-	1	1	-	-	1	1	-	-			
	Connection Point for Gas Hob 氣體煮食爐接線位	2	2	-	-	-	2	2	-	-	-	2	-	-	-	2	2	-	-	-	2	2	-	-	-	2	2	-	-	2	2	-	-			
	Connection Point for 90cm Telescopic Hood 90厘米拉趟式抽油煙機接線位	1	1	-	-	-	1	1	-	-	-	-	-	-	-	1	1	-	-	-	1	1	-	-	-	1	1	-	-	1	1	-	-			
Connection Point for Cooker Hood 抽油煙機接線位	-	-	-	-	-	-	-	-	-	-	1	-	-	-	-	-	-	-	-	-	-	-	-	-	-	-	-	-	-	-	-	-				
Connection Point for Indoor Air-Conditioner Unit 室內空調機接線位	-	-	-	-	-	-	-	-	-	-	1	-	-	-	-	-	-	-	-	-	-	-	-	-	-	-	-	-	-	-	-	-				
Miniature Circuit Breakers Board 總電掣箱	1	1	-	-	-	1	1	-	-	-	-	-	-	-	1	1	-	-	-	1	1	-	-	-	1	1	-	-	1	1	-	-				

Remarks :

- "1, 2," denotes the quantity of such provision(s) provided in the residential property.
- "-" denotes "not applicable".
- The quantity of the lighting switch shown in the schedule denotes the quantity of switch on/off button(s).
- 13/F, 14/F, 24/F, 34/F, 44/F and 54/F are omitted.

備註 :

- "1, 2," 表示提供於該住宅物業內的裝置數量。
- "-" 代表 "不適用"。
- 說明表所顯示的燈掣數量是表示燈掣開/關的數量。
- 不設13樓、14樓、24樓、34樓、44樓及54樓。

Fittings, finishes and appliances

裝置、裝修物料及設備

Schedule of Mechanical & Electrical Provisions of Residential Properties 住宅物業機電裝置數量說明表

Location 位置	Description 描述	Tower 6 (6A) 第6座 (6A)										Tower 6 (6B) 第6座 (6B)																								
		7/F 7樓					8/F-12/F, 15/F-16/F, 18/F-23/F, 25/F-33/F, 35/F-39/F, 41/F-43/F, 45/F-53/F & 55/F-61/F 8樓至12樓, 15樓至16樓, 18樓至23樓, 25樓至33樓, 35樓至39樓, 41樓至43樓, 45樓至53樓及55樓至61樓					62/F 62樓					7/F 7樓					8/F-12/F, 15/F-16/F, 18/F-23/F, 25/F-33/F & 35/F-39/F 8樓至12樓, 15樓至16樓, 18樓至23樓, 25樓至33樓 及35樓至39樓					41/F-43/F, 45/F-53/F & 55/F-61/F 41樓至43樓, 45樓至53樓及 55樓至61樓					62/F 62樓				
		A	B	C	D	E	A	B	C	D	E	A	C	D	E	A	C	D	E	F	A	C	D	E	F	A	C	E	F	A	C	E	F			
Open Kitchen 開放式廚房	Lighting Point 燈位	-	-	-	1	1	-	-	-	1	1	-	-	1	1	-	-	1	-	1	-	-	1	-	1	-	-	-	1	-	-	-	1			
	Door Bell 門鈴	-	-	1	1	1	-	-	1	1	1	-	1	1	1	-	-	1	1	1	-	-	1	1	1	-	-	1	1	-	-	1	1			
	13A Twin Socket Outlet with USB 13A雙位電插座配USB插座	-	-	1	1	1	-	-	1	1	1	-	1	1	1	-	-	1	1	1	-	-	1	1	1	-	-	1	1	-	-	1	1			
	Connection Point for Built-in 2 Door Refrigerator, Bottom Freezer 嵌入式雙門雪櫃接線位	-	-	1	1	1	-	-	1	1	1	-	1	1	1	-	-	-	-	1	-	-	-	-	1	-	-	-	1	-	-	-	1			
	Connection Point for Built-in 1 Door Refrigerator, Top Freezer 嵌入式單門雪櫃接線位	-	-	-	-	-	-	-	-	-	-	-	-	-	-	-	-	-	-	1	-	-	-	-	1	-	-	-	1	-	-	-	1			
	Connection Point for Kitchen Cabinet Lighting 廚房櫃燈接線位	-	-	1	1	1	-	-	1	1	1	-	1	1	1	-	-	-	1	1	-	-	-	1	1	-	-	1	1	-	-	1	1			
	Connection Point for Lighting at Flat Roof 接線位供平台燈	-	-	1	1	1	-	-	-	-	-	-	-	-	-	-	-	-	-	1	-	-	-	-	-	-	-	-	-	-	-	-	-			
	Connection Point for Lighting at Roof 接線位供天台燈	-	-	-	-	-	-	-	-	-	-	-	1	-	1	-	-	-	-	-	-	-	-	-	-	-	-	-	-	-	-	-	-			
	Connection Point for Built-in Undercounter Refrigerator 嵌入式台下雪櫃接線位	-	-	-	-	-	-	-	-	-	-	-	-	-	-	-	-	-	-	1	-	-	-	-	1	-	-	-	-	-	-	-	-			
	13A Single Socket Outlet for Built-In Microwave with Grill 13A 單位電插座供嵌入式微波爐與烤架	-	-	-	-	-	-	-	-	-	-	-	-	-	-	-	-	-	-	1	-	-	-	-	1	-	-	-	-	-	-	-	-			
	Connection Point for Domino 2-zone Induction Hob 嵌入式雙頭電磁爐接線位	-	-	-	-	-	-	-	-	-	-	-	-	-	-	-	-	-	-	1	1	-	-	-	1	1	-	-	-	1	-	-	-	1		
	Connection Point for FlexInduction Plus Hob 60cm 嵌入式60厘米 FlexInduction 電磁爐接線位	-	-	1	1	1	-	-	1	1	1	-	1	1	1	-	-	-	-	1	-	-	-	-	1	-	-	-	1	-	-	-	1			
	Connection Point for Built-in Oven with Microwave 嵌入式微波焗爐接線位	-	-	1	1	1	-	-	1	1	1	-	1	1	1	-	-	-	1	1	-	-	-	1	1	-	-	1	1	-	-	1	1			
	Connection Point for 60cm Telescopic Hood 60厘米拉趟式抽油煙機接線位	-	-	1	1	1	-	-	1	1	1	-	1	1	1	-	-	1	1	1	-	-	1	1	1	-	-	1	1	-	-	1	1			
	Miniature Circuit Breakers Board 總電掣箱	-	-	1	1	1	-	-	1	1	1	-	1	1	1	-	-	1	1	1	-	-	1	1	1	-	-	1	1	-	-	1	1			
Store 儲物房	Lighting Switch 燈掣	-	1	-	-	-	-	1	-	-	-	-	-	-	-	-	-	-	-	-	-	-	-	-	-	-	1	-	-	-	1	-	-			
	Lighting Point 燈位	-	1	-	-	-	-	1	-	-	-	-	-	-	-	-	-	-	-	-	-	-	-	-	-	-	1	-	-	-	1	-	-			
	13A Twin Socket Outlet 13A雙位電插座	-	1	-	-	-	-	1	-	-	-	-	-	-	-	-	-	-	-	-	-	-	-	-	-	-	1	-	-	-	1	-	-			
	Telephone Outlet 電話插座	-	1	-	-	-	-	1	-	-	-	-	-	-	-	-	-	-	-	-	-	-	-	-	-	-	1	-	-	-	1	-	-			
	Connection Point for Indoor Air-Conditioner Unit 室內空調機接線位	-	1	-	-	-	-	1	-	-	-	-	-	-	-	-	-	-	-	-	-	-	-	-	-	-	1	-	-	-	1	-	-			
Utility Room 工作間	Lighting Switch 燈掣	-	-	-	-	-	-	-	-	-	-	2	-	-	-	-	-	-	-	-	-	-	-	-	-	-	-	-	-	-	-	-	-			
	Lighting Point 燈位	-	-	-	-	-	-	-	-	-	-	2	-	-	-	-	-	-	-	-	-	-	-	-	-	-	-	-	-	-	-	-	-			
	13A Twin Socket Outlet 13A雙位電插座	-	-	-	-	-	-	-	-	-	-	1	-	-	-	-	-	-	-	-	-	-	-	-	-	-	-	-	-	-	-	-	-			

Remarks :

- "1, 2," denotes the quantity of such provision(s) provided in the residential property.
- "-" denotes "not applicable".
- The quantity of the lighting switch shown in the schedule denotes the quantity of switch on/off button(s).
- 13/F, 14/F, 24/F, 34/F, 44/F and 54/F are omitted.

備註 :

- "1, 2," 表示提供於該住宅物業內的裝置數量。
- "-" 代表 "不適用"。
- 說明表所顯示的燈掣數量是表示燈掣開/關的數量。
- 不設13樓、14樓、24樓、34樓、44樓及54樓。

Fittings, finishes and appliances

裝置、裝修物料及設備

Schedule of Mechanical & Electrical Provisions of Residential Properties 住宅物業機電裝置數量說明表

Location 位置	Description 描述	Tower 6 (6A) 第6座 (6A)										Tower 6 (6B) 第6座 (6B)																									
		7/F 7樓					8/F-12/F, 15/F-16/F, 18/F-23/F, 25/F-33/F, 35/F-39/F, 41/F-43/F, 45/F-53/F & 55/F-61/F 8樓至12樓, 15樓至16樓, 18樓至23樓, 25樓至33樓, 35樓至39樓, 41樓至43樓, 45樓至53樓及55樓至61樓					62/F 62樓					7/F 7樓					8/F-12/F, 15/F-16/F, 18/F-23/F, 25/F-33/F & 35/F-39/F 8樓至12樓, 15樓至16樓, 18樓至23樓, 25樓至33樓 及35樓至39樓					41/F-43/F, 45/F-53/F & 55/F-61/F 41樓至43樓, 45樓至53樓及 55樓至61樓					62/F 62樓					
		A	B	C	D	E	A	B	C	D	E	A	C	D	E	A	C	D	E	F	A	C	D	E	F	A	C	E	F	A	C	E	F				
Utility Room 工作間	Connection Point for Freestanding Washing Machine 洗衣機接線位	-	-	-	-	-	-	-	-	-	1	-	-	-	-	-	-	-	-	-	-	-	-	-	-	-	-	-	-	-	-	-	-	-	-	-	-
	Connection Point for Heat Pump Tumble Dryer 乾衣機接線位	-	-	-	-	-	-	-	-	-	1	-	-	-	-	-	-	-	-	-	-	-	-	-	-	-	-	-	-	-	-	-	-	-	-	-	
	Switch for Exhaust Fan 抽氣扇開關	-	-	-	-	-	-	-	-	-	1	-	-	-	-	-	-	-	-	-	-	-	-	-	-	-	-	-	-	-	-	-	-	-	-	-	
	Connection Point for Indoor Air-Conditioner Unit 室內空調機接線位	-	-	-	-	-	-	-	-	-	1	-	-	-	-	-	-	-	-	-	-	-	-	-	-	-	-	-	-	-	-	-	-	-	-	-	
	Miniature Circuit Breakers Board 總電掣箱	-	-	-	-	-	-	-	-	-	1	-	-	-	-	-	-	-	-	-	-	-	-	-	-	-	-	-	-	-	-	-	-	-	-	-	
	Gas Water Heater Remote Controller 煤氣熱水爐遙控器	-	-	-	-	-	-	-	-	-	1	-	-	-	-	-	-	-	-	-	-	-	-	-	-	-	-	-	-	-	-	-	-	-	-	-	
	Freestanding Washing Machine Connection Point (Water Inlet) 洗衣機接駁點 (來水位)	-	-	-	-	-	-	-	-	-	1	-	-	-	-	-	-	-	-	-	-	-	-	-	-	-	-	-	-	-	-	-	-	-	-	-	
	Freestanding Washing Machine Connection Point (Water Outlet) 洗衣機接駁點 (去水位)	-	-	-	-	-	-	-	-	-	1	-	-	-	-	-	-	-	-	-	-	-	-	-	-	-	-	-	-	-	-	-	-	-	-	-	
Freestanding Tumble Dryer Connection Point (Water Outlet) 乾衣機接駁點 (去水位)	-	-	-	-	-	-	-	-	-	1	-	-	-	-	-	-	-	-	-	-	-	-	-	-	-	-	-	-	-	-	-	-	-	-	-		
Toilet 洗手間	Lighting Point 燈位	-	-	-	-	-	-	-	-	-	1	-	-	-	-	-	-	-	-	-	-	-	-	-	-	-	-	-	-	-	-	-	-	-	-		
	Connection Point for Exhaust Fan 抽氣扇接線位	-	-	-	-	-	-	-	-	-	1	-	-	-	-	-	-	-	-	-	-	-	-	-	-	-	-	-	-	-	-	-	-	-	-	-	
	Connection Point for Lighting at Roof 接線位供天台燈	-	-	-	-	-	-	-	-	-	1	-	-	-	-	-	-	-	-	-	-	-	-	-	-	-	-	-	-	-	-	-	-	-	-	-	
Utility Platform 工作平台	Lighting Point 燈位	1	-	-	-	-	1	1	1	1	1	1	1	1	1	-	-	-	-	1	1	-	-	1	1	1	-	1	1	1	1	1	1	1	1	1	
Balcony 露台	Lighting Point 燈位	-	-	-	-	-	1	1	1	1	1	1	1	1	-	-	1	-	-	1	1	1	1	1	1	1	1	1	1	1	1	1	1	1	1		
	13A Single Watertight Socket Outlet 13A單位防水電插座	-	-	-	-	-	-	-	-	-	-	-	-	-	-	-	1	-	-	-	-	-	-	-	-	-	-	-	-	-	-	-	-	-	-		
Flat Roof 平台	Lighting Point 燈位	1	2	1	1	2	-	-	-	-	-	-	-	-	1	2	-	1	2	-	-	-	-	-	-	-	-	-	-	-	-	-	-	-	-		
	13A Single Watertight Socket Outlet 13A單位防水電插座	1	1	1	1	1	-	-	-	-	-	-	-	-	-	1	1	-	1	1	-	-	-	-	-	-	-	-	-	-	-	-	-	-	-		
Air-Conditioner Platform 空調機平台	Isolator for Outdoor Air-Conditioner 室外空調機開關掣	3	2	2	2	2	3	2	2	2	2	6	2	2	2	3	2	1	1	2	3	2	1	1	2	3	3	1	2	3	3	1	2	3	1	2	
Roof 天台	Gas Point for Future Connection 煤氣供氣位作將來接駁用途	-	-	-	-	-	-	-	-	-	1	-	-	-	-	-	-	-	-	-	-	-	-	-	-	-	-	-	-	-	-	-	-	-	-		
	Watertight Lighting Switch 防水燈掣	-	-	-	-	-	-	-	-	-	1	1	1	1	-	-	-	-	-	-	-	-	-	-	-	-	-	-	-	-	1	1	1	1	1		
	13A Single Watertight Socket Outlet 13A單位防水電插座	-	-	-	-	-	-	-	-	-	4	1	1	1	-	-	-	-	-	-	-	-	-	-	-	-	-	-	-	-	1	1	1	1	1		
	Connection Point for Lighting Point 燈位接線位	-	-	-	-	-	-	-	-	-	1	1	1	1	-	-	-	-	-	-	-	-	-	-	-	-	-	-	-	-	1	1	1	1	1		

Remarks :

- "1, 2," denotes the quantity of such provision(s) provided in the residential property.
- "-" denotes "not applicable".
- The quantity of the lighting switch shown in the schedule denotes the quantity of switch on/off button(s).
- 13/F, 14/F, 24/F, 34/F, 44/F and 54/F are omitted.

備註 :

- "1, 2," 表示提供於該住宅物業內的裝置數量。
- "-" 代表 "不適用"。
- 說明表所顯示的燈掣數量是表示燈掣開/關的數量。
- 不設13樓、14樓、24樓、34樓、44樓及54樓。

Fittings, finishes and appliances

裝置、裝修物料及設備

Schedule of Mechanical & Electrical Provisions of Residential Properties 住宅物業機電裝置數量說明表

Location 位置	Description 描述	Tower 7 (7A) 第7座 (7A)												Tower 7 (7B) 第7座 (7B)																					
		7/F 7樓						8/F-12/F, 15/F-16/F, 18/F-23/F, 25/F-33/F, 35/F-39/F, 41/F-43/F, 45/F-53/F & 55/F-61/F 8樓至12樓, 15樓至16樓, 18樓至23樓, 25樓至33樓, 35樓至39樓, 41樓至43樓, 45樓至53樓及55樓至61樓						62/F 62樓						7/F 7樓						8/F-12/F, 15/F-16/F, 18/F-23/F, 25/F-33/F, 35/F-39/F, 41/F-43/F, 45/F-53/F & 55/F-61/F 8樓至12樓, 15樓至16樓, 18樓至23樓, 25樓至33樓, 35樓至39樓, 41樓至43樓, 45樓至53樓及55樓至61樓						62/F 62樓			
		A	B	C	D	E	F	A	B	C	D	E	F	A	C	D	E	F	A	B	C	D	E	A	B	C	D	E	A	B	C	D			
Flat Entrance 單位入口	Door Bell Push Button 門鈴按鈕	1	1	1	1	1	1	1	1	1	1	1	1	1	1	1	1	1	1	1	1	1	1	1	1	1	1	1	1	1	1	1			
Living Room / Dining Room / Corridor 客廳 / 飯廳 / 走廊	Master Lighting Switch 燈掣總開關	1	1	1	1	1	1	1	1	1	1	1	1	1	1	1	1	1	1	1	1	1	1	1	1	1	1	1							
	Lighting Switch 燈掣	12	12	10	7	7	7	12	12	10	7	7	7	13	10	7	7	7	12	11	7	12	8	12	11	7	12	14							
	Lighting Point 燈位	5	5	4	3	3	3	5	5	4	3	3	3	12	4	3	3	3	5	5	3	6	2	5	5	3	9	9							
	Switch for Exhaust Fan 抽氣扇開關	2	2	1	-	1	-	2	2	1	-	1	-	2	1	-	1	-	2	2	1	2	2	2	2	1	2	2							
	Switch for Electric Water Heater 電熱水爐開關	-	-	-	-	1	-	-	-	-	-	1	-	-	-	1	-	-	-	1	-	-	-	-	-	1	-	-							
	Connection Point for Kitchen Cabinet Lighting 廚房櫃燈接線位	-	-	-	-	1	-	-	-	-	-	1	-	-	-	1	-	-	-	-	-	-	-	-	-	-	-	-							
	Video Door Phone 視像對講機	1	1	1	1	1	1	1	1	1	1	1	1	1	1	1	1	1	1	1	1	1	1	1	1	1	1	1							
	13A Twin Socket Outlet 13A雙位電插座	4	4	4	3	3	3	4	4	4	3	3	3	6	4	3	3	3	4	4	3	4	4	4	4	3	6	6							
	13A Single Socket Outlet with USB Outlet 13A單位電插座配USB插座	-	-	-	-	-	-	-	-	-	-	-	-	1	-	-	-	-	-	-	-	-	-	-	-	-	-	1							
	13A Twin Socket Outlet with USB Outlet 13A雙位電插座配USB插座	-	-	-	-	-	-	-	-	-	-	-	-	1	-	-	-	-	-	-	-	-	-	-	-	-	-	1							
	Connection Point for Lighting 燈位接線位	-	-	-	-	-	-	-	-	-	-	-	-	2	-	-	-	-	-	-	-	-	-	-	-	-	-	2							
	Connection Point for Lighting at Flat Roof 接線位供平台燈	-	-	1	-	1	-	-	-	-	-	-	-	-	-	-	-	-	-	-	-	-	-	-	-	-	-	-							
	Connection Point for Lighting at Roof 接線位供天台燈	-	-	-	-	-	-	-	-	-	-	-	-	-	-	-	1	-	-	-	-	-	-	-	-	-	-	-							
	Connection Point for Electric Water heater 電熱水爐接線位	-	-	-	-	1	-	-	-	-	-	1	-	-	-	1	-	-	-	-	-	-	-	-	-	-	-	-							
	Connection Point for Built-in Fridge-freezer 嵌入式雪櫃連冰箱接線位	-	-	-	-	-	-	-	-	-	-	-	-	1	-	-	-	-	-	-	-	-	-	-	-	-	-	1							
	Connection Point for Mastercool Wine Conditioning Unit Mastercool 酒櫃接線位	-	-	-	-	-	-	-	-	-	-	-	-	1	-	-	-	-	-	-	-	-	-	-	-	-	-	1							
	Connection Point for Coffee Machine 咖啡機接線位	-	-	-	-	-	-	-	-	-	-	-	-	1	-	-	-	-	-	-	-	-	-	-	-	-	-	1							
	Connection Point for Gourmet Warming Drawer 食物保溫櫃接線位	-	-	-	-	-	-	-	-	-	-	-	-	1	-	-	-	-	-	-	-	-	-	-	-	-	-	1							
	TV/FM Outlet 電視/電台插座	2	2	2	2	2	2	2	2	2	2	2	2	2	2	2	2	2	2	2	2	2	2	2	2	2	2	2	2						
Telephone Outlet 電話插座	2	2	2	2	2	2	2	2	2	2	2	2	2	2	2	2	2	2	2	2	2	2	2	2	2	2	2	2							
Connection point for Indoor Air-Conditioner Unit 室內空調機接線位	1	1	1	1	1	1	1	1	1	1	1	1	3	1	1	1	1	2	1	1	1	1	2	1	1	1	2								
Master Bedroom 主人睡房	Lighting Switch 燈掣	4	4	2	3	-	3	4	4	2	3	-	3	4	2	3	-	3	3	4	1	4	2	4	4	1	4								
	Lighting Point 燈位	2	2	1	1	-	1	2	2	1	1	-	1	1	1	1	-	1	2	1	1	2	1	2	1	1	1								
	Switch for Exhaust Fan 抽氣扇開關	1	1	-	1	-	1	1	1	-	1	-	1	1	-	1	-	1	1	1	-	1	-	1	1	-	1								
	Switch for Electric Water Heater 電熱水爐開關	-	-	-	1	-	1	-	-	-	1	-	1	-	-	1	-	1	-	-	-	-	-	-	-	-	-	-							
	13A Single Socket Outlet 13A單位電插座	-	-	-	-	-	-	-	-	-	-	-	-	1	-	-	-	-	-	-	-	-	-	-	-	-	-	1							
	13A Twin Socket Outlet 13A雙位電插座	2	2	2	2	-	2	2	2	2	2	-	2	3	2	2	-	2	2	2	2	2	2	2	2	2	2	3							
	TV/FM Outlet 電視/電台插座	1	1	1	1	-	1	1	1	1	1	-	1	2	1	1	-	1	1	1	1	1	1	1	1	1	1	2							
Telephone Outlet 電話插座	1	1	1	1	-	1	1	1	1	1	-	1	2	1	1	-	1	1	1	1	1	1	1	1	1	1	2								
Connection point for Indoor Air-Conditioner Unit 室內空調機接線位	1	1	1	1	-	1	1	1	1	1	-	1	1	1	1	-	1	1	1	1	1	1	1	1	1	1	1								

Remarks :

- “1, 2,” denotes the quantity of such provision(s) provided in the residential property.
- “-” denotes “not applicable”.
- The quantity of the lighting switch shown in the schedule denotes the quantity of switch on/off button(s).
- 13/F, 14/F, 24/F, 34/F, 44/F and 54/F are omitted.

備註 :

- “1, 2,” 表示提供於該住宅物業內的裝置數量。
- “-” 代表 “不適用”。
- 說明表所顯示的燈掣數量是表示燈掣開/關的數量。
- 不設13樓、14樓、24樓、34樓、44樓及54樓。

Fittings, finishes and appliances

裝置、裝修物料及設備

Schedule of Mechanical & Electrical Provisions of Residential Properties 住宅物業機電裝置數量說明表

Location 位置	Description 描述	Tower 7 (7A) 第7座 (7A)												Tower 7 (7B) 第7座 (7B)																					
		7/F 7樓						8/F-12/F, 15/F-16/F, 18/F-23/F, 25/F-33/F, 35/F-39/F, 41/F-43/F, 45/F-53/F & 55/F-61/F 8樓至12樓, 15樓至16樓, 18樓至23樓, 25樓至33樓, 35樓至39樓, 41樓至43樓, 45樓至53樓及55樓至61樓						62/F 62樓						7/F 7樓						8/F-12/F, 15/F-16/F, 18/F-23/F, 25/F-33/F, 35/F-39/F, 41/F-43/F, 45/F-53/F & 55/F-61/F 8樓至12樓, 15樓至16樓, 18樓至23樓, 25樓至33樓, 35樓至39樓, 41樓至43樓, 45樓至53樓及55樓至61樓						62/F 62樓			
		A	B	C	D	E	F	A	B	C	D	E	F	A	C	D	E	F	A	B	C	D	E	A	B	C	D	E	A	B	C	D			
Bedroom 1 睡房 1	Lighting Switch 燈掣	1	1	1	-	-	-	1	1	1	-	-	-	3	1	-	-	-	1	1	-	1	1	1	1	-	1	1	1	1	-	1			
	Lighting Point 燈位	1	1	1	-	-	-	1	1	1	-	-	-	2	1	-	-	-	1	1	-	1	1	1	1	-	1	1	1	1	-	1			
	Switch for Exhaust Fan 抽氣扇開關	-	-	-	-	-	-	-	-	-	-	-	-	1	-	-	-	-	-	-	-	-	-	-	-	-	-	-	-	-	-	-			
	13A Single Socket Outlet 13A單位電插座	1	1	1	-	-	-	1	1	1	-	-	-	-	1	-	-	-	1	1	-	1	1	1	1	-	1	1	1	1	-	1			
	13A Twin Socket Outlet 13A雙位電插座	1	1	1	-	-	-	1	1	1	-	-	-	2	1	-	-	-	1	1	-	1	1	1	1	-	1	1	1	1	-	1			
	TV/FM Outlet 電視/電台插座	1	1	1	-	-	-	1	1	1	-	-	-	2	1	-	-	-	1	1	-	1	1	1	1	-	1	1	1	1	-	1			
	Telephone Outlet 電話插座	1	1	1	-	-	-	1	1	1	-	-	-	2	1	-	-	-	1	1	-	1	1	1	1	-	1	1	1	1	-	1			
Connection point for Indoor Air-Conditioner Unit 室內空調機接線位	1	1	1	-	-	-	1	1	1	-	-	-	1	1	-	-	-	1	1	-	1	1	1	1	-	1	1	1	1	-	1				
Bedroom 2 睡房 2	Lighting Switch 燈掣	1	1	-	-	-	-	1	1	-	-	-	-	1	-	-	-	-	1	-	-	1	-	1	-	-	1	-	1	-	-	1			
	Lighting Point 燈位	1	1	-	-	-	-	1	1	-	-	-	-	1	-	-	-	-	1	-	-	1	-	1	-	-	1	-	1	-	-	1			
	13A Single Socket Outlet 13A單位電插座	1	1	-	-	-	-	1	1	-	-	-	-	1	-	-	-	-	1	-	-	1	-	1	-	-	1	-	1	-	-	1			
	13A Twin Socket Outlet 13A雙位電插座	1	1	-	-	-	-	1	1	-	-	-	-	1	-	-	-	-	1	-	-	1	-	1	-	-	1	-	1	-	-	1			
	TV/FM Outlet 電視/電台插座	1	1	-	-	-	-	1	1	-	-	-	-	1	-	-	-	-	1	-	-	1	-	1	-	-	1	-	1	-	-	1			
	Telephone Outlet 電話插座	1	1	-	-	-	-	1	1	-	-	-	-	1	-	-	-	-	1	-	-	1	-	1	-	-	1	-	1	-	-	1			
	Connection point for Indoor Air-Conditioner Unit 室內空調機接線位	1	1	-	-	-	-	1	1	-	-	-	-	1	-	-	-	-	1	-	-	1	-	1	-	-	1	-	1	-	-	1			
Bedroom 3 睡房 3	Lighting Switch 燈掣	-	-	-	-	-	-	-	-	-	-	-	-	1	-	-	-	-	-	-	-	-	-	-	-	-	-	-	-	-	-	-			
	Lighting Point 燈位	-	-	-	-	-	-	-	-	-	-	-	-	1	-	-	-	-	-	-	-	-	-	-	-	-	-	-	-	-	-	-			
	13A Single Socket Outlet 13A單位電插座	-	-	-	-	-	-	-	-	-	-	-	-	1	-	-	-	-	-	-	-	-	-	-	-	-	-	-	-	-	-	-			
	13A Twin Socket Outlet 13A雙位電插座	-	-	-	-	-	-	-	-	-	-	-	-	1	-	-	-	-	-	-	-	-	-	-	-	-	-	-	-	-	-	-			
	TV/FM Outlet 電視/電台插座	-	-	-	-	-	-	-	-	-	-	-	-	1	-	-	-	-	-	-	-	-	-	-	-	-	-	-	-	-	-	-			
	Telephone Outlet 電話插座	-	-	-	-	-	-	-	-	-	-	-	-	1	-	-	-	-	-	-	-	-	-	-	-	-	-	-	-	-	-	-			
	Connection point for Indoor Air-Conditioner Unit 室內空調機接線位	-	-	-	-	-	-	-	-	-	-	-	-	1	-	-	-	-	-	-	-	-	-	-	-	-	-	-	-	-	-	-			

Remarks :

- “1, 2,” denotes the quantity of such provision(s) provided in the residential property.
- “-” denotes “not applicable”.
- The quantity of the lighting switch shown in the schedule denotes the quantity of switch on/off button(s).
- 13/F, 14/F, 24/F, 34/F, 44/F and 54/F are omitted.

備註 :

- “1, 2,” 表示提供於該住宅物業內的裝置數量。
- “-” 代表 “不適用”。
- 說明表所顯示的燈掣數量是表示燈掣開/關的數量。
- 不設13樓、14樓、24樓、34樓、44樓及54樓。

Fittings, finishes and appliances

裝置、裝修物料及設備

Schedule of Mechanical & Electrical Provisions of Residential Properties 住宅物業機電裝置數量說明表

Location 位置	Description 描述	Tower 7 (7A) 第7座 (7A)												Tower 7 (7B) 第7座 (7B)																					
		7/F 7樓						8/F-12/F, 15/F-16/F, 18/F-23/F, 25/F-33/F, 35/F-39/F, 41/F-43/F, 45/F-53/F & 55/F-61/F 8樓至12樓, 15樓至16樓, 18樓至23樓, 25樓至33樓, 35樓至39樓, 41樓至43樓, 45樓至53樓及55樓至61樓						62/F 62樓						7/F 7樓						8/F-12/F, 15/F-16/F, 18/F-23/F, 25/F-33/F, 35/F-39/F, 41/F-43/F, 45/F-53/F & 55/F-61/F 8樓至12樓, 15樓至16樓, 18樓至23樓, 25樓至33樓, 35樓至39樓, 41樓至43樓, 45樓至53樓及55樓至61樓						62/F 62樓			
		A	B	C	D	E	F	A	B	C	D	E	F	A	C	D	E	F	A	B	C	D	E	A	B	C	D	E	A	B	C	D			
Bathroom 浴室	Lighting Point 燈位	-	-	3	3	3	3	-	-	3	3	3	3	-	3	3	3	3	-	-	3	-	3	-	-	3	-	3	-	-	3	-			
	13A Twin Socket Outlet 13A雙位電插座	-	-	1	1	1	1	-	-	1	1	1	1	-	1	1	1	1	-	-	1	-	1	-	-	1	-	1	-	-	1	-			
	Power Bar 多功能插蘇板	-	-	1	1	1	1	-	-	1	1	1	1	-	1	1	1	1	-	-	1	-	1	-	-	1	-	1	-	-	1	-			
	Wireless charger 無線充電座	-	-	1	1	1	1	-	-	1	1	1	1	-	1	1	1	1	-	-	1	-	1	-	-	1	-	1	-	-	1	-			
	13A Twin Socket Outlet for Built-in Washer Dryer and Other Purpose 13A 雙位電插座供嵌入式洗衣乾衣機及其他用途	-	-	1	1	1	1	-	-	1	1	1	1	-	1	1	1	1	-	-	1	-	1	-	-	1	-	1	-	-	1	-			
	Connection Point for Other Purpose 接線位供其他用途	-	-	1	1	1	1	-	-	1	1	1	1	-	1	1	1	1	-	-	1	-	1	-	-	1	-	1	-	-	1	-			
	Connection Point for Mirror Cabinet Lighting 鏡櫃燈接線位	-	-	1	1	1	1	-	-	1	1	1	1	-	1	1	1	1	-	-	1	-	1	-	-	1	-	1	-	-	1	-			
	Connection Point for Lighting at Roof 接線位供天台燈	-	-	-	-	-	-	-	-	-	-	-	-	-	1	1	-	1	-	-	-	-	-	-	-	-	-	-	-	-	-	-			
	Connection Point For Exhaust Fan 抽氣扇接線位	-	-	1	1	1	1	-	-	1	1	1	1	-	1	1	1	1	-	-	1	-	1	-	-	1	-	1	-	-	1	-			
	Connection Point for Thermal Ventilator 浴室換氣暖風機接線位	-	-	1	1	1	1	-	-	1	1	1	1	-	1	1	1	1	-	-	1	-	1	-	-	1	-	1	-	-	1	-			
	Gas Water Heater Remote Controller 煤氣熱水爐遙控器	-	-	1	-	-	-	-	-	1	-	-	-	-	1	-	-	-	-	-	-	-	1	-	-	-	-	1	-	-	-	-			
	Connection Point for Gas Water Heater 煤氣熱水爐接線位	-	-	1	-	-	-	-	-	1	-	-	-	-	1	-	-	-	-	-	-	-	-	-	-	-	-	-	-	-	-	-			
	Connection Point for Electric Water heater 電熱水爐接線位	-	-	-	1	-	1	-	-	-	1	-	1	-	-	1	-	1	-	-	1	-	-	-	-	1	-	-	-	-	1	-			
	Electric Water Heater Temperature Control 電熱水爐溫度控制	-	-	-	1	1	1	-	-	-	1	1	1	-	-	1	1	1	-	-	1	-	-	-	-	1	-	-	-	-	1	-			
Built-in Washer Dryer Connection Point (Water Inlet) 嵌入式洗衣乾衣機接駁點 (來水位)	-	-	1	1	1	1	-	-	1	1	1	1	-	1	1	1	1	-	-	1	-	1	-	-	1	-	1	-	-	1	-				
Built-in Washer Dryer Connection Point (Water Outlet) 嵌入式洗衣乾衣機接駁點 (去水位)	-	-	1	1	1	1	-	-	1	1	1	1	-	1	1	1	1	-	-	1	-	1	-	-	1	-	1	-	-	1	-				
Bathroom 1 浴室 1	Lighting Point 燈位	3	3	-	-	-	-	3	3	-	-	-	-	5	-	-	-	-	3	3	-	4	-	3	3	-	4	-	3	3	-	5			
	13A Twin Socket Outlet 13A雙位電插座	1	1	-	-	-	-	1	1	-	-	-	-	2	-	-	-	-	1	1	-	1	-	1	1	-	1	-	1	1	-	2			
	Power Bar 多功能插蘇板	1	1	-	-	-	-	1	1	-	-	-	-	1	-	-	-	-	1	1	-	1	-	1	1	-	1	-	1	1	-	1			
	Wireless charger 無線充電座	1	1	-	-	-	-	1	1	-	-	-	-	1	-	-	-	-	1	1	-	1	-	1	1	-	1	-	1	1	-	1			
	Connection Point for Other Purpose 接線位供其他用途	1	1	-	-	-	-	1	1	-	-	-	-	1	-	-	-	-	1	1	-	1	-	1	1	-	1	-	1	1	-	1			
	Connection Point for Mirror Cabinet Lighting 鏡櫃燈接線位	1	1	-	-	-	-	1	1	-	-	-	-	1	-	-	-	-	1	1	-	1	-	1	1	-	1	-	1	1	-	1			
	Connection Point for Lighting at Flat Roof 接線位供平台燈	1	1	-	-	-	-	-	-	-	-	-	-	-	-	-	-	-	-	1	-	1	-	-	-	-	-	-	-	-	-	-			
	Connection Point for Lighting at Roof 接線位供天台燈	-	-	-	-	-	-	-	-	-	-	-	-	2	-	-	-	-	-	-	-	-	-	-	-	-	-	-	1	1	-	1			
	Connection Point For Exhaust Fan 抽氣扇接線位	1	1	-	-	-	-	1	1	-	-	-	-	1	-	-	-	-	1	1	-	1	-	1	1	-	1	-	1	1	-	1			
	Connection Point for Thermal Ventilator 浴室換氣暖風機接線位	1	1	-	-	-	-	1	1	-	-	-	-	1	-	-	-	-	1	1	-	1	-	1	1	-	1	-	1	1	-	1			
	Gas Water Heater Remote Controller 煤氣熱水爐遙控器	1	1	-	-	-	-	1	1	-	-	-	-	1	-	-	-	-	1	1	-	1	-	1	1	-	1	-	1	1	-	1			
	Connection Point for Gas Water Heater 煤氣熱水爐接線位	-	-	-	-	-	-	-	-	-	-	-	-	2	-	-	-	-	-	-	-	-	-	-	-	-	-	-	-	-	-	2			

Remarks :

- "1, 2," denotes the quantity of such provision(s) provided in the residential property.
- "-" denotes "not applicable".
- The quantity of the lighting switch shown in the schedule denotes the quantity of switch on/off button(s).
- 13/F, 14/F, 24/F, 34/F, 44/F and 54/F are omitted.

備註 :

- "1, 2," 表示提供於該住宅物業內的裝置數量。
- "-" 代表 "不適用"。
- 說明表所顯示的燈掣數量是表示燈掣開/關的數量。
- 不設13樓、14樓、24樓、34樓、44樓及54樓。

Fittings, finishes and appliances

裝置、裝修物料及設備

Schedule of Mechanical & Electrical Provisions of Residential Properties 住宅物業機電裝置數量說明表

Location 位置	Description 描述	Tower 7 (7A) 第7座 (7A)												Tower 7 (7B) 第7座 (7B)																					
		7/F 7樓						8/F-12/F, 15/F-16/F, 18/F-23/F, 25/F-33/F, 35/F-39/F, 41/F-43/F, 45/F-53/F & 55/F-61/F 8樓至12樓, 15樓至16樓, 18樓至23樓, 25樓至33樓, 35樓至39樓, 41樓至43樓, 45樓至53樓及55樓至61樓						62/F 62樓						7/F 7樓						8/F-12/F, 15/F-16/F, 18/F-23/F, 25/F-33/F, 35/F-39/F, 41/F-43/F, 45/F-53/F & 55/F-61/F 8樓至12樓, 15樓至16樓, 18樓至23樓, 25樓至33樓, 35樓至39樓, 41樓至43樓, 45樓至53樓及55樓至61樓						62/F 62樓			
		A	B	C	D	E	F	A	B	C	D	E	F	A	C	D	E	F	A	B	C	D	E	A	B	C	D	E	A	B	C	D			
Bathroom 2 浴室 2	Lighting Point 燈位	3	3	-	-	-	-	3	3	-	-	-	-	3	-	-	-	-	3	3	-	3	-	3	3	-	3	-	3	3	-	3			
	13A Twin Socket Outlet 13A雙位電插座	1	1	-	-	-	-	1	1	-	-	-	-	1	-	-	-	-	1	1	-	1	-	1	1	-	1	-	1	1	-	1			
	Power Bar 多功能插蘇板	1	1	-	-	-	-	1	1	-	-	-	-	1	-	-	-	-	1	1	-	1	-	1	1	-	1	-	1	1	-	1			
	Wireless charger 無線充電座	1	1	-	-	-	-	1	1	-	-	-	-	1	-	-	-	-	1	1	-	1	-	1	1	-	1	-	1	1	-	1			
	13A Twin Socket Outlet for Built-in Washer Dryer and Other Purpose 13A 雙位電插座供嵌入式洗衣乾衣機及其他用途	1	1	-	-	-	-	1	1	-	-	-	-	-	-	-	-	-	1	1	-	1	-	1	1	-	1	-	1	1	-	-			
	Connection Point for Other Purpose 接線位供其他用途	1	1	-	-	-	-	1	1	-	-	-	-	1	-	-	-	-	1	1	-	1	-	1	1	-	1	-	1	1	-	1			
	Connection Point for Mirror Cabinet Lighting 鏡櫃燈接線位	1	1	-	-	-	-	1	1	-	-	-	-	1	-	-	-	-	1	1	-	1	-	1	1	-	1	-	1	1	-	1			
	Connection Point for Lighting at Flat Roof 接線位供平台燈	-	-	-	-	-	-	-	-	-	-	-	-	-	-	-	-	-	1	-	-	1	-	-	-	-	-	-	-	-	-	-			
	Connection Point for Lighting at Roof 接線位供天台燈	-	-	-	-	-	-	-	-	-	-	-	-	1	-	-	-	-	-	-	-	-	-	-	-	-	-	-	1	-	-	1			
	Connection Point For Exhaust Fan 抽氣扇接線位	1	1	-	-	-	-	1	1	-	-	-	-	1	-	-	-	-	1	1	-	1	-	1	1	-	1	-	1	1	-	1			
	Connection Point for Thermal Ventilator 浴室換氣暖風機接線位	1	1	-	-	-	-	1	1	-	-	-	-	1	-	-	-	-	1	1	-	1	-	1	1	-	1	-	1	1	-	1			
	Gas Water Heater Remote Controller 煤氣熱水爐遙控器	1	1	-	-	-	-	1	1	-	-	-	-	1	-	-	-	-	1	1	-	1	-	1	1	-	1	-	1	1	-	1			
	Built-in Washer Dryer Connection Point (Water Inlet) 嵌入式洗衣乾衣機接駁點(來水位)	1	1	-	-	-	-	1	1	-	-	-	-	-	-	-	-	-	1	1	-	1	-	1	1	-	1	-	1	1	-	-			
Built-in Washer Dryer Connection Point (Water Outlet) 嵌入式洗衣乾衣機接駁點(去水位)	1	1	-	-	-	-	1	1	-	-	-	-	-	-	-	-	-	1	1	-	1	-	1	1	-	1	-	1	1	-	-				
Bathroom 3 浴室 3	Lighting Point 燈位	-	-	-	-	-	-	-	-	-	-	-	3	-	-	-	-	-	-	-	-	-	-	-	-	-	-	-	-	-	-				
	13A Twin Socket Outlet 13A雙位電插座	-	-	-	-	-	-	-	-	-	-	-	1	-	-	-	-	-	-	-	-	-	-	-	-	-	-	-	-	-	-				
	Power Bar 多功能插蘇板	-	-	-	-	-	-	-	-	-	-	-	1	-	-	-	-	-	-	-	-	-	-	-	-	-	-	-	-	-	-				
	Wireless charger 無線充電座	-	-	-	-	-	-	-	-	-	-	-	1	-	-	-	-	-	-	-	-	-	-	-	-	-	-	-	-	-	-				
	Connection Point for Other Purpose 接線位供其他用途	-	-	-	-	-	-	-	-	-	-	-	1	-	-	-	-	-	-	-	-	-	-	-	-	-	-	-	-	-	-				
	Connection Point for Mirror Cabinet Lighting 鏡櫃燈接線位	-	-	-	-	-	-	-	-	-	-	-	1	-	-	-	-	-	-	-	-	-	-	-	-	-	-	-	-	-	-				
	Connection Point for Lighting at Roof 接線位供天台燈	-	-	-	-	-	-	-	-	-	-	-	1	-	-	-	-	-	-	-	-	-	-	-	-	-	-	-	-	-	-				
	Connection Point For Exhaust Fan 抽氣扇接線位	-	-	-	-	-	-	-	-	-	-	-	1	-	-	-	-	-	-	-	-	-	-	-	-	-	-	-	-	-	-				
	Connection Point for Thermal Ventilator 浴室換氣暖風機接線位	-	-	-	-	-	-	-	-	-	-	-	1	-	-	-	-	-	-	-	-	-	-	-	-	-	-	-	-	-	-				
Gas Water Heater Remote Controller 煤氣熱水爐遙控器	-	-	-	-	-	-	-	-	-	-	-	1	-	-	-	-	-	-	-	-	-	-	-	-	-	-	-	-	-	-					

Remarks :

- “1, 2,” denotes the quantity of such provision(s) provided in the residential property.
- “-” denotes “not applicable”.
- The quantity of the lighting switch shown in the schedule denotes the quantity of switch on/off button(s).
- 13/F, 14/F, 24/F, 34/F, 44/F and 54/F are omitted.

備註 :

- “1, 2,” 表示提供於該住宅物業內的裝置數量。
- “-” 代表 “不適用”。
- 說明表所顯示的燈掣數量是表示燈掣開/關的數量。
- 不設13樓、14樓、24樓、34樓、44樓及54樓。

Fittings, finishes and appliances

裝置、裝修物料及設備

Schedule of Mechanical & Electrical Provisions of Residential Properties 住宅物業機電裝置數量說明表

Location 位置	Description 描述	Tower 7 (7A) 第7座 (7A)												Tower 7 (7B) 第7座 (7B)																					
		7/F 7樓						8/F-12/F, 15/F-16/F, 18/F-23/F, 25/F-33/F, 35/F-39/F, 41/F-43/F, 45/F-53/F & 55/F-61/F 8樓至12樓, 15樓至16樓, 18樓至23樓, 25樓至33樓, 35樓至39樓, 41樓至43樓, 45樓至53樓及55樓至61樓						62/F 62樓						7/F 7樓						8/F-12/F, 15/F-16/F, 18/F-23/F, 25/F-33/F, 35/F-39/F, 41/F-43/F, 45/F-53/F & 55/F-61/F 8樓至12樓, 15樓至16樓, 18樓至23樓, 25樓至33樓, 35樓至39樓, 41樓至43樓, 45樓至53樓及55樓至61樓						62/F 62樓			
		A	B	C	D	E	F	A	B	C	D	E	F	A	C	D	E	F	A	B	C	D	E	A	B	C	D	E	A	B	C	D			
Kitchen 廚房	Lighting Switch 燈掣	-	-	-	-	-	-	-	-	-	-	-	-	-	-	-	-	-	-	-	-	-	-	-	-	-	-	-	-	-	-	-	-	-	
	Lighting Point 燈位	2	2	-	-	-	-	2	2	-	-	-	-	3	-	-	-	-	2	2	-	2	2	2	2	2	2	2	2	2	2	2	2	2	4
	Door Bell 門鈴	1	1	-	-	-	-	1	1	-	-	-	-	-	-	-	-	1	1	-	1	1	1	1	1	1	1	1	1	1	1	1	1	-	-
	13A Twin Socket Outlet with USB 13A雙位電插座配USB插座	2	2	-	-	-	-	2	2	-	-	-	-	3	-	-	-	-	2	2	-	2	2	2	2	2	2	2	2	2	2	2	2	2	3
	Connection Point for Built-in 2 Door Refrigerator, Bottom Freezer 嵌入式雙門雪櫃接線位	1	1	-	-	-	-	1	1	-	-	-	-	-	-	-	-	1	1	-	1	1	1	1	1	1	1	1	1	1	1	1	1	-	-
	Connection Point for Built-in Fridge-Freezer 嵌入式雪櫃連冰箱接線位	-	-	-	-	-	-	-	-	-	-	-	-	1	-	-	-	-	-	-	-	-	-	-	-	-	-	-	-	-	-	-	-	1	
	Connection Point for Built-in Wine Storage 嵌入式酒櫃接線位	-	-	-	-	-	-	-	-	-	-	-	-	-	-	-	-	-	-	-	-	-	-	-	-	-	-	-	-	-	-	-	-	-	
	Connection Point for Exhaust Fan 抽氣扇接線位	1	1	-	-	-	-	1	1	-	-	-	-	2	-	-	-	-	1	1	-	1	1	1	1	1	1	1	1	1	1	1	1	1	1
	Connection Point for Kitchen Cabinet Lighting 廚房櫃燈接線位	1	1	-	-	-	-	1	1	-	-	-	-	1	-	-	-	-	1	1	-	1	1	1	1	1	1	1	1	1	1	1	1	1	1
	Connection Point for Lighting at Flat Roof 接線位供天台燈	1	1	-	-	-	-	-	-	-	-	-	-	-	-	-	-	1	1	-	-	-	-	-	-	-	-	-	-	-	-	-	-	-	1
	Connection Point for Lighting at Roof 接線位供天台燈	-	-	-	-	-	-	-	-	-	-	-	-	1	-	-	-	-	-	-	-	-	-	-	-	-	-	-	-	-	-	1	1	-	2
	Connection Point for Barbecue Grill 燒烤爐接線位	-	-	-	-	-	-	-	-	-	-	-	-	1	-	-	-	-	-	-	-	-	-	-	-	-	-	-	-	-	-	-	-	-	1
	Connection Point for Built-in Oven with Microwave 嵌入式微波焗爐接線位	-	-	-	-	-	-	-	-	-	-	-	-	-	-	-	-	1	1	-	-	1	1	1	1	1	1	1	1	1	1	1	1	1	-
	Connection Point for Oven with Microwave 微波焗爐接線位	1	1	-	-	-	-	1	1	-	-	-	-	1	-	-	-	-	-	-	-	1	-	-	-	-	-	-	-	-	-	-	-	-	1
	Connection Point for Steam Oven 蒸爐接線位	-	-	-	-	-	-	-	-	-	-	-	-	1	-	-	-	-	-	-	-	-	-	-	-	-	-	-	-	-	-	-	-	-	1
	Connection Point for Gas Water Heater 煤氣熱水爐接線位	1	1	-	-	-	-	1	1	-	-	-	-	-	-	-	-	1	1	-	1	1	1	1	1	1	1	1	1	1	1	1	1	1	-
	Connection Point for Gas Hob 氣體煮食爐接線位	2	2	-	-	-	-	2	2	-	-	-	-	2	-	-	-	-	2	2	-	2	2	2	2	2	2	2	2	2	2	2	2	2	2
	Connection Point for 90cm Telescopic Hood 90厘米拉趟式抽油煙機接線位	1	1	-	-	-	-	1	1	-	-	-	-	-	-	-	-	1	1	-	1	1	1	1	1	1	1	1	1	1	1	1	1	1	-
	Connection Point for Cooker Hood 抽油煙機接線位	-	-	-	-	-	-	-	-	-	-	-	-	1	-	-	-	-	-	-	-	-	-	-	-	-	-	-	-	-	-	-	-	-	1
	Connection Point for Indoor Air-Conditioner Unit 室內空調機接線位	-	-	-	-	-	-	-	-	-	-	-	-	1	-	-	-	-	-	-	-	-	-	-	-	-	-	-	-	-	-	-	-	-	1
Miniature Circuit Breakers Board 總電掣箱	1	1	-	-	-	-	1	1	-	-	-	-	-	-	-	-	1	1	-	1	1	1	1	1	1	1	1	1	1	1	1	1	1	-	

Remarks :

- “1, 2,” denotes the quantity of such provision(s) provided in the residential property.
- “-” denotes “not applicable”.
- The quantity of the lighting switch shown in the schedule denotes the quantity of switch on/off button(s).
- 13/F, 14/F, 24/F, 34/F, 44/F and 54/F are omitted.

備註 :

- “1, 2,” 表示提供於該住宅物業內的裝置數量。
- “-” 代表 “不適用”。
- 說明表所顯示的燈掣數量是表示燈掣開/關的數量。
- 不設13樓、14樓、24樓、34樓、44樓及54樓。

Fittings, finishes and appliances

裝置、裝修物料及設備

Schedule of Mechanical & Electrical Provisions of Residential Properties 住宅物業機電裝置數量說明表

Location 位置	Description 描述	Tower 7 (7A) 第7座 (7A)												Tower 7 (7B) 第7座 (7B)																					
		7/F 7樓						8/F-12/F, 15/F-16/F, 18/F-23/F, 25/F-33/F, 35/F-39/F, 41/F-43/F, 45/F-53/F & 55/F-61/F 8樓至12樓, 15樓至16樓, 18樓至23樓, 25樓至33樓, 35樓至39樓, 41樓至43樓, 45樓至53樓及55樓至61樓						62/F 62樓						7/F 7樓						8/F-12/F, 15/F-16/F, 18/F-23/F, 25/F-33/F, 35/F-39/F, 41/F-43/F, 45/F-53/F & 55/F-61/F 8樓至12樓, 15樓至16樓, 18樓至23樓, 25樓至33樓, 35樓至39樓, 41樓至43樓, 45樓至53樓及55樓至61樓						62/F 62樓			
		A	B	C	D	E	F	A	B	C	D	E	F	A	C	D	E	F	A	B	C	D	E	A	B	C	D	E	A	B	C	D			
Open Kitchen 開放式廚房	Lighting Point 燈位	-	-	1	-	1	-	-	-	1	-	1	-	-	1	-	1	-	-	1	-	-	-	-	1	-	-	-	1	-					
	Door Bell 門鈴	-	-	1	1	1	1	-	-	1	1	1	1	-	1	1	1	1	-	-	1	-	-	-	1	-	-	-	1	-					
	13A Twin Socket Outlet with USB 13A雙位電插座配USB插座	-	-	1	1	1	1	-	-	1	1	1	1	-	1	1	1	1	-	-	1	-	-	-	1	-	-	-	1	-					
	Connection Point for Built-in 2 Door Refrigerator, Bottom Freezer 嵌入式雙門雪櫃接線位	-	-	1	-	-	-	-	-	1	-	-	-	-	1	-	-	-	-	-	-	-	-	-	-	-	-	-	-	-					
	Connection Point for Built-in 1 Door Refrigerator, Top Freezer 嵌入式單門雪櫃接線位	-	-	-	1	-	1	-	-	-	1	-	1	-	-	1	-	1	-	-	1	-	-	-	1	-	-	-	1	-					
	Connection Point for Built-in Undercounter Refrigerator 嵌入式台下雪櫃接線位	-	-	-	-	1	-	-	-	-	-	1	-	-	-	-	1	-	-	-	-	-	-	-	-	-	-	-	-	-					
	Connection Point for Kitchen Cabinet Lighting 廚房櫃燈接線位	-	-	1	1	-	1	-	-	1	1	-	1	-	1	1	-	1	-	-	1	-	-	-	1	-	-	-	1	-					
	Connection Point for Lighting at Flat Roof 接線位供平台燈	-	-	-	1	-	1	-	-	-	-	-	-	-	-	-	-	-	-	-	1	-	-	-	-	-	-	-	-	-					
	Connection Point for Lighting at Roof 接線位供天台燈	-	-	-	-	-	-	-	-	-	-	-	-	-	-	-	-	-	-	-	-	-	-	-	-	-	-	-	-	-					
	Connection Point for Domino 2-zone Induction Hob 嵌入式雙頭電磁爐接線位	-	-	-	1	1	1	-	-	-	1	1	1	-	-	1	1	1	-	-	1	-	-	-	1	-	-	-	1	-					
	Connection Point for FlexInduction Plus Hob 60cm 嵌入式60厘米FlexInduction電磁爐接線位	-	-	1	-	-	-	-	-	1	-	-	-	-	1	-	-	-	-	-	-	-	-	-	-	-	-	-	-	-					
	Connection Point for Built-in Oven with Microwave 嵌入式微波焗爐接線位	-	-	1	1	-	1	-	-	1	1	-	1	-	1	1	-	1	-	-	1	-	-	-	1	-	-	-	1	-					
	13A Single Socket Outlet for Built-In Microwave with Grill 13A 單位電插座供嵌入式微波爐與烤架	-	-	-	-	1	-	-	-	-	-	1	-	-	-	-	1	-	-	-	-	-	-	-	-	-	-	-	-	-					
	Connection Point for 60cm Telescopic Hood 60厘米拉趟式抽油煙機接線位	-	-	1	1	1	1	-	-	1	1	1	1	-	1	1	1	1	-	-	1	-	-	-	1	-	-	-	1	-					
Miniature Circuit Breakers Board 總電掣箱	-	-	1	1	1	1	-	-	1	1	1	1	-	1	1	1	1	-	-	1	-	-	-	1	-	-	-	1	-						
Store 儲物房	Lighting Switch 燈掣	-	-	-	-	-	-	-	-	-	-	-	-	-	-	-	-	-	1	-	-	-	-	1	-	-	-	1	-						
	Lighting Point 燈位	-	-	-	-	-	-	-	-	-	-	-	-	-	-	-	-	-	1	-	-	-	-	1	-	-	-	1	-						
	13A Twin Socket Outlet 13A雙位電插座	-	-	-	-	-	-	-	-	-	-	-	-	-	-	-	-	-	1	-	-	-	-	1	-	-	-	1	-						
	Telephone Outlet 電話插座	-	-	-	-	-	-	-	-	-	-	-	-	-	-	-	-	-	1	-	-	-	-	1	-	-	-	1	-						
Utility Room 工作間	Connection Point for Indoor Air-Conditioner Unit 室內空調機接線位	-	-	-	-	-	-	-	-	-	-	-	-	-	-	-	-	1	-	-	-	-	1	-	-	-	1	-							
	Lighting Switch 燈掣	-	-	-	-	-	-	-	-	-	-	-	2	-	-	-	-	-	-	-	-	-	-	-	-	-	-	-	2						
	Lighting Point 燈位	-	-	-	-	-	-	-	-	-	-	-	1	-	-	-	-	-	-	-	-	-	-	-	-	-	-	-	1						
	13A Twin Socket Outlet 13A雙位電插座	-	-	-	-	-	-	-	-	-	-	-	1	-	-	-	-	-	-	-	-	-	-	-	-	-	-	-	1						

Remarks :

- "1, 2," denotes the quantity of such provision(s) provided in the residential property.
- "-" denotes "not applicable".
- The quantity of the lighting switch shown in the schedule denotes the quantity of switch on/off button(s).
- 13/F, 14/F, 24/F, 34/F, 44/F and 54/F are omitted.

備註 :

- "1, 2," 表示提供於該住宅物業內的裝置數量。
- "-" 代表 "不適用"。
- 說明表所顯示的燈掣數量是表示燈掣開/關的數量。
- 不設13樓、14樓、24樓、34樓、44樓及54樓。

Fittings, finishes and appliances 裝置、裝修物料及設備

Schedule of Mechanical & Electrical Provisions of Residential Properties 住宅物業機電裝置數量說明表

Location 位置	Description 描述	Tower 7 (7A) 第7座 (7A)												Tower 7 (7B) 第7座 (7B)																					
		7/F 7樓						8/F-12/F, 15/F-16/F, 18/F-23/F, 25/F-33/F, 35/F-39/F, 41/F-43/F, 45/F-53/F & 55/F-61/F 8樓至12樓, 15樓至16樓, 18樓至23樓, 25樓至33樓, 35樓至39樓, 41樓至43樓, 45樓至53樓及55樓至61樓						62/F 62樓						7/F 7樓						8/F-12/F, 15/F-16/F, 18/F-23/F, 25/F-33/F, 35/F-39/F, 41/F-43/F, 45/F-53/F & 55/F-61/F 8樓至12樓, 15樓至16樓, 18樓至23樓, 25樓至33樓, 35樓至39樓, 41樓至43樓, 45樓至53樓及55樓至61樓						62/F 62樓			
		A	B	C	D	E	F	A	B	C	D	E	F	A	C	D	E	F	A	B	C	D	E	A	B	C	D	E	A	B	C	D			
Utility Room 工作間	Connection Point for Freestanding Washing Machine 洗衣機接線位	-	-	-	-	-	-	-	-	-	-	-	1	-	-	-	-	-	-	-	-	-	-	-	-	-	-	-	-	1					
	Connection Point for Heat Pump Tumble Dryer 乾衣機接線位	-	-	-	-	-	-	-	-	-	-	-	1	-	-	-	-	-	-	-	-	-	-	-	-	-	-	-	-	1					
	Switch for Exhaust Fan 抽氣扇開關	-	-	-	-	-	-	-	-	-	-	-	1	-	-	-	-	-	-	-	-	-	-	-	-	-	-	-	-	1					
	Connection Point for Indoor Air-Conditioner Unit 室內空調機接線位	-	-	-	-	-	-	-	-	-	-	-	1	-	-	-	-	-	-	-	-	-	-	-	-	-	-	-	-	1					
	Miniature Circuit Breakers Board 總電掣箱	-	-	-	-	-	-	-	-	-	-	-	1	-	-	-	-	-	-	-	-	-	-	-	-	-	-	-	-	1					
	Gas Water Heater Remote Controller 煤氣熱水爐遙控器	-	-	-	-	-	-	-	-	-	-	-	1	-	-	-	-	-	-	-	-	-	-	-	-	-	-	-	-	1					
	Freestanding Washing Machine Connection Point (Water Inlet) 洗衣機接駁點 (來水位)	-	-	-	-	-	-	-	-	-	-	-	1	-	-	-	-	-	-	-	-	-	-	-	-	-	-	-	-	1					
	Freestanding Washing Machine Connection Point (Water Outlet) 洗衣機接駁點 (去水位)	-	-	-	-	-	-	-	-	-	-	-	1	-	-	-	-	-	-	-	-	-	-	-	-	-	-	-	-	1					
Freestanding Tumble Dryer Connection Point (Water Outlet) 乾衣機接駁點 (去水位)	-	-	-	-	-	-	-	-	-	-	-	1	-	-	-	-	-	-	-	-	-	-	-	-	-	-	-	-	1						
Toilet 洗手間	Lighting Point 燈位	-	-	-	-	-	-	-	-	-	-	1	-	-	-	-	-	-	-	-	-	-	-	-	-	-	-	-	1						
	Connection Point for Exhaust Fan 抽氣扇接線位	-	-	-	-	-	-	-	-	-	-	-	-	-	-	-	-	-	-	-	-	-	-	-	-	-	-	-	1						
Utility Platform 工作平台	Lighting Point 燈位	1	-	-	-	-	1	1	1	-	-	-	1	1	-	-	-	-	-	-	-	1	1	-	1	1	1	1	-	1					
Balcony 露台	Lighting Point 燈位	-	-	-	-	1	-	1	1	1	1	1	1	1	1	1	1	-	-	-	-	1	1	1	1	1	1	1	1	-					
	13A Single Watertight Socket Outlet 13A單位防水電插座	-	-	-	-	1	-	-	-	-	-	-	-	-	-	-	-	-	-	-	-	-	-	-	-	-	-	-	-	-					
Flat Roof 平台	Watertight Lighting Switch 防水燈掣	-	-	-	-	-	-	-	-	-	-	-	-	-	-	-	-	-	-	-	-	-	-	-	-	-	-	-	-	-					
	Lighting Point 燈位	1	2	2	1	-	1	-	-	-	-	-	-	-	-	-	-	1	2	1	2	2	-	-	-	-	-	-	-	1					
	13A Single Watertight Socket Outlet 13A單位防水電插座	1	1	1	1	-	1	-	-	-	-	-	-	-	-	-	-	1	1	1	1	1	-	-	-	-	-	-	-	-					
	Connection Point for Lighting Point 燈位接線位	-	-	-	-	-	-	-	-	-	-	-	-	-	-	-	-	-	-	-	-	-	-	-	-	-	-	-	-	-					
Air-Conditioner Platform 空調機平台	Isolator for Outdoor Air-Conditioner 室外空調機開關掣	3	3	2	1	1	1	3	3	2	1	1	1	6	2	1	1	1	3	2	1	3	2	3	2	1	3	2	3	6					
Roof 天台	Gas Point for Future Connection 煤氣供氣位作將來接駁用途	-	-	-	-	-	-	-	-	-	-	-	1	-	-	-	-	-	-	-	-	-	-	-	-	-	-	-	-	1					
	Watertight Lighting Switch 防水燈掣	-	-	-	-	-	-	-	-	-	-	-	1	1	1	1	1	-	-	-	-	-	-	-	-	-	1	1	1	1					
	13A Single Watertight Socket Outlet 13A單位防水電插座	-	-	-	-	-	-	-	-	-	-	-	4	1	1	1	1	-	-	-	-	-	-	-	-	-	1	1	1	4					
	Connection Point for Lighting Point 燈位接線位	-	-	-	-	-	-	-	-	-	-	-	1	1	1	1	1	-	-	-	-	-	-	-	-	-	1	1	1	1					

Remarks :

- "1, 2," denotes the quantity of such provision(s) provided in the residential property.
- "-" denotes "not applicable".
- The quantity of the lighting switch shown in the schedule denotes the quantity of switch on/off button(s).
- 13/F, 14/F, 24/F, 34/F, 44/F and 54/F are omitted.

備註 :

- "1, 2," 表示提供於該住宅物業內的裝置數量。
- "-" 代表 "不適用"。
- 說明表所顯示的燈掣數量是表示燈掣開/關的數量。
- 不設13樓、14樓、24樓、34樓、44樓及54樓。

Fittings, finishes and appliances

裝置、裝修物料及設備

Appliances Schedule 設備說明表

Location 位置	Appliance 設備	Brand Name 品牌名稱	Model No. 產品型號	Tower 5 (5A) 第5座 (5A)								Tower 5 (5B) 第5座 (5B)							
				7/F-12/F, 15/F-16/F, 18/F-23/F, 25/F-33/F, 35/F-39/F, 41/F-43/F, 45/F-53/F & 55/F-61/F 7樓至12樓, 15樓至16樓, 18樓至23樓, 25樓至33樓, 35樓至39樓, 41樓至43樓, 45樓至53樓及55樓至61樓				62/F 62樓				7/F-12/F, 15/F-16/F, 18/F-23/F, 25/F-33/F, 35/F-39/F, 41/F-43/F, 45/F-53/F & 55/F-61/F 7樓至12樓, 15樓至16樓, 18樓至23樓, 25樓至33樓, 35樓至39樓, 41樓至43樓, 45樓至53樓及55樓至61樓				62/F 62樓			
				A	B	C	D	E	A	B	D	E	A	B	C	D	A	C	D
Living Room/ Dining Room/ Master Bedroom/ Bedrooms 客廳 / 飯廳 / 主人睡房 / 睡房	Split-type Air-conditioner (Indoor Unit) 分體空調機 (室內機)	Daikin 大金	FTXS25EVMA8	-	-	-	-	-	-	-	-	-	-	-	-	-	-	-	-
			FTXS35EVMA8	✓	-	-	-	-	-	-	-	-	✓	✓	-	-	✓	-	-
			FTXS50FVMA8	-	-	-	-	-	✓	-	-	-	-	-	-	-	✓	-	-
			FTXS60FVMA8	✓	-	✓	✓	✓	✓	-	✓	✓	✓	✓	✓	✓	-	✓	✓
			FTXS71FVMA8	-	-	-	-	-	-	-	-	-	-	-	-	-	✓	-	-
			FTXS25EVMA	✓	✓	✓	✓	✓	-	✓	✓	✓	✓	✓	✓	✓	-	✓	✓
			FTXS35EVMA	-	✓	✓	✓	✓	✓	✓	✓	✓	-	-	✓	✓	✓	✓	✓
			FTXS50FVMA	-	-	-	-	-	-	-	-	-	-	-	-	-	-	-	-
			FTXS60FVMA	-	-	-	-	-	✓	-	-	-	-	-	-	-	-	-	-
			FTXS71FVMA	-	✓	-	-	-	-	✓	-	-	-	-	-	-	-	-	-
	Split-type Air-conditioner (Outdoor Unit) 分體空調機 (室外機)	Daikin 大金	RXS25EBVMA	-	-	-	-	-	-	-	-	-	-	-	-	-	-	-	
			RXS35EBVMA	✓	-	-	-	-	-	-	-	-	✓	✓	-	-	✓	-	-
			RXS50FVMA	-	-	-	-	-	✓	-	-	-	-	-	-	-	✓	-	-
			RXS60FVMA	✓	-	✓	✓	✓	✓	-	✓	✓	✓	✓	✓	✓	-	✓	✓
			RXS71FVMA	-	-	-	-	-	-	-	-	-	-	-	-	-	✓	-	-
			3MXS52EVMA	✓	✓	✓	✓	✓	-	✓	✓	✓	✓	✓	✓	✓	✓	✓	✓
			4MXS80EVMA	-	-	-	-	-	-	-	-	-	-	-	-	-	-	-	-
			4MXS100AA	-	✓	-	-	-	-	✓	-	-	-	-	-	-	-	-	-
4MXS115HV2C	-	-	-	-	-	✓	-	-	-	-	-	-	-	-	-	-			
Living Room/ Dining Room 客廳 / 飯廳	Built-in Fridge-freezer 嵌入式雪櫃連冰箱	Miele	KFNS 37232 iD	-	-	-	-	-	✓	-	-	-	-	-	✓	-	-		
	Mastercool Wine Conditioning Unit Mastercool 酒櫃	Miele	KWT 2611 Vi	-	-	-	-	-	✓	-	-	-	-	-	✓	-	-		
	Coffee Machine 咖啡機	Miele	CVA 7440	-	-	-	-	-	✓	-	-	-	-	-	✓	-	-		
	Gourmet Warming Drawer 食物保溫櫃	Miele	ESW 7010	-	-	-	-	-	✓	-	-	-	-	-	✓	-	-		

The vendor undertakes that if lifts or appliances of the specified brand name or model number are not installed in the Phase, lifts or appliances of comparable quality will be installed.

Remarks :

1. "✓" means such appliance(s) is / are provided and / or installed in the residential property.
2. "-" denotes "not applicable".
3. 13/F, 14/F, 24/F, 34/F, 44/F and 54/F are omitted.

賣方承諾如期數中沒有安裝指明的品牌名稱或產品型號的升降機或設備，便會安裝品質相若的升降機或設備。

備註：

1. "✓" 表示此設備於該住宅物業內提供及/或安裝。
2. "-" 代表 "不適用"。
3. 不設13樓、14樓、24樓、34樓、44樓及54樓。

Fittings, finishes and appliances

裝置、裝修物料及設備

Appliances Schedule 設備說明表

Location 位置	Appliance 設備	Brand Name 品牌名稱	Model No. 產品型號	Tower 5 (5A) 第5座 (5A)										Tower 5 (5B) 第5座 (5B)								
				7/F-12/F, 15/F-16/F, 18/F-23/F, 25/F-33/F, 35/F-39/F, 41/F-43/F, 45/F-53/F & 55/F-61/F 7樓至12樓, 15樓至16樓, 18樓至23樓, 25樓至33樓, 35樓至39樓, 41樓至43樓, 45樓至53樓及55樓至61樓					62/F 62樓					7/F-12/F, 15/F-16/F, 18/F-23/F, 25/F-33/F, 35/F-39/F, 41/F-43/F, 45/F-53/F & 55/F-61/F 7樓至12樓, 15樓至16樓, 18樓至23樓, 25樓至33樓, 35樓至39樓, 41樓至43樓, 45樓至53樓及55樓至61樓				62/F 62樓				
				A	B	C	D	E	A	B	D	E	A	B	C	D	A	C	D			
Store 儲物房	Split-type Air-conditioner (Indoor Unit) 分體空調機 (室內機)	Daikin 大金	FTXS25EVMA8	-	-	-	-	-	-	-	-	-	-	-	-	-	-	-	-	-		
			FTXS35EVMA8	-	-	-	-	-	-	-	-	-	-	-	-	-	-	-	-	-	-	
			FTXS50FVMA8	-	-	-	-	-	-	-	-	-	-	-	-	-	-	-	-	-	-	
			FTXS60FVMA8	-	-	-	-	-	-	-	-	-	-	-	-	-	-	-	-	-	-	
			FTXS71FVMA8	-	-	-	-	-	-	-	-	-	-	-	-	-	-	-	-	-	-	
			FTXS25EVMA	-	✓	-	-	-	-	✓	-	-	-	-	-	-	-	-	-	-	-	-
			FDXS25CVMA	-	-	-	-	-	-	-	-	-	-	-	-	-	-	-	-	-	-	-
			FTXS35EVMA	-	-	-	-	-	-	-	-	-	-	-	-	-	-	-	-	-	-	-
			FTXS50FVMA	-	-	-	-	-	-	-	-	-	-	-	-	-	-	-	-	-	-	-
			FTXS60FVMA	-	-	-	-	-	-	-	-	-	-	-	-	-	-	-	-	-	-	-
	FTXS71FVMA	-	-	-	-	-	-	-	-	-	-	-	-	-	-	-	-	-	-	-		
	Split-type Air-conditioner (Outdoor Unit) 分體空調機 (室外機)	Daikin 大金	RXS25EBVMA	-	-	-	-	-	-	-	-	-	-	-	-	-	-	-	-	-	-	
			RXS35EBVMA	-	-	-	-	-	-	-	-	-	-	-	-	-	-	-	-	-	-	
			RXS50FVMA	-	-	-	-	-	-	-	-	-	-	-	-	-	-	-	-	-	-	
			RXS60FVMA	-	-	-	-	-	-	-	-	-	-	-	-	-	-	-	-	-	-	
			RXS71FVMA	-	-	-	-	-	-	-	-	-	-	-	-	-	-	-	-	-	-	
			3MXS52EVMA	-	-	-	-	-	-	-	-	-	-	-	-	-	-	-	-	-	-	-
			4MXS80EVMA	-	-	-	-	-	-	-	-	-	-	-	-	-	-	-	-	-	-	-
4MXS100AA			-	✓	-	-	-	-	✓	-	-	-	-	-	-	-	-	-	-	-	-	
4MXS115HV2C	-	-	-	-	-	-	-	-	-	-	-	-	-	-	-	-	-	-	-			

The vendor undertakes that if lifts or appliances of the specified brand name or model number are not installed in the Phase, lifts or appliances of comparable quality will be installed.

Remarks :

1. "✓" means such appliance(s) is / are provided and / or installed in the residential property.
2. "-" denotes "not applicable".
3. 13/F, 14/F, 24/F, 34/F, 44/F and 54/F are omitted.

賣方承諾如期數中沒有安裝指明的品牌名稱或產品型號的升降機或設備，便會安裝品質相若的升降機或設備。

備註：

1. "✓" 表示此設備於該住宅物業內提供及/或安裝。
2. "-" 代表 "不適用"。
3. 不設13樓、14樓、24樓、34樓、44樓及54樓。

Fittings, finishes and appliances

裝置、裝修物料及設備

Appliances Schedule 設備說明表

Location 位置	Appliance 設備	Brand Name 品牌名稱	Model No. 產品型號	Tower 5 (5A) 第5座 (5A)										Tower 5 (5B) 第5座 (5B)								
				7/F-12/F, 15/F-16/F, 18/F-23/F, 25/F-33/F, 35/F-39/F, 41/F-43/F, 45/F-53/F & 55/F-61/F 7樓至12樓, 15樓至16樓, 18樓至23樓, 25樓至33樓, 35樓至39樓, 41樓至43樓, 45樓至53樓及55樓至61樓					62/F 62樓					7/F-12/F, 15/F-16/F, 18/F-23/F, 25/F-33/F, 35/F-39/F, 41/F-43/F, 45/F-53/F & 55/F-61/F 7樓至12樓, 15樓至16樓, 18樓至23樓, 25樓至33樓, 35樓至39樓, 41樓至43樓, 45樓至53樓及55樓至61樓					62/F 62樓			
				A	B	C	D	E	A	B	D	E	A	B	C	D	A	C	D			
Kitchen 廚房	Split-type Air-conditioner (Indoor Unit) 分體空調機 (室內機)	Daikin 大金	FTXS25EVMA8	-	-	-	-	-	-	-	-	-	-	-	-	-	-	-	-	-		
			FTXS35EVMA8	-	-	-	-	-	-	-	-	-	-	-	-	-	-	-	-	-	-	
			FTXS50FVMA8	-	-	-	-	-	-	-	-	-	-	-	-	-	-	-	-	-	-	
			FTXS60FVMA8	-	-	-	-	-	-	-	-	-	-	-	-	-	-	-	-	-	-	
			FTXS71FVMA8	-	-	-	-	-	-	-	-	-	-	-	-	-	-	-	-	-	-	
			FTXS25EVMA	-	-	-	-	-	-	-	-	-	-	-	-	-	-	-	-	-	-	-
			FDXS35CVMA	-	-	-	-	-	✓	-	-	-	-	-	-	-	-	✓	-	-	-	-
			FTXS35EVMA	-	-	-	-	-	-	-	-	-	-	-	-	-	-	-	-	-	-	-
			FTXS50FVMA	-	-	-	-	-	-	-	-	-	-	-	-	-	-	-	-	-	-	-
			FTXS60FVMA	-	-	-	-	-	-	-	-	-	-	-	-	-	-	-	-	-	-	-
			FTXS71FVMA	-	-	-	-	-	-	-	-	-	-	-	-	-	-	-	-	-	-	-
	Split-type Air-conditioner (Outdoor Unit) 分體空調機 (室外機)	Daikin 大金	RXS25EBVMA	-	-	-	-	-	-	-	-	-	-	-	-	-	-	-	-	-	-	
			RXS35EBVMA	-	-	-	-	-	-	-	-	-	-	-	-	-	-	-	-	-	-	
			RXS50FVMA	-	-	-	-	-	-	-	-	-	-	-	-	-	-	-	-	-	-	
			RXS60FVMA	-	-	-	-	-	-	-	-	-	-	-	-	-	-	-	-	-	-	
			RXS71FVMA	-	-	-	-	-	-	-	-	-	-	-	-	-	-	-	-	-	-	
			3MXS52EVMA	-	-	-	-	-	✓	-	-	-	-	-	-	-	-	✓	-	-	-	-
			4MXS80EVMA	-	-	-	-	-	-	-	-	-	-	-	-	-	-	-	-	-	-	-
			4MXS100AA	-	-	-	-	-	-	-	-	-	-	-	-	-	-	-	-	-	-	-
	4MXS115HV2C	-	-	-	-	-	-	-	-	-	-	-	-	-	-	-	-	-	-	-		
	Gas Water Heater 煤氣熱水爐	TGC	TNJW221TFQL	✓	✓	-	-	-	-	✓	-	-	✓	✓	-	-	✓	-	-	-	-	
			TNJW161TFQL	-	-	-	✓	-	-	-	✓	-	-	-	✓	-	-	✓	-	-	✓	
			TNJW221TFL	-	-	-	-	-	-	-	-	-	-	-	-	-	-	-	-	-	-	
TNJW161TFL			-	-	-	-	-	-	-	-	-	-	-	-	✓	-	-	✓	-	-		
Exhaust Fan 抽氣扇	Östberg 奧斯博格	LPK 125B1-c	✓	✓	-	✓	-	✓	✓	✓	-	✓	✓	-	-	✓	-	-	-			
	Imasu 伊馬司	HAE13-15B2	-	-	-	-	-	-	-	-	-	-	-	✓	✓	-	✓	✓	✓			

The vendor undertakes that if lifts or appliances of the specified brand name or model number are not installed in the Phase, lifts or appliances of comparable quality will be installed.

賣方承諾如期數中沒有安裝指明的品牌名稱或產品型號的升降機或設備，便會安裝品質相若的升降機或設備。

Remarks :

1. "✓" means such appliance(s) is / are provided and / or installed in the residential property.
2. "-" denotes "not applicable".
3. 13/F, 14/F, 24/F, 34/F, 44/F and 54/F are omitted.

備註：

1. "✓" 表示此設備於該住宅物業內提供及/或安裝。
2. "-" 代表 "不適用"。
3. 不設13樓、14樓、24樓、34樓、44樓及54樓。

Fittings, finishes and appliances

裝置、裝修物料及設備

Appliances Schedule 設備說明表

Location 位置	Appliance 設備	Brand Name 品牌名稱	Model No. 產品型號	Tower 5 (5A) 第5座 (5A)										Tower 5 (5B) 第5座 (5B)							
				7/F-12/F, 15/F-16/F, 18/F-23/F, 25/F-33/F, 35/F-39/F, 41/F-43/F, 45/F-53/F & 55/F-61/F 7樓至12樓, 15樓至16樓, 18樓至23樓, 25樓至33樓, 35樓至39樓, 41樓至43樓, 45樓至53樓及55樓至61樓					62/F 62樓					7/F-12/F, 15/F-16/F, 18/F-23/F, 25/F-33/F, 35/F-39/F, 41/F-43/F, 45/F-53/F & 55/F-61/F 7樓至12樓, 15樓至16樓, 18樓至23樓, 25樓至33樓, 35樓至39樓, 41樓至43樓, 45樓至53樓及55樓至61樓					62/F 62樓		
				A	B	C	D	E	A	B	D	E	A	B	C	D	A	C	D		
Kitchen 廚房	Gas Hob (2-burners) 雙頭氣體煮食爐	Miele	CS 1013-1	✓	✓	-	✓	-	✓	✓	✓	-	✓	✓	✓	✓	✓	✓	✓		
	Gas Hob (Wok Burner) 炒鑊氣體煮食爐	Miele	CS 1018 G	✓	✓	-	✓	-	✓	✓	✓	-	✓	✓	✓	✓	✓	✓	✓		
	Built-in Oven with Microwave 嵌入式微波焗爐	Siemens 西門子	CM656GBS1B	-	✓	-	✓	-	-	✓	✓	-	-	-	✓	✓	-	✓	✓		
	Oven with Microwave 微波焗爐	Miele	H 7240 BM	✓	-	-	-	-	✓	-	-	-	✓	✓	-	-	✓	-	-		
	Barbecue Grill 燒烤爐	Miele	CS 1312 BG	-	-	-	-	-	✓	-	-	-	-	-	-	-	✓	-	-		
	Steam Oven 蒸爐	Miele	DG 7240	-	-	-	-	-	✓	-	-	-	-	-	-	-	✓	-	-		
	90cm Telescopic Hood 90厘米拉趟式抽油煙機	Siemens 西門子	LI97SA530B	✓	✓	-	✓	-	-	✓	✓	-	✓	✓	✓	✓	-	✓	✓		
	Cooker Hood 抽油煙機	Miele	DA 4228 W	-	-	-	-	-	✓	-	-	-	-	-	-	-	✓	-	-		
	Built-in 2 Doors Refrigerator, Bottom Freezer 嵌入式雙門雪櫃	Siemens 西門子	KI86NAF31K	✓	✓	-	✓	-	-	✓	✓	-	✓	✓	✓	✓	-	✓	✓		
	Built-in Fridge-freezer 嵌入式雪櫃連冰箱	Miele	KFNS 37232 iD	-	-	-	-	-	✓	-	-	-	-	-	-	-	✓	-	-		

The vendor undertakes that if lifts or appliances of the specified brand name or model number are not installed in the Phase, lifts or appliances of comparable quality will be installed.

Remarks :

1. "✓" means such appliance(s) is / are provided and / or installed in the residential property.
2. "-" denotes "not applicable".
3. 13/F, 14/F, 24/F, 34/F, 44/F and 54/F are omitted.

賣方承諾如期數中沒有安裝指明的品牌名稱或產品型號的升降機或設備，便會安裝品質相若的升降機或設備。

備註：

1. "✓" 表示此設備於該住宅物業內提供及/或安裝。
2. "-" 代表 "不適用"。
3. 不設13樓、14樓、24樓、34樓、44樓及54樓。

Fittings, finishes and appliances

裝置、裝修物料及設備

Appliances Schedule 設備說明表

Location 位置	Appliance 設備	Brand Name 品牌名稱	Model No. 產品型號	Tower 5 (5A) 第5座 (5A)										Tower 5 (5B) 第5座 (5B)							
				7/F-12/F, 15/F-16/F, 18/F-23/F, 25/F-33/F, 35/F-39/F, 41/F-43/F, 45/F-53/F & 55/F-61/F 7樓至12樓, 15樓至16樓, 18樓至23樓, 25樓至33樓, 35樓至39樓, 41樓至43樓, 45樓至53樓及55樓至61樓					62/F 62樓					7/F-12/F, 15/F-16/F, 18/F-23/F, 25/F-33/F, 35/F-39/F, 41/F-43/F, 45/F-53/F & 55/F-61/F 7樓至12樓, 15樓至16樓, 18樓至23樓, 25樓至33樓, 35樓至39樓, 41樓至43樓, 45樓至53樓及55樓至61樓					62/F 62樓		
				A	B	C	D	E	A	B	D	E	A	B	C	D	A	C	D		
Utility Room 工作間	Split-type Air-conditioner (Indoor Unit) 分體空調機 (室內機)	Daikin 大金	FTXS25EVMA8	-	-	-	-	-	-	-	-	-	-	-	-	-	-	-	-		
			FTXS35EVMA8	-	-	-	-	-	-	-	-	-	-	-	-	-	-	-	-	-	
			FTXS50FVMA8	-	-	-	-	-	-	-	-	-	-	-	-	-	-	-	-	-	
			FTXS60FVMA8	-	-	-	-	-	-	-	-	-	-	-	-	-	-	-	-	-	
			FTXS71FVMA8	-	-	-	-	-	-	-	-	-	-	-	-	-	-	-	-	-	
			FTXS20DVMA	-	-	-	-	-	✓	-	-	-	-	-	-	-	✓	-	-	-	
			FDXS25CVMA	-	-	-	-	-	-	-	-	-	-	-	-	-	-	-	-	-	
			FTXS35EVMA	-	-	-	-	-	-	-	-	-	-	-	-	-	-	-	-	-	
			FTXS50FVMA	-	-	-	-	-	-	-	-	-	-	-	-	-	-	-	-	-	
			FTXS60FVMA	-	-	-	-	-	-	-	-	-	-	-	-	-	-	-	-	-	
			FTXS71FVMA	-	-	-	-	-	-	-	-	-	-	-	-	-	-	-	-	-	
	Split-type Air-Conditioner (Outdoor Unit) 分體空調機 (室外機)	Daikin 大金	RXS25EBVMA	-	-	-	-	-	-	-	-	-	-	-	-	-	-	-	-		
			RXS35EBVMA	-	-	-	-	-	-	-	-	-	-	-	-	-	-	-	-		
			RXS50FVMA	-	-	-	-	-	-	-	-	-	-	-	-	-	-	-	-		
			RXS60FVMA	-	-	-	-	-	-	-	-	-	-	-	-	-	-	-	-		
			RXS71FVMA	-	-	-	-	-	-	-	-	-	-	-	-	-	-	-	-		
			3MXS52EVMA	-	-	-	-	-	✓	-	-	-	-	-	-	-	✓	-	-		
			4MXS80EVMA	-	-	-	-	-	-	-	-	-	-	-	-	-	-	-	-		
			4MXS100AA	-	-	-	-	-	-	-	-	-	-	-	-	-	-	-	-		
	4MXS115HV2C	-	-	-	-	-	-	-	-	-	-	-	-	-	-	-	-				
Freestanding Washing Machine 洗衣機	Miele	WED 125	-	-	-	-	-	✓	-	-	-	-	-	-	✓	-	-				
Heat Pump Tumble Dryer 乾衣機	Miele	TEB 145 WP	-	-	-	-	-	✓	-	-	-	-	-	-	✓	-	-				

The vendor undertakes that if lifts or appliances of the specified brand name or model number are not installed in the Phase, lifts or appliances of comparable quality will be installed.

Remarks :

1. "✓" means such appliance(s) is / are provided and / or installed in the residential property.
2. "-" denotes "not applicable".
3. 13/F, 14/F, 24/F, 34/F, 44/F and 54/F are omitted.

賣方承諾如期數中沒有安裝指明的品牌名稱或產品型號的升降機或設備，便會安裝品質相若的升降機或設備。

備註：

1. "✓" 表示此設備於該住宅物業內提供及/或安裝。
2. "-" 代表 "不適用"。
3. 不設13樓、14樓、24樓、34樓、44樓及54樓。

Fittings, finishes and appliances

裝置、裝修物料及設備

Appliances Schedule 設備說明表

Location 位置	Appliance 設備	Brand Name 品牌名稱	Model No. 產品型號	Tower 5 (5A) 第5座 (5A)										Tower 5 (5B) 第5座 (5B)					
				7/F-12/F, 15/F-16/F, 18/F-23/F, 25/F-33/F, 35/F-39/F, 41/F-43/F, 45/F-53/F & 55/F-61/F 7樓至12樓, 15樓至16樓, 18樓至23樓, 25樓至33樓, 35樓至39樓, 41樓至43樓, 45樓至53樓及55樓至61樓					62/F 62樓					7/F-12/F, 15/F-16/F, 18/F-23/F, 25/F-33/F, 35/F-39/F, 41/F-43/F, 45/F-53/F & 55/F-61/F 7樓至12樓, 15樓至16樓, 18樓至23樓, 25樓至33樓, 35樓至39樓, 41樓至43樓, 45樓至53樓及55樓至61樓				62/F 62樓	
				A	B	C	D	E	A	B	D	E	A	B	C	D	A	C	D
Open Kitchen 開放式廚房	Electric Water Heater 電熱水爐	Stiebel Eltron 斯寶亞創	DHB 27 STi	-	-	-	-	-	-	-	-	-	-	-	-	-	-	-	-
	FlexInduction Plus Hob 60cm 嵌入式60厘米FlexInduction電磁爐	Siemens 西門子	EX675LYC1E	-	-	✓	-	✓	-	-	-	✓	-	-	-	-	-	-	-
	Built-in Oven with Microwave 嵌入式微波焗爐	Siemens 西門子	CM656GBS1B	-	-	✓	-	✓	-	-	-	✓	-	-	-	-	-	-	-
	60cm Telescopic Hood 60厘米拉趟式抽油煙機	Siemens 西門子	LI67SA530B	-	-	✓	-	✓	-	-	-	✓	-	-	-	-	-	-	-
	Built-in 2 Doors Refrigerator, Bottom Freezer 嵌入式雙門雪櫃	Siemens 西門子	KI86NAF31K	-	-	✓	-	✓	-	-	-	✓	-	-	-	-	-	-	-
Bathroom 浴室	Electric Water Heater 電熱水爐	Stiebel Eltron 斯寶亞創	DHB 27 STi	-	-	✓	-	✓	-	-	-	✓	-	-	-	-	-	-	-
	Gas Water Heater 煤氣熱水爐	TGC	TNJW221TFQL TNJW161TFL	-	-	-	-	-	-	-	-	-	-	-	-	-	-	-	-
	Thermo-ventilator 浴室換氣暖風機	Panasonic 樂聲牌	FV-40BE2H	-	-	✓	✓	✓	-	-	✓	✓	-	-	✓	✓	-	✓	✓
	Exhaust Fan 抽氣扇	Östberg 奧斯博格	LPK 125B1-c	-	-	✓	✓	✓	-	-	✓	✓	-	-	✓	✓	-	✓	✓
		Imasu 伊馬司	HAE13-15B2	-	-	-	-	-	-	-	-	-	-	-	-	-	-	-	-
	Built-in Washer Dryer 嵌入式洗衣乾衣機	Gorenje	WDI73121HK	-	-	✓	✓	✓	-	-	✓	✓	-	-	✓	✓	-	✓	✓
Bathroom 1 浴室 1	Electric Water Heater 電熱水爐	Stiebel Eltron 斯寶亞創	DHB 27 STi	-	-	-	-	-	-	-	-	-	-	-	-	-	-	-	-
	Gas Water Heater 煤氣熱水爐	TGC	TNJW221TFQL TNJW161TFL	-	-	-	-	-	-	-	-	-	-	-	-	-	-	-	-
	Thermo-ventilator 浴室換氣暖風機	Panasonic 樂聲牌	FV-40BE2H	✓	✓	-	-	-	✓	✓	-	-	✓	✓	-	-	✓	-	-
	Exhaust Fan 抽氣扇	Östberg 奧斯博格	LPK 125B1-c	✓	✓	-	-	-	✓	✓	-	-	✓	-	-	-	✓	-	-
		Imasu 伊馬司	HAE13-15B2	-	-	-	-	-	-	-	-	-	-	✓	-	-	-	-	-

The vendor undertakes that if lifts or appliances of the specified brand name or model number are not installed in the Phase, lifts or appliances of comparable quality will be installed.

賣方承諾如期數中沒有安裝指明的品牌名稱或產品型號的升降機或設備，便會安裝品質相若的升降機或設備。

Remarks :

1. "✓" means such appliance(s) is / are provided and / or installed in the residential property.
2. "-" denotes "not applicable".
3. 13/F, 14/F, 24/F, 34/F, 44/F and 54/F are omitted.

備註：

1. "✓" 表示此設備於該住宅物業內提供及/或安裝。
2. "-" 代表 "不適用"。
3. 不設13樓、14樓、24樓、34樓、44樓及54樓。

Fittings, finishes and appliances

裝置、裝修物料及設備

Appliances Schedule 設備說明表

Location 位置	Appliance 設備	Brand Name 品牌名稱	Model No. 產品型號	Tower 5 (5A) 第5座 (5A)										Tower 5 (5B) 第5座 (5B)					
				7/F-12/F, 15/F-16/F, 18/F-23/F, 25/F-33/F, 35/F-39/F, 41/F-43/F, 45/F-53/F & 55/F-61/F 7樓至12樓, 15樓至16樓, 18樓至23樓, 25樓至33樓, 35樓至39樓, 41樓至43樓, 45樓至53樓及55樓至61樓					62/F 62樓					7/F-12/F, 15/F-16/F, 18/F-23/F, 25/F-33/F, 35/F-39/F, 41/F-43/F, 45/F-53/F & 55/F-61/F 7樓至12樓, 15樓至16樓, 18樓至23樓, 25樓至33樓, 35樓至39樓, 41樓至43樓, 45樓至53樓及55樓至61樓				62/F 62樓	
				A	B	C	D	E	A	B	D	E	A	B	C	D	A	C	D
Bathroom 2 浴室 2	Electric Water Heater 電熱水爐	Stiebel Eltron 斯寶亞創	DHB 27 STi	-	-	-	-	-	-	-	-	-	-	-	-	-	-	-	-
	Gas Water Heater 煤氣熱水爐	TGC	TNJW221TFQL	-	-	-	-	-	-	-	-	-	-	-	-	-	-	-	-
			TNJW161TFL	-	-	-	-	-	-	-	-	-	-	-	-	-	-	-	-
	Thermo-ventilator 浴室換氣暖風機	Panasonic 樂聲牌	FV-40BE2H	✓	✓	-	-	-	✓	✓	-	-	✓	✓	-	-	✓	-	-
	Exhaust Fan 抽氣扇	Östberg 奧斯博格	LPK 125B1-c	-	✓	-	-	-	✓	✓	-	-	✓	-	-	-	✓	-	-
Imasu 伊馬司		HAE13-15B2	✓	-	-	-	-	-	-	-	-	-	✓	-	-	-	-	-	
Built-in Washer Dryer 嵌入式洗衣乾衣機	Gorenje	WDI73121HK	✓	✓	-	-	-	-	✓	-	-	✓	✓	-	-	-	-	-	
Bathroom 3 浴室 3	Electric Water Heater 電熱水爐	Stiebel Eltron 斯寶亞創	DHB 27 STi	-	-	-	-	-	-	-	-	-	-	-	-	-	-	-	
	Gas Water Heater 煤氣熱水爐	TGC	TNJW221TFQL	-	-	-	-	-	-	-	-	-	-	-	-	-	✓	-	-
			TNJW161TFL	-	-	-	-	-	-	-	-	-	-	-	-	-	-	-	-
	Thermo-ventilator 浴室換氣暖風機	Panasonic 樂聲牌	FV-40BE2H	-	-	-	-	-	-	-	-	-	-	-	-	-	✓	-	-
	Exhaust Fan 抽氣扇	Östberg 奧斯博格	LPK 125B1-c	-	-	-	-	-	-	-	-	-	-	-	-	-	✓	-	-
Imasu 伊馬司		HAE13-15B2	-	-	-	-	-	-	-	-	-	-	-	-	-	-	-	-	
Toilet 洗手間	Exhaust Fan 抽氣扇	Östberg 奧斯博格	LPK 125B1-c	-	-	-	-	-	-	-	-	-	-	-	-	-	-	-	
		Imasu 伊馬司	HAE13-15B2	-	-	-	-	-	✓	-	-	-	-	-	-	-	✓	-	-
	Gas Water Heater 煤氣熱水爐	TGC	TNJW221TFQL	-	-	-	-	-	✓	-	-	-	-	-	-	-	-	-	
			TNJW221TFL	-	-	-	-	-	✓	-	-	-	-	-	-	-	-	-	

The vendor undertakes that if lifts or appliances of the specified brand name or model number are not installed in the Phase, lifts or appliances of comparable quality will be installed.

Remarks :

1. "✓" means such appliance(s) is / are provided and / or installed in the residential property.
2. "-" denotes "not applicable".
3. 13/F, 14/F, 24/F, 34/F, 44/F and 54/F are omitted.

賣方承諾如期數中沒有安裝指明的品牌名稱或產品型號的升降機或設備，便會安裝品質相若的升降機或設備。

備註：

1. "✓" 表示此設備於該住宅物業內提供及/或安裝。
2. "-" 代表 "不適用"。
3. 不設13樓、14樓、24樓、34樓、44樓及54樓。

Fittings, finishes and appliances

裝置、裝修物料及設備

Appliances Schedule 設備說明表

Location 位置	Appliance 設備	Brand Name 品牌名稱	Model No. 產品型號	Tower 6 (6A) 第6座 (6A)												Tower 6 (6B) 第6座 (6B)															
				7/F-12/F, 15/F-16/F, 18/F-23/F, 25/F-33/F & 35/F-39/F 7樓至12樓, 15樓至16樓, 18樓至23樓, 25樓至33樓 及35樓至39樓					41/F-43/F, 45/F-53/F & 55/F-61/F 41樓至43樓, 45樓至53樓及 55樓至61樓					62/F 62樓				7/F-12/F, 15/F-16/F, 18/F-23/F, 25/F-33/F & 35/F-39/F 7樓至12樓, 15樓至16樓, 18樓至23樓, 25樓至33樓 及35樓至39樓					41/F-43/F, 45/F-53/F & 55/F-61/F 41樓至43樓, 45樓至53樓及 55樓至61樓					62/F 62樓			
				A	B	C	D	E	A	B	C	D	E	A	C	D	E	A	C	D	E	F	A	C	E	F	A	C	E	F	
Living Room/ Dining Room/ Master Bedroom/ Bedrooms 客廳 / 飯廳 / 主人睡房 / 睡房	Split-type Air-conditioner (Indoor Unit) 分體空調機 (室內機)	Daikin 大金	FTXS25EVMA8	-	-	-	-	-	-	-	-	-	-	-	-	-	-	-	-	-	-	-	-	-	-	-	-	-	-		
			FTXS35EVMA8	✓	-	-	-	-	✓	-	-	-	-	✓	-	-	-	✓	-	-	-	-	✓	-	-	-	✓	-	-	-	
			FTXS50FVMA8	-	-	-	-	-	-	-	-	-	-	✓	-	-	-	-	-	-	-	-	-	-	-	-	-	-	-	-	
			FTXS60FVMA8	✓	-	✓	✓	✓	✓	-	✓	✓	✓	-	✓	✓	✓	✓	✓	✓	-	✓	✓	✓	✓	✓	-	✓	✓	-	✓
			FTXS71FVMA8	-	-	-	-	-	-	-	-	-	-	✓	-	-	-	-	-	-	-	-	-	-	-	-	-	-	-	-	
			FTXS25EVMA	✓	✓	✓	✓	✓	✓	✓	✓	✓	✓	-	✓	✓	✓	✓	✓	✓	-	✓	✓	-	✓	✓	✓	✓	✓	-	✓
			FDXS25CVMA	-	-	-	-	-	-	-	-	-	-	-	-	-	-	-	-	-	-	-	-	-	-	-	-	-	-	-	
			FTXS35EVMA	-	✓	✓	✓	✓	-	✓	✓	✓	✓	✓	✓	✓	✓	✓	-	✓	-	✓	✓	-	-	✓	✓	-	-	✓	✓
			FTXS50FVMA	-	-	-	-	-	-	-	-	-	-	-	-	-	-	-	-	-	-	-	-	-	✓	-	-	-	✓	-	-
			FTXS60FVMA	-	-	-	-	-	-	-	-	-	-	-	-	-	-	-	-	-	-	-	-	-	-	-	-	-	-	-	-
	FTXS71FVMA	-	✓	-	-	-	-	✓	-	-	-	-	-	-	-	-	-	-	-	✓	-	-	✓	✓	-	-	✓	✓	-		
	Split-type Air-conditioner (Outdoor Unit) 分體空調機 (室外機)	Daikin 大金	RXS25EBVMA	-	-	-	-	-	-	-	-	-	-	-	-	-	-	-	-	-	-	-	-	-	-	-	-	-	-		
			RXS35EBVMA	✓	-	-	-	-	✓	-	-	-	-	✓	-	-	-	✓	-	-	-	-	✓	-	-	-	✓	-	-	-	
			RXS50FVMA	-	-	-	-	-	-	-	-	-	-	✓	-	-	-	-	-	-	-	-	-	-	-	-	-	-	-	-	
RXS60FVMA			✓	-	✓	✓	✓	✓	-	✓	✓	✓	-	✓	✓	✓	✓	✓	✓	-	✓	✓	-	✓	✓	-	✓	✓	-	✓	
RXS71FVMA			-	-	-	-	-	-	-	-	-	-	✓	-	-	-	-	-	-	-	-	-	-	-	-	-	-	-	-		
3MXS52EVMA			✓	✓	✓	✓	✓	✓	✓	✓	✓	✓	✓	✓	✓	✓	✓	✓	✓	-	✓	✓	-	✓	✓	✓	✓	✓	-	✓	
4MXS80EVMA			-	-	-	-	-	-	-	-	-	-	-	-	-	-	-	-	-	-	-	-	-	✓	-	-	-	✓	-	-	
4MXS100AA	-	✓	-	-	-	-	✓	-	-	-	-	-	-	-	-	-	-	-	-	-	-	-	-	-	-	-	-				
4MXS115HV2C	-	-	-	-	-	-	-	-	-	-	-	-	-	-	-	-	-	✓	-	-	✓	✓	-	-	✓	✓	-	-			
Living Room/ Dining Room 客廳 / 飯廳	Built-in Fridge-freezer 嵌入式雪櫃連冰箱	Miele	KFNS 37232 iD	-	-	-	-	-	-	-	-	-	✓	-	-	-	-	-	-	-	-	-	-	-	-	-	-	-			
	Mastercool Wine Conditioning Unit Mastercool 酒櫃	Miele	KWT 2611 Vi	-	-	-	-	-	-	-	-	-	✓	-	-	-	-	-	-	-	-	-	-	-	-	-	-	-			
	Coffee Machine 咖啡機	Miele	CVA 7440	-	-	-	-	-	-	-	-	-	✓	-	-	-	-	-	-	-	-	-	-	-	-	-	-	-			
	Gourmet Warming Drawer 食物保溫櫃	Miele	ESW 7010	-	-	-	-	-	-	-	-	-	✓	-	-	-	-	-	-	-	-	-	-	-	-	-	-	-			

The vendor undertakes that if lifts or appliances of the specified brand name or model number are not installed in the Phase, lifts or appliances of comparable quality will be installed.

Remarks :

1. "✓" means such appliance(s) is / are provided and / or installed in the residential property.
2. "-" denotes "not applicable".
3. 13/F, 14/F, 24/F, 34/F, 44/F and 54/F are omitted.

賣方承諾如期數中沒有安裝指明的品牌名稱或產品型號的升降機或設備，便會安裝品質相若的升降機或設備。

備註：

1. "✓" 表示此設備於該住宅物業內提供及/或安裝。
2. "-" 代表 "不適用"。
3. 不設13樓、14樓、24樓、34樓、44樓及54樓。

Fittings, finishes and appliances

裝置、裝修物料及設備

Appliances Schedule 設備說明表

Location 位置	Appliance 設備	Brand Name 品牌名稱	Model No. 產品型號	Tower 6 (6A) 第6座 (6A)												Tower 6 (6B) 第6座 (6B)																
				7/F-12/F, 15/F-16/F, 18/F-23/F, 25/F-33/F & 35/F-39/F 7樓至12樓, 15樓至16樓, 18樓至23樓, 25樓至33樓 及35樓至39樓					41/F-43/F, 45/F-53/F & 55/F-61/F 41樓至43樓, 45樓至53樓及 55樓至61樓					62/F 62樓		7/F-12/F, 15/F-16/F, 18/F-23/F, 25/F-33/F & 35/F-39/F 7樓至12樓, 15樓至16樓, 18樓至23樓, 25樓至33樓 及35樓至39樓					41/F-43/F, 45/F-53/F & 55/F-61/F 41樓至43樓, 45樓至53樓及 55樓至61樓					62/F 62樓						
				A	B	C	D	E	A	B	C	D	E	A	C	D	E	A	C	D	E	F	A	C	E	F	A	C	E	F		
Store 儲物房	Split-type Air-conditioner (Indoor Unit) 分體空調機 (室內機)	Daikin 大金	FTXS25EVMA8	-	-	-	-	-	-	-	-	-	-	-	-	-	-	-	-	-	-	-	-	-	-	-	-	-	-			
			FTXS35EVMA8	-	-	-	-	-	-	-	-	-	-	-	-	-	-	-	-	-	-	-	-	-	-	-	-	-	-	-		
			FTXS50FVMA8	-	-	-	-	-	-	-	-	-	-	-	-	-	-	-	-	-	-	-	-	-	-	-	-	-	-	-		
			FTXS60FVMA8	-	-	-	-	-	-	-	-	-	-	-	-	-	-	-	-	-	-	-	-	-	-	-	-	-	-	-		
			FTXS71FVMA8	-	-	-	-	-	-	-	-	-	-	-	-	-	-	-	-	-	-	-	-	-	-	-	-	-	-	-		
			FTXS25EVMA	-	✓	-	-	-	-	✓	-	-	-	-	-	-	-	-	-	-	-	-	-	-	✓	-	-	-	✓	-	-	
			FDXS25CVMA	-	-	-	-	-	-	-	-	-	-	-	-	-	-	-	-	-	-	-	-	-	-	-	-	-	-	-	-	
			FTXS35EVMA	-	-	-	-	-	-	-	-	-	-	-	-	-	-	-	-	-	-	-	-	-	-	-	-	-	-	-	-	
			FTXS50FVMA	-	-	-	-	-	-	-	-	-	-	-	-	-	-	-	-	-	-	-	-	-	-	-	-	-	-	-	-	-
			FTXS60FVMA	-	-	-	-	-	-	-	-	-	-	-	-	-	-	-	-	-	-	-	-	-	-	-	-	-	-	-	-	-
	FTXS71FVMA	-	-	-	-	-	-	-	-	-	-	-	-	-	-	-	-	-	-	-	-	-	-	-	-	-	-	-	-	-		
	Split-type Air-conditioner (Outdoor Unit) 分體空調機 (室外機)	Daikin 大金	RXS25EBVMA	-	-	-	-	-	-	-	-	-	-	-	-	-	-	-	-	-	-	-	-	-	-	-	-	-	-	-		
			RXS35EBVMA	-	-	-	-	-	-	-	-	-	-	-	-	-	-	-	-	-	-	-	-	-	-	-	-	-	-	-	-	
			RXS50FVMA	-	-	-	-	-	-	-	-	-	-	-	-	-	-	-	-	-	-	-	-	-	-	-	-	-	-	-	-	
			RXS60FVMA	-	-	-	-	-	-	-	-	-	-	-	-	-	-	-	-	-	-	-	-	-	-	-	-	-	-	-	-	
			RXS71FVMA	-	-	-	-	-	-	-	-	-	-	-	-	-	-	-	-	-	-	-	-	-	-	-	-	-	-	-	-	
			3MXS52EVMA	-	-	-	-	-	-	-	-	-	-	-	-	-	-	-	-	-	-	-	-	-	-	-	-	-	-	-	-	
			4MXS80EVMA	-	-	-	-	-	-	-	-	-	-	-	-	-	-	-	-	-	-	-	-	-	✓	-	-	-	✓	-	-	
			4MXS100AA	-	✓	-	-	-	-	✓	-	-	-	-	-	-	-	-	-	-	-	-	-	-	-	-	-	-	-	-	-	
4MXS115HV2C			-	-	-	-	-	-	-	-	-	-	-	-	-	-	-	-	-	-	-	-	-	-	-	-	-	-	-	-		

The vendor undertakes that if lifts or appliances of the specified brand name or model number are not installed in the Phase, lifts or appliances of comparable quality will be installed.

Remarks :

1. "✓" means such appliance(s) is / are provided and / or installed in the residential property.
2. "-" denotes "not applicable".
3. 13/F, 14/F, 24/F, 34/F, 44/F and 54/F are omitted.

賣方承諾如期數中沒有安裝指明的品牌名稱或產品型號的升降機或設備，便會安裝品質相若的升降機或設備。

備註：

1. "✓" 表示此設備於該住宅物業內提供及/或安裝。
2. "-" 代表 "不適用"。
3. 不設13樓、14樓、24樓、34樓、44樓及54樓。

Fittings, finishes and appliances

裝置、裝修物料及設備

Appliances Schedule 設備說明表

Location 位置	Appliance 設備	Brand Name 品牌名稱	Model No. 產品型號	Tower 6 (6A) 第6座 (6A)												Tower 6 (6B) 第6座 (6B)															
				7/F-12/F, 15/F-16/F, 18/F-23/F, 25/F-33/F & 35/F-39/F 7樓至12樓, 15樓至16樓, 18樓至23樓, 25樓至33樓 及35樓至39樓					41/F-43/F, 45/F-53/F & 55/F-61/F 41樓至43樓, 45樓至53樓及 55樓至61樓					62/F 62樓				7/F-12/F, 15/F-16/F, 18/F-23/F, 25/F-33/F & 35/F-39/F 7樓至12樓, 15樓至16樓, 18樓至23樓, 25樓至33樓 及35樓至39樓					41/F-43/F, 45/F-53/F & 55/F-61/F 41樓至43樓, 45樓至53樓及 55樓至61樓					62/F 62樓			
				A	B	C	D	E	A	B	C	D	E	A	C	D	E	A	C	D	E	F	A	C	E	F	A	C	E	F	
Kitchen 廚房	Split-type Air-conditioner (Indoor Unit) 分體空調機 (室內機)	Daikin 大金	FTXS25EVMA8	-	-	-	-	-	-	-	-	-	-	-	-	-	-	-	-	-	-	-	-	-	-	-	-	-	-		
			FTXS35EVMA8	-	-	-	-	-	-	-	-	-	-	-	-	-	-	-	-	-	-	-	-	-	-	-	-	-	-	-	
			FTXS50FVMA8	-	-	-	-	-	-	-	-	-	-	-	-	-	-	-	-	-	-	-	-	-	-	-	-	-	-	-	
			FTXS60FVMA8	-	-	-	-	-	-	-	-	-	-	-	-	-	-	-	-	-	-	-	-	-	-	-	-	-	-	-	
			FTXS71FVMA8	-	-	-	-	-	-	-	-	-	-	-	-	-	-	-	-	-	-	-	-	-	-	-	-	-	-	-	
			FTXS25EVMA	-	-	-	-	-	-	-	-	-	-	-	-	-	-	-	-	-	-	-	-	-	-	-	-	-	-	-	-
			FDXS35CVMA	-	-	-	-	-	-	-	-	-	-	✓	-	-	-	-	-	-	-	-	-	-	-	-	-	-	-	-	-
			FTXS35EVMA	-	-	-	-	-	-	-	-	-	-	-	-	-	-	-	-	-	-	-	-	-	-	-	-	-	-	-	-
			FTXS50FVMA	-	-	-	-	-	-	-	-	-	-	-	-	-	-	-	-	-	-	-	-	-	-	-	-	-	-	-	-
			FTXS60FVMA	-	-	-	-	-	-	-	-	-	-	-	-	-	-	-	-	-	-	-	-	-	-	-	-	-	-	-	-
	FTXS71FVMA	-	-	-	-	-	-	-	-	-	-	-	-	-	-	-	-	-	-	-	-	-	-	-	-	-	-	-	-		
	Split-type Air-conditioner (Outdoor Unit) 分體空調機 (室外機)	Daikin 大金	RXS25EBVMA	-	-	-	-	-	-	-	-	-	-	-	-	-	-	-	-	-	-	-	-	-	-	-	-	-	-		
			RXS35EBVMA	-	-	-	-	-	-	-	-	-	-	-	-	-	-	-	-	-	-	-	-	-	-	-	-	-	-	-	
			RXS50FVMA	-	-	-	-	-	-	-	-	-	-	-	-	-	-	-	-	-	-	-	-	-	-	-	-	-	-	-	
			RXS60FVMA	-	-	-	-	-	-	-	-	-	-	-	-	-	-	-	-	-	-	-	-	-	-	-	-	-	-	-	
			RXS71FVMA	-	-	-	-	-	-	-	-	-	-	-	-	-	-	-	-	-	-	-	-	-	-	-	-	-	-	-	
			3MXS52EVMA	-	-	-	-	-	-	-	-	-	-	✓	-	-	-	-	-	-	-	-	-	-	-	-	-	-	-	-	
			4MXS80EVMA	-	-	-	-	-	-	-	-	-	-	-	-	-	-	-	-	-	-	-	-	-	-	-	-	-	-	-	
			4MXS100AA	-	-	-	-	-	-	-	-	-	-	-	-	-	-	-	-	-	-	-	-	-	-	-	-	-	-	-	
	4MXS115HV2C	-	-	-	-	-	-	-	-	-	-	-	-	-	-	-	-	-	-	-	-	-	-	-	-	-	-	-			
	Gas Water Heater 煤氣熱水爐	TGC	TNJW221TFQL	✓	✓	-	-	-	✓	✓	-	-	-	-	-	-	✓	-	-	-	-	✓	✓	-	-	✓	✓	-	-		
			TNJW161TFQL	-	-	-	-	-	-	-	-	-	-	-	-	-	-	✓	-	-	-	-	-	-	-	-	-	-	-		
TNJW221TFL			-	-	-	-	-	-	-	-	-	-	-	-	-	-	-	-	-	-	-	-	-	-	-	-	-	-			
TNJW161TFL			-	-	-	-	-	-	-	-	-	-	-	-	-	-	-	-	-	-	-	-	-	-	-	-	-	-			
Exhaust Fan 抽氣扇	Östberg 奧斯博格	LPK 125B1-c	✓	✓	-	-	-	✓	✓	-	-	-	✓	-	-	-	-	-	-	-	-	-	-	-	-	-	-	-			
	Imasu 伊馬司	HAE13-15B2	-	-	-	-	-	-	-	-	-	-	-	-	-	-	-	✓	✓	-	-	-	✓	✓	-	-	✓	✓			

The vendor undertakes that if lifts or appliances of the specified brand name or model number are not installed in the Phase, lifts or appliances of comparable quality will be installed.

Remarks :

1. "✓" means such appliance(s) is / are provided and / or installed in the residential property.
2. "-" denotes "not applicable".
3. 13/F, 14/F, 24/F, 34/F, 44/F and 54/F are omitted.

賣方承諾如期數中沒有安裝指明的品牌名稱或產品型號的升降機或設備，便會安裝品質相若的升降機或設備。

備註 :

1. "✓" 表示此設備於該住宅物業內提供及/或安裝。
2. "-" 代表 "不適用"。
3. 不設13樓、14樓、24樓、34樓、44樓及54樓。

Fittings, finishes and appliances

裝置、裝修物料及設備

Appliances Schedule 設備說明表

Location 位置	Appliance 設備	Brand Name 品牌名稱	Model No. 產品型號	Tower 6 (6A) 第6座 (6A)												Tower 6 (6B) 第6座 (6B)															
				7/F-12/F, 15/F-16/F, 18/F-23/F, 25/F-33/F & 35/F-39/F 7樓至12樓, 15樓至16樓, 18樓至23樓, 25樓至33樓 及35樓至39樓					41/F-43/F, 45/F-53/F & 55/F-61/F 41樓至43樓, 45樓至53樓及 55樓至61樓					62/F 62樓				7/F-12/F, 15/F-16/F, 18/F-23/F, 25/F-33/F & 35/F-39/F 7樓至12樓, 15樓至16樓, 18樓至23樓, 25樓至33樓 及35樓至39樓					41/F-43/F, 45/F-53/F & 55/F-61/F 41樓至43樓, 45樓至53樓及 55樓至61樓					62/F 62樓			
				A	B	C	D	E	A	B	C	D	E	A	C	D	E	A	C	D	E	F	A	C	E	F	A	C	E	F	
Kitchen 廚房	Gas Hob (2-burners) 雙頭氣體煮食爐	Miele	CS 1013-1	✓	✓	-	-	-	✓	✓	-	-	-	✓	-	-	-	✓	✓	-	-	-	✓	✓	-	-	✓	✓	-	-	
	Gas Hob (Wok Burner) 炒鑊氣體煮食爐	Miele	CS1018 G	✓	✓	-	-	-	✓	✓	-	-	-	✓	-	-	-	✓	✓	-	-	-	✓	✓	-	-	✓	✓	-	-	
	Built-in Oven with Microwave 嵌入式微波焗爐	Siemens 西門子	CM656GBS1B	-	✓	-	-	-	-	✓	-	-	-	-	-	-	-	-	✓	-	-	-	-	-	-	-	-	-	-	-	
	Oven with Microwave 微波焗爐	Miele	H 7240 BM	✓	-	-	-	-	✓	-	-	-	-	✓	-	-	-	✓	-	-	-	-	✓	✓	-	-	✓	✓	-	-	
	Barbecue Grill 燒烤爐	Miele	CS 1312 BG	-	-	-	-	-	-	-	-	-	-	✓	-	-	-	-	-	-	-	-	-	-	-	-	-	-	-	-	
	Steam Oven 蒸爐	Miele	DG 7240	-	-	-	-	-	-	-	-	-	-	✓	-	-	-	-	-	-	-	-	-	-	-	-	-	-	-	-	
	90cm Telescopic Hood 90厘米拉趟式抽油煙機	Siemens 西門子	LI97SA530B	✓	✓	-	-	-	✓	✓	-	-	-	-	-	-	-	✓	✓	-	-	-	✓	✓	-	-	✓	✓	-	-	
	Cooker Hood 抽油煙機	Miele	DA 4228 W	-	-	-	-	-	-	-	-	-	-	✓	-	-	-	-	-	-	-	-	-	-	-	-	-	-	-	-	
	Built-in 2 Doors Refrigerator, Bottom Freezer 嵌入式雙門雪櫃	Siemens 西門子	KI86NAF31K	✓	✓	-	-	-	✓	✓	-	-	-	-	-	-	-	✓	✓	-	-	-	✓	✓	-	-	✓	✓	-	-	
	Built-in Wine Storage 嵌入式酒櫃	Gorenje	WCIU3090A1	-	-	-	-	-	-	-	-	-	-	-	-	-	-	-	-	-	-	-	-	✓	-	-	-	✓	-	-	
	Built-in Fridge-freezer 嵌入式雪櫃連冰箱	Miele	KFNS 37232 iD	-	-	-	-	-	-	-	-	-	-	✓	-	-	-	-	-	-	-	-	-	-	-	-	-	-	-	-	

The vendor undertakes that if lifts or appliances of the specified brand name or model number are not installed in the Phase, lifts or appliances of comparable quality will be installed.

Remarks :

1. "✓" means such appliance(s) is / are provided and / or installed in the residential property.
2. "-" denotes "not applicable".
3. 13/F, 14/F, 24/F, 34/F, 44/F and 54/F are omitted.

賣方承諾如期數中沒有安裝指明的品牌名稱或產品型號的升降機或設備，便會安裝品質相若的升降機或設備。

備註：

1. "✓" 表示此設備於該住宅物業內提供及/或安裝。
2. "-" 代表 "不適用"。
3. 不設13樓、14樓、24樓、34樓、44樓及54樓。

Fittings, finishes and appliances

裝置、裝修物料及設備

Appliances Schedule 設備說明表

Location 位置	Appliance 設備	Brand Name 品牌名稱	Model No. 產品型號	Tower 6 (6A) 第6座 (6A)												Tower 6 (6B) 第6座 (6B)																
				7/F-12/F, 15/F-16/F, 18/F-23/F, 25/F-33/F & 35/F-39/F 7樓至12樓, 15樓至16樓, 18樓至23樓, 25樓至33樓 及35樓至39樓					41/F-43/F, 45/F-53/F & 55/F-61/F 41樓至43樓, 45樓至53樓及 55樓至61樓					62/F 62樓		7/F-12/F, 15/F-16/F, 18/F-23/F, 25/F-33/F & 35/F-39/F 7樓至12樓, 15樓至16樓, 18樓至23樓, 25樓至33樓 及35樓至39樓					41/F-43/F, 45/F-53/F & 55/F-61/F 41樓至43樓, 45樓至53樓及 55樓至61樓					62/F 62樓						
				A	B	C	D	E	A	B	C	D	E	A	C	D	E	A	C	D	E	F	A	C	E	F	A	C	E	F		
Utility Room 工作間	Split-type Air-conditioner (Indoor Unit) 分體空調機 (室內機)	Daikin 大金	FTXS25EVMA8	-	-	-	-	-	-	-	-	-	-	-	-	-	-	-	-	-	-	-	-	-	-	-	-	-	-			
			FTXS35EVMA8	-	-	-	-	-	-	-	-	-	-	-	-	-	-	-	-	-	-	-	-	-	-	-	-	-	-	-		
			FTXS50FVMA8	-	-	-	-	-	-	-	-	-	-	-	-	-	-	-	-	-	-	-	-	-	-	-	-	-	-	-		
			FTXS60FVMA8	-	-	-	-	-	-	-	-	-	-	-	-	-	-	-	-	-	-	-	-	-	-	-	-	-	-	-		
			FTXS71FVMA8	-	-	-	-	-	-	-	-	-	-	-	-	-	-	-	-	-	-	-	-	-	-	-	-	-	-	-		
			FTXS20DVMA	-	-	-	-	-	-	-	-	-	-	-	-	✓	-	-	-	-	-	-	-	-	-	-	-	-	-	-	-	
			FDXS25CVMA	-	-	-	-	-	-	-	-	-	-	-	-	-	-	-	-	-	-	-	-	-	-	-	-	-	-	-	-	
			FTXS35EVMA	-	-	-	-	-	-	-	-	-	-	-	-	-	-	-	-	-	-	-	-	-	-	-	-	-	-	-	-	
			FTXS50FVMA	-	-	-	-	-	-	-	-	-	-	-	-	-	-	-	-	-	-	-	-	-	-	-	-	-	-	-	-	-
			FTXS60FVMA	-	-	-	-	-	-	-	-	-	-	-	-	-	-	-	-	-	-	-	-	-	-	-	-	-	-	-	-	-
	FTXS71FVMA	-	-	-	-	-	-	-	-	-	-	-	-	-	-	-	-	-	-	-	-	-	-	-	-	-	-	-	-	-		
	Split-type Air-conditioner (Outdoor Unit) 分體空調機 (室外機)	Daikin 大金	RXS25EBVMA	-	-	-	-	-	-	-	-	-	-	-	-	-	-	-	-	-	-	-	-	-	-	-	-	-	-	-		
			RXS35EBVMA	-	-	-	-	-	-	-	-	-	-	-	-	-	-	-	-	-	-	-	-	-	-	-	-	-	-	-	-	
			RXS50FVMA	-	-	-	-	-	-	-	-	-	-	-	-	-	-	-	-	-	-	-	-	-	-	-	-	-	-	-	-	
			RXS60FVMA	-	-	-	-	-	-	-	-	-	-	-	-	-	-	-	-	-	-	-	-	-	-	-	-	-	-	-	-	
			RXS71FVMA	-	-	-	-	-	-	-	-	-	-	-	-	-	-	-	-	-	-	-	-	-	-	-	-	-	-	-	-	
			3MXS52EVMA	-	-	-	-	-	-	-	-	-	-	-	-	✓	-	-	-	-	-	-	-	-	-	-	-	-	-	-	-	-
			4MXS80EVMA	-	-	-	-	-	-	-	-	-	-	-	-	-	-	-	-	-	-	-	-	-	-	-	-	-	-	-	-	
	4MXS100AA	-	-	-	-	-	-	-	-	-	-	-	-	-	-	-	-	-	-	-	-	-	-	-	-	-	-	-	-			
	4MXS115HV2C	-	-	-	-	-	-	-	-	-	-	-	-	-	-	-	-	-	-	-	-	-	-	-	-	-	-	-	-			
	Freestanding Washing Machine 洗衣機	Miele	WED 125	-	-	-	-	-	-	-	-	-	-	✓	-	-	-	-	-	-	-	-	-	-	-	-	-	-	-	-		
	Heat Pump Tumble Dryer 乾衣機	Miele	TEB 145 WP	-	-	-	-	-	-	-	-	-	-	✓	-	-	-	-	-	-	-	-	-	-	-	-	-	-	-	-		

The vendor undertakes that if lifts or appliances of the specified brand name or model number are not installed in the Phase, lifts or appliances of comparable quality will be installed.

Remarks :

- “✓” means such appliance(s) is / are provided and / or installed in the residential property.
- “-” denotes “not applicable”.
- 13/F, 14/F, 24/F, 34/F, 44/F and 54/F are omitted.

賣方承諾如期數中沒有安裝指明的品牌名稱或產品型號的升降機或設備，便會安裝品質相若的升降機或設備。

備註：

- “✓” 表示此設備於該住宅物業內提供及/或安裝。
- “-” 代表 “不適用”。
- 不設13樓、14樓、24樓、34樓、44樓及54樓。

Fittings, finishes and appliances

裝置、裝修物料及設備

Appliances Schedule 設備說明表

Location 位置	Appliance 設備	Brand Name 品牌名稱	Model No. 產品型號	Tower 6 (6A) 第6座 (6A)												Tower 6 (6B) 第6座 (6B)																
				7/F-12/F, 15/F-16/F, 18/F-23/F, 25/F-33/F & 35/F-39/F 7樓至12樓, 15樓至16樓, 18樓至23樓, 25樓至33樓 及35樓至39樓					41/F-43/F, 45/F-53/F & 55/F-61/F 41樓至43樓, 45樓至53樓及 55樓至61樓					62/F 62樓		7/F-12/F, 15/F-16/F, 18/F-23/F, 25/F-33/F & 35/F-39/F 7樓至12樓, 15樓至16樓, 18樓至23樓, 25樓至33樓 及35樓至39樓					41/F-43/F, 45/F-53/F & 55/F-61/F 41樓至43樓, 45樓至53樓及 55樓至61樓					62/F 62樓						
				A	B	C	D	E	A	B	C	D	E	A	C	D	E	A	C	D	E	F	A	C	E	F	A	C	E	F		
Open Kitchen/ Dining room/ Corridor 開放式廚房 / 飯廳 / 走廊	Electric Water Heater 電熱水爐	Stiebel Eltron 斯寶亞創	DHB 27 STi	-	-	-	-	-	-	-	-	-	-	-	-	-	-	-	-	✓	-	-	-	-	-	-	-	-	-	-	-	-
Open Kitchen 開放式廚房	Domino 2-zone Induction Hob 嵌入式雙頭電磁爐	Siemens 西門子	EH375FBB1E	-	-	-	-	-	-	-	-	-	-	-	-	-	-	-	-	✓	✓	-	-	-	-	✓	-	-	-	✓	-	
	Built-in Microwave Oven with Grill 嵌入式微波爐	Siemens 西門子	BE634LGS1B	-	-	-	-	-	-	-	-	-	-	-	-	-	-	-	-	✓	-	-	-	-	-	-	-	-	-	-	-	
	Built-in 1 Door Refrigerator, Top Freezer 嵌入式雪櫃	Siemens 西門子	KI24LV20HK	-	-	-	-	-	-	-	-	-	-	-	-	-	-	-	-	✓	-	-	-	-	✓	-	-	-	-	✓	-	
	FlexInduction Plus Hob 60cm 嵌入式60厘米FlexInduction 電磁爐	Siemens 西門子	EX675LYC1E	-	-	✓	✓	✓	-	-	✓	✓	✓	-	✓	✓	✓	-	-	-	-	✓	-	-	-	✓	-	-	-	-	✓	
	Built-in Oven with Microwave 嵌入式微波焗爐	Siemens 西門子	CM656GBS1B	-	-	✓	✓	✓	-	-	✓	✓	✓	-	✓	✓	✓	-	-	-	✓	✓	-	-	✓	✓	-	-	-	✓	✓	
	60cm Telescopic Hood 60厘米拉趟式抽油煙機	Siemens 西門子	LI67SA530B	-	-	✓	✓	✓	-	-	✓	✓	✓	-	✓	✓	✓	-	-	✓	✓	✓	-	-	✓	✓	-	-	-	✓	✓	
	Built-in 2 Doors Refrigerator, Bottom Freezer 嵌入式雙門雪櫃	Siemens 西門子	KI86NAF31K	-	-	✓	✓	✓	-	-	✓	✓	✓	-	✓	✓	✓	-	-	-	-	✓	-	-	-	✓	-	-	-	-	✓	
	0.8m Built-in Refrigerator 0.8m 嵌入式雪櫃	Gorenje	RBIU6092AW	-	-	-	-	-	-	-	-	-	-	-	-	-	-	-	-	✓	-	-	-	-	-	-	-	-	-	-	-	

The vendor undertakes that if lifts or appliances of the specified brand name or model number are not installed in the Phase, lifts or appliances of comparable quality will be installed.

Remarks :

1. "✓" means such appliance(s) is / are provided and / or installed in the residential property.
2. "-" denotes "not applicable".
3. 13/F, 14/F, 24/F, 34/F, 44/F and 54/F are omitted.

賣方承諾如期數中沒有安裝指明的品牌名稱或產品型號的升降機或設備，便會安裝品質相若的升降機或設備。

備註：

1. "✓" 表示此設備於該住宅物業內提供及/或安裝。
2. "-" 代表 "不適用"。
3. 不設13樓、14樓、24樓、34樓、44樓及54樓。

Fittings, finishes and appliances

裝置、裝修物料及設備

Appliances Schedule 設備說明表

Location 位置	Appliance 設備	Brand Name 品牌名稱	Model No. 產品型號	Tower 6 (6A) 第6座 (6A)												Tower 6 (6B) 第6座 (6B)															
				7/F-12/F, 15/F-16/F, 18/F-23/F, 25/F-33/F & 35/F-39/F 7樓至12樓, 15樓至16樓, 18樓至23樓, 25樓至33樓 及35樓至39樓					41/F-43/F, 45/F-53/F & 55/F-61/F 41樓至43樓, 45樓至53樓及 55樓至61樓					62/F 62樓				7/F-12/F, 15/F-16/F, 18/F-23/F, 25/F-33/F & 35/F-39/F 7樓至12樓, 15樓至16樓, 18樓至23樓, 25樓至33樓 及35樓至39樓					41/F-43/F, 45/F-53/F & 55/F-61/F 41樓至43樓, 45樓至53樓及 55樓至61樓					62/F 62樓			
				A	B	C	D	E	A	B	C	D	E	A	C	D	E	A	C	D	E	F	A	C	E	F	A	C	E	F	
Bathroom 浴室	Electric Water Heater 電熱水爐	Stiebel Eltron 斯寶亞創	DHB 27 STi	-	-	✓	✓	-	-	-	✓	✓	-	-	✓	✓	-	-	-	-	✓	-	-	-	✓	-	-	-	✓	-	
	Gas Water Heater 煤氣熱水爐	TGC	TN JW221TFQL	-	-	-	-	-	-	-	-	-	-	-	-	-	-	-	-	-	-	-	-	-	-	-	-	-	-	-	
			TN JW161TFL	-	-	-	-	✓	-	-	-	-	✓	-	-	-	✓	-	-	-	-	✓	-	-	-	✓	-	-	-	✓	-
	Thermo-ventilator 浴室換氣暖風機	Panasonic 樂聲牌	FV-40BE2H	-	-	✓	✓	✓	-	-	✓	✓	✓	-	✓	✓	✓	-	✓	✓	✓	✓	-	-	✓	✓	-	-	✓	✓	
	Exhaust Fan 抽氣扇	Östberg 奧斯博格	LPK 125B1-c	-	-	✓	✓	✓	-	-	✓	✓	✓	-	✓	✓	✓	-	✓	✓	✓	✓	-	-	✓	✓	-	-	✓	✓	
Imasu 伊馬司		HAE13-15B2	-	-	-	-	-	-	-	-	-	-	-	-	-	-	-	-	-	-	-	-	-	-	-	-	-	-	-		
Built-in Washer Dryer 嵌入式洗衣乾衣機	Gorenje	WDI73121HK	-	-	✓	✓	✓	-	-	✓	✓	✓	-	✓	✓	✓	-	✓	✓	✓	✓	-	-	✓	✓	-	-	✓	✓		
Bathroom 1 浴室 1	Electric Water Heater 電熱水爐	Stiebel Eltron 斯寶亞創	DHB 27 STi	-	-	-	-	-	-	-	-	-	-	-	-	-	-	-	-	-	-	-	-	-	-	-	-	-	-		
	Gas Water Heater 煤氣熱水爐	TGC	TN JW221TFL	-	-	-	-	-	-	-	-	-	-	✓	-	-	-	-	-	-	-	-	-	-	-	-	-	-	-	-	
			TN JW221TFQL	-	-	-	-	-	-	-	-	-	-	-	✓	-	-	-	-	-	-	-	-	-	-	-	-	-	-	-	-
			TN JW161TFL	-	-	-	-	-	-	-	-	-	-	-	-	-	-	-	-	-	-	-	-	-	-	-	-	-	-	-	-
	Thermo-ventilator 浴室換氣暖風機	Panasonic 樂聲牌	FV-40BE2H	✓	✓	-	-	-	✓	✓	-	-	-	✓	-	-	-	✓	-	-	-	-	✓	✓	-	-	✓	✓	-	-	
Exhaust Fan 抽氣扇	Östberg 奧斯博格	LPK 125B1-c	-	-	-	-	-	-	-	-	-	-	✓	-	-	-	-	-	-	-	-	-	✓	-	-	-	✓	-	-		
	Imasu 伊馬司	HAE13-15B2	✓	✓	-	-	-	✓	✓	-	-	-	-	-	-	-	-	✓	-	-	-	-	✓	-	-	-	✓	-	-		

The vendor undertakes that if lifts or appliances of the specified brand name or model number are not installed in the Phase, lifts or appliances of comparable quality will be installed.

Remarks :

1. "✓" means such appliance(s) is / are provided and / or installed in the residential property.
2. "-" denotes "not applicable".
3. 13/F, 14/F, 24/F, 34/F, 44/F and 54/F are omitted.

賣方承諾如期數中沒有安裝指明的品牌名稱或產品型號的升降機或設備，便會安裝品質相若的升降機或設備。

備註：

1. "✓" 表示此設備於該住宅物業內提供及/或安裝。
2. "-" 代表 "不適用"。
3. 不設13樓、14樓、24樓、34樓、44樓及54樓。

Fittings, finishes and appliances

裝置、裝修物料及設備

Appliances Schedule 設備說明表

Location 位置	Appliance 設備	Brand Name 品牌名稱	Model No. 產品型號	Tower 6 (6A) 第6座 (6A)												Tower 6 (6B) 第6座 (6B)															
				7/F-12/F, 15/F-16/F, 18/F-23/F, 25/F-33/F & 35/F-39/F 7樓至12樓, 15樓至16樓, 18樓至23樓, 25樓至33樓 及35樓至39樓					41/F-43/F, 45/F-53/F & 55/F-61/F 41樓至43樓, 45樓至53樓及 55樓至61樓					62/F 62樓				7/F-12/F, 15/F-16/F, 18/F-23/F, 25/F-33/F & 35/F-39/F 7樓至12樓, 15樓至16樓, 18樓至23樓, 25樓至33樓 及35樓至39樓					41/F-43/F, 45/F-53/F & 55/F-61/F 41樓至43樓, 45樓至53樓及 55樓至61樓					62/F 62樓			
				A	B	C	D	E	A	B	C	D	E	A	C	D	E	A	C	D	E	F	A	C	E	F	A	C	E	F	
Bathroom 2 浴室 2	Electric Water Heater 電熱水爐	Stiebel Eltron 斯寶亞創	DHB 27 STi	-	-	-	-	-	-	-	-	-	-	-	-	-	-	-	-	-	-	-	-	-	-	-	-	-			
	Gas Water Heater 煤氣熱水爐	TGC	TN JW221TFQL	-	-	-	-	-	-	-	-	-	-	-	-	-	-	-	-	-	-	-	-	-	-	-	-	-			
			TN JW161TFL	-	-	-	-	-	-	-	-	-	-	-	-	-	-	-	-	-	-	-	-	-	-	-	-	-	-		
	Thermo-ventilator 浴室換氣暖風機	Panasonic 樂聲牌	FV-40BE2H	✓	✓	-	-	-	✓	✓	-	-	-	✓	-	-	-	✓	-	-	-	-	✓	✓	-	-	✓	✓	-	-	
	Exhaust Fan 抽氣扇	Östberg 奧斯博格	LPK 125B1-c	-	✓	-	-	-	-	✓	-	-	-	✓	-	-	-	-	-	-	-	-	✓	-	-	-	✓	-	-		
Imasu 伊馬司		HAE13-15B2	✓	-	-	-	-	✓	-	-	-	-	-	-	-	-	✓	-	-	-	-	✓	-	-	-	✓	-	-			
Built-in Washer Dryer 嵌入式洗衣乾衣機	Gorenje	WDI73121HK	✓	✓	-	-	-	✓	✓	-	-	-	-	-	-	-	✓	-	-	-	-	✓	✓	-	-	✓	✓	-	-		
Bathroom 3 浴室 3	Electric Water Heater 電熱水爐	Stiebel Eltron 斯寶亞創	DHB 27 STi	-	-	-	-	-	-	-	-	-	-	-	-	-	-	-	-	-	-	-	-	-	-	-	-	-			
	Gas Water Heater 煤氣熱水爐	TGC	TN JW221TFQL	-	-	-	-	-	-	-	-	-	-	-	-	-	-	-	-	-	-	-	-	-	-	-	-	-			
			TN JW161TFL	-	-	-	-	-	-	-	-	-	-	-	-	-	-	-	-	-	-	-	-	-	-	-	-	-	-		
	Thermo-ventilator 浴室換氣暖風機	Panasonic 樂聲牌	FV-40BE2H	-	-	-	-	-	-	-	-	-	-	✓	-	-	-	-	-	-	-	-	-	-	-	-	-	-			
	Exhaust Fan 抽氣扇	Östberg 奧斯博格	LPK 125B1-c	-	-	-	-	-	-	-	-	-	-	✓	-	-	-	-	-	-	-	-	-	-	-	-	-	-			
Imasu 伊馬司		HAE13-15B2	-	-	-	-	-	-	-	-	-	-	-	-	-	-	-	-	-	-	-	-	-	-	-	-	-				
Toilet 洗手間	Exhaust Fan 抽氣扇	Östberg 奧斯博格	LPK 125B1-c	-	-	-	-	-	-	-	-	-	-	✓	-	-	-	-	-	-	-	-	-	-	-	-	-				
		Imasu 伊馬司	HAE13-15B2	-	-	-	-	-	-	-	-	-	-	-	-	-	-	-	-	-	-	-	-	-	-	-	-	-			

The vendor undertakes that if lifts or appliances of the specified brand name or model number are not installed in the Phase, lifts or appliances of comparable quality will be installed.

Remarks :

1. "✓" means such appliance(s) is / are provided and / or installed in the residential property.
2. "-" denotes "not applicable".
3. 13/F, 14/F, 24/F, 34/F, 44/F and 54/F are omitted.

賣方承諾如期數中沒有安裝指明的品牌名稱或產品型號的升降機或設備，便會安裝品質相若的升降機或設備。

備註：

1. "✓" 表示此設備於該住宅物業內提供及/或安裝。
2. "-" 代表 "不適用"。
3. 不設13樓、14樓、24樓、34樓、44樓及54樓。

Fittings, finishes and appliances

裝置、裝修物料及設備

Appliances Schedule 設備說明表

Location 位置	Appliance 設備	Brand Name 品牌名稱	Model No. 產品型號	Tower 7 (7A) 第7座 (7A)										Tower 7 (7B) 第7座 (7B)											
				7/F-12/F, 15/F-16/F, 18/F-23/F, 25/F-33/F, 35/F-39/F, 41/F-43/F, 45/F-53/F & 55/F-61/F 7樓至12樓, 15樓至16樓, 18樓至23樓, 25樓至33樓, 35樓至39樓, 41樓至43樓, 45樓至53樓及55樓至61樓					62/F 62樓					7/F-12/F, 15/F-16/F, 18/F-23/F, 25/F-33/F, 35/F-39/F, 41/F-43/F, 45/F-53/F & 55/F-61/F 7樓至12樓, 15樓至16樓, 18樓至23樓, 25樓至33樓, 35樓至39樓, 41樓至43樓, 45樓至53樓及55樓至61樓					62/F 62樓						
				A	B	C	D	E	F	A	C	D	E	F	A	B	C	D	E	A	B	C	D		
Living Room/ Dining Room/ Master Bedroom/ Bedrooms 客廳 / 飯廳 / 主人睡房 / 睡房	Split-type Air-conditioner (Indoor Unit) 分體空調機 (室內機)	Daikin 大金	FTXS25EVMA8	-	-	-	-	-	-	-	-	-	-	-	-	-	-	-	-	-	-	-	-		
			FTXS35EVMA8	✓	✓	-	-	-	-	✓	-	-	-	-	-	-	-	-	✓	-	-	-	-	✓	
			FTXS50FVMA8	-	-	-	-	-	-	✓	-	-	-	-	✓	-	-	-	-	✓	-	-	-	✓	
			FTXS60FVMA8	✓	✓	✓	-	✓	-	-	✓	-	✓	-	-	-	-	✓	-	-	-	-	-	-	
			FTXS71FVMA8	-	-	-	-	-	-	✓	-	-	-	-	-	-	-	✓	-	-	-	-	-	✓	
			FTXS25EVMA	✓	✓	✓	-	-	-	-	✓	-	-	-	-	✓	✓	-	✓	✓	✓	✓	-	-	
			FDXS25CVMA	-	-	-	-	-	-	-	-	-	-	-	-	-	-	-	-	-	-	-	-	-	
			FTXS35EVMA	-	-	✓	✓	-	✓	✓	✓	✓	-	✓	-	✓	-	✓	-	-	✓	-	✓	-	✓
			FTXS50FVMA	-	-	-	-	-	-	-	-	-	-	-	-	✓	-	✓	-	-	✓	-	✓	-	-
			FTXS60FVMA	-	-	-	-	-	-	✓	-	-	-	-	-	-	-	-	-	-	-	-	-	-	
	FTXS71FVMA	-	-	-	✓	-	✓	-	-	✓	-	✓	-	✓	✓	✓	✓	-	-	✓	✓	✓	-		
	Split-type Air-conditioner (Outdoor Unit) 分體空調機 (室外機)	Daikin 大金	RXS25EBVMA	-	-	-	-	-	-	-	-	-	-	-	-	-	-	-	-	-	-	-	-		
			RXS35EBVMA	✓	✓	-	-	-	-	✓	-	-	-	-	-	-	-	-	✓	-	-	-	-	✓	
			RXS50FVMA	-	-	-	-	-	-	✓	-	-	-	-	✓	-	-	-	-	✓	-	-	-	✓	
			RXS60FVMA	✓	✓	✓	-	✓	-	-	✓	-	✓	-	-	-	-	-	✓	-	-	-	-	-	
			RXS71FVMA	-	-	-	-	-	-	✓	-	-	-	-	-	-	-	-	✓	-	-	-	-	✓	
			3MXS52EVMA	✓	✓	✓	-	-	-	✓	✓	-	-	-	✓	✓	-	✓	✓	✓	✓	✓	-	✓	
			4MXS80EVMA	-	-	-	-	-	-	-	-	-	-	-	-	-	-	-	-	-	-	-	-	-	
4MXS100AA			-	-	-	-	-	-	-	-	-	-	-	-	-	✓	✓	-	-	-	✓	✓	-		
4MXS115HV2C	-	-	-	✓	-	✓	✓	-	✓	-	✓	✓	✓	-	-	-	-	✓	-	-	-				
Living Room/ Dining Room 客廳 / 飯廳	Built-in Fridge-freezer 嵌入式雪櫃連冰箱	Miele	KFNS 37232 iD	-	-	-	-	-	-	✓	-	-	-	-	-	-	-	-	-	-	-	✓			
	Mastercool Wine Conditioning Unit Mastercool 酒櫃	Miele	KWT 2611 Vi	-	-	-	-	-	-	✓	-	-	-	-	-	-	-	-	-	-	-	✓			
	Coffee Machine 咖啡機	Miele	CVA 7440	-	-	-	-	-	-	✓	-	-	-	-	-	-	-	-	-	-	-	✓			
	Gourmet Warming Drawer 食物保溫櫃	Miele	ESW 7010	-	-	-	-	-	-	✓	-	-	-	-	-	-	-	-	-	-	-	✓			

The vendor undertakes that if lifts or appliances of the specified brand name or model number are not installed in the Phase, lifts or appliances of comparable quality will be installed.

Remarks :

1. "✓" means such appliance(s) is / are provided and / or installed in the residential property.
2. "-" denotes "not applicable".
3. 13/F, 14/F, 24/F, 34/F, 44/F and 54/F are omitted.

賣方承諾如期數中沒有安裝指明的品牌名稱或產品型號的升降機或設備，便會安裝品質相若的升降機或設備。

備註：

1. "✓" 表示此設備於該住宅物業內提供及/或安裝。
2. "-" 代表 "不適用"。
3. 不設13樓、14樓、24樓、34樓、44樓及54樓。

Fittings, finishes and appliances

裝置、裝修物料及設備

Appliances Schedule 設備說明表

Location 位置	Appliance 設備	Brand Name 品牌名稱	Model No. 產品型號	Tower 7 (7A) 第7座 (7A)										Tower 7 (7B) 第7座 (7B)											
				7/F-12/F, 15/F-16/F, 18/F-23/F, 25/F-33/F, 35/F-39/F, 41/F-43/F, 45/F-53/F & 55/F-61/F 7樓至12樓, 15樓至16樓, 18樓至23樓, 25樓至33樓, 35樓至39樓, 41樓至43樓, 45樓至53樓及55樓至61樓					62/F 62樓					7/F-12/F, 15/F-16/F, 18/F-23/F, 25/F-33/F, 35/F-39/F, 41/F-43/F, 45/F-53/F & 55/F-61/F 7樓至12樓, 15樓至16樓, 18樓至23樓, 25樓至33樓, 35樓至39樓, 41樓至43樓, 45樓至53樓及55樓至61樓					62/F 62樓						
				A	B	C	D	E	F	A	C	D	E	F	A	B	C	D	E	A	B	C	D		
Store 儲物房	Split-type Air-conditioner (Indoor Unit) 分體空調機 (室內機)	Daikin 大金	FTXS25EVMA8	-	-	-	-	-	-	-	-	-	-	-	-	-	-	-	-	-	-	-	-		
			FTXS35EVMA8	-	-	-	-	-	-	-	-	-	-	-	-	-	-	-	-	-	-	-	-	-	
			FTXS50FVMA8	-	-	-	-	-	-	-	-	-	-	-	-	-	-	-	-	-	-	-	-	-	
			FTXS60FVMA8	-	-	-	-	-	-	-	-	-	-	-	-	-	-	-	-	-	-	-	-	-	
			FTXS71FVMA8	-	-	-	-	-	-	-	-	-	-	-	-	-	-	-	-	-	-	-	-	-	
			FTXS25EVMA	-	-	-	-	-	-	-	-	-	-	-	-	-	-	✓	-	-	-	-	✓	-	-
			FDXS25CVMA	-	-	-	-	-	-	-	-	-	-	-	-	-	-	-	-	-	-	-	-	-	-
			FTXS35EVMA	-	-	-	-	-	-	-	-	-	-	-	-	-	-	-	-	-	-	-	-	-	-
			FTXS50FVMA	-	-	-	-	-	-	-	-	-	-	-	-	-	-	-	-	-	-	-	-	-	-
			FTXS60FVMA	-	-	-	-	-	-	-	-	-	-	-	-	-	-	-	-	-	-	-	-	-	-
	FTXS71FVMA	-	-	-	-	-	-	-	-	-	-	-	-	-	-	-	-	-	-	-	-	-	-		
	Split-type Air-conditioner (Outdoor Unit) 分體空調機 (室外機)	Daikin 大金	RXS25EBVMA	-	-	-	-	-	-	-	-	-	-	-	-	-	-	-	-	-	-	-	-	-	
			RXS35EBVMA	-	-	-	-	-	-	-	-	-	-	-	-	-	-	-	-	-	-	-	-	-	-
			RXS50FVMA	-	-	-	-	-	-	-	-	-	-	-	-	-	-	-	-	-	-	-	-	-	-
			RXS60FVMA	-	-	-	-	-	-	-	-	-	-	-	-	-	-	-	-	-	-	-	-	-	-
			RXS71FVMA	-	-	-	-	-	-	-	-	-	-	-	-	-	-	-	-	-	-	-	-	-	-
			3MXS52EVMA	-	-	-	-	-	-	-	-	-	-	-	-	-	-	-	-	-	-	-	-	-	-
			4MXS80EVMA	-	-	-	-	-	-	-	-	-	-	-	-	-	-	-	-	-	-	-	-	-	-
4MXS100AA			-	-	-	-	-	-	-	-	-	-	-	-	-	-	✓	-	-	-	-	✓	-	-	
4MXS115HV2C	-	-	-	-	-	-	-	-	-	-	-	-	-	-	-	-	-	-	-	-	-	-			

The vendor undertakes that if lifts or appliances of the specified brand name or model number are not installed in the Phase, lifts or appliances of comparable quality will be installed.

Remarks :

1. "✓" means such appliance(s) is / are provided and / or installed in the residential property.
2. "-" denotes "not applicable".
3. 13/F, 14/F, 24/F, 34/F, 44/F and 54/F are omitted.

賣方承諾如期數中沒有安裝指明的品牌名稱或產品型號的升降機或設備，便會安裝品質相若的升降機或設備。

備註：

1. "✓" 表示此設備於該住宅物業內提供及/或安裝。
2. "-" 代表 "不適用"。
3. 不設13樓、14樓、24樓、34樓、44樓及54樓。

Fittings, finishes and appliances

裝置、裝修物料及設備

Appliances Schedule 設備說明表

Location 位置	Appliance 設備	Brand Name 品牌名稱	Model No. 產品型號	Tower 7 (7A) 第7座 (7A)										Tower 7 (7B) 第7座 (7B)											
				7/F-12/F, 15/F-16/F, 18/F-23/F, 25/F-33/F, 35/F-39/F, 41/F-43/F, 45/F-53/F & 55/F-61/F 7樓至12樓, 15樓至16樓, 18樓至23樓, 25樓至33樓, 35樓至39樓, 41樓至43樓, 45樓至53樓及55樓至61樓					62/F 62樓					7/F-12/F, 15/F-16/F, 18/F-23/F, 25/F-33/F, 35/F-39/F, 41/F-43/F, 45/F-53/F & 55/F-61/F 7樓至12樓, 15樓至16樓, 18樓至23樓, 25樓至33樓, 35樓至39樓, 41樓至43樓, 45樓至53樓及55樓至61樓					62/F 62樓						
				A	B	C	D	E	F	A	C	D	E	F	A	B	C	D	E	A	B	C	D		
Kitchen 廚房	Split-type Air-conditioner (Indoor Unit) 分體空調機 (室內機)	Daikin 大金	FTXS25EVMA8	-	-	-	-	-	-	-	-	-	-	-	-	-	-	-	-	-	-	-	-	-	
			FTXS35EVMA8	-	-	-	-	-	-	-	-	-	-	-	-	-	-	-	-	-	-	-	-	-	-
			FTXS50FVMA8	-	-	-	-	-	-	-	-	-	-	-	-	-	-	-	-	-	-	-	-	-	-
			FTXS60FVMA8	-	-	-	-	-	-	-	-	-	-	-	-	-	-	-	-	-	-	-	-	-	-
			FTXS71FVMA8	-	-	-	-	-	-	-	-	-	-	-	-	-	-	-	-	-	-	-	-	-	-
			FTXS25EVMA	-	-	-	-	-	-	-	-	-	-	-	-	-	-	-	-	-	-	-	-	-	-
			FDXS35CVMA	-	-	-	-	-	-	-	✓	-	-	-	-	-	-	-	-	-	-	-	-	-	-
			FDXS50CVMA	-	-	-	-	-	-	-	-	-	-	-	-	-	-	-	-	-	-	-	-	-	✓
			FTXS35EVMA	-	-	-	-	-	-	-	-	-	-	-	-	-	-	-	-	-	-	-	-	-	-
			FTXS50FVMA	-	-	-	-	-	-	-	-	-	-	-	-	-	-	-	-	-	-	-	-	-	-
			FTXS60FVMA	-	-	-	-	-	-	-	-	-	-	-	-	-	-	-	-	-	-	-	-	-	-
			FTXS71FVMA	-	-	-	-	-	-	-	-	-	-	-	-	-	-	-	-	-	-	-	-	-	-
	Split-type Air-conditioner (Outdoor Unit) 分體空調機 (室外機)	Daikin 大金	RXS25EBVMA	-	-	-	-	-	-	-	-	-	-	-	-	-	-	-	-	-	-	-	-	-	
			RXS35EBVMA	-	-	-	-	-	-	-	-	-	-	-	-	-	-	-	-	-	-	-	-	-	
			RXS50FVMA	-	-	-	-	-	-	-	-	-	-	-	-	-	-	-	-	-	-	-	-	-	
			RXS60FVMA	-	-	-	-	-	-	-	-	-	-	-	-	-	-	-	-	-	-	-	-	-	
			RXS71FVMA	-	-	-	-	-	-	-	-	-	-	-	-	-	-	-	-	-	-	-	-	-	
			3MXS52EVMA	-	-	-	-	-	-	-	✓	-	-	-	-	-	-	-	-	-	-	-	-	-	✓
			4MXS80EVMA	-	-	-	-	-	-	-	-	-	-	-	-	-	-	-	-	-	-	-	-	-	-
			4MXS100AA	-	-	-	-	-	-	-	-	-	-	-	-	-	-	-	-	-	-	-	-	-	-
	4MXS115HV2C	-	-	-	-	-	-	-	-	-	-	-	-	-	-	-	-	-	-	-	-	-	-		
	Gas Water Heater 煤氣熱水爐	TGC	TN JW221TFQL	✓	✓	-	-	-	-	-	-	-	-	-	-	✓	✓	-	✓	-	✓	✓	-	-	
			TN JW161TFQL	-	-	-	-	-	-	-	-	-	-	-	-	-	-	-	-	✓	-	-	-	-	
			TN JW221TFL	-	-	-	-	-	-	-	-	-	-	-	-	-	-	-	-	-	-	-	-	-	
			TN JW161TFL	-	-	-	-	-	-	-	-	-	-	-	-	-	-	-	-	-	-	-	-	-	
	Exhaust Fan 抽氣扇	Östberg 奧斯博格	LPK 125B1-c	✓	✓	-	-	-	-	-	✓	-	-	-	-	✓	✓	-	-	-	✓	✓	-	✓	
		Imasu 伊馬司	HAE13-15B2	-	-	-	-	-	-	-	-	-	-	-	-	-	-	-	✓	✓	-	-	-	-	

The vendor undertakes that if lifts or appliances of the specified brand name or model number are not installed in the Phase, lifts or appliances of comparable quality will be installed.

Remarks :

1. "✓" means such appliance(s) is / are provided and / or installed in the residential property.
2. "-" denotes "not applicable".
3. 13/F, 14/F, 24/F, 34/F, 44/F and 54/F are omitted.

賣方承諾如期數中沒有安裝指明的品牌名稱或產品型號的升降機或設備，便會安裝品質相若的升降機或設備。

備註：

1. "✓" 表示此設備於該住宅物業內提供及/或安裝。
2. "-" 代表 "不適用"。
3. 不設13樓、14樓、24樓、34樓、44樓及54樓。

Fittings, finishes and appliances

裝置、裝修物料及設備

Appliances Schedule 設備說明表

Location 位置	Appliance 設備	Brand Name 品牌名稱	Model No. 產品型號	Tower 7 (7A) 第7座 (7A)										Tower 7 (7B) 第7座 (7B)									
				7/F-12/F, 15/F-16/F, 18/F-23/F, 25/F-33/F, 35/F-39/F, 41/F-43/F, 45/F-53/F & 55/F-61/F 7樓至12樓, 15樓至16樓, 18樓至23樓, 25樓至33樓, 35樓至39樓, 41樓至43樓, 45樓至53樓及55樓至61樓						62/F 62樓				7/F-12/F, 15/F-16/F, 18/F-23/F, 25/F-33/F, 35/F-39/F, 41/F-43/F, 45/F-53/F & 55/F-61/F 7樓至12樓, 15樓至16樓, 18樓至23樓, 25樓至33樓, 35樓至39樓, 41樓至43樓, 45樓至53樓及55樓至61樓						62/F 62樓			
				A	B	C	D	E	F	A	C	D	E	F	A	B	C	D	E	A	B	C	D
Kitchen 廚房	Gas Hob (2-burners) 雙頭氣體煮食爐	Miele	CS 1013-1	✓	✓	-	-	-	-	✓	-	-	-	-	✓	✓	-	✓	✓	✓	✓	-	✓
	Gas Hob (Wok Burner) 炒鑊氣體煮食爐	Miele	CS1018 G	✓	✓	-	-	-	-	✓	-	-	-	-	✓	✓	-	✓	✓	✓	✓	-	✓
	Built-in Oven with Microwave 嵌入式微波焗爐	Siemens 西門子	CM656GBS1B	-	-	-	-	-	-	-	-	-	-	-	-	✓	-	-	✓	-	✓	-	-
	Oven with Microwave 微波焗爐	Miele	H 7240 BM	✓	✓	-	-	-	-	✓	-	-	-	-	✓	-	-	✓	-	✓	-	-	✓
	Barbecue Grill 燒烤爐	Miele	CS 1312 BG	-	-	-	-	-	-	✓	-	-	-	-	-	-	-	-	-	-	-	-	✓
	Steam Oven 蒸爐	Miele	DG 7240	-	-	-	-	-	-	✓	-	-	-	-	-	-	-	-	-	-	-	-	✓
	90cm Telescopic Hood 90厘米拉趟式抽油煙機	Siemens 西門子	LI97SA530B	✓	✓	-	-	-	-	-	-	-	-	-	✓	✓	-	✓	✓	✓	✓	-	-
	Cooker Hood 抽油煙機	Miele	DA 4228 W	-	-	-	-	-	-	✓	-	-	-	-	-	-	-	-	-	-	-	-	✓
	Built-in 2 Doors Refrigerator, Bottom Freezer 嵌入式雙門雪櫃	Siemens 西門子	KI86NAF31K	✓	✓	-	-	-	-	-	-	-	-	-	✓	✓	-	✓	✓	✓	✓	-	-
	Built-in Fridge-freezer 嵌入式雪櫃連冰箱	Miele	KFNS 37232 iD	-	-	-	-	-	-	✓	-	-	-	-	-	-	-	-	-	-	-	-	✓

The vendor undertakes that if lifts or appliances of the specified brand name or model number are not installed in the Phase, lifts or appliances of comparable quality will be installed.

Remarks :

1. "✓" means such appliance(s) is / are provided and / or installed in the residential property.
2. "-" denotes "not applicable".
3. 13/F, 14/F, 24/F, 34/F, 44/F and 54/F are omitted.

賣方承諾如期數中沒有安裝指明的品牌名稱或產品型號的升降機或設備，便會安裝品質相若的升降機或設備。

備註：

1. "✓" 表示此設備於該住宅物業內提供及/或安裝。
2. "-" 代表 "不適用"。
3. 不設13樓、14樓、24樓、34樓、44樓及54樓。

Fittings, finishes and appliances

裝置、裝修物料及設備

Appliances Schedule 設備說明表

Location 位置	Appliance 設備	Brand Name 品牌名稱	Model No. 產品型號	Tower 7 (7A) 第7座 (7A)										Tower 7 (7B) 第7座 (7B)											
				7/F-12/F, 15/F-16/F, 18/F-23/F, 25/F-33/F, 35/F-39/F, 41/F-43/F, 45/F-53/F & 55/F-61/F 7樓至12樓, 15樓至16樓, 18樓至23樓, 25樓至33樓, 35樓至39樓, 41樓至43樓, 45樓至53樓及55樓至61樓						62/F 62樓				7/F-12/F, 15/F-16/F, 18/F-23/F, 25/F-33/F, 35/F-39/F, 41/F-43/F, 45/F-53/F & 55/F-61/F 7樓至12樓, 15樓至16樓, 18樓至23樓, 25樓至33樓, 35樓至39樓, 41樓至43樓, 45樓至53樓及55樓至61樓						62/F 62樓					
				A	B	C	D	E	F	A	C	D	E	F	A	B	C	D	E	A	B	C	D		
Utility Room 工作間	Split-type Air-conditioner (Indoor Unit) 分體空調機 (室內機)	Daikin 大金	FTXS25EVMA8	-	-	-	-	-	-	-	-	-	-	-	-	-	-	-	-	-	-	-	-		
			FTXS35EVMA8	-	-	-	-	-	-	-	-	-	-	-	-	-	-	-	-	-	-	-	-	-	-
			FTXS50FVMA8	-	-	-	-	-	-	-	-	-	-	-	-	-	-	-	-	-	-	-	-	-	-
			FTXS60FVMA8	-	-	-	-	-	-	-	-	-	-	-	-	-	-	-	-	-	-	-	-	-	-
			FTXS71FVMA8	-	-	-	-	-	-	-	-	-	-	-	-	-	-	-	-	-	-	-	-	-	-
			FTXS20DVMA	-	-	-	-	-	-	-	✓	-	-	-	-	-	-	-	-	-	-	-	-	-	✓
			FDXS25CVMA	-	-	-	-	-	-	-	-	-	-	-	-	-	-	-	-	-	-	-	-	-	-
			FTXS35EVMA	-	-	-	-	-	-	-	-	-	-	-	-	-	-	-	-	-	-	-	-	-	-
			FTXS50FVMA	-	-	-	-	-	-	-	-	-	-	-	-	-	-	-	-	-	-	-	-	-	-
			FTXS60FVMA	-	-	-	-	-	-	-	-	-	-	-	-	-	-	-	-	-	-	-	-	-	-
	FTXS71FVMA	-	-	-	-	-	-	-	-	-	-	-	-	-	-	-	-	-	-	-	-	-	-		
	Split-type Air-conditioner (Outdoor Unit) 分體空調機 (室外機)	Daikin 大金	RXS25EBVMA	-	-	-	-	-	-	-	-	-	-	-	-	-	-	-	-	-	-	-	-	-	
			RXS35EBVMA	-	-	-	-	-	-	-	-	-	-	-	-	-	-	-	-	-	-	-	-	-	-
			RXS50FVMA	-	-	-	-	-	-	-	-	-	-	-	-	-	-	-	-	-	-	-	-	-	-
			RXS60FVMA	-	-	-	-	-	-	-	-	-	-	-	-	-	-	-	-	-	-	-	-	-	-
			RXS71FVMA	-	-	-	-	-	-	-	-	-	-	-	-	-	-	-	-	-	-	-	-	-	-
			3MXS52EVMA	-	-	-	-	-	-	-	✓	-	-	-	-	-	-	-	-	-	-	-	-	-	✓
			4MXS80EVMA	-	-	-	-	-	-	-	-	-	-	-	-	-	-	-	-	-	-	-	-	-	-
			4MXS100AA	-	-	-	-	-	-	-	-	-	-	-	-	-	-	-	-	-	-	-	-	-	-
	4MXS115HV2C	-	-	-	-	-	-	-	-	-	-	-	-	-	-	-	-	-	-	-	-	-	-		
Freestanding Washing Machine 洗衣機	Miele	WED 125	-	-	-	-	-	-	-	✓	-	-	-	-	-	-	-	-	-	-	-	✓			
Heat Pump Tumble Dryer 乾衣機	Miele	TEB 145 WP	-	-	-	-	-	-	-	✓	-	-	-	-	-	-	-	-	-	-	-	✓			

The vendor undertakes that if lifts or appliances of the specified brand name or model number are not installed in the Phase, lifts or appliances of comparable quality will be installed.

Remarks :

1. "✓" means such appliance(s) is / are provided and / or installed in the residential property.
2. "-" denotes "not applicable".
3. 13/F, 14/F, 24/F, 34/F, 44/F and 54/F are omitted.

賣方承諾如期數中沒有安裝指明的品牌名稱或產品型號的升降機或設備，便會安裝品質相若的升降機或設備。

備註：

1. "✓" 表示此設備於該住宅物業內提供及/或安裝。
2. "-" 代表 "不適用"。
3. 不設13樓、14樓、24樓、34樓、44樓及54樓。

Fittings, finishes and appliances

裝置、裝修物料及設備

Appliances Schedule 設備說明表

Location 位置	Appliance 設備	Brand Name 品牌名稱	Model No. 產品型號	Tower 7 (7A) 第7座 (7A)										Tower 7 (7B) 第7座 (7B)									
				7/F-12/F, 15/F-16/F, 18/F-23/F, 25/F-33/F, 35/F-39/F, 41/F-43/F, 45/F-53/F & 55/F-61/F 7樓至12樓, 15樓至16樓, 18樓至23樓, 25樓至33樓, 35樓至39樓, 41樓至43樓, 45樓至53樓及55樓至61樓						62/F 62樓				7/F-12/F, 15/F-16/F, 18/F-23/F, 25/F-33/F, 35/F-39/F, 41/F-43/F, 45/F-53/F & 55/F-61/F 7樓至12樓, 15樓至16樓, 18樓至23樓, 25樓至33樓, 35樓至39樓, 41樓至43樓, 45樓至53樓及55樓至61樓						62/F 62樓			
				A	B	C	D	E	F	A	C	D	E	F	A	B	C	D	E	A	B	C	D
Open Kitchen/ Dining room/ Corridor 開放式廚房 / 飯廳 / 走廊	Electric Water Heater 電熱水爐	Stiebel Eltron 斯寶亞創	DHB 27 STi	-	-	-	-	✓	-	-	-	-	✓	-	-	-	-	-	-	-	-	-	-
	Domino 2-zone Induction Hob 嵌入式雙頭電磁爐	Siemens 西門子	EH375FBB1E	-	-	-	✓	✓	✓	-	-	✓	✓	✓	-	-	✓	-	-	-	-	✓	-
	Built-in Microwave Oven with Grill 嵌入式微波爐	Siemens 西門子	BE634RGS1B	-	-	-	-	✓	-	-	-	-	✓	-	-	-	-	-	-	-	-	-	-
	Built-in 1 Door Refrigerator, Top Freezer 嵌入式雪櫃	Siemens 西門子	KI24LV20HK	-	-	-	✓	-	✓	-	-	✓	-	✓	-	-	✓	-	-	-	-	✓	-
	FlexInduction Plus Hob 60cm 嵌入式60厘米FlexInduction電磁爐	Siemens 西門子	EX675LYC1E	-	-	✓	-	-	-	-	✓	-	-	-	-	-	-	-	-	-	-	-	-
	Built-in Oven with Microwave 嵌入式微波焗爐	Siemens 西門子	CM656GBS1B	-	-	✓	✓	-	✓	-	✓	✓	-	✓	-	-	✓	-	-	-	-	✓	-
	60cm Telescopic Hood 60厘米拉趟式抽油煙機	Siemens 西門子	LI67SA530B	-	-	✓	✓	✓	✓	-	✓	✓	✓	✓	-	-	✓	-	-	-	-	✓	-
	Built-in 2 Doors Refrigerator, Bottom Freezer 嵌入式雙門雪櫃	Siemens 西門子	KI86NAF31K	-	-	✓	-	-	-	-	✓	-	-	-	-	-	-	-	-	-	-	-	-
	0.8m Built-in Refrigerator 0.8m 嵌入式雪櫃	Gorenje	RBIU6092AW	-	-	-	-	✓	-	-	-	-	✓	-	-	-	-	-	-	-	-	-	-

The vendor undertakes that if lifts or appliances of the specified brand name or model number are not installed in the Phase, lifts or appliances of comparable quality will be installed.

Remarks :

1. "✓" means such appliance(s) is / are provided and / or installed in the residential property.
2. "-" denotes "not applicable".
3. 13/F, 14/F, 24/F, 34/F, 44/F and 54/F are omitted.

賣方承諾如期數中沒有安裝指明的品牌名稱或產品型號的升降機或設備，便會安裝品質相若的升降機或設備。

備註：

1. "✓" 表示此設備於該住宅物業內提供及/或安裝。
2. "-" 代表 "不適用"。
3. 不設13樓、14樓、24樓、34樓、44樓及54樓。

Fittings, finishes and appliances

裝置、裝修物料及設備

Appliances Schedule 設備說明表

Location 位置	Appliance 設備	Brand Name 品牌名稱	Model No. 產品型號	Tower 7 (7A) 第7座 (7A)										Tower 7 (7B) 第7座 (7B)										
				7/F-12/F, 15/F-16/F, 18/F-23/F, 25/F-33/F, 35/F-39/F, 41/F-43/F, 45/F-53/F & 55/F-61/F 7樓至12樓, 15樓至16樓, 18樓至23樓, 25樓至33樓, 35樓至39樓, 41樓至43樓, 45樓至53樓及55樓至61樓						62/F 62樓				7/F-12/F, 15/F-16/F, 18/F-23/F, 25/F-33/F, 35/F-39/F, 41/F-43/F, 45/F-53/F & 55/F-61/F 7樓至12樓, 15樓至16樓, 18樓至23樓, 25樓至33樓, 35樓至39樓, 41樓至43樓, 45樓至53樓及55樓至61樓						62/F 62樓				
				A	B	C	D	E	F	A	C	D	E	F	A	B	C	D	E	A	B	C	D	
Bathroom 浴室	Electric Water Heater 電熱水爐	Stiebel Eltron 斯寶亞創	DHB 27 STi	-	-	-	✓	-	✓	-	-	✓	-	✓	-	-	✓	-	-	-	-	✓	-	
	Gas Water Heater 煤氣熱水爐	TGC	TN JW221TFQL	-	-	-	-	-	-	-	-	-	-	-	-	-	-	-	-	-	-	-	-	
			TN JW161TFL	-	-	✓	-	-	-	-	-	-	✓	-	-	-	-	-	-	-	-	-	-	-
	Thermo-ventilator 浴室換氣暖風機	Panasonic 樂聲牌	FV-40BE2H	-	-	✓	✓	✓	✓	-	✓	✓	✓	✓	-	-	✓	-	✓	-	-	✓	-	
	Exhaust Fan 抽氣扇	Östberg 奧斯博格	LPK 125B1-c	-	-	✓	✓	✓	✓	-	✓	✓	✓	✓	-	-	✓	-	✓	-	-	✓	-	
Imasu 伊馬司		HAE13-15B2	-	-	-	-	-	-	-	-	-	-	-	-	-	-	-	-	-	-	-	-		
Built-in Washer Dryer 嵌入式洗衣乾衣機	Gorenje	WDI73121HK	-	-	✓	✓	✓	✓	-	✓	✓	✓	✓	-	-	✓	-	✓	-	-	✓	-		
Bathroom 1 浴室 1	Electric Water Heater 電熱水爐	Stiebel Eltron 斯寶亞創	DHB 27 STi	-	-	-	-	-	-	-	-	-	-	-	-	-	-	-	-	-	-	-		
	Gas Water Heater 煤氣熱水爐	TGC	TN JW221TFL	-	-	-	-	-	-	✓	-	-	-	-	-	-	-	-	-	-	-	-	✓	
			TN JW221TFQL	-	-	-	-	-	-	-	✓	-	-	-	-	-	-	-	-	-	-	-	-	✓
			TN JW161TFL	-	-	-	-	-	-	-	-	-	-	-	-	-	-	-	-	-	-	-	-	-
	Thermo-ventilator 浴室換氣暖風機	Panasonic 樂聲牌	FV-40BE2H	✓	✓	-	-	-	-	✓	-	-	-	-	✓	✓	-	✓	-	✓	✓	-	✓	
Exhaust Fan 抽氣扇	Östberg 奧斯博格	LPK 125B1-c	-	✓	-	-	-	-	✓	-	-	-	-	✓	✓	-	✓	-	✓	✓	-	✓		
	Imasu 伊馬司	HAE13-15B2	✓	-	-	-	-	-	-	-	-	-	-	-	-	-	-	-	-	-	-	-		

The vendor undertakes that if lifts or appliances of the specified brand name or model number are not installed in the Phase, lifts or appliances of comparable quality will be installed.

Remarks :

1. "✓" means such appliance(s) is / are provided and / or installed in the residential property.
2. "-" denotes "not applicable".
3. 13/F, 14/F, 24/F, 34/F, 44/F and 54/F are omitted.

賣方承諾如期數中沒有安裝指明的品牌名稱或產品型號的升降機或設備，便會安裝品質相若的升降機或設備。

備註：

1. "✓" 表示此設備於該住宅物業內提供及/或安裝。
2. "-" 代表 "不適用"。
3. 不設13樓、14樓、24樓、34樓、44樓及54樓。

Fittings, finishes and appliances

裝置、裝修物料及設備

Appliances Schedule 設備說明表

Location 位置	Appliance 設備	Brand Name 品牌名稱	Model No. 產品型號	Tower 7 (7A) 第7座 (7A)										Tower 7 (7B) 第7座 (7B)										
				7/F-12/F, 15/F-16/F, 18/F-23/F, 25/F-33/F, 35/F-39/F, 41/F-43/F, 45/F-53/F & 55/F-61/F 7樓至12樓, 15樓至16樓, 18樓至23樓, 25樓至33樓, 35樓至39樓, 41樓至43樓, 45樓至53樓及55樓至61樓						62/F 62樓				7/F-12/F, 15/F-16/F, 18/F-23/F, 25/F-33/F, 35/F-39/F, 41/F-43/F, 45/F-53/F & 55/F-61/F 7樓至12樓, 15樓至16樓, 18樓至23樓, 25樓至33樓, 35樓至39樓, 41樓至43樓, 45樓至53樓及55樓至61樓						62/F 62樓				
				A	B	C	D	E	F	A	C	D	E	F	A	B	C	D	E	A	B	C	D	
Bathroom 2 浴室 2	Electric Water Heater 電熱水爐	Stiebel Eltron 斯寶亞創	DHB 27 STi	-	-	-	-	-	-	-	-	-	-	-	-	-	-	-	-	-	-	-	-	
	Gas Water Heater 煤氣熱水爐	TGC	TN JW221TFQL	-	-	-	-	-	-	-	✓	-	-	-	-	-	-	-	-	-	-	-	-	
			TN JW161TFL	-	-	-	-	-	-	-	-	-	-	-	-	-	-	-	-	-	-	-	-	-
	Thermo-ventilator 浴室換氣暖風機	Panasonic 樂聲牌	FV-40BE2H	✓	✓	-	-	-	-	-	✓	-	-	-	-	✓	✓	-	✓	-	✓	✓	-	✓
	Exhaust Fan 抽氣扇	Östberg 奧斯博格	LPK 125B1-c	-	✓	-	-	-	-	-	✓	-	-	-	-	-	✓	-	✓	-	-	✓	-	✓
				Imasu 伊馬司	HAE13-15B2	✓	-	-	-	-	-	-	-	-	-	-	✓	-	-	-	-	✓	-	-
Built-in Washer Dryer 嵌入式洗衣乾衣機	Gorenje	WDI73121HK	✓	✓	-	-	-	-	-	-	-	-	-	-	✓	✓	-	✓	-	✓	✓	-	-	
Bathroom 3 浴室 3	Electric Water Heater 電熱水爐	Stiebel Eltron 斯寶亞創	DHB 27 STi	-	-	-	-	-	-	-	-	-	-	-	-	-	-	-	-	-	-	-	-	
	Gas Water Heater 煤氣熱水爐	TGC	TN JW221TFQL	-	-	-	-	-	-	-	-	-	-	-	-	-	-	-	-	-	-	-	-	
			TN JW161TFL	-	-	-	-	-	-	-	-	-	-	-	-	-	-	-	-	-	-	-	-	-
	Thermo-ventilator 浴室換氣暖風機	Panasonic 樂聲牌	FV-40BE2H	-	-	-	-	-	-	-	✓	-	-	-	-	-	-	-	-	-	-	-	-	
	Exhaust Fan 抽氣扇	Östberg 奧斯博格	LPK 125B1-c	-	-	-	-	-	-	-	✓	-	-	-	-	-	-	-	-	-	-	-	-	-
				Imasu 伊馬司	HAE13-15B2	-	-	-	-	-	-	-	-	-	-	-	-	-	-	-	-	-	-	-
Toilet 洗手間	Exhaust Fan 抽氣扇	Östberg 奧斯博格	LPK 125B1-c	-	-	-	-	-	-	-	-	-	-	-	-	-	-	-	-	-	-	-	✓	
		Imasu 伊馬司	HAE13-15B2	-	-	-	-	-	-	-	✓	-	-	-	-	-	-	-	-	-	-	-	-	-

The vendor undertakes that if lifts or appliances of the specified brand name or model number are not installed in the Phase, lifts or appliances of comparable quality will be installed.

Remarks :

1. "✓" means such appliance(s) is / are provided and / or installed in the residential property.
2. "-" denotes "not applicable".
3. 13/F, 14/F, 24/F, 34/F, 44/F and 54/F are omitted.

賣方承諾如期數中沒有安裝指明的品牌名稱或產品型號的升降機或設備，便會安裝品質相若的升降機或設備。

備註：

1. "✓" 表示此設備於該住宅物業內提供及/或安裝。
2. "-" 代表 "不適用"。
3. 不設13樓、14樓、24樓、34樓、44樓及54樓。

Service agreements

服務協議

Potable and flushing water is supplied by Water Supplies Department.

Electricity is supplied by CLP Power Hong Kong Limited.

Town gas is supplied by The Hong Kong and China Gas Company Limited.

食水及沖廁水由水務署供應。

電力由中華電力有限公司供應。

煤氣由香港中華煤氣有限公司供應。

Government rent

地稅

The vendor is liable for the Government rent payable for the specified residential property of the Phase up to and including the date of the respective assignment of the residential property to the purchaser.

賣方有法律責任就期數的指明住宅物業繳付直至並包括有關個別住宅物業之買方簽署轉讓契之日期為止的地稅。

Miscellaneous payments by purchaser

買方的雜項付款

1. On the delivery of the vacant possession of the specified residential property to the purchaser, the purchaser is liable to reimburse the owner for the deposits for water, electricity and gas.
2. On that delivery, the purchaser is not liable to pay to the owner a debris removal fee.

Remarks :

On that delivery, the purchaser is liable to pay a debris removal fee to the manager (not the owner) under the deed of mutual covenant, and where the owner has paid that debris removal fee, the purchaser shall reimburse the owner for the same.

1. 在向買方交付指明住宅物業在空置情況下的管有權時，買方須負責向擁有人補還水、電力及氣體的按金。
2. 在交付時，買方不須向擁有人支付清理廢料的費用。

備註：

在交付時，買方須根據公契向管理人(而非擁有人)支付清理廢料的費用，如擁有人已支付清理廢料的費用，買方須向擁有人補還清理廢料的費用。

Defect liability warranty period 欠妥之處的保養責任期

The vendor shall, at its own cost and as soon as reasonably practicable after receipt of a written notice served by the purchaser within 6 months after the date of completion of the sale and purchase of the residential property, remedy any defects to the residential property, or the fittings, finishes or appliances to be incorporated into the residential property as set out in the agreement for sale and purchase concerned, caused otherwise than by the act or neglect of the purchaser.

凡住宅物業或於買賣合約列出裝設於住宅物業內的裝置、裝修物料或設備有欠妥之處，而該欠妥之處並非由買方行為或疏忽造成，則賣方在接獲買方在買賣成交日期後的6個月內送達的書面通知後，須於合理地切實可行的範圍內，盡快自費作補救。

Maintenance of slopes

斜坡維修

1. The Land Grant requires the owners of the residential properties in the Phase to maintain slopes at their own cost.

Special Condition No. (54) of the Land Grant stipulates that:

"(a) Where there is or has been any cutting away, removal or setting back of any land, or any building-up or filling-in or any slope treatment works of any kind whatsoever, whether with or without the prior written consent of the Director, either within the lot or on any Government land, which is or was done for the purpose of or in connection with the formation, levelling or development of the lot or any part thereof or any other works required to be done by the Grantee under these Conditions, or for any other purpose, the Grantee shall at his own expense carry out and construct such slope treatment works, retaining walls or other support, protection, drainage or ancillary or other works as shall or may then or at any time thereafter be necessary to protect and support such land within the lot and also any adjacent or adjoining Government or leased land and to obviate and prevent any falling away, landslip or subsidence occurring thereafter. The Grantee shall at all times during the term hereby agreed to be granted maintain at his own expense the said land, slope treatment works, retaining walls or other support, protection, drainage or ancillary or other works in good and substantial repair and condition to the satisfaction of the Director.

(b) Nothing in sub-clause (a) of this Special Condition shall prejudice the Government's rights under these Conditions, in particular Special Condition No. (53) hereof.

(c) In the event that as a result of or arising out of any formation, levelling, development or other works done by the Grantee or owing to any other reason, any falling away, landslip or subsidence occurs at any time, whether in or from any land, within the lot or from any adjacent or adjoining Government or leased land, the Grantee shall at his own expense reinstate and make good the same to the satisfaction of the Director and shall indemnify the Government, its agents and contractors from and against all costs, charges, damages, demands and claims whatsoever which shall or may be made, suffered or incurred through or by reason of such falling away, landslip or subsidence.

(d) In addition to any other rights or remedies herein provided for breach of any of these Conditions, the Director shall be entitled by notice in writing to call upon the Grantee to carry out, construct and maintain the said land, slope treatment works, retaining walls, or other support, protection, and drainage or ancillary or other works or to reinstate and make good any falling away, landslip or subsidence, and if the Grantee shall neglect or fail to comply with the notice to the satisfaction of the Director within the period specified therein, the Director may forthwith execute and carry out any necessary works and the Grantee shall on demand repay to the Government the cost thereof, together with any administrative or professional fees and charges."

2. Each of the owners is obliged to contribute towards the costs of the maintenance work.
3. The plan showing the slopes and any retaining wall or related structures constructed, or to be constructed, within or outside the land on which the Phase is situated is set out on page 249.
4. Owner's undertaking to maintain any slope in relation to the Phase at the owner's own costs: Not applicable.
5. Under the deed of mutual covenant, the manager of the Phase has the owners' authority to carry out the maintenance work.

1. 批地文件規定，期數中的住宅物業的擁有人須自費維修斜坡。

批地文件第(54)條批地特別條款訂明：-

"(a) 如果任何土地已經或需要被削去、消除或後移或堆積，或建造或填土或進行任何類型的斜坡處理工程，不論是否經署長事先書面同意，亦不論是在該地段內或任何政府土地內，旨在或有關於構建、平整或開發該地段或其任何部份或承批人按批地文件條款需要進行的任何其他工程，或作任何其他用途，承批人須自費進行和建設該等斜坡處理工程、護土牆或其他承托物、保護物、排水或輔助工程或今後成為必要的其他工程，以便保護和承托該地段和任何毗鄰或毗連政府土地或已出租土地內的土地及避免和防止其後發生的任何倒塌、山泥傾瀉或地陷。承批人須於本文約定的批租年期內自費保養該土地、斜坡處理工程、護土牆或其他承托物、保護物、排水或輔助工程或其他工程使其處於良好修葺的狀態，以至署長滿意。

(b) 本批地特別條款(a)款之規定概毋損此等批地條款賦予政府的各項權利，其中特別以批地文件第(53)條批地特別條款所訂者為要。

(c) 倘若因為任何構建、平整、開發或承批人進行其他工程或任何其他原因而引起倒塌、山泥傾瀉或地陷，不論發生在或來自該地段內任何土地或任何毗鄰或毗連政府土地或已出租土地，承批人須自費進行修復至原狀以至署長滿意並對上述倒塌、山泥傾瀉或地陷引起、招致或造成政府、其代理及承辦商承受、遭受或產生的各種費用、收費、損害賠償、要求及申索作出彌償。

(d) 除了就違反批地文件的條款權利或補償外，署長有權發出書面通知承批人進行、建造及保養該土地、斜坡處理工程、護土牆或其他承托物、保護物及排水或輔助工程或其他工程或恢復與彌補任何倒塌、山泥傾瀉或地陷。又如承批人疏忽或不按照通知於通知指定期限內以署長滿意的方式採取措施，署長可即時執行及進行任何必要工程，承批人須在政府通知時償付相關的費用，以及任何行政或專業費用與收費。"

2. 每名擁有人均須分擔維修工程項目的費用。

3. 第249頁顯示斜坡及已經或將會在期數所位於的土地之內或之外建造的任何護土牆或有關構築物的圖則。

4. 擁有人自費就期數維修任何斜坡的承諾：不適用。

5. 根據公契，期數的管理人獲擁有人授權進行維修工程。

Maintenance of slopes
斜坡維修

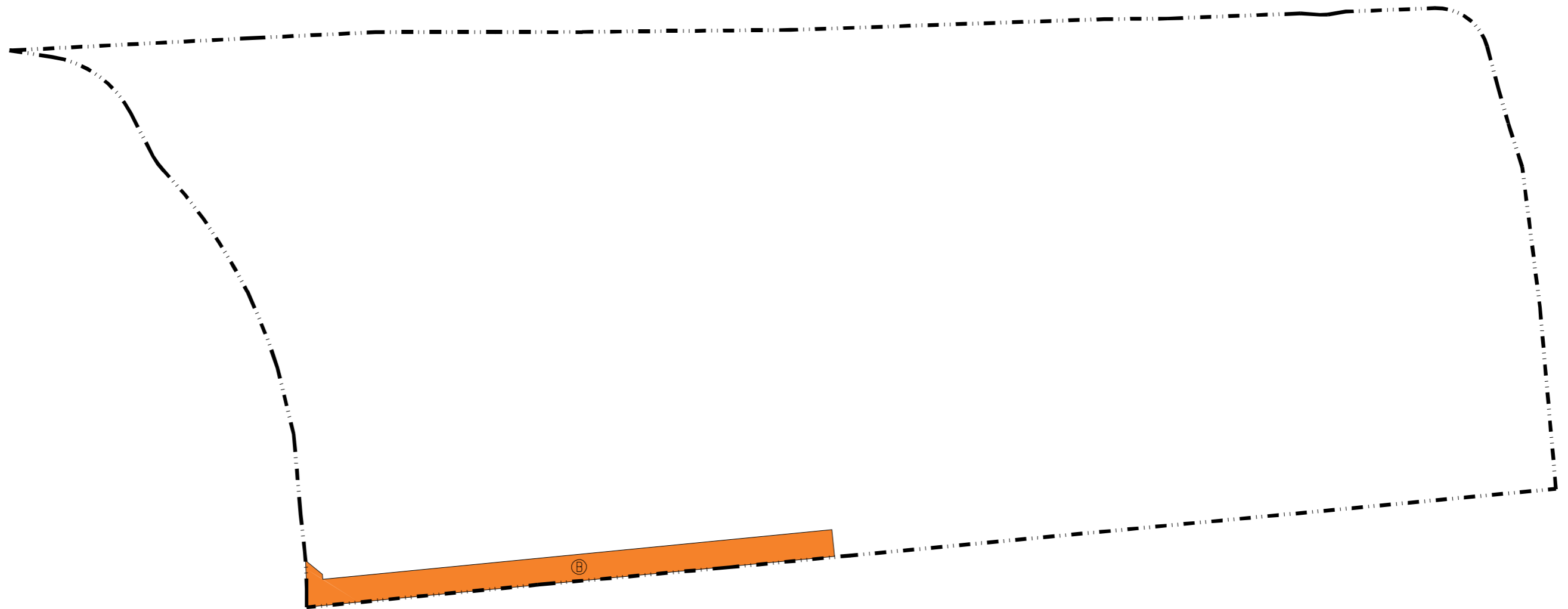
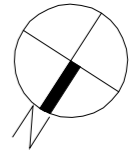

SCALE
比例 0 10 20 30 40m (米)

 Slopes and Retaining Structures
斜坡及護土結構

 Boundary Line of the Development
發展項目的界線

Modification
修訂

Not applicable

不適用

Relevant information

有關資料

Noise Mitigation Measures

紓緩噪音之措施

The following measures to mitigate road traffic noise impact from Che Kung Miu Road and Mei Tin Road are provided in the Phase:

- a) Fixed Glazing (with or without Maintenance Window) - the fixed glazing and maintenance window would be with glass pane, which are provided at selected residential properties. Therefore, noise would be reduced from entering into the rooms such that an acceptable indoor environment can be achieved. The maintenance windows need not be opened for ventilation and would only be opened occasionally for cleansing or maintenance. The maintenance window is only openable with a special key where necessary.
- b) Maintenance Window for Air-Conditioner (A/C) Platform - some habitable rooms are designed with maintenance windows near the A/C Platform, which are located in selected residential properties. For noise mitigation purpose, these maintenance windows will not be relied for ventilation purpose and are normally closed. They are only openable with special keys for maintenance of A/C where necessary.
- c) Acoustic Window (Baffle Type) - has an inner sliding glass panel behind an outer window, both readily openable, for creating an air gap for the supply of fresh air with noise mitigating effect, which are located in selected residential properties. It comprises two glazing – (i) the outer window system with side hung openable window and (ii) the inner sliding panel.
- d) Acoustic Balcony (Baffle Type) - has an inner sliding glass panel behind an outer door, both readily openable, for creating an air gap for the supply of fresh air with noise mitigating effect, which are located in selected residential properties. It comprises two glazing – (i) the outer door system with openable door and (ii) the inner sliding panel.
- e) Acoustic Utility Platform (Baffle Type) - has an inner sliding glass panel behind an outer door, both readily openable, for creating an air gap for the supply of fresh air with noise mitigation effect, which are located in selected residential properties. It comprises two glazing – (i) the outer door system with openable door and (ii) the inner sliding panel.
- f) Balcony with Acoustic Ceiling - Balcony with solid parapet are located in selected residential properties. The ceiling and soffit on top of the balcony will be applied with sound absorptive materials to minimize the potential noise reflection from the ceiling. Moreover, the noise would be shielded by the solid parapet of the balcony when the roads are located below.
- g) Solid Parapet erected at Transfer Plate (top level at 48.35 metres above the Hong Kong Principal Datum) - located in selected residential properties. The noise would be shielded by the solid parapet erected on the transfer plates, when the roads are located below.

Please refer to the table in this section of this sales brochure on pages 253 to 268 for details of the location of Fixed Glazing (with or without Maintenance Window), Maintenance Window for Air-Conditioner Platform, Acoustic Window (Baffle Type), Acoustic Window (Baffle Type) with Typical Balcony, Acoustic Balcony (Baffle Type), Acoustic Utility Platform (Baffle Type), Balcony with Acoustic Ceiling and Solid Parapet erected at Transfer Plate (top level at 48.35 metres above the Hong Kong Principal Datum).

Remarks:

Noise mitigation measures include Fixed Glazing (with or without Maintenance Window), Maintenance Window for Air-Conditioner Platform, Acoustic Window (Baffle Type), Acoustic Window (Baffle Type) with Typical Balcony, Acoustic Balcony (Baffle Type), Acoustic Utility Platform (Baffle Type), Balcony with Acoustic Ceiling and Solid Parapet erected at Transfer Plate (top level at 48.35 metres above the Hong Kong Principal Datum) applied to selected residential properties. No owner of residential properties shall make or permit or suffer to be made any alteration or conversion or modification of any Fixed Glazing (with or without Maintenance Window), Maintenance Window for Air-Conditioner Platform, Acoustic Window (Baffle Type), Acoustic Window (Baffle Type) with Typical Balcony, Acoustic Balcony (Baffle Type), Acoustic Utility Platform (Baffle Type), Balcony with Acoustic Ceiling and Solid Parapet erected at Transfer Plate (top level at 48.35 metres above the Hong Kong Principal Datum) without the prior written consent of the Building Authority and other relevant government authorities.

The height or top level of Solid Parapet indicated in the above description is the minimum level to be provided as noise mitigation measure.

In addition to the fixed glazing of noise mitigation measures, other non-noise mitigation measures fixed glazing may be installed at residential properties.

Relevant information 有關資料

Noise Mitigation Measures 紓緩噪音之措施

期數提供以下措施，以緩解車公廟路及美田路的道路交通噪音影響：

- a) 固定玻璃窗戶(配有或不配有維修用窗) - 配有玻璃的固定玻璃窗戶和維修用窗會在個別住宅物業提供。此窗戶可將傳播至室內的噪音減弱從而達到可接受的室內環境。維修用窗不能作通風之用及只能在作清潔或維修時開啓。維修用窗只能在必要時利用配備鎖匙開啓。
- b) 空調機平台維修用窗 - 在個別住宅物業內，可居住的房間旁的空調機平台會設有空調機平台維修用窗。維修用窗的用途是減低噪音，要常閉及不能作通風之用。它們只能在需要維修空調機時利用配備鎖匙開啓。
- c) 減音窗戶(擋音式) - 個別住宅物業的外層窗戶背面附有可滑動的內層嵌板，兩者都是可開啟的，當中的氣隙能用作供應新鮮空氣及可減弱室外噪音。減音窗戶(擋音式)由雙層玻璃組成 - (i) 配有可開啟的側吊窗的外層窗戶系統和(ii) 可滑動的內層嵌板。
- d) 減音露台(擋音式) - 個別住宅物業的外層落地玻璃門背面附有可滑動的內層嵌板，兩者都是可開啟的，當中的氣隙能用作供應新鮮空氣及可減弱室外噪音。減音露台(擋音式)由雙層玻璃組成 - (i) 配有可開啟的玻璃門的外層落地玻璃門系統和(ii) 可滑動的內層嵌板。
- e) 減音工作平台(擋音式) - 個別住宅物業的外層玻璃門背面附有可滑動的內層嵌板，兩者都是可開啟的，當中的氣隙能用作供應新鮮空氣及可減弱室外噪音。減音工作平台(擋音式)由雙層玻璃組成 - (i) 配有可開啟的玻璃門的外層落地玻璃門系統和(ii) 可滑動的內層嵌板。
- f) 配有減音天花的露台 - 個別住宅物業的露台配有密封圍欄。露台天花配有吸音物料將潛在由天花反射的噪音減少到最低限度。此外，露台的密封圍欄能阻隔從下方馬路所產生的噪音。
- g) 位於轉換層的密封圍欄(最高水平為香港主水平基準以上48.35米) - 個別住宅物業配有置於轉換層的密封圍欄。轉換層的密封圍欄能阻隔從下方馬路所產生的噪音。

有關裝設固定玻璃窗戶(配有或不配有維修用窗)、空調機平台維修用窗、減音窗戶(擋音式)、配有標準露台的減音窗戶(擋音式)、減音露台(擋音式)、減音工作平台(擋音式)、配有減音天花的露台或位於轉換層的密封圍欄(最高水平為香港主水平基準以上48.35米)位置的詳情，請參閱本售樓說明書本部分第253至268頁附表。

備註：

紓緩噪音之措施包括適用於個別住宅物業設置的固定玻璃窗戶(配有或不配有維修用窗)、空調機平台維修用窗、減音窗戶(擋音式)、配有標準露台的減音窗戶(擋音式)、減音露台(擋音式)、減音工作平台(擋音式)、配有減音天花的露台及位於轉換層的密封圍欄(最高水平為香港主水平基準以上48.35米)。除非獲得建築事務監督及/或其他政府有關當局的事先書面同意，住宅物業的業主不可作出或允許或忍受他人作出對固定玻璃窗戶(配有或不配有維修用窗)、空調機平台維修用窗、減音窗戶(擋音式)、配有標準露台的減音窗戶(擋音式)、減音露台(擋音式)、減音工作平台(擋音式)、配有減音天花的露台及位於轉換層的密封圍欄(最高水平為香港主水平基準以上48.35米)的任何改動或變更。

在以上描述的密封圍欄的高度或水平是作為紓緩噪音之措施的最低水平。

除紓緩噪音之措施的固定玻璃窗戶，住宅物業或有裝配非紓緩噪音之措施的固定玻璃窗戶。

Relevant information 有關資料

Noise Mitigation Measures

紓緩噪音之措施

Location of Fixed Glazing (with or without Maintenance Window), Maintenance Window for Air-Conditioner Platform, Acoustic Window (Baffle Type), Acoustic Balcony (Baffle Type), Acoustic Utility Platform (Baffle Type), Balcony with Acoustic Ceiling and Solid Parapet erected at Transfer Plate (Top level at 48.35 metres above the Hong Kong Principal Datum) at respective Residential Properties.

固定玻璃窗戶(配有或不配有維修用窗)、空調機平台維修用窗、減音窗戶(擋音式)、減音露台(擋音式)、減音工作平台(擋音式)、配有減音天花的露台及位於轉換層的密封圍欄(最高水平為香港主水平基準以上48.35米)於個別住宅物業的位置。

Tower 座號	Floor 樓層	Flat 單位	Fixed Glazing (with or without Maintenance Window) 固定玻璃窗戶(配有或不配有維修用窗)	Maintenance Window for Air-Conditioner Platform 空調機平台維修用窗	Acoustic Window (Baffle Type) 減音窗戶(擋音式)	Acoustic Balcony (Baffle Type) 減音露台 (擋音式)	Acoustic Utility Platform (Baffle Type) 減音工作平台 (擋音式)	Balcony with Acoustic Ceiling 配有減音天花的 露台	Solid Parapet erected at Transfer Plate (Top level at 48.35 metres above the Hong Kong Principal Datum) 位於轉換層的密封圍欄 (最高水平為香港主水平基 準以上48.35米)
Tower 5 (5A) 第5座 (5A)	7/F 7樓	A	Living Room, Bedroom 1, Bedroom 2, Master Bedroom 客廳、睡房1、睡房2、主人睡房	-	-	-	-	-	Flat Roof 平台
		B	Living Room, Bedroom 1, Master Bedroom 客廳、睡房1、主人睡房	Master Bedroom 主人睡房	-	-	-	-	Flat Roof 平台
		C	Living Room, Bedroom 1, Master Bedroom 客廳、睡房1、主人睡房	-	-	-	-	-	Flat Roof 平台
		D	-	-	-	-	-	-	Flat Roof 平台
		E	-	-	-	-	-	-	Flat Roof 平台
	8/F 8樓	A	Living Room, Bedroom 1, Bedroom 2, Master Bedroom 客廳、睡房1、睡房2、主人睡房	-	-	-	-	-	-
		B	Living Room, Bedroom 1, Master Bedroom 客廳、睡房1、主人睡房	Master Bedroom 主人睡房	Bedroom 1 睡房1	Living Room 客廳	Master Bedroom 主人睡房	-	-
		C	Living Room, Bedroom 1, Master Bedroom 客廳、睡房1、主人睡房	-	-	-	-	-	-
	9/F-10/F 9樓至10樓	A	Living Room, Bedroom 1, Bedroom 2, Master Bedroom 客廳、睡房1、睡房2、主人睡房	-	Bedroom 1, Bedroom 2 睡房1、睡房2	-	-	-	-
		B	Living Room, Bedroom 1, Master Bedroom 客廳、睡房1、主人睡房	Master Bedroom 主人睡房	Bedroom 1 睡房1	Living Room 客廳	Master Bedroom 主人睡房	-	-
		C	Living Room, Bedroom 1, Master Bedroom 客廳、睡房1、主人睡房	-	-	-	-	Living Room 客廳	-

Remarks:

- 13/F, 14/F, 24/F, 34/F, 44/F & 54/F of Tower 5 (5A & 5B) are omitted.
- 13/F, 14/F, 24/F, 34/F, 44/F & 54/F of Tower 6 (6A & 6B) are omitted.
- 13/F, 14/F, 24/F, 34/F, 44/F & 54/F of Tower 7 (7A & 7B) are omitted.
- The top level of Solid Parapet erected at Transfer Plate indicated in the above table is the minimum level to be provided as noise mitigation measure.
- In addition to the fixed glazing of noise mitigation measures, other non-noise mitigation measures fixed glazing may be installed at residential properties.

備註:

- 第5座(5A及5B)不設13樓、14樓、24樓、34樓、44樓及54樓。
- 第6座(6A及6B)不設13樓、14樓、24樓、34樓、44樓及54樓。
- 第7座(7A及7B)不設13樓、14樓、24樓、34樓、44樓及54樓。
- 上述表格所顯示位於轉換層的密封圍欄之最高水平為紓緩噪音之措施的最低下限。
- 除紓緩噪音之措施的固定玻璃窗戶，住宅物業或有裝配非紓緩噪音之措施的固定玻璃窗戶。

Relevant information 有關資料

Noise Mitigation Measures

紓緩噪音之措施

Location of Fixed Glazing (with or without Maintenance Window), Maintenance Window for Air-Conditioner Platform, Acoustic Window (Baffle Type), Acoustic Balcony (Baffle Type), Acoustic Utility Platform (Baffle Type), Balcony with Acoustic Ceiling and Solid Parapet erected at Transfer Plate (Top level at 48.35 metres above the Hong Kong Principal Datum) at respective Residential Properties.

固定玻璃窗戶(配有或不配有維修用窗)、空調機平台維修用窗、減音窗戶(擋音式)、減音露台(擋音式)、減音工作平台(擋音式)、配有減音天花的露台及位於轉換層的密封圍欄(最高水平為香港主水平基準以上48.35米)於個別住宅物業的位置。

Tower 座號	Floor 樓層	Flat 單位	Fixed Glazing (with or without Maintenance Window) 固定玻璃窗戶(配有或不配有維修用窗)	Maintenance Window for Air-Conditioner Platform 空調機平台維修用窗	Acoustic Window (Baffle Type) 減音窗戶(擋音式)	Acoustic Balcony (Baffle Type) 減音露台 (擋音式)	Acoustic Utility Platform (Baffle Type) 減音工作平台 (擋音式)	Balcony with Acoustic Ceiling 配有減音天花的 露台	Solid Parapet erected at Transfer Plate (Top level at 48.35 metres above the Hong Kong Principal Datum) 位於轉換層的密封圍欄 (最高水平為香港主水平基 準以上48.35米)
Tower 5 (5A) 第5座 (5A)	11/F-12/F and 15/F-16/F 11樓至12樓及 15樓至16樓	A	Living Room, Bedroom 1, Bedroom 2, Master Bedroom 客廳、睡房1、睡房2、主人睡房	-	Bedroom 1, Bedroom 2 睡房1、睡房2	Living Room 客廳	-	-	-
		B	Living Room, Bedroom 1, Master Bedroom 客廳、睡房1、主人睡房	Master Bedroom 主人睡房	Bedroom 1 睡房1	Living Room 客廳	Master Bedroom 主人睡房	-	-
		C	Living Room, Bedroom 1, Master Bedroom 客廳、睡房1、主人睡房	-	Bedroom 1 睡房1	-	-	Living Room 客廳	-
	18/F 18樓	A	Living Room, Bedroom 1, Bedroom 2, Master Bedroom 客廳、睡房1、睡房2、主人睡房	-	Bedroom 2 睡房2	-	-	-	-
		B	Living Room, Bedroom 1, Master Bedroom 客廳、睡房1、主人睡房	Master Bedroom 主人睡房	Bedroom 1 睡房1	Living Room 客廳	Master Bedroom 主人睡房	-	-
		C	Living Room, Bedroom 1, Master Bedroom 客廳、睡房1、主人睡房	-	Bedroom 1 睡房1	-	-	Living Room 客廳	-
	19/F-20/F 19樓至20樓	A	Living Room, Bedroom 1, Bedroom 2, Master Bedroom 客廳、睡房1、睡房2、主人睡房	-	-	-	-	-	-
		B	Living Room, Bedroom 1, Master Bedroom 客廳、睡房1、主人睡房	Master Bedroom 主人睡房	Bedroom 1 睡房1	Living Room 客廳	Master Bedroom 主人睡房	-	-
		C	Living Room, Bedroom 1, Master Bedroom 客廳、睡房1、主人睡房	-	Bedroom 1 睡房1	-	-	Living Room 客廳	-

Remarks:

- 13/F, 14/F, 24/F, 34/F, 44/F & 54/F of Tower 5 (5A & 5B) are omitted.
- 13/F, 14/F, 24/F, 34/F, 44/F & 54/F of Tower 6 (6A & 6B) are omitted.
- 13/F, 14/F, 24/F, 34/F, 44/F & 54/F of Tower 7 (7A & 7B) are omitted.
- The top level of Solid Parapet erected at Transfer Plate indicated in the above table is the minimum level to be provided as noise mitigation measure.
- In addition to the fixed glazing of noise mitigation measures, other non-noise mitigation measures fixed glazing may be installed at residential properties.

備註：

- 第5座(5A及5B)不設13樓、14樓、24樓、34樓、44樓及54樓。
- 第6座(6A及6B)不設13樓、14樓、24樓、34樓、44樓及54樓。
- 第7座(7A及7B)不設13樓、14樓、24樓、34樓、44樓及54樓。
- 上述表格所顯示位於轉換層的密封圍欄之最高水平為紓緩噪音之措施的最低下限。
- 除紓緩噪音之措施的固定玻璃窗戶，住宅物業或有裝配非紓緩噪音之措施的固定玻璃窗戶。

Relevant information 有關資料

Noise Mitigation Measures

紓緩噪音之措施

Location of Fixed Glazing (with or without Maintenance Window), Maintenance Window for Air-Conditioner Platform, Acoustic Window (Baffle Type), Acoustic Balcony (Baffle Type), Acoustic Utility Platform (Baffle Type), Balcony with Acoustic Ceiling and Solid Parapet erected at Transfer Plate (Top level at 48.35 metres above the Hong Kong Principal Datum) at respective Residential Properties.

固定玻璃窗戶(配有或不配有維修用窗)、空調機平台維修用窗、減音窗戶(擋音式)、減音露台(擋音式)、減音工作平台(擋音式)、配有減音天花的露台及位於轉換層的密封圍欄(最高水平為香港主水平基準以上48.35米)於個別住宅物業的位置。

Tower 座號	Floor 樓層	Flat 單位	Fixed Glazing (with or without Maintenance Window) 固定玻璃窗戶(配有或不配有維修用窗)	Maintenance Window for Air-Conditioner Platform 空調機平台維修用窗	Acoustic Window (Baffle Type) 減音窗戶(擋音式)	Acoustic Balcony (Baffle Type) 減音露台 (擋音式)	Acoustic Utility Platform (Baffle Type) 減音工作平台 (擋音式)	Balcony with Acoustic Ceiling 配有減音天花的 露台	Solid Parapet erected at Transfer Plate (Top level at 48.35 metres above the Hong Kong Principal Datum) 位於轉換層的密封圍欄 (最高水平為香港主水平基 準以上48.35米)
Tower 5 (5A) 第5座 (5A)	21/F-22/F 21樓至22樓	A	Living Room, Bedroom 1, Bedroom 2, Master Bedroom 客廳、睡房1、睡房2、主人睡房	-	-	-	-	-	-
		B	Living Room, Bedroom 1, Master Bedroom 客廳、睡房1、主人睡房	Master Bedroom 主人睡房	Bedroom 1 睡房1	Living Room 客廳	Master Bedroom 主人睡房	-	-
		C	Living Room, Bedroom 1, Master Bedroom 客廳、睡房1、主人睡房	-	-	-	-	Living Room 客廳	-
	23/F, 25/F-33F and 35/F-37/F 23樓、 25樓至33樓及 35樓至37樓	A	Living Room, Bedroom 1, Bedroom 2, Master Bedroom 客廳、睡房1、睡房2、主人睡房	-	-	-	-	-	-
		B	Living Room, Bedroom 1, Master Bedroom 客廳、睡房1、主人睡房	Master Bedroom 主人睡房	Bedroom 1 睡房1	Living Room 客廳	Master Bedroom 主人睡房	-	-
		C	Living Room, Bedroom 1, Master Bedroom 客廳、睡房1、主人睡房	-	-	-	-	-	-
	38/F-39/F, 41/F-43F and 45/F-47/F 38樓至39樓、 41樓至43樓及 45樓至47樓	A	Living Room, Bedroom 1, Bedroom 2, Master Bedroom 客廳、睡房1、睡房2、主人睡房	-	-	-	-	-	-
		B	Living Room, Bedroom 1, Master Bedroom 客廳、睡房1、主人睡房	Master Bedroom 主人睡房	Bedroom 1 睡房1	Living Room 客廳	-	-	-
		C	Living Room, Bedroom 1, Master Bedroom 客廳、睡房1、主人睡房	-	-	-	-	-	-

Remarks:

- 13/F, 14/F, 24/F, 34/F, 44/F & 54/F of Tower 5 (5A & 5B) are omitted.
- 13/F, 14/F, 24/F, 34/F, 44/F & 54/F of Tower 6 (6A & 6B) are omitted.
- 13/F, 14/F, 24/F, 34/F, 44/F & 54/F of Tower 7 (7A & 7B) are omitted.
- The top level of Solid Parapet erected at Transfer Plate indicated in the above table is the minimum level to be provided as noise mitigation measure.
- In addition to the fixed glazing of noise mitigation measures, other non-noise mitigation measures fixed glazing may be installed at residential properties.

備註：

- 第5座(5A及5B)不設13樓、14樓、24樓、34樓、44樓及54樓。
- 第6座(6A及6B)不設13樓、14樓、24樓、34樓、44樓及54樓。
- 第7座(7A及7B)不設13樓、14樓、24樓、34樓、44樓及54樓。
- 上述表格所顯示位於轉換層的密封圍欄之最高水平為紓緩噪音之措施的最低下限。
- 除紓緩噪音之措施的固定玻璃窗戶，住宅物業或有裝配非紓緩噪音之措施的固定玻璃窗戶。

Relevant information 有關資料

Noise Mitigation Measures

紓緩噪音之措施

Location of Fixed Glazing (with or without Maintenance Window), Maintenance Window for Air-Conditioner Platform, Acoustic Window (Baffle Type), Acoustic Balcony (Baffle Type), Acoustic Utility Platform (Baffle Type), Balcony with Acoustic Ceiling and Solid Parapet erected at Transfer Plate (Top level at 48.35 metres above the Hong Kong Principal Datum) at respective Residential Properties.

固定玻璃窗戶(配有或不配有維修用窗)、空調機平台維修用窗、減音窗戶(擋音式)、減音露台(擋音式)、減音工作平台(擋音式)、配有減音天花的露台及位於轉換層的密封圍欄(最高水平為香港主水平基準以上48.35米)於個別住宅物業的位置。

Tower 座號	Floor 樓層	Flat 單位	Fixed Glazing (with or without Maintenance Window) 固定玻璃窗戶(配有或不配有維修用窗)	Maintenance Window for Air-Conditioner Platform 空調機平台維修用窗	Acoustic Window (Baffle Type) 減音窗戶(擋音式)	Acoustic Balcony (Baffle Type) 減音露台 (擋音式)	Acoustic Utility Platform (Baffle Type) 減音工作平台 (擋音式)	Balcony with Acoustic Ceiling 配有減音天花的 露台	Solid Parapet erected at Transfer Plate (Top level at 48.35 metres above the Hong Kong Principal Datum) 位於轉換層的密封圍欄 (最高水平為香港主水平基 準以上48.35米)
Tower 5 (5A) 第5座 (5A)	48/F-53/F and 55/F 48樓至53樓 及55樓	A	Living Room, Bedroom 1, Bedroom 2, Master Bedroom 客廳、睡房1、睡房2、主人睡房	-	-	-	-	-	-
		B	Living Room, Bedroom 1, Master Bedroom 客廳、睡房1、主人睡房	Master Bedroom 主人睡房	Bedroom 1 睡房1	-	-	-	-
		C	Living Room, Bedroom 1, Master Bedroom 客廳、睡房1、主人睡房	-	-	-	-	-	-
	56/F-61/F 56樓至61樓	A	Living Room, Bedroom 1, Bedroom 2, Master Bedroom 客廳、睡房1、睡房2、主人睡房	-	-	-	-	-	-
		B	Living Room, Bedroom 1, Master Bedroom 客廳、睡房1、主人睡房	Master Bedroom 主人睡房	-	-	-	-	-
		C	Living Room, Bedroom 1, Master Bedroom 客廳、睡房1、主人睡房	-	-	-	-	-	-
	62/F 62樓	B	Bedroom 1 睡房1	Master Bedroom 主人睡房	Bedroom 1 睡房1	-	-	-	-

Remarks:

- 13/F, 14/F, 24/F, 34/F, 44/F & 54/F of Tower 5 (5A & 5B) are omitted.
- 13/F, 14/F, 24/F, 34/F, 44/F & 54/F of Tower 6 (6A & 6B) are omitted.
- 13/F, 14/F, 24/F, 34/F, 44/F & 54/F of Tower 7 (7A & 7B) are omitted.
- The top level of Solid Parapet erected at Transfer Plate indicated in the above table is the minimum level to be provided as noise mitigation measure.
- In addition to the fixed glazing of noise mitigation measures, other non-noise mitigation measures fixed glazing may be installed at residential properties.

備註：

- 第5座(5A及5B)不設13樓、14樓、24樓、34樓、44樓及54樓。
- 第6座(6A及6B)不設13樓、14樓、24樓、34樓、44樓及54樓。
- 第7座(7A及7B)不設13樓、14樓、24樓、34樓、44樓及54樓。
- 上述表格所顯示位於轉換層的密封圍欄之最高水平為紓緩噪音之措施的最低下限。
- 除紓緩噪音之措施的固定玻璃窗戶，住宅物業或有裝配非紓緩噪音之措施的固定玻璃窗戶。

Relevant information 有關資料

Noise Mitigation Measures

紓緩噪音之措施

Location of Fixed Glazing (with or without Maintenance Window), Maintenance Window for Air-Conditioner Platform, Acoustic Window (Baffle Type), Acoustic Balcony (Baffle Type), Acoustic Utility Platform (Baffle Type), Balcony with Acoustic Ceiling and Solid Parapet erected at Transfer Plate (Top level at 48.35 metres above the Hong Kong Principal Datum) at respective Residential Properties.

固定玻璃窗戶(配有或不配有維修用窗)、空調機平台維修用窗、減音窗戶(擋音式)、減音露台(擋音式)、減音工作平台(擋音式)、配有減音天花的露台及位於轉換層的密封圍欄(最高水平為香港主水平基準以上48.35米)於個別住宅物業的位置。

Tower 座號	Floor 樓層	Flat 單位	Fixed Glazing (with or without Maintenance Window) 固定玻璃窗戶(配有或不配有維修用窗)	Maintenance Window for Air-Conditioner Platform 空調機平台維修用窗	Acoustic Window (Baffle Type) 減音窗戶(擋音式)	Acoustic Balcony (Baffle Type) 減音露台 (擋音式)	Acoustic Utility Platform (Baffle Type) 減音工作平台 (擋音式)	Balcony with Acoustic Ceiling 配有減音天花的 露台	Solid Parapet erected at Transfer Plate (Top level at 48.35 metres above the Hong Kong Principal Datum) 位於轉換層的密封圍欄 (最高水平為香港主水平基 準以上48.35米)
Tower 5 (5B) 第5座 (5B)	7/F 7樓	A	Living Room, Bedroom 1, Bedroom 2, Master Bedroom 客廳、睡房1、睡房2、主人睡房	-	Bedroom 1 睡房1	-	-	-	Flat Roof 平台
		B	Living Room, Bedroom 1, Bedroom 2, Master Bedroom 客廳、睡房1、睡房2、主人睡房	-	-	-	-	-	Flat Roof 平台
		C	-	-	-	-	-	-	Flat Roof 平台
		D	-	-	-	-	-	-	Flat Roof 平台
	8/F-12/F, 15/F-16/F, 18/F-23/F and 25/F-32/F 8樓至12樓、 15樓至16樓、 18樓至23樓及 25樓至32樓	A	Living Room, Bedroom 1, Bedroom 2, Master Bedroom 客廳、睡房1、睡房2、主人睡房	-	Bedroom 1, Bedroom 2 睡房1、睡房2	Living Room 客廳	Master Bedroom 主人睡房	-	-
		B	Living Room, Bedroom 1, Bedroom 2, Master Bedroom 客廳、睡房1、睡房2、主人睡房	-	Bedroom 1, Bedroom 2, Master Bedroom 睡房1、睡房2、 主人睡房	Living Room 客廳	-	-	-
	33/F and 35/F-39/F 33樓及 35樓至39樓	A	Living Room, Bedroom 1, Bedroom 2, Master Bedroom 客廳、睡房1、睡房2、主人睡房	-	Bedroom 1, Bedroom 2 睡房1、睡房2	Living Room 客廳	-	-	-
		B	Living Room, Bedroom 1, Bedroom 2, Master Bedroom 客廳、睡房1、睡房2、主人睡房	-	Bedroom 1, Bedroom 2, Master Bedroom 睡房1、睡房2、 主人睡房	Living Room 客廳	-	-	-

Remarks:

- 13/F, 14/F, 24/F, 34/F, 44/F & 54/F of Tower 5 (5A & 5B) are omitted.
- 13/F, 14/F, 24/F, 34/F, 44/F & 54/F of Tower 6 (6A & 6B) are omitted.
- 13/F, 14/F, 24/F, 34/F, 44/F & 54/F of Tower 7 (7A & 7B) are omitted.
- The top level of Solid Parapet erected at Transfer Plate indicated in the above table is the minimum level to be provided as noise mitigation measure.
- In addition to the fixed glazing of noise mitigation measures, other non-noise mitigation measures fixed glazing may be installed at residential properties.

備註：

- 第5座(5A及5B)不設13樓、14樓、24樓、34樓、44樓及54樓。
- 第6座(6A及6B)不設13樓、14樓、24樓、34樓、44樓及54樓。
- 第7座(7A及7B)不設13樓、14樓、24樓、34樓、44樓及54樓。
- 上述表格所顯示位於轉換層的密封圍欄之最高水平為紓緩噪音之措施的最低下限。
- 除紓緩噪音之措施的固定玻璃窗戶，住宅物業或有裝配非紓緩噪音之措施的固定玻璃窗戶。

Relevant information 有關資料

Noise Mitigation Measures

紓緩噪音之措施

Location of Fixed Glazing (with or without Maintenance Window), Maintenance Window for Air-Conditioner Platform, Acoustic Window (Baffle Type), Acoustic Balcony (Baffle Type), Acoustic Utility Platform (Baffle Type), Balcony with Acoustic Ceiling and Solid Parapet erected at Transfer Plate (Top level at 48.35 metres above the Hong Kong Principal Datum) at respective Residential Properties.

固定玻璃窗戶(配有或不配有維修用窗)、空調機平台維修用窗、減音窗戶(擋音式)、減音露台(擋音式)、減音工作平台(擋音式)、配有減音天花的露台及位於轉換層的密封圍欄(最高水平為香港主水平基準以上48.35米)於個別住宅物業的位置。

Tower 座號	Floor 樓層	Flat 單位	Fixed Glazing (with or without Maintenance Window) 固定玻璃窗戶(配有或不配有維修用窗)	Maintenance Window for Air-Conditioner Platform 空調機平台維修用窗	Acoustic Window (Baffle Type) 減音窗戶(擋音式)	Acoustic Balcony (Baffle Type) 減音露台 (擋音式)	Acoustic Utility Platform (Baffle Type) 減音工作平台 (擋音式)	Balcony with Acoustic Ceiling 配有減音天花的 露台	Solid Parapet erected at Transfer Plate (Top level at 48.35 metres above the Hong Kong Principal Datum) 位於轉換層的密封圍欄 (最高水平為香港主水平基 準以上48.35米)
Tower 5 (5B) 第5座 (5B)	41/F-43/F and 45/F-47/F 41樓至43樓及 45樓至47樓	A	Living Room, Bedroom 1, Bedroom 2, Master Bedroom 客廳、睡房1、睡房2、主人睡房	-	Bedroom 1, Bedroom 2 睡房1、睡房2	Living Room 客廳	-	-	-
		B	Living Room, Bedroom 1, Bedroom 2, Master Bedroom 客廳、睡房1、睡房2、主人睡房	-	Bedroom 1, Bedroom 2, Master Bedroom 睡房1、睡房2、 主人睡房	-	-	-	-
	48/F-52/F 48樓至52樓	A	Living Room, Bedroom 1, Bedroom 2, Master Bedroom 客廳、睡房1、睡房2、主人睡房	-	Bedroom 1, Bedroom 2 睡房1、睡房2	-	-	-	-
		B	Living Room, Bedroom 1, Bedroom 2, Master Bedroom 客廳、睡房1、睡房2、主人睡房	-	Bedroom 1, Bedroom 2, Master Bedroom 睡房1、睡房2、 主人睡房	-	-	-	-
	53/F 53樓	A	Living Room, Bedroom 1, Bedroom 2, Master Bedroom 客廳、睡房1、睡房2、主人睡房	-	Bedroom 1, Bedroom 2 睡房1、睡房2	-	-	-	-
		B	Living Room, Bedroom 1, Bedroom 2, Master Bedroom 客廳、睡房1、睡房2、主人睡房	-	Bedroom 1, Bedroom 2 睡房1、睡房2	-	-	-	-
	55/F 55樓	A	Living Room, Bedroom 1, Bedroom 2, Master Bedroom 客廳、睡房1、睡房2、主人睡房	-	Bedroom 1 睡房1	-	-	-	-
		B	Living Room, Bedroom 1, Bedroom 2, Master Bedroom 客廳、睡房1、睡房2、主人睡房	-	Bedroom 1, Bedroom 2 睡房1、睡房2	-	-	-	-

Remarks:

- 13/F, 14/F, 24/F, 34/F, 44/F & 54/F of Tower 5 (5A & 5B) are omitted.
- 13/F, 14/F, 24/F, 34/F, 44/F & 54/F of Tower 6 (6A & 6B) are omitted.
- 13/F, 14/F, 24/F, 34/F, 44/F & 54/F of Tower 7 (7A & 7B) are omitted.
- The top level of Solid Parapet erected at Transfer Plate indicated in the above table is the minimum level to be provided as noise mitigation measure.
- In addition to the fixed glazing of noise mitigation measures, other non-noise mitigation measures fixed glazing may be installed at residential properties.

備註:

- 第5座(5A及5B)不設13樓、14樓、24樓、34樓、44樓及54樓。
- 第6座(6A及6B)不設13樓、14樓、24樓、34樓、44樓及54樓。
- 第7座(7A及7B)不設13樓、14樓、24樓、34樓、44樓及54樓。
- 上述表格所顯示位於轉換層的密封圍欄之最高水平為紓緩噪音之措施的最低下限。
- 除紓緩噪音之措施的固定玻璃窗戶，住宅物業或有裝配非紓緩噪音之措施的固定玻璃窗戶。

Relevant information

有關資料

Noise Mitigation Measures

紓緩噪音之措施

Location of Fixed Glazing (with or without Maintenance Window), Maintenance Window for Air-Conditioner Platform, Acoustic Window (Baffle Type), Acoustic Balcony (Baffle Type), Acoustic Utility Platform (Baffle Type), Balcony with Acoustic Ceiling and Solid Parapet erected at Transfer Plate (Top level at 48.35 metres above the Hong Kong Principal Datum) at respective Residential Properties.

固定玻璃窗戶(配有或不配有維修用窗)、空調機平台維修用窗、減音窗戶(擋音式)、減音露台(擋音式)、減音工作平台(擋音式)、配有減音天花的露台及位於轉換層的密封圍欄(最高水平為香港主水平基準以上48.35米)於個別住宅物業的位置。

Tower 座號	Floor 樓層	Flat 單位	Fixed Glazing (with or without Maintenance Window) 固定玻璃窗戶 (配有或不配有維修用窗)	Maintenance Window for Air-Conditioner Platform 空調機平台維修用窗	Acoustic Window (Baffle Type) 減音窗戶 (擋音式)	Acoustic Balcony (Baffle Type) 減音露台 (擋音式)	Acoustic Utility Platform (Baffle Type) 減音工作平台 (擋音式)	Balcony with Acoustic Ceiling 配有減音天花的 露台	Solid Parapet erected at Transfer Plate (Top level at 48.35 metres above the Hong Kong Principal Datum) 位於轉換層的密封圍欄 (最高水平為香港主水平基 準以上48.35米)
Tower 5 (5B) 第5座 (5B)	56/F 56樓	A	Living Room, Bedroom 1, Bedroom 2, Master Bedroom 客廳、睡房1、睡房2、主人睡房	-	-	-	-	-	-
		B	Living Room, Bedroom 1, Bedroom 2, Master Bedroom 客廳、睡房1、睡房2、主人睡房	-	Bedroom 1 睡房1	-	-	-	-
	57/F-61/F 57樓至61樓	A	Living Room, Bedroom 1, Bedroom 2, Master Bedroom 客廳、睡房1、睡房2、主人睡房	-	-	-	-	-	-
		B	Living Room, Bedroom 1, Bedroom 2, Master Bedroom 客廳、睡房1、睡房2、主人睡房	-	-	-	-	-	-

Remarks:

- 13/F, 14/F, 24/F, 34/F, 44/F & 54/F of Tower 5 (5A & 5B) are omitted.
- 13/F, 14/F, 24/F, 34/F, 44/F & 54/F of Tower 6 (6A & 6B) are omitted.
- 13/F, 14/F, 24/F, 34/F, 44/F & 54/F of Tower 7 (7A & 7B) are omitted.
- The top level of Solid Parapet erected at Transfer Plate indicated in the above table is the minimum level to be provided as noise mitigation measure.
- In addition to the fixed glazing of noise mitigation measures, other non-noise mitigation measures fixed glazing may be installed at residential properties.

備註：

- 第5座 (5A及5B)不設13樓、14樓、24樓、34樓、44樓及54樓。
- 第6座 (6A及6B)不設13樓、14樓、24樓、34樓、44樓及54樓。
- 第7座 (7A及7B)不設13樓、14樓、24樓、34樓、44樓及54樓。
- 上述表格所顯示位於轉換層的密封圍欄之最高水平為紓緩噪音之措施的最低下限。
- 除紓緩噪音之措施的固定玻璃窗戶，住宅物業或有裝配非紓緩噪音之措施的固定玻璃窗戶。

Relevant information 有關資料

Noise Mitigation Measures

紓緩噪音之措施

Location of Fixed Glazing (with or without Maintenance Window), Maintenance Window for Air-Conditioner Platform, Acoustic Window (Baffle Type), Acoustic Balcony (Baffle Type), Acoustic Utility Platform (Baffle Type), Balcony with Acoustic Ceiling and Solid Parapet erected at Transfer Plate (Top level at 48.35 metres above the Hong Kong Principal Datum) at respective Residential Properties.

固定玻璃窗戶(配有或不配有維修用窗)、空調機平台維修用窗、減音窗戶(擋音式)、減音露台(擋音式)、減音工作平台(擋音式)、配有減音天花的露台及位於轉換層的密封圍欄(最高水平為香港主水平基準以上48.35米)於個別住宅物業的位置。

Tower 座號	Floor 樓層	Flat 單位	Fixed Glazing (with or without Maintenance Window) 固定玻璃窗戶(配有或不配有維修用窗)	Maintenance Window for Air-Conditioner Platform 空調機平台維修用窗	Acoustic Window (Baffle Type) 減音窗戶(擋音式)	Acoustic Balcony (Baffle Type) 減音露台 (擋音式)	Acoustic Utility Platform (Baffle Type) 減音工作平台 (擋音式)	Balcony with Acoustic Ceiling 配有減音天花的 露台	Solid Parapet erected at Transfer Plate (Top level at 48.35 metres above the Hong Kong Principal Datum) 位於轉換層的密封圍欄 (最高水平為香港主水平基 準以上48.35米)
Tower 6 (6A) 第6座 (6A)	7/F 7樓	A	Living Room, Bedroom 1, Bedroom 2, Master Bedroom 客廳、睡房1、睡房2、主人睡房	-	-	-	-	-	Flat Roof 平台
		B	Living Room, Bedroom 1, Master Bedroom 客廳、睡房1、主人睡房	-	-	-	-	-	Flat Roof 平台
		C	-	-	-	-	-	-	Flat Roof 平台
		D	-	-	-	-	-	-	Flat Roof 平台
		E	-	-	-	-	-	-	Flat Roof 平台
	8/F -12/F, 15/F-16/F, 18/F-23/F and 25/F 8樓至12樓、 15樓至16樓、 18樓至23樓 及25樓	A	Living Room, Bedroom 1, Bedroom 2, Master Bedroom 客廳、睡房1、睡房2、主人睡房	-	Bedroom 1, Bedroom 2, Master Bedroom 睡房1、睡房2、 主人睡房	Living Room 客廳	-	-	-
		B	Living Room, Bedroom 1, Master Bedroom 客廳、睡房1、主人睡房	-	Bedroom 1 睡房1	Living Room 客廳	Master Bedroom 主人睡房	-	-
	26/F-33/F and 35/F 26樓至33樓 及35樓	A	Living Room, Bedroom 1, Bedroom 2, Master Bedroom 客廳、睡房1、睡房2、主人睡房	-	Bedroom 1, Bedroom 2, Master Bedroom 睡房1、睡房2、 主人睡房	Living Room 客廳	-	-	-
		B	Living Room, Bedroom 1, Master Bedroom 客廳、睡房1、主人睡房	-	Bedroom 1 睡房1	-	Master Bedroom 主人睡房	-	-

Remarks:

- 13/F, 14/F, 24/F, 34/F, 44/F & 54/F of Tower 5 (5A & 5B) are omitted.
- 13/F, 14/F, 24/F, 34/F, 44/F & 54/F of Tower 6 (6A & 6B) are omitted.
- 13/F, 14/F, 24/F, 34/F, 44/F & 54/F of Tower 7 (7A & 7B) are omitted.
- The top level of Solid Parapet erected at Transfer Plate indicated in the above table is the minimum level to be provided as noise mitigation measure.
- In addition to the fixed glazing of noise mitigation measures, other non-noise mitigation measures fixed glazing may be installed at residential properties.

備註：

- 第5座(5A及5B)不設13樓、14樓、24樓、34樓、44樓及54樓。
- 第6座(6A及6B)不設13樓、14樓、24樓、34樓、44樓及54樓。
- 第7座(7A及7B)不設13樓、14樓、24樓、34樓、44樓及54樓。
- 上述表格所顯示位於轉換層的密封圍欄之最高水平為紓緩噪音之措施的最低下限。
- 除紓緩噪音之措施的固定玻璃窗戶，住宅物業或有裝配非紓緩噪音之措施的固定玻璃窗戶。

Relevant information 有關資料

Noise Mitigation Measures

紓緩噪音之措施

Location of Fixed Glazing (with or without Maintenance Window), Maintenance Window for Air-Conditioner Platform, Acoustic Window (Baffle Type), Acoustic Balcony (Baffle Type), Acoustic Utility Platform (Baffle Type), Balcony with Acoustic Ceiling and Solid Parapet erected at Transfer Plate (Top level at 48.35 metres above the Hong Kong Principal Datum) at respective Residential Properties.

固定玻璃窗戶(配有或不配有維修用窗)、空調機平台維修用窗、減音窗戶(擋音式)、減音露台(擋音式)、減音工作平台(擋音式)、配有減音天花的露台及位於轉換層的密封圍欄(最高水平為香港主水平基準以上48.35米)於個別住宅物業的位置。

Tower 座號	Floor 樓層	Flat 單位	Fixed Glazing (with or without Maintenance Window) 固定玻璃窗戶(配有或不配有維修用窗)	Maintenance Window for Air-Conditioner Platform 空調機平台維修用窗	Acoustic Window (Baffle Type) 減音窗戶(擋音式)	Acoustic Balcony (Baffle Type) 減音露台 (擋音式)	Acoustic Utility Platform (Baffle Type) 減音工作平台 (擋音式)	Balcony with Acoustic Ceiling 配有減音天花的 露台	Solid Parapet erected at Transfer Plate (Top level at 48.35 metres above the Hong Kong Principal Datum) 位於轉換層的密封圍欄 (最高水平為香港主水平基 準以上48.35米)
Tower 6 (6A) 第6座 (6A)	36/F-39/F 36樓至39樓	A	Living Room, Bedroom 1, Bedroom 2, Master Bedroom 客廳、睡房1、睡房2、主人睡房	-	Bedroom 1, Bedroom 2, Master Bedroom 睡房1、睡房2、 主人睡房	Living Room 客廳	-	-	-
		B	Living Room, Bedroom 1, Master Bedroom 客廳、睡房1、主人睡房	-	Bedroom 1 睡房1	-	-	-	-
	41/F 41樓	A	Living Room, Bedroom 1, Bedroom 2, Master Bedroom 客廳、睡房1、睡房2、主人睡房	-	Bedroom 1, Bedroom 2, Master Bedroom 睡房1、睡房2、 主人睡房	Living Room 客廳	-	-	-
	42/F 42樓	A	Bedroom 1, Bedroom 2, Master Bedroom 睡房1、睡房2、主人睡房	-	Bedroom 1, Bedroom 2, Master Bedroom 睡房1、睡房2、 主人睡房	-	-	-	-

Remarks:

- 13/F, 14/F, 24/F, 34/F, 44/F & 54/F of Tower 5 (5A & 5B) are omitted.
- 13/F, 14/F, 24/F, 34/F, 44/F & 54/F of Tower 6 (6A & 6B) are omitted.
- 13/F, 14/F, 24/F, 34/F, 44/F & 54/F of Tower 7 (7A & 7B) are omitted.
- The top level of Solid Parapet erected at Transfer Plate indicated in the above table is the minimum level to be provided as noise mitigation measure.
- In addition to the fixed glazing of noise mitigation measures, other non-noise mitigation measures fixed glazing may be installed at residential properties.

備註：

- 第5座(5A及5B)不設13樓、14樓、24樓、34樓、44樓及54樓。
- 第6座(6A及6B)不設13樓、14樓、24樓、34樓、44樓及54樓。
- 第7座(7A及7B)不設13樓、14樓、24樓、34樓、44樓及54樓。
- 上述表格所顯示位於轉換層的密封圍欄之最高水平為紓緩噪音之措施的最低下限。
- 除紓緩噪音之措施的固定玻璃窗戶，住宅物業或有裝配非紓緩噪音之措施的固定玻璃窗戶。

Relevant information 有關資料

Noise Mitigation Measures

紓緩噪音之措施

Location of Fixed Glazing (with or without Maintenance Window), Maintenance Window for Air-Conditioner Platform, Acoustic Window (Baffle Type), Acoustic Balcony (Baffle Type), Acoustic Utility Platform (Baffle Type), Balcony with Acoustic Ceiling and Solid Parapet erected at Transfer Plate (Top level at 48.35 metres above the Hong Kong Principal Datum) at respective Residential Properties.

固定玻璃窗戶(配有或不配有維修用窗)、空調機平台維修用窗、減音窗戶(擋音式)、減音露台(擋音式)、減音工作平台(擋音式)、配有減音天花的露台及位於轉換層的密封圍欄(最高水平為香港主水平基準以上48.35米)於個別住宅物業的位置。

Tower 座號	Floor 樓層	Flat 單位	Fixed Glazing (with or without Maintenance Window) 固定玻璃窗戶(配有或不配有維修用窗)	Maintenance Window for Air-Conditioner Platform 空調機平台維修用窗	Acoustic Window (Baffle Type) 減音窗戶(擋音式)	Acoustic Balcony (Baffle Type) 減音露台 (擋音式)	Acoustic Utility Platform (Baffle Type) 減音工作平台 (擋音式)	Balcony with Acoustic Ceiling 配有減音天花的 露台	Solid Parapet erected at Transfer Plate (Top level at 48.35 metres above the Hong Kong Principal Datum) 位於轉換層的密封圍欄 (最高水平為香港主水平基 準以上48.35米)
Tower 6 (6B) 第6座 (6B)	7/F 7樓	A	Living Room, Bedroom 1, Bedroom 2, Master Bedroom 客廳、睡房1、睡房2、主人睡房	-	-	-	-	-	Flat Roof 平台
		C	-	-	-	-	-	-	Flat Roof 平台
		E	-	-	-	-	-	-	Flat Roof 平台
		F	-	-	-	-	-	-	Flat Roof 平台
	8/F -12/F, 15/F-16/F, 18/F-23/F, 25/F-33/F and 35/F-38/F 8樓至12樓、 15樓至16樓、 18樓至23樓、 25樓至33樓及 35樓至38樓	A	Living Room, Bedroom 1, Bedroom 2, Master Bedroom 客廳、睡房1、睡房2、主人睡房	-	Bedroom 1, Bedroom 2, Master Bedroom 睡房1、睡房2、 主人睡房	Living Room 客廳	-	-	-
39/F 39樓	A	Living Room, Bedroom 1, Bedroom 2, Master Bedroom 客廳、睡房1、睡房2、主人睡房	-	Bedroom 1, Bedroom 2, Master Bedroom 睡房1、睡房2、 主人睡房	-	-	-	-	
41/F 41樓	A	Living Room, Bedroom 1, Bedroom 2, Master Bedroom 客廳、睡房1、睡房2、主人睡房	-	Master Bedroom 主人睡房	-	-	-	-	

Remarks:

- 13/F, 14/F, 24/F, 34/F, 44/F & 54/F of Tower 5 (5A & 5B) are omitted.
- 13/F, 14/F, 24/F, 34/F, 44/F & 54/F of Tower 6 (6A & 6B) are omitted.
- 13/F, 14/F, 24/F, 34/F, 44/F & 54/F of Tower 7 (7A & 7B) are omitted.
- The top level of Solid Parapet erected at Transfer Plate indicated in the above table is the minimum level to be provided as noise mitigation measure.
- In addition to the fixed glazing of noise mitigation measures, other non-noise mitigation measures fixed glazing may be installed at residential properties.

備註：

- 第5座(5A及5B)不設13樓、14樓、24樓、34樓、44樓及54樓。
- 第6座(6A及6B)不設13樓、14樓、24樓、34樓、44樓及54樓。
- 第7座(7A及7B)不設13樓、14樓、24樓、34樓、44樓及54樓。
- 上述表格所顯示位於轉換層的密封圍欄之最高水平為紓緩噪音之措施的最低下限。
- 除紓緩噪音之措施的固定玻璃窗戶，住宅物業或有裝配非紓緩噪音之措施的固定玻璃窗戶。

Relevant information 有關資料

Noise Mitigation Measures

紓緩噪音之措施

Location of Fixed Glazing (with or without Maintenance Window), Maintenance Window for Air-Conditioner Platform, Acoustic Window (Baffle Type), Acoustic Balcony (Baffle Type), Acoustic Utility Platform (Baffle Type), Balcony with Acoustic Ceiling and Solid Parapet erected at Transfer Plate (Top level at 48.35 metres above the Hong Kong Principal Datum) at respective Residential Properties.

固定玻璃窗戶(配有或不配有維修用窗)、空調機平台維修用窗、減音窗戶(擋音式)、減音露台(擋音式)、減音工作平台(擋音式)、配有減音天花的露台及位於轉換層的密封圍欄(最高水平為香港主水平基準以上48.35米)於個別住宅物業的位置。

Tower 座號	Floor 樓層	Flat 單位	Fixed Glazing (with or without Maintenance Window) 固定玻璃窗戶(配有或不配有維修用窗)	Maintenance Window for Air-Conditioner Platform 空調機平台維修用窗	Acoustic Window (Baffle Type) 減音窗戶(擋音式)	Acoustic Balcony (Baffle Type) 減音露台 (擋音式)	Acoustic Utility Platform (Baffle Type) 減音工作平台 (擋音式)	Balcony with Acoustic Ceiling 配有減音天花的 露台	Solid Parapet erected at Transfer Plate (Top level at 48.35 metres above the Hong Kong Principal Datum) 位於轉換層的密封圍欄 (最高水平為香港主水平基 準以上48.35米)
Tower 7 (7A) 第7座 (7A)	7/F 7樓	A	Living Room, Bedroom 1, Bedroom 2, Master Bedroom 客廳、睡房1、睡房2、主人睡房	-	-	-	-	-	Flat Roof 平台
		B	Living Room, Bedroom 1, Bedroom 2, Master Bedroom 客廳、睡房1、睡房2、主人睡房	-	-	-	-	-	Flat Roof 平台
		C	-	-	-	-	-	-	Flat Roof 平台
		D	-	-	-	-	-	-	Flat Roof 平台
		F	-	-	-	-	-	-	Flat Roof 平台
	8/F 8樓	A	Living Room, Bedroom 1, Bedroom 2, Master Bedroom 客廳、睡房1、睡房2、主人睡房	-	Bedroom 1, Bedroom 2, Master Bedroom 睡房1、睡房2、 主人睡房	-	-	-	-
		B	Living Room, Bedroom 1, Bedroom 2, Master Bedroom 客廳、睡房1、睡房2、主人睡房	-	Bedroom 1, Bedroom 2 睡房1、睡房2	Living Room 客廳	-	-	-
	9/F -12/F, 15/F-16/F and 18/F-20/F 9樓至12樓、 15樓至16樓及 18樓至20樓	A	Living Room, Bedroom 1, Bedroom 2, Master Bedroom 客廳、睡房1、睡房2、主人睡房	-	Bedroom 1, Bedroom 2, Master Bedroom 睡房1、睡房2、 主人睡房	Living Room 客廳	-	-	-
		B	Living Room, Bedroom 1, Bedroom 2, Master Bedroom 客廳、睡房1、睡房2、主人睡房	-	Bedroom 1, Bedroom 2 睡房1、睡房2	Living Room 客廳	Master Bedroom 主人睡房	-	-

Remarks:

- 13/F, 14/F, 24/F, 34/F, 44/F & 54/F of Tower 5 (5A & 5B) are omitted.
- 13/F, 14/F, 24/F, 34/F, 44/F & 54/F of Tower 6 (6A & 6B) are omitted.
- 13/F, 14/F, 24/F, 34/F, 44/F & 54/F of Tower 7 (7A & 7B) are omitted.
- The top level of Solid Parapet erected at Transfer Plate indicated in the above table is the minimum level to be provided as noise mitigation measure.
- In addition to the fixed glazing of noise mitigation measures, other non-noise mitigation measures fixed glazing may be installed at residential properties.

備註：

- 第5座(5A及5B)不設13樓、14樓、24樓、34樓、44樓及54樓。
- 第6座(6A及6B)不設13樓、14樓、24樓、34樓、44樓及54樓。
- 第7座(7A及7B)不設13樓、14樓、24樓、34樓、44樓及54樓。
- 上述表格所顯示位於轉換層的密封圍欄之最高水平為紓緩噪音之措施的最低下限。
- 除紓緩噪音之措施的固定玻璃窗戶，住宅物業或有裝配非紓緩噪音之措施的固定玻璃窗戶。

Relevant information 有關資料

Noise Mitigation Measures

紓緩噪音之措施

Location of Fixed Glazing (with or without Maintenance Window), Maintenance Window for Air-Conditioner Platform, Acoustic Window (Baffle Type), Acoustic Balcony (Baffle Type), Acoustic Utility Platform (Baffle Type), Balcony with Acoustic Ceiling and Solid Parapet erected at Transfer Plate (Top level at 48.35 metres above the Hong Kong Principal Datum) at respective Residential Properties.

固定玻璃窗戶(配有或不配有維修用窗)、空調機平台維修用窗、減音窗戶(擋音式)、減音露台(擋音式)、減音工作平台(擋音式)、配有減音天花的露台及位於轉換層的密封圍欄(最高水平為香港主水平基準以上48.35米)於個別住宅物業的位置。

Tower 座號	Floor 樓層	Flat 單位	Fixed Glazing (with or without Maintenance Window) 固定玻璃窗戶(配有或不配有維修用窗)	Maintenance Window for Air-Conditioner Platform 空調機平台維修用窗	Acoustic Window (Baffle Type) 減音窗戶(擋音式)	Acoustic Balcony (Baffle Type) 減音露台 (擋音式)	Acoustic Utility Platform (Baffle Type) 減音工作平台 (擋音式)	Balcony with Acoustic Ceiling 配有減音天花的 露台	Solid Parapet erected at Transfer Plate (Top level at 48.35 metres above the Hong Kong Principal Datum) 位於轉換層的密封圍欄 (最高水平為香港主水平基 準以上48.35米)
Tower 7 (7A) 第7座 (7A)	21/F -23/F and 25/F-29/F 21樓至23樓及 25樓至29樓	A	Living Room, Bedroom 1, Bedroom 2, Master Bedroom 客廳、睡房1、睡房2、主人睡房	-	Bedroom 1, Bedroom 2, Master Bedroom 睡房1、睡房2、 主人睡房	Living Room 客廳	-	-	-
		B	Living Room, Bedroom 1, Bedroom 2, Master Bedroom 客廳、睡房1、睡房2、主人睡房	-	Bedroom 1, Bedroom 2 睡房1、睡房2	Living Room 客廳	-	-	-
	30/F-33/F, 35/F-39/F and 41/F 30樓至33樓、 35樓至39樓 及41樓	A	Living Room, Bedroom 1, Bedroom 2, Master Bedroom 客廳、睡房1、睡房2、主人睡房	-	Bedroom 1, Bedroom 2, Master Bedroom 睡房1、睡房2、 主人睡房	-	-	-	-
		B	Living Room, Bedroom 1, Bedroom 2, Master Bedroom 客廳、睡房1、睡房2、主人睡房	-	Bedroom 1, Bedroom 2 睡房1、睡房2	Living Room 客廳	-	-	-
	42/F-43/F 42樓至43樓	A	Living Room, Bedroom 1, Bedroom 2, Master Bedroom 客廳、睡房1、睡房2、主人睡房	-	Bedroom 1, Bedroom 2, Master Bedroom 睡房1、睡房2、 主人睡房	-	-	-	-
		B	Living Room, Bedroom 1, Bedroom 2, Master Bedroom 客廳、睡房1、睡房2、主人睡房	-	Bedroom 1, Bedroom 2 睡房1、睡房2	-	-	-	-

Remarks:

- 13/F, 14/F, 24/F, 34/F, 44/F & 54/F of Tower 5 (5A & 5B) are omitted.
- 13/F, 14/F, 24/F, 34/F, 44/F & 54/F of Tower 6 (6A & 6B) are omitted.
- 13/F, 14/F, 24/F, 34/F, 44/F & 54/F of Tower 7 (7A & 7B) are omitted.
- The top level of Solid Parapet erected at Transfer Plate indicated in the above table is the minimum level to be provided as noise mitigation measure.
- In addition to the fixed glazing of noise mitigation measures, other non-noise mitigation measures fixed glazing may be installed at residential properties.

備註：

- 第5座(5A及5B)不設13樓、14樓、24樓、34樓、44樓及54樓。
- 第6座(6A及6B)不設13樓、14樓、24樓、34樓、44樓及54樓。
- 第7座(7A及7B)不設13樓、14樓、24樓、34樓、44樓及54樓。
- 上述表格所顯示位於轉換層的密封圍欄之最高水平為紓緩噪音之措施的最低下限。
- 除紓緩噪音之措施的固定玻璃窗戶，住宅物業或有裝配非紓緩噪音之措施的固定玻璃窗戶。

Relevant information 有關資料

Noise Mitigation Measures

紓緩噪音之措施

Location of Fixed Glazing (with or without Maintenance Window), Maintenance Window for Air-Conditioner Platform, Acoustic Window (Baffle Type), Acoustic Balcony (Baffle Type), Acoustic Utility Platform (Baffle Type), Balcony with Acoustic Ceiling and Solid Parapet erected at Transfer Plate (Top level at 48.35 metres above the Hong Kong Principal Datum) at respective Residential Properties.

固定玻璃窗戶(配有或不配有維修用窗)、空調機平台維修用窗、減音窗戶(擋音式)、減音露台(擋音式)、減音工作平台(擋音式)、配有減音天花的露台及位於轉換層的密封圍欄(最高水平為香港主水平基準以上48.35米)於個別住宅物業的位置。

Tower 座號	Floor 樓層	Flat 單位	Fixed Glazing (with or without Maintenance Window) 固定玻璃窗戶(配有或不配有維修用窗)	Maintenance Window for Air-Conditioner Platform 空調機平台維修用窗	Acoustic Window (Baffle Type) 減音窗戶(擋音式)	Acoustic Balcony (Baffle Type) 減音露台 (擋音式)	Acoustic Utility Platform (Baffle Type) 減音工作平台 (擋音式)	Balcony with Acoustic Ceiling 配有減音天花的 露台	Solid Parapet erected at Transfer Plate (Top level at 48.35 metres above the Hong Kong Principal Datum) 位於轉換層的密封圍欄 (最高水平為香港主水平基 準以上48.35米)
Tower 7 (7A) 第7座 (7A)	45/F 45樓	A	Living Room, Bedroom 1, Bedroom 2, Master Bedroom 客廳、睡房1、睡房2、主人睡房	-	Bedroom 1, Bedroom 2 睡房1、睡房2	-	-	-	-
		B	Living Room, Bedroom 1, Bedroom 2, Master Bedroom 客廳、睡房1、睡房2、主人睡房	-	Bedroom 1, Bedroom 2 睡房1、睡房2	-	-	-	-
	46/F-47/F 46樓至47樓	A	Living Room, Bedroom 1, Bedroom 2, Master Bedroom 客廳、睡房1、睡房2、主人睡房	-	-	-	-	-	-
		B	Living Room, Bedroom 1, Bedroom 2, Master Bedroom 客廳、睡房1、睡房2、主人睡房	-	Bedroom 1, Bedroom 2 睡房1、睡房2	-	-	-	-
	48/F -53/F and 55/F-61/F 48樓至53樓及 55樓至61樓	A	Living Room, Bedroom 1, Bedroom 2, Master Bedroom 客廳、睡房1、睡房2、主人睡房	-	-	-	-	-	-
		B	Living Room, Bedroom 1, Bedroom 2, Master Bedroom 客廳、睡房1、睡房2、主人睡房	-	-	-	-	-	-
	62/F 62樓	A	Bedroom 1, Bedroom 2, Bedroom 3, Master Bedroom 睡房1、睡房2、睡房3、主人睡房	-	-	-	-	-	-

Remarks:

- 13/F, 14/F, 24/F, 34/F, 44/F & 54/F of Tower 5 (5A & 5B) are omitted.
- 13/F, 14/F, 24/F, 34/F, 44/F & 54/F of Tower 6 (6A & 6B) are omitted.
- 13/F, 14/F, 24/F, 34/F, 44/F & 54/F of Tower 7 (7A & 7B) are omitted.
- The top level of Solid Parapet erected at Transfer Plate indicated in the above table is the minimum level to be provided as noise mitigation measure.
- In addition to the fixed glazing of noise mitigation measures, other non-noise mitigation measures fixed glazing may be installed at residential properties.

備註：

- 第5座(5A及5B)不設13樓、14樓、24樓、34樓、44樓及54樓。
- 第6座(6A及6B)不設13樓、14樓、24樓、34樓、44樓及54樓。
- 第7座(7A及7B)不設13樓、14樓、24樓、34樓、44樓及54樓。
- 上述表格所顯示位於轉換層的密封圍欄之最高水平為紓緩噪音之措施的最低下限。
- 除紓緩噪音之措施的固定玻璃窗戶，住宅物業或有裝配非紓緩噪音之措施的固定玻璃窗戶。

Relevant information 有關資料

Noise Mitigation Measures

紓緩噪音之措施

Location of Fixed Glazing (with or without Maintenance Window), Maintenance Window for Air-Conditioner Platform, Acoustic Window (Baffle Type), Acoustic Balcony (Baffle Type), Acoustic Utility Platform (Baffle Type), Balcony with Acoustic Ceiling and Solid Parapet erected at Transfer Plate (Top level at 48.35 metres above the Hong Kong Principal Datum) at respective Residential Properties.

固定玻璃窗戶(配有或不配有維修用窗)、空調機平台維修用窗、減音窗戶(擋音式)、減音露台(擋音式)、減音工作平台(擋音式)、配有減音天花的露台及位於轉換層的密封圍欄(最高水平為香港主水平基準以上48.35米)於個別住宅物業的位置。

Tower 座號	Floor 樓層	Flat 單位	Fixed Glazing (with or without Maintenance Window) 固定玻璃窗戶(配有或不配有維修用窗)	Maintenance Window for Air-Conditioner Platform 空調機平台維修用窗	Acoustic Window (Baffle Type) 減音窗戶(擋音式)	Acoustic Balcony (Baffle Type) 減音露台 (擋音式)	Acoustic Utility Platform (Baffle Type) 減音工作平台 (擋音式)	Balcony with Acoustic Ceiling 配有減音天花的 露台	Solid Parapet erected at Transfer Plate (Top level at 48.35 metres above the Hong Kong Principal Datum) 位於轉換層的密封圍欄 (最高水平為香港主水平基 準以上48.35米)	
Tower 7 (7B) 第7座 (7B)	7/F 7樓	A	Living Room, Bedroom 1, Bedroom 2, Master Bedroom 客廳、睡房1、睡房2、主人睡房	-	-	-	-	-	Flat Roof 平台	
		B	Living Room, Bedroom 1, Master Bedroom 客廳、睡房1、主人睡房	-	-	-	-	-	Flat Roof 平台	
		C	Living Room, Master Bedroom 客廳、主人睡房	Master Bedroom 主人睡房	-	-	-	-	-	Flat Roof 平台
		D	-	-	-	-	-	-	-	Flat Roof 平台
		E	-	-	-	-	-	-	-	Flat Roof 平台
	8/F 8樓	A	Living Room, Bedroom 1, Bedroom 2, Master Bedroom 客廳、睡房1、睡房2、主人睡房	-	Bedroom 1, Bedroom 2 睡房1、睡房2	-	Master Bedroom 主人睡房	-	-	-
		B	Living Room, Bedroom 1, Master Bedroom 客廳、睡房1、主人睡房	-	Bedroom 1 睡房1	Living Room 客廳	Master Bedroom 主人睡房	-	-	-
		C	Living Room, Master Bedroom 客廳、主人睡房	Master Bedroom 主人睡房	-	-	-	-	-	-
	9/F -12/F, 15/F-16/F, 18/F-23/F and 25/F-31/F 9樓至12樓、 15樓至16樓、 18樓至23樓及 25樓至31樓	A	Living Room, Bedroom 1, Bedroom 2, Master Bedroom 客廳、睡房1、睡房2、主人睡房	-	Bedroom 1, Bedroom 2 睡房1、睡房2	Living Room 客廳	Master Bedroom 主人睡房	-	-	-
		B	Living Room, Bedroom 1, Master Bedroom 客廳、睡房1、主人睡房	-	Bedroom 1 睡房1	Living Room 客廳	Master Bedroom 主人睡房	-	-	-
		C	Living Room, Master Bedroom 客廳、主人睡房	Master Bedroom 主人睡房	Master Bedroom 主人睡房	-	-	Living Room 客廳	-	-

Remarks:

- 13/F, 14/F, 24/F, 34/F, 44/F & 54/F of Tower 5 (5A & 5B) are omitted.
- 13/F, 14/F, 24/F, 34/F, 44/F & 54/F of Tower 6 (6A & 6B) are omitted.
- 13/F, 14/F, 24/F, 34/F, 44/F & 54/F of Tower 7 (7A & 7B) are omitted.
- The top level of Solid Parapet erected at Transfer Plate indicated in the above table is the minimum level to be provided as noise mitigation measure.
- In addition to the fixed glazing of noise mitigation measures, other non-noise mitigation measures fixed glazing may be installed at residential properties.

備註：

- 第5座(5A及5B)不設13樓、14樓、24樓、34樓、44樓及54樓。
- 第6座(6A及6B)不設13樓、14樓、24樓、34樓、44樓及54樓。
- 第7座(7A及7B)不設13樓、14樓、24樓、34樓、44樓及54樓。
- 上述表格所顯示位於轉換層的密封圍欄之最高水平為紓緩噪音之措施的最低下限。
- 除紓緩噪音之措施的固定玻璃窗戶，住宅物業或有裝配非紓緩噪音之措施的固定玻璃窗戶。

Relevant information 有關資料

Noise Mitigation Measures

紓緩噪音之措施

Location of Fixed Glazing (with or without Maintenance Window), Maintenance Window for Air-Conditioner Platform, Acoustic Window (Baffle Type), Acoustic Balcony (Baffle Type), Acoustic Utility Platform (Baffle Type), Balcony with Acoustic Ceiling and Solid Parapet erected at Transfer Plate (Top level at 48.35 metres above the Hong Kong Principal Datum) at respective Residential Properties.

固定玻璃窗戶(配有或不配有維修用窗)、空調機平台維修用窗、減音窗戶(擋音式)、減音露台(擋音式)、減音工作平台(擋音式)、配有減音天花的露台及位於轉換層的密封圍欄(最高水平為香港主水平基準以上48.35米)於個別住宅物業的位置。

Tower 座號	Floor 樓層	Flat 單位	Fixed Glazing (with or without Maintenance Window) 固定玻璃窗戶(配有或不配有維修用窗)	Maintenance Window for Air-Conditioner Platform 空調機平台維修用窗	Acoustic Window (Baffle Type) 減音窗戶(擋音式)	Acoustic Balcony (Baffle Type) 減音露台 (擋音式)	Acoustic Utility Platform (Baffle Type) 減音工作平台 (擋音式)	Balcony with Acoustic Ceiling 配有減音天花的 露台	Solid Parapet erected at Transfer Plate (Top level at 48.35 metres above the Hong Kong Principal Datum) 位於轉換層的密封圍欄 (最高水平為香港主水平基 準以上48.35米)
Tower 7 (7B) 第7座 (7B)	32/F and 35/F 32樓及35樓	A	Living Room, Bedroom 1, Bedroom 2, Master Bedroom 客廳、睡房1、睡房2、主人睡房	-	Bedroom 1, Bedroom 2 睡房1、睡房2	Living Room 客廳	Master Bedroom 主人睡房	-	-
		B	Living Room, Bedroom 1, Master Bedroom 客廳、睡房1、主人睡房	-	Bedroom 1 睡房1	Living Room 客廳	-	-	-
		C	Living Room, Master Bedroom 客廳、主人睡房	Master Bedroom 主人睡房	Master Bedroom 主人睡房	-	-	Living Room 客廳	-
	36/F-39/F and 41/F 36樓至39樓 及41樓	A	Living Room, Bedroom 1, Bedroom 2, Master Bedroom 客廳、睡房1、睡房2、主人睡房	-	Bedroom 1, Bedroom 2 睡房1、睡房2	Living Room 客廳	Master Bedroom 主人睡房	-	-
		B	Living Room, Bedroom 1, Master Bedroom 客廳、睡房1、主人睡房	-	Bedroom 1 睡房1	Living Room 客廳	-	-	-
		C	Living Room, Master Bedroom 客廳、主人睡房	Master Bedroom 主人睡房	Master Bedroom 主人睡房	-	-	-	-
	42/F-43/F 42樓至43樓	A	Living Room, Bedroom 1, Bedroom 2, Master Bedroom 客廳、睡房1、睡房2、主人睡房	-	Bedroom 1, Bedroom 2 睡房1、睡房2	Living Room 客廳	Master Bedroom 主人睡房	-	-
		B	Living Room, Bedroom 1, Master Bedroom 客廳、睡房1、主人睡房	-	Bedroom 1 睡房1	Living Room 客廳	-	-	-
		C	Living Room, Master Bedroom 客廳、主人睡房	Master Bedroom 主人睡房	-	-	-	-	-

Remarks:

- 13/F, 14/F, 24/F, 34/F, 44/F & 54/F of Tower 5 (5A & 5B) are omitted.
- 13/F, 14/F, 24/F, 34/F, 44/F & 54/F of Tower 6 (6A & 6B) are omitted.
- 13/F, 14/F, 24/F, 34/F, 44/F & 54/F of Tower 7 (7A & 7B) are omitted.
- The top level of Solid Parapet erected at Transfer Plate indicated in the above table is the minimum level to be provided as noise mitigation measure.
- In addition to the fixed glazing of noise mitigation measures, other non-noise mitigation measures fixed glazing may be installed at residential properties.

備註：

- 第5座(5A及5B)不設13樓、14樓、24樓、34樓、44樓及54樓。
- 第6座(6A及6B)不設13樓、14樓、24樓、34樓、44樓及54樓。
- 第7座(7A及7B)不設13樓、14樓、24樓、34樓、44樓及54樓。
- 上述表格所顯示位於轉換層的密封圍欄之最高水平為紓緩噪音之措施的最低下限。
- 除紓緩噪音之措施的固定玻璃窗戶，住宅物業或有裝配非紓緩噪音之措施的固定玻璃窗戶。

Relevant information 有關資料

Noise Mitigation Measures

紓緩噪音之措施

Location of Fixed Glazing (with or without Maintenance Window), Maintenance Window for Air-Conditioner Platform, Acoustic Window (Baffle Type), Acoustic Balcony (Baffle Type), Acoustic Utility Platform (Baffle Type), Balcony with Acoustic Ceiling and Solid Parapet erected at Transfer Plate (Top level at 48.35 metres above the Hong Kong Principal Datum) at respective Residential Properties.

固定玻璃窗戶(配有或不配有維修用窗)、空調機平台維修用窗、減音窗戶(擋音式)、減音露台(擋音式)、減音工作平台(擋音式)、配有減音天花的露台及位於轉換層的密封圍欄(最高水平為香港主水平基準以上48.35米)於個別住宅物業的位置。

Tower 座號	Floor 樓層	Flat 單位	Fixed Glazing (with or without Maintenance Window) 固定玻璃窗戶(配有或不配有維修用窗)	Maintenance Window for Air-Conditioner Platform 空調機平台維修用窗	Acoustic Window (Baffle Type) 減音窗戶(擋音式)	Acoustic Balcony (Baffle Type) 減音露台 (擋音式)	Acoustic Utility Platform (Baffle Type) 減音工作平台 (擋音式)	Balcony with Acoustic Ceiling 配有減音天花的 露台	Solid Parapet erected at Transfer Plate (Top level at 48.35 metres above the Hong Kong Principal Datum) 位於轉換層的密封圍欄 (最高水平為香港主水平基 準以上48.35米)
Tower 7 (7B) 第7座 (7B)	45/F 45樓	A	Living Room, Bedroom 1, Bedroom 2, Master Bedroom 客廳、睡房1、睡房2、主人睡房	-	Bedroom 1, Bedroom 2 睡房1、睡房2	-	Master Bedroom 主人睡房	-	-
		B	Living Room, Bedroom 1, Master Bedroom 客廳、睡房1、主人睡房	-	Bedroom 1 睡房1	Living Room 客廳	-	-	-
		C	Living Room, Master Bedroom 客廳、主人睡房	Master Bedroom 主人睡房	-	-	-	-	-
	46/F 46樓	A	Living Room, Bedroom 1, Bedroom 2, Master Bedroom 客廳、睡房1、睡房2、主人睡房	-	Bedroom 1, Bedroom 2 睡房1、睡房2	-	Master Bedroom 主人睡房	-	-
		B	Living Room, Bedroom 1, Master Bedroom 客廳、睡房1、主人睡房	-	Bedroom 1 睡房1	-	-	-	-
		C	Living Room, Master Bedroom 客廳、主人睡房	Master Bedroom 主人睡房	-	-	-	-	-
	47/F -53/F and 55/F-61/F 47樓至53樓及 55樓至61樓	A	Living Room, Bedroom 1, Bedroom 2, Master Bedroom 客廳、睡房1、睡房2、主人睡房	-	Bedroom 1, Bedroom 2 睡房1、睡房2	-	Master Bedroom 主人睡房	-	-
		B	Living Room, Bedroom 1, Master Bedroom 客廳、睡房1、主人睡房	-	-	-	-	-	-
		C	Living Room, Master Bedroom 客廳、主人睡房	Master Bedroom 主人睡房	-	-	-	-	-
	62/F 62樓	A	Bedroom 1, Bedroom 2, Master Bedroom 睡房1、睡房2、主人睡房	-	Bedroom 1, Bedroom 2 睡房1、睡房2	-	-	-	-
		C	Living Room, Master Bedroom 客廳、主人睡房	Master Bedroom 主人睡房	-	-	-	-	-

Remarks:

- 13/F, 14/F, 24/F, 34/F, 44/F & 54/F of Tower 5 (5A & 5B) are omitted.
- 13/F, 14/F, 24/F, 34/F, 44/F & 54/F of Tower 6 (6A & 6B) are omitted.
- 13/F, 14/F, 24/F, 34/F, 44/F & 54/F of Tower 7 (7A & 7B) are omitted.
- The top level of Solid Parapet erected at Transfer Plate indicated in the above table is the minimum level to be provided as noise mitigation measure.
- In addition to the fixed glazing of noise mitigation measures, other non-noise mitigation measures fixed glazing may be installed at residential properties.

備註：

- 第5座(5A及5B)不設13樓、14樓、24樓、34樓、44樓及54樓。
- 第6座(6A及6B)不設13樓、14樓、24樓、34樓、44樓及54樓。
- 第7座(7A及7B)不設13樓、14樓、24樓、34樓、44樓及54樓。
- 上述表格所顯示位於轉換層的密封圍欄之最高水平為紓緩噪音之措施的最低下限。
- 除紓緩噪音之措施的固定玻璃窗戶，住宅物業或有裝配非紓緩噪音之措施的固定玻璃窗戶。

Address of the website designated by the vendor for the phase
賣方就期數指定的互聯網網站的網址

The address of the website designated by the vendor for the Phase for the purposes of Part 2 of the Residential Properties (First-hand Sales) Ordinance is: www.thepaviliafarm.com.hk/tpfii

賣方為施行《一手住宅物業銷售條例》第2部而就期數指定的互聯網網站的網址為：
www.thepaviliafarm.com.hk/tpfii

Information in application for concession on gross floor area of building

申請建築物總樓面面積寬免的資料

Breakdown of GFA Concessions Obtained for All Features

Latest information on breakdown of GFA concessions as shown on the general building plans submitted to and approved by the Building Authority (BA) prior to the printing of the sales brochure is tabulated below. Information marked (#) may be based on information provided by the authorized person if the sales brochure is printed prior to submission of the final amendment plans to the BA. The breakdown of GFA concessions may be subject to further changes until final amendment plans are submitted to and approved by the BA prior to the issuance of the occupation permit for the Phase.

獲寬免總樓面面積的設施分項

於印製售樓說明書前呈交予並已獲建築事務監督批准的一般建築圖則上有關總樓面面積寬免的分項的最新資料，請見下表。如印製售樓說明書時尚未呈交最終修訂圖則予建築事務監督，則有 (#) 號的資料可以由認可人士提供的資料作為基礎。直至最終修訂圖則於發出佔用許可證前呈交予並獲建築事務監督批准前，以下分項資料仍可能有所修改。

		Area (m ²) 面積 (平方米)
Disregarded GFA under Building (Planning) Regulations 23(3)(b) 根據《建築物(規劃)規例》第23(3)(b)條不計算的總樓面面積		
1.	Carpark and loading / unloading area excluding public transport terminus 停車場及上落客貨地方 (公共交通總站除外)	7,366.071 (Non-Domestic)(非住用)
2.	Plant rooms and similar services 機房及相類設施	
2.1	Mandatory feature or essential plant room, area of which is limited by respective Practice Notes for Authorized Persons, Registered Structural Engineers and Registered Geotechnical Engineers (PNAP) or regulation such as lift machine room, telecommunications and broadcasting (TBE) room, refuse storage and material recovery chamber, etc. 所佔面積受相關《認可人士、註冊結構工程師及註冊岩土工程師作業備考》或規例限制的強制性設施或必要機房，例如升降機機房、電訊及廣播設備室、垃圾及物料回收房等	889.405 (Domestic)(住用)
2.2	Mandatory feature or essential plant room, area of which is NOT limited by any PNAP or regulation such as room occupied solely by fire services installations (FSI) and equipment, meter room, transformer room, potable and flushing water tank, etc. 所佔面積不受任何《認可人士、註冊結構工程師及註冊岩土工程師作業備考》或規例限制的強制性設施或必要機房，例如僅供消防裝置及設備佔用的房間、電錶房、電力變壓房、食水及鹹水缸等	3,814.323 (Domestic)(住用) 252.358 (Non-Domestic)(非住用)
2.3	Non-mandatory or non-essential plant room such as air-conditioning plant room, air handling unit (AHU) room, etc. 非強制性或非必要機房，例如空調機房、風櫃房等	Not Applicable 不適用
Green Features under Joint Practice Notes 1 and 2 根據聯合作業備考第1及第2號提供的環保設施		
3.	Balcony 露台	1,444.009 (Domestic)(住用)
4.	Wider common corridor and lift lobby 加闊的公用走廊及升降機大堂	991.539 (Domestic)(住用)
5.	Communal sky garden 公用空中花園	Not Applicable 不適用
6.	Acoustic fin 隔聲鰭	Not Applicable 不適用
7.	Wing wall, wind catcher and funnel 翼牆、捕風器及風斗	Not Applicable 不適用
8.	Non-structural prefabricated external wall 非結構預製外牆	232.808 (Domestic)(住用)
9.	Utility platform 工作平台	875.250 (Domestic)(住用)
10.	Noise barrier 隔音屏障	Not Applicable 不適用

Information in application for concession on gross floor area of building
申請建築物總樓面面積寬免的資料

		Area (m ²) 面積 (平方米)
Amenity Features 適意設施		
11.	Counter, office, store, guard room and lavatory for watchman and management staff, Owners' Corporation Office 供保安人員和管理處員工使用的櫃枱、辦公室、儲物室、警衛室和廁所、業主立案法團辦公室	Not Applicable 不適用
12.	Residential Recreational facilities including void, plant room, swimming pool filtration plant room, covered walkway etc. serving solely the recreational facilities 住宅康樂設施，包括僅供康樂設施使用的中空、機房、游泳池的濾水器機房、有蓋人行道等	1,151.072 (Domestic)(住用)
13.	Covered landscaped and play area 有上蓋的園景區及遊樂場	1,166.141 (Domestic)(住用)
14.	Horizontal screens / covered walkways, trellis 橫向屏障/有蓋人行道、花棚	190.451 (Domestic)(住用)
15.	Larger lift shaft 擴大升降機井道	3,297.368 (Domestic)(住用)
16.	Chimney shaft 煙囪管道	Not Applicable 不適用
17.	Other non-mandatory or non-essential plant room, such as boiler room, satellite master antenna television (SMATV) room 其他非強制性或非必要機房，例如鍋爐房、衛星電視共用天線房	1.435 (Domestic)(住用) 1.595 (Non-Domestic)(非住用)
18.	Pipe duct, air duct for mandatory feature or essential plant room 強制性設施或必要機房所需的管槽、氣槽	1,725.516 (Domestic)(住用) 13.826 (Non-Domestic)(非住用)
19.	Pipe duct, air duct for non-mandatory or non-essential plant room 非強制性設施或非必要機房所需的管槽、氣槽	Not Applicable 不適用
20.	Plant room, pipe duct, air duct for environmentally friendly system and feature 環保系統及設施所需的機房、管槽及氣槽	Not Applicable 不適用
21.	Void in duplex domestic flat and house 複式住宅單位及洋房的中空	Not Applicable 不適用
22.	Projections such as air-conditioning box and platform with a projection of more than 750 mm from the external wall 伸出物，如空調機箱及伸出外牆超過750毫米的平台	Not Applicable 不適用
Other Exempted Items 其他獲豁免的項目		
23.	Refuge floor including refuge floor cum sky garden 庇護層，包括庇護層兼空中花園	582.051 (Domestic)(住用)
24.	Other projections 其他伸出物	3,668.182 (Domestic)(住用)
25.	Public transport terminus 公共交通總站	Not Applicable 不適用
26.	Party structure and common staircase 共用構築物及樓梯	Not Applicable 不適用
27.	Horizontal area of staircase, lift shaft and vertical duct solely serving floor accepted as not being accountable for GFA 僅供獲接納不計入總樓面面積的樓層使用的樓梯、升降機槽及垂直管道的水平面積	491.133 (Domestic)(住用) 308.988 (Non-Domestic)(非住用)

Information in application for concession on gross floor area of building
申請建築物總樓面面積寬免的資料

		Area (m ²) 面積 (平方米)
28.	Public passage 公眾通道	Not Applicable 不適用
29.	Covered set back area 因建築物後移導致的覆蓋面積	Not Applicable 不適用
Bonus GFA 額外總樓面面積		
30.	Bonus GFA 額外總樓面面積	Not Applicable 不適用

Note: The above table is based on the requirements as stipulated in the Practice Note for Authorized Persons, Registered Structural Engineers and Registered Geotechnical Engineers ADM-2 issued by the Buildings Department. The Buildings Department may revise such requirements from time to time as appropriate.

註： 上述表格是根據屋宇署所發出的《認可人士、註冊結構工程師及註冊岩土工程師作業備考》ADM-2規定的要求而制訂的。屋宇署會按實際需要不時更改有關要求。

Information in application for concession on gross floor area of building 申請建築物總樓面面積寬免的資料

Environmental Assessment of the Building 建築物的環境評估



Estimated Energy Performance or Consumption for the Common Parts of the Phase 期數的公用部分的預計能量表現或消耗

Latest information on the estimated energy performance or consumption for the common parts of the Phase as submitted to the Building Authority prior to the printing of the sales brochures:
於印製售樓說明書前呈交予建築事務監督期數的公用部份的預計能量表現或消耗的最近期資料：

Part I 第I部分	
Provision of Central Air Conditioning 提供中央空調	—
Provision of Energy Efficient Features 提供具能源效益的設施	—
Energy Efficient Features proposed 擬安裝的具能源效益的設施	—

Part II : The predicted annual energy use of the proposed building / part of building ^(Note 1) 第II部分：擬興建樓宇/部分樓宇預計每年能源消耗量 ^(註腳1)					
Location 位置	Internal Floor Area Served (m ²) 使用有關裝置的內部樓面面積 (平方米)	Annual Energy Use of Baseline Building ^(Note 2) 基線樓宇 ^(註腳2) 每年能源消耗量		Annual Energy Use of Proposed Building 擬興建樓宇每年能源消耗量	
		Electricity kWh/m ² /annum 電力 千瓦小時/平方米/年	Town Gas / LPG unit/m ² /annum 煤氣/石油氣 用量單位/平方米/年	Electricity kWh/m ² /annum 電力 千瓦小時/平方米/年	Town Gas / LPG unit/m ² /annum 煤氣/石油氣 用量單位/平方米/年
Area served by central building services installation ^(Note 3) 有使用中央屋宇裝備裝置 ^(註腳3) 的部分	24,913.661	83.580	-	53.830	-

Information in application for concession on gross floor area of building 申請建築物總樓面面積寬免的資料

Part III : The following installation(s) are designed in accordance with the relevant Codes of Practices published by the Electrical & Mechanical Services Department (EMSD) 第III部分：以下裝置乃按機電工程署公布的相關實務守則設計			
Type of Installations 裝置類型	YES 是	NO 否	N/A 不適用
Lighting Installations 照明裝置	✓	-	-
Air Conditioning Installations 空調裝置	✓	-	-
Electrical Installations 電力裝置	✓	-	-
Lift & Escalator Installations 升降機及自動梯的裝置	✓	-	-
Performance-based Approach 以總能源為本的方法	-	-	✓

Notes:

- In general, the lower the estimated "Annual Energy Use" of the building, the more efficient of the building in terms of energy use. For example, if the estimated "annual energy use of proposed building" is less than the estimated "annual energy use of baseline building", it means the predicted use of energy is more efficient in the proposed building than in the baseline building. The larger the reduction, the greater the efficiency. The predicted annual energy use, in terms of electricity consumption (kWh/m²/annum) and town gas/LPG consumption (unit/m²/annum), of the development by the internal floor area served, where: (a) "total annual energy use" has the same meaning of "annual energy use" under Section 4 and Appendix 8 of the BEAM Plus for New Buildings (current version); and (b) "internal floor area", in relation a building, a space or a unit means the floor area of all enclosed space measured to the internal faces of enclosing external and/or party walls.
- "Baseline Building" has the same meaning as "Baseline Building Model (zero-credit benchmark)" under Section 4 and Appendix 8 of the BEAM Plus for New Building (current version).
- "Central Building Services Installation" has the same meaning as that in the Code of Practice for Energy Efficiency of Building Services Installations in Buildings issued by the Electrical & Mechanical Services Department.

註腳：

- 一般而言，一棟樓宇的預計“每年能源消耗量”愈低，其節約能源的效益愈高。如一棟樓宇預計的“每年能源消耗量”低於該樓宇的“基線樓宇每年能源消耗量”，則代表預計該樓宇的能源應用較其基線樓宇有效，削減幅度愈大則代表有關樓宇能源節約的效益愈高。
預計每年能源消耗量[以耗電量(千瓦小時/平方米/年)及煤氣/石油氣消耗量(用量單位/平方米/年)計算]，指將發展項目的每年能源消耗總量除以使用有關裝置的內部樓面面積所得出的商，其中：-
(a) “每年能源消耗量”與新建樓宇 BEAM Plus 標準(現行版本)第4節及附錄8中的「年能源消耗」具有相同涵義；及
(b) 樓宇、空間或單位的“內部樓面面積”，指外牆及/或共用牆的內壁之內表面起量度出來的樓面面積。
- “基準樓宇”與新建樓宇 BEAM Plus 標準(現行版本)第4節及附錄8中的“基準建築物模式(零分標準)”具有相同涵義。
- “中央屋宇裝備裝置”與由機電工程署發出的樓宇的屋宇裝備裝置能源效益實務守則中的涵義相同。

Information required by the Director of Lands to be set out in the sales brochure as a condition for giving the presale consent 地政總署署長作為給予預售樓花同意書的條件而規定列於售樓說明書的資料

1. The purchaser is required to agree with MTR Corporation Limited ("the Vendor") in the Agreement for Sale and Purchase ("ASP") to the effect that other than entering into a mortgage or charge, the purchaser will not nominate any person to take up the Assignment of the Residential Unit or the Parking Space specified in the ASP, sub-sell that Residential Unit or Parking Space or transfer the benefit of the ASP of that Residential Unit or Parking Space in any manner whatsoever or enter into any agreement so to do before completion of the sale and purchase and execution of the Assignment.
 2. If the Vendor, at the request of the purchaser under an ASP, agrees (at its own discretion) to cancel the ASP or the obligations of the purchaser under the ASP, the Vendor is entitled to retain the sum of five percent (5%) of the total purchase price of the Residential Unit and the Parking Space specified in the ASP and the purchaser will in addition pay or reimburse (as the case may be) to the Vendor all legal costs, charges and disbursements (including any stamp duty) in connection with the cancellation of the ASP.
 3. The Vendor will pay or has paid (as the case may be) all outstanding Government rent in respect of the land on which the Development is in the course of being erected, from the date of the Government Grant up to and including the date of the respective Assignments to the purchasers.
 4. The purchaser who has signed an ASP has the right of access to and will, upon his request, be provided with a hard copy of an updated record of information as to the total construction costs and the total professional fees to complete the Phase as well as the total construction costs and the total professional fees expended and paid as at the end of the calendar month preceding the month at which the request is made subject to payment of a nominal fee of not more than HK\$100 per request.
 5. Information relating to the Green Areas (as referred to in Special Condition No.(5) of the Government Grant) :-

Please refer to the sections "Summary of Land Grant" and "Information on Public Facilities and Public Open Spaces" of this sales brochure.
 6. Information relating to the Bicycle Park (as referred to in Special Condition No.(20)(a) of the Government Grant), the Cycle Track (as referred to in Special Condition No.(21)(a) of the Government Grant), the Tai Wai Station (as referred to in Special Condition No.(28)(a) of the Government Grant), the Covered Footbridges (as referred to in Special Condition No.(35)(a)(i) of the Government Grant), the Existing Footbridge and the Existing Footbridge Supports, Connections and Extensions (as referred to in Special Condition No.(35)(a)(ii) of the Government Grant), the 24-hour Walkway (as referred to in Special Condition No.(36)(d)(i) of the Government Grant), the PSC Lay-bys (as referred to in Special Condition No.(49)(a) of the Government Grant) and the Public Lay-By (as referred to in Special Condition No.(50)(a) of the Government Grant) :-

Please refer to the sections "Summary of Land Grant" and "Information on Public Facilities and Public Open Spaces" of this sales brochure.
 7. Information relating to the Existing Public Toilet (as referred to in Special Condition No.(16) of the Government Grant), the Existing PTI (as referred to in Special Condition No.(17) of the Government Grant), the New PTI (as referred to in Special Condition No.(18) of the Government Grant) and the PSC (as referred to in Special Condition No.(22) of the Government Grant) :-

Please refer to the sections "Summary of Land Grant" and "Information on Public Facilities and Public Open Spaces" of this sales brochure.
1. 買方須於正式買賣合約（「買賣合約」）下與香港鐵路有限公司（「賣方」）約定，除訂立按揭或押記外，在買賣完成及簽署轉讓契前，買方不得提名任何人士接受買賣合約指明之住宅單位或停車位之轉讓、轉售該住宅單位或停車位或以任何形式轉移該住宅單位或停車位之買賣合約之權益、或訂立任何有關上述提名、轉售或轉移權益之協議。
 2. 若賣方應買賣合約下買方要求同意（同意與否賣方有酌情權決定）取消買賣合約或買賣合約下買方之責任，賣方有權保留等同買賣合約指明之住宅單位及停車位總售價5%之金額，另買方須向賣方繳付或補還（視屬何情況而定）所有與取消買賣合約有關之法律費用、收費及開銷（包括任何印花稅）。
 3. 賣方將會或已經（視屬何情況而定）支付所有有關發展項目在其上興建之土地於批地文件日期起計至相關買家轉讓契日期（包括該兩日）期間之未付地稅。
 4. 已簽署買賣合約之買方，如已支付不多於港幣\$100之象徵式費用（按每次要求計），有權獲取（而當其要求時將獲提供）以下資料之最新紀錄印本：完成期數的總建築費用及總專業費用及截至該要求作出當月前之月份完結時已支出和繳付之總建築費用及總專業費用。
 5. 有關綠色區域（在批地文件特別條件第(5)條所提及）的資料：

請參閱本售樓說明書的「批地文件的摘要」及「公共設施及公眾休憩用地的資料」兩節。
 6. 有關單車停車場（在批地文件特別條件第(20)(a)條所提及）、單車徑（在批地文件特別條件第(21)(a)條所提及）、大圍站（在批地文件特別條件第(28)(a)條所提及）、有蓋行人天橋（在批地文件特別條件第(35)(a)(i)條所提及）、現有行人天橋及現有行人天橋的支撐物、連接物及延伸物（在批地文件特別條件第(35)(a)(ii)條所提及）、24小時行人道（在批地文件特別條件第(36)(d)(i)條所提及）、專上學院停車處（在批地文件特別條件第(49)(a)條所提及）及公共停車處（在批地文件特別條件第(50)(a)條所提及）的資料：

請參閱本售樓說明書的「批地文件的摘要」及「公共設施及公眾休憩用地的資料」兩節。
 7. 有關現有公廁（在批地文件特別條件第(16)條所提及）、現有公共運輸交匯處（在批地文件特別條件第(17)條所提及）、新的公共運輸交匯處（在批地文件特別條件第(18)條所提及）及專上學院（在批地文件特別條件第(22)條所提及）的資料：

請參閱本售樓說明書的「批地文件的摘要」及「公共設施及公眾休憩用地的資料」兩節。

There may be future changes to the Phase and the surrounding areas.
期數及其周邊地區日後可能出現改變。

Date of Printing: 22 October 2020
印製日期：2020年10月22日

